

Programmer Manual



RSA3408A **8 GHz Real-Time Spectrum Analyzer** **077-0003-04**

This document applies to firmware version 3.31
and above.

www.tektronix.com

Copyright © Tektronix. All rights reserved. Licensed software products are owned by Tektronix or its subsidiaries or suppliers, and are protected by national copyright laws and international treaty provisions.

Tektronix products are covered by U.S. and foreign patents, issued and pending. Information in this publication supercedes that in all previously published material. Specifications and price change privileges reserved.

TEKTRONIX and TEK are registered trademarks of Tektronix, Inc.

Contacting Tektronix

Tektronix, Inc.
14200 SW Karl Braun Drive
P.O. Box 500
Beaverton, OR 97077
USA

For product information, sales, service, and technical support:

- In North America, call 1-800-833-9200.
- Worldwide, visit www.tektronix.com to find contacts in your area.

Table of Contents

Preface	xi
Related Manual	xi

Getting Started

Overview of the Manual	1-2
Connecting the Interface	1-4
Using the GPIB Port	1-5
Setting the GPIB Parameters from the Front Panel	1-6
Using TekVISA	1-8

Syntax and Commands

Command Syntax	2-1
Backus-Naur Form Definition	2-1
SCPI Commands and Queries	2-2
IEEE 488.2 Common Commands	2-10
Constructed Mnemonics	2-11
Command Groups	2-13
Measurement Mode	2-13
Functional Groups	2-15
IEEE Common Commands	2-16
:ABORt Commands	2-16
:CALCulate Commands	2-17
:CALibration Commands	2-18
:CONFigure Commands	2-18
:CONFigure Commands (Option)	2-19
:DISPlay Commands	2-21
:DISPlay Commands (Option)	2-25
:FETCh Commands	2-43
:FETCh Commands (Option)	2-44
:FORMat Commands	2-48
:HCOPy Commands	2-48
:INITiate Commands	2-49
:INPut Commands	2-49
:INSTrument Commands	2-49
:MMEMory Commands	2-50
:OUTPut Commands	2-51
:PROGram Commands	2-51
:READ Commands	2-51
:READ Commands (Option)	2-52
:SENSe Commands	2-55
:SENSe Commands (Option)	2-59
:STATus Commands	2-76
:SYSTem Commands	2-76
:TRACe Commands	2-77
:TRIGger Commands	2-77
:UNIT Commands	2-78

IEEE Common Commands	2-79
:ABORt Commands	2-89
:CALCulate Commands	2-91
:CALibration Commands	2-107
:CONFigure Commands	2-119
:CONFigure Commands (Option)	2-131
:DISPlay Commands	2-183
:DISPlay Commands (Option)	2-249
:FETCh Commands	2-659
:FETCh Commands (Option)	2-687
:FORMat Commands	2-865
:HCOPy Commands	2-867
:INITiate Commands	2-871
:INPut Commands	2-875
:INSTrument Commands	2-881
:MMEMory Commands	2-885
:OUTPut Commands	2-909
:PROGram Commands	2-911
:READ Commands	2-917
:READ Commands (Option)	2-945
:SENSe Commands	2-1035
:SENSe Commands (Option)	2-1119
:STATus Commands	2-1519
:SYSTem Commands	2-1527
:TRACe Commands	2-1537
:TRIGger Commands	2-1543
:UNIT Commands	2-1555
Retrieving Response Message	2-1557

Status and Events

Status and Event Reporting System	3-1
Registers	3-5
Status Registers	3-5
Enable Registers	3-9
Transition Registers	3-11
Queues	3-12
Status and Event Processing Sequence	3-13
Synchronizing Execution	3-14

Error Messages and Codes	3-17
Command Errors	3-18
Execution Errors	3-20
Device Specific Errors	3-22
Query Errors	3-22

Programming Examples

General Programming Procedure	4-2
Application Program Sample	4-3
Macro Program Execution Sample	4-15

Appendices

Appendix A: Character Charts	A-1
Appendix B: GPIB Interface Specification	B-1
Interface Functions	B-1
Interface Messages	B-3
Appendix C: Factory Initialization Settings	C-1
Appendix D: Setting Range	D-1
Scale Setting Range	D-1
RBW	D-8
Appendix E: SCPI Conformance Information	E-1

Glossary and Index

List of Figures

Figure 1-1: Command parts	1-2
Figure 1-2: Functional groupings and an alphabetical list of commands	1-2
Figure 1-3: Event-driven program	1-3
Figure 1-4: Sample program (Visual C++ source code)	1-3
Figure 1-5: GPIB connector (rear panel)	1-4
Figure 1-6: GPIB connection	1-5
Figure 1-7: Typical GPIB network configurations	1-5
Figure 1-8: Remote Setup menu	1-6
Figure 1-9: Setting the GPIB parameters	1-7
Figure 2-1: Example of SCPI subsystem hierarchy tree	2-2
Figure 2-2: Example of abbreviating a command	2-6
Figure 2-3: Example of chaining commands and queries	2-7
Figure 2-4: Example of omitting root and lower-level nodes in a chained message	2-7
Figure 2-5: View number assignments	2-91
Figure 2-6: Horizontal scale setting requirements	2-184
Figure 2-7: Horizontal scale setting requirements for spectrum view	2-185
Figure 2-8: :DISPlay:CCDF command setting	2-186
Figure 2-9: :DISPlay:OView command setting	2-193
Figure 2-10: :DISPlay:PULSe:SPECTrum command setting	2-215
Figure 2-11: :DISPlay:SPECTrum command setting	2-224
Figure 2-12: :DISPlay:TFRequency command setting	2-234
Figure 2-13: View display formats	2-244
Figure 2-14: :DISPlay:WAVEform command setting	2-245
Figure 2-15: :DISPlay:DDEMod command setting	2-253
Figure 2-16: :DISPlay:AC3Gpp command setting	2-340
Figure 2-17: :DISPlay:UL3Gpp command setting	2-345
Figure 2-18: Setting up the ACPR measurement	2-1038
Figure 2-19: Defining the analysis range	2-1041
Figure 2-20: Setting up the channel power measurement	2-1057
Figure 2-21: Setting up the C/N measurement	2-1060
Figure 2-22: Setting up the EBW measurement	2-1070
Figure 2-23: Setting frequency and span	2-1072

Figure 2-24: Setting up the OBW measurement	2-1081
Figure 2-25: Setting up the spurious signal measurement	2-1112
Figure 2-26: Defining the analysis range	2-1115
Figure 2-27: Defining the analysis range	2-1123
Figure 2-28: Trigger mask setting example	2-1546
Figure 2-29: Retrieving response message	2-1557
Figure 3-1: Status/Event reporting mechanism	3-2
Figure 3-2: The Status Byte Register (SBR)	3-6
Figure 3-3: The Standard Event Status Register (SESR)	3-7
Figure 3-4: The Operation Condition Register (OCR)	3-8
Figure 3-5: The Event Status Enable Register (ESER)	3-9
Figure 3-6: The Service Request Enable Register (SRER)	3-10
Figure 3-7: Operation Enable Register (OENR)	3-10
Figure 3-8: Operation Transition Register (OTR)	3-11
Figure 3-9: Status and event processing sequence	3-13
Figure 4-1: Saving the macro programs	4-15

List of Tables

Table 2-1: BNF symbols and meanings	2-1
Table 2-2: Query response examples	2-3
Table 2-3: Parameter types used in syntax descriptions	2-4
Table 2-4: Available units	2-8
Table 2-5: Available SI prefixes	2-8
Table 2-6: Constructed mnemonics	2-11
Table 2-7: Measurement mode	2-13
Table 2-8: List of command groups	2-15
Table 2-9: IEEE common commands	2-16
Table 2-10: :ABORt commands	2-16
Table 2-11: :CALCulate commands	2-17
Table 2-12: :CALibration commands	2-18
Table 2-13: :CONFigure commands	2-18
Table 2-14: :CONFigure commands (Option)	2-19
Table 2-15: :DISPlay commands	2-21
Table 2-16: :DISPlay commands (Option)	2-25
Table 2-17: :FETCh commands	2-43
Table 2-18: :FETCh commands (Option)	2-44
Table 2-19: :FORMat commands	2-48
Table 2-20: :HCOPy commands	2-48
Table 2-21: :INITiate commands	2-49
Table 2-22: :INPut commands	2-49
Table 2-23: :INSTrument commands	2-49
Table 2-24: :MMEMory commands	2-50
Table 2-25: :PROGram commands	2-51
Table 2-26: :PROGram commands	2-51
Table 2-27: :READ commands	2-51
Table 2-28: :READ commands (Option)	2-52
Table 2-29: :SENSE commands	2-55
Table 2-30: :SENSE commands (Option)	2-59
Table 2-31: :STATus commands	2-76
Table 2-32: :SYSTem commands	2-76
Table 2-33: :TRACe commands	2-77
Table 2-34: :TRIGger commands	2-77
Table 2-35: :UNIT commands	2-78

Table 2-36: :CONFigure command subgroups (Option)	2-131
Table 2-37: :DISPlay command subgroups	2-183
Table 2-38: Subview display format	2-211
Table 2-39: :DISPlay command subgroups (Option)	2-249
Table 2-40: Main view display formats	2-256
Table 2-41: Subview display formats	2-270
Table 2-42: Subview display formats	2-292
Table 2-43: Subview display formats in the signal source analysis .	2-318
Table 2-44: Symbol rate settings	2-347
Table 2-45: Main view display formats	2-350
Table 2-46: Subview display formats	2-358
Table 2-47: Main view display formats	2-367
Table 2-48: Subview display formats	2-374
Table 2-49: Display format of the main view	2-399
Table 2-50: Display format in the subview	2-405
Table 2-51: Display format of the main view	2-426
Table 2-52: Display format in the subview	2-432
Table 2-53: Symbol rate settings	2-449
Table 2-54: 3GPP-R5 downlink modulation analysis display formats	2-453
Table 2-55: Symbol rate settings	2-469
Table 2-56: 3GPP-R5 uplink modulation analysis display formats	2-473
Table 2-57: Subview display formats, MIMO	2-524
Table 2-58: Subview display formats, nx1	2-561
Table 2-59: Subview display formats	2-599
Table 2-60: Symbol rate settings	2-619
Table 2-61: 3GPP-R6 downlink modulation analysis display formats	2-623
Table 2-62: Symbol rate settings	2-642
Table 2-63: 3GPP-R6 uplink modulation analysis display formats	2-646
Table 2-64: Queried information	2-670
Table 2-65: :FETCh command subgroups (Option)	2-687
Table 2-66: Queried information on the digital modulation analysis results	2-689
Table 2-67: RFID measurement selections	2-695
Table 2-68: Symbol value definition	2-698
Table 2-69: Signal source analysis	2-705
Table 2-70: Queried information on the W-CDMA uplink analysis results	2-715

Table 2-71: The n value for CDPower	2-756
Table 2-72: The n value for IQPower	2-756
Table 2-73: The n value for MACCuracy	2-763
Table 2-74: The n value for STABLE	2-764
Table 2-75: Queried information on the 3GPP-R5 downlink analysis results	2-777
Table 2-76: Queried information on the 3GPP-R5 uplink analysis results	2-798
Table 2-77: Queried information	2-827
Table 2-78: Queried information	2-834
Table 2-79: Queried information	2-842
Table 2-80: Queried information on the 3GPP-R6 downlink analysis results	2-851
Table 2-81: Queried information on the 3GPP-R6 uplink analysis results	2-857
Table 2-82: Reference level range	2-879
Table 2-83: Measurement mode	2-882
Table 2-84: Item to save (Option 40)	2-901
Table 2-85: Content to save (Option 40)	2-902
Table 2-86: File header contents - Option 21, 23, 27, 28, and 40	2-905
Table 2-87: File header contents - Option 25, 26, and 29	2-906
Table 2-88: :READ command subgroups (Option)	2-945
Table 2-89: Queried information on the digital modulation analysis results	2-948
Table 2-90: Signal source analysis	2-959
Table 2-91: :SENSE command subgroups	2-1035
Table 2-92: Measurement item selections	2-1046
Table 2-93: Block size setting range	2-1051
Table 2-94: Measurement frequency bands	2-1073
Table 2-95: Span setting	2-1078
Table 2-96: FFT windows	2-1105
Table 2-97: S/A mode measurement items	2-1107
Table 2-98: :SENSE command subgroups (Option)	2-1119
Table 2-99: Modulation selections	2-1130
Table 2-100: Communication standard selections	2-1139
Table 2-101: RFID measurement items	2-1151
Table 2-102: Decoding format	2-1157
Table 2-103: Modulation format	2-1158
Table 2-104: RFID demodulation standard	2-1162

Table 2-105: Analysis length setting range	2-1182
Table 2-106: SSource measurement items	2-1183
Table 2-107: GSM/EDGE measurement items	2-1214
Table 2-108: Measurement item selections	2-1224
Table 2-109: Code range	2-1238
Table 2-110: Walsh code length selections	2-1240
Table 2-111: Code range	2-1258
Table 2-112: Walsh code length selections	2-1260
Table 2-113: Code range	2-1268
Table 2-114: Walsh code length selections	2-1270
Table 2-115: Measurement item selections	2-1289
Table 2-116: Code range	2-1304
Table 2-117: Code range	2-1325
Table 2-118: Code range	2-1336
Table 2-119: Measurements, 802.11n MIMO	2-1462
Table 2-120: Measurements, 802.11n (nx1)	2-1473
Table 2-121: Modulation type selections	2-1482
Table 2-122: Measurement selections	2-1485
Table 2-123: Configuration in 3GPP-R6	2-1507
Table 2-124: DPCCH format	2-1508
Table 2-125: Bin number setting range	2-1545
Table 3-1: SBR bit functions	3-6
Table 3-2: SESR bit functions	3-7
Table 3-3: OCR bit functions	3-8
Table 3-4: Command errors	3-18
Table 3-5: Execution errors	3-20
Table 3-6: Device specific errors	3-22
Table 3-7: Query errors	3-22
Table A-1: ASCII & GPIB code chart	A-2
Table B-1: GPIB interface function implementation	B-1
Table B-2: Standard interface messages	B-3
Table C-1: IEEE common commands	C-1
Table C-2: :CALibration commands	C-1
Table C-3: :DISPlay commands	C-1
Table C-4: :DISPlay commands (Option)	C-3

Table C-5: :FORMat commands	C-7
Table C-6: :INITiate commands	C-8
Table C-7: :INPut commands	C-8
Table C-8: :SENSe commands	C-8
Table C-9: :SENSe commands (Option)	C-11
Table C-10: :STATus commands	C-28
Table C-11: :TRACe commands	C-28
Table C-12: :TRIGger commands	C-28
Table C-13: :UNIT commands	C-29
Table D-1: Display format and scale	D-1
Table D-2: Display format and scale: Digital modulation analysis (Option 21)	D-1
Table D-3: Display format and scale: RFID Measurements (Option 21)	D-2
Table D-4: Display format and scale: Signal source analysis (Option 21)	D-3
Table D-5: W-CDMA (Option 23), 3GPP-R5 (Option 27), and 3GPP-R6 (Option 40) analyses	D-4
Table D-6: Display format and scale, cdma2000 analysis (Option 25)	D-4
Table D-7: Display format and scale, 1xEV-DO analysis (Option 26)	D-5
Table D-8: Display format and scale, TD-SCDMA analysis (Option 28)	D-6
Table D-9: Display format and scale, WLAN analysis (Option 29)	D-7
Table D-10: RBW setting range	D-8
Table E-1: SCPI 1999.0-defined commands	E-1

Preface

This programmer manual is for the RSA3408A 8 GHz Real-Time Spectrum Analyzer. It provides information on operating your analyzer using the General Purpose Interface Bus (GPIB).

This manual is composed of the following sections:

- *Getting Started* outlines how to use the GPIB interface.
- *Syntax and Commands* defines the syntax used in command descriptions, presents a list of all command subsystems, and presents detailed descriptions of all programming commands.
- *Status and Events* describes how the status and Events Reporting system operates and presents a list of all system errors.
- *Programming Examples* describes some example analyzer programs.
- *Appendices* provides additional information including character charts, GPIB interface specification, and factory initialization settings.

Related Manual

RSA3408A User Manual

(Standard accessory, Tektronix part number 071-1617-XX)

Describes how to install the analyzer and how to work with the menus and details the functions.

Getting Started

Getting Started

You can write computer programs that remotely set the analyzer front panel controls or that take measurements and read those measurements for further analysis or storage.

To help you get started with programming the analyzer, this section includes the following sections:

- *Overview of the Manual*
Summarizes the type of programming information contained in each major section of this manual.
- *Connecting the Interface*
Describes how to physically connect the analyzer to a controller.
- *Using GPIB Ports*
Describes how to use the GPIB port.
- *Setting the GPIB Parameters from the Front Panel*
Describes how to set the GPIB parameters from the front panel.
- *Using TekVISA*
Describes how to use the TekVISA communication protocol.

Overview of the Manual

The information contained in each major section of this manual is described below.

Syntax and Commands

Section 2, *Syntax and Commands*, describes the structure and content of the messages your program sends to the analyzer. Figure 1-1 shows command parts as described in the *Command Syntax* subsection.

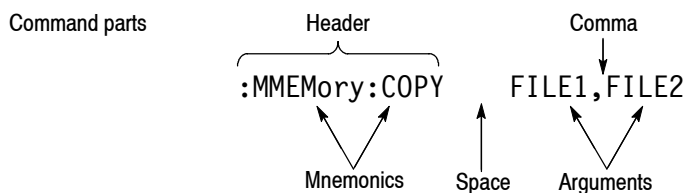

Figure 1-1: Command parts

Section 2 also describes the effect of each command and provides examples of how you might use it. The *Command Groups* section provides lists by functional areas. The *IEEE Common Commands* and the subsequent sections arrange commands alphabetically (Figure 1-2).

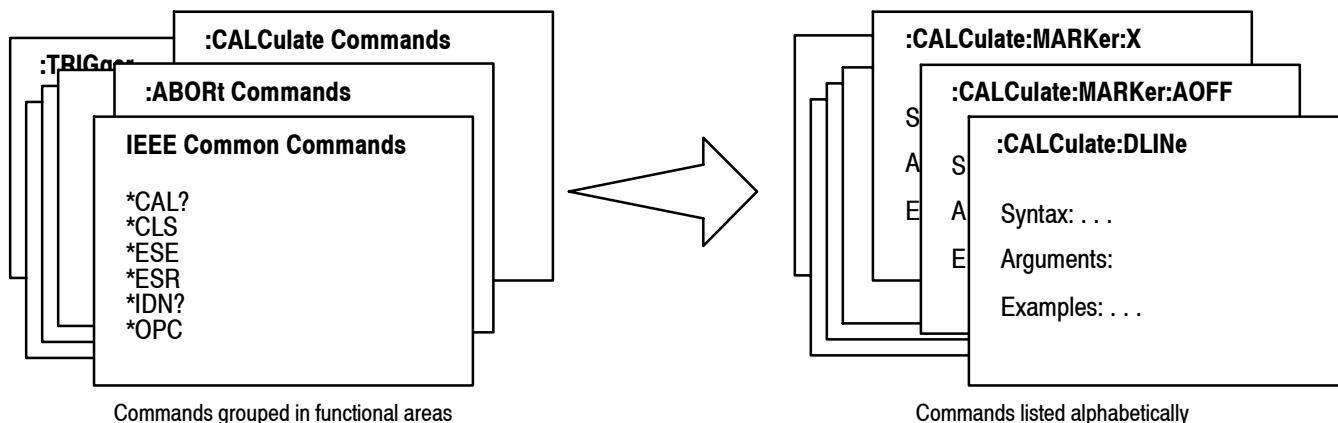

Figure 1-2: Functional groupings and an alphabetical list of commands

Status and Events

The program may request information from the analyzer. The analyzer provides information in the form of status and error messages. Figure 1-3 illustrates the basic operation of this system.

Section 3, *Status and Events*, describes how to get status or event information from the program and details the event and error messages.

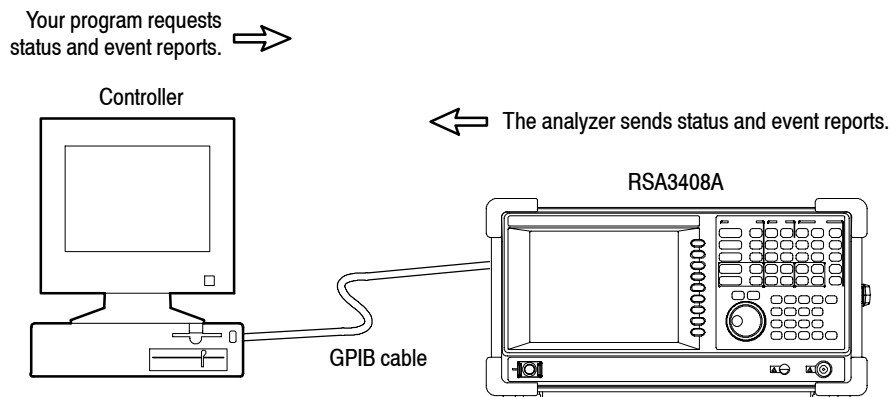

Figure 1-3: Event-driven program

Programming Examples

Section 4, *Programming Examples*, includes Visual C++ source code as well as sample programs for running macro programs.

```

{
GpibWrite("INSTRUMENT 'SANORMAL'");
GpibWrite("*RST");
GpibTimeout(NORMAL_TIME);
GpibWrite("CONFIGure:SPECTrum:CHPower");
GpibWrite("FREQuency:BAND RF1B");
GpibWrite("FREQuency:CENTer 1GHz");
GpibWrite("FREQuency:SPAN 1MHz");
GpibWrite("*CAL?");
GpibRead(readBuf, MAX_BUF);
printf("*CAL? result = %s\n", readBuf);
GpibWrite("CHPower:BANDwidth:INTEgration 300kHz");
GpibWrite("SPECTrum:AVERage ON");
}

```

Figure 1-4: Sample program (Visual C++ source code)

Connecting the Interface

The analyzer has a 24-pin GPIB connector on its rear panel, as shown in Figure 1-5. This connector has a D-type shell and conforms to IEEE Std 488.1-1987.

Attach an IEEE Std 488.1-1987 GPIB cable (Tektronix part number 012-0991-00) to this connector.

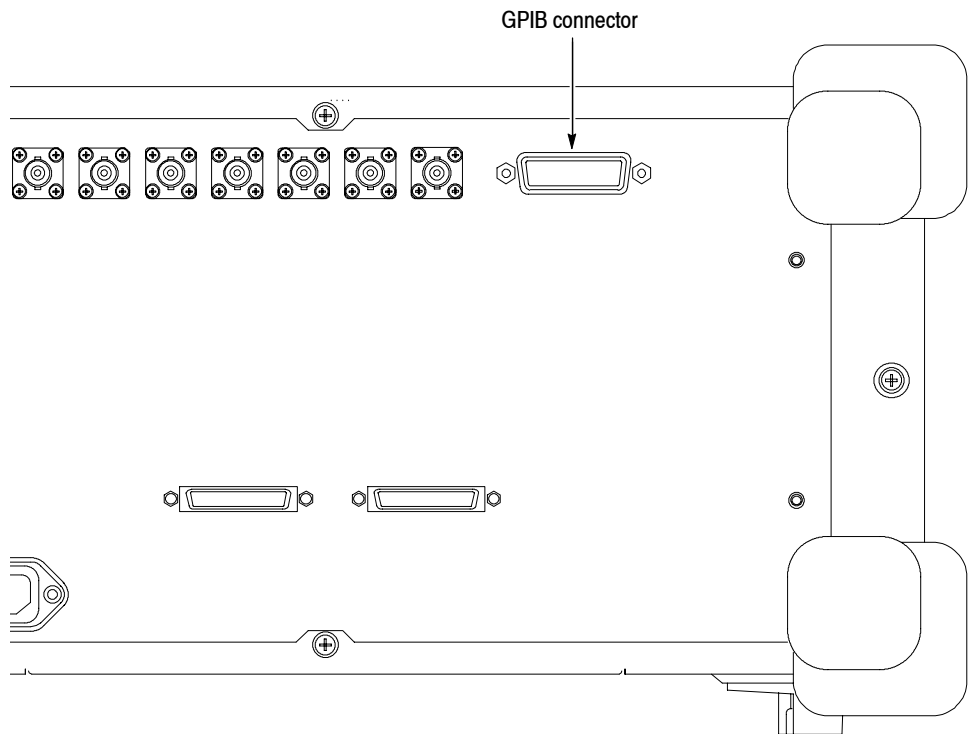

Figure 1-5: GPIB connector (rear panel)

Appendix B: GPIB Interface Specifications gives more information on the GPIB configuration of the analyzer.

For the other interfaces, refer to the *RSA3408A User Manual*.

Using the GPIB Port

The analyzer has Talker/Listener functions through which it can communicate with other devices, as well as the external controller, located on the bus.

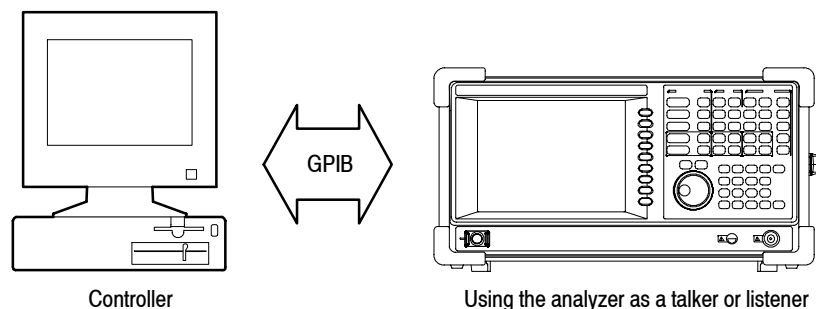

Figure 1-6: GPIB connection

GPIB Requirements

Observe these rules when you use your analyzer with a GPIB network:

- Assign a unique device address to each device on the bus. No two devices can share the same device address.
- Do not connect more than 15 devices to any one bus.
- Connect one device for every 2 meters (6 feet) of cable used.
- Do not use more than 20 meters (65 feet) of cable to connect devices to a bus.
- Turn on at least two-thirds of the devices on the network while using the network.
- Connect the devices on the network in a star or linear configuration as shown in Figure 1-7. Do not use loop or parallel configurations.

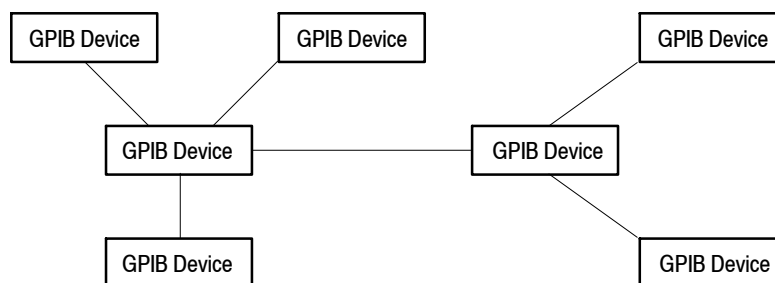

Figure 1-7: Typical GPIB network configurations

Setting the GPIB Parameters from the Front Panel

Use the **SYSTEM** → **Remote Setup** menu to set the GPIB parameters as required for the bus configuration. Once you have set the parameters, you can control the analyzer through the GPIB interface.

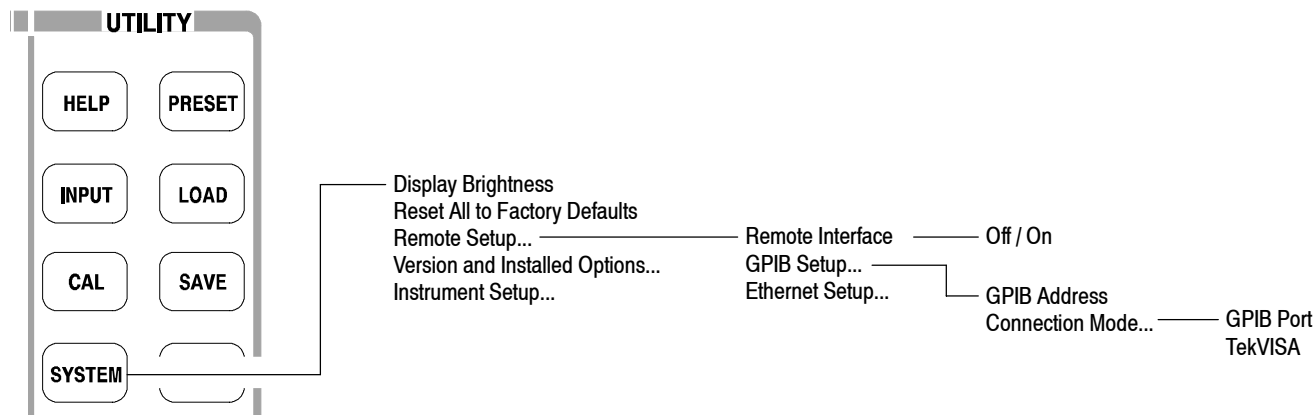

Figure 1-8: Remote Setup menu

Remote Setup Menu

The Remote Setup menu contains the following controls:

Remote Interface. Turns on or off the connection between the analyzer and the interface bus.

GPIB Setup... Sets the GPIB address and connection mode.

GPIB Address. Sets the GPIB address of the analyzer when GPIB Port is selected as the Connection Mode. Range: 0 to 30 (default: 1)

Connection Mode. Selects the physical GPIB port or the virtual (TekVISA) connection method.

- **GPIB Port.** *Default.* Uses the IEEE488.2 connector on the rear panel of the analyzer to communicate with an external controller. Refer to the next section *Setting up the GPIB port* for the procedure.
- **TekVISA.** Uses TekVISA to communicate with test instrumentation through Ethernet (LAN connector on the side panel of the analyzer), and also to run a control program locally on the analyzer. Refer to *Using TekVISA* on page 1-8 for more information.

Ethernet Setup... Not available currently. Use the Windows XP Control Panel to set up networking parameters.

Setting Up the GPIB Port

When you use the GPIB port, follow these steps to set the parameters:

1. Press the **SYSTEM** key in the UTILITY block on the front panel.
2. Press the side key **Remote Setup... → GPIB Setup...**

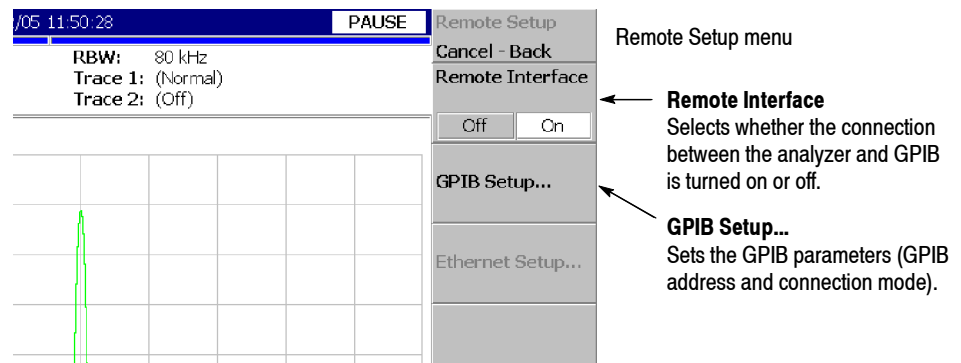

Figure 1-9: Setting the GPIB parameters

3. Press the **Connection Mode...** side key and select **GPIB Port**.
4. Press the **GPIB Address** side key and set the address using either the general purpose knob or the numeric keypad.

NOTE. The GPIB address cannot be initialized with *RST command.

5. Press the **Cancel-Back** (top) side key and then the **Remote Interface** side key to select **On**.

To disconnect the analyzer from the bus:

- Press the **Remote Interface** side key to select **Off**.

When the analyzer is disconnected from the bus, all the communication processes with the controller are interrupted.

Using TekVISA

TekVISA is Tektronix implementation of VISA (Virtual Instrument Software Architecture), an industry-standard communication protocol. It allows you to write programs using the RSA3400A Series SCPI command set to control the instrument through interfaces besides the built-in IEEE 488.2 port. Programs are written to execute on the local or remote controller. The RSA3400A Series implementation of TekVISA includes a subset of the TekVISA functionality offered on Tektronix oscilloscopes. The Virtual GPIB (GPIB8), GPIB, and LAN (VXI-11 protocol) interfaces are supported, but not the ASRL interface.

NOTE. *The details on TekVISA concepts and operations are explained in the TekVISA Programmer Manual. Refer to Installing TekVISA described below for accessing the files.*

Be aware of the following points:

- If TekVISA is not installed or has not been activated, and you select TekVISA as the connection mode, the instrument still attempts to connect to TekVISA. This does not hang up the instrument, but the GPIB port is taken off-line until you select GPIB Port as the connection mode again.
- Applications which are designed to execute locally on the instrument need to share the Windows processor with the measurement calculation software of the analyzer. If the controller application is very compute-intensive, it will slow down the analyzer application significantly.

Installing TekVISA

The TekVISA tools are not installed when you receive the instrument. Use the following procedure to install the tools.

To use TekVISA, these conditions must be satisfied:

- Windows XP is used as the instrument's operating system. Instruments using Windows 98SE must be upgraded to Windows XP for TekVISA to operate properly.
- A TekVISA-compatible version of the analyzer application is installed and running on the instrument. Version must be greater than 3.00.000.
- TekVISA is installed on the instrument. Version 2.03 is recommended.

The TekVISA-related files are on the internal hard disk of the analyzer in these directories:

- *C:\Tektronix\TekVISA\installer* contains the TekVISA installer.
- *C:\Tektronix\TekVISA>manual* contains the TekVISA Programmer Manual.

Use the following steps to install the TekVISA tools on your analyzer:

NOTE. For details on accessing Windows XP on the analyzer, refer to the RSA3408A User Manual.

1. Connect a USB mouse and keyboard to the USB ports on the side panel of the analyzer.
2. Display the Windows XP desktop on the screen.
3. Find the *setup.exe* file in the *C:\Tektronix\TekVISA\installer* directory using Windows Explorer or other file access methods.
4. Run *setup.exe* and follow the instructions.

The *TekVISA Programmer Manual* is found in the *C:\Tektronix\TekVISA>manual* directory.

Syntax and Commands

Command Syntax

This section contains information on the Standard Commands for Programmable Instruments (SCPI) and IEEE 488.2 Common Commands you can use to program your RSA3408A analyzer. The information is organized in the following subsections:

- Backus-Naur Form Definition
- SCPI Commands and Queries
- IEEE 488.2 Common Commands
- Constructed Mnemonics

Backus-Naur Form Definition

This manual may describe commands and queries using the Backus-Naur Form (BNF) notation. Table 2-1 defines the standard BNF symbols:

Table 2-1: BNF symbols and meanings

Symbol	Meaning
< >	Defined element
::=	Is defined as
	Exclusive OR
{ }	Group; one element is required
[]	Optional; can be omitted
. . .	Previous element(s) may be repeated
()	Comment

SCPI Commands and Queries

SCPI is a standard created by a consortium that provides guidelines for remote programming of instruments. These guidelines provide a consistent programming environment for instrument control and data transfer. This environment uses defined programming messages, instrument responses, and data format across all SCPI instruments, regardless of manufacturer. The analyzer uses a command language based on the SCPI standard.

The SCPI language is based on a hierarchical or tree structure (see Figure 2-1) that represents a subsystem. The top level of the tree is the root node; it is followed by one or more lower-level nodes.

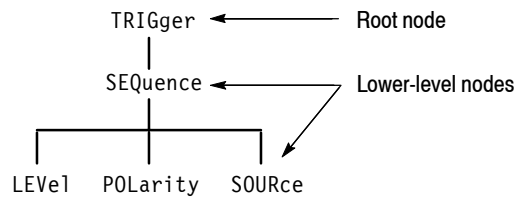

Figure 2- 1: Example of SCPI subsystem hierarchy tree

You can create commands and queries from these subsystem hierarchy trees. Commands specify actions for the instrument to perform. Queries return measurement data and information about parameter settings.

Creating Commands

SCPI commands are created by stringing together the nodes of a subsystem hierarchy and separating each node by a colon.

In Figure 2-1, TRIGger is the root node and SEQuence, LEVel, POLarity, and SOURce are lower-level nodes. To create a SCPI command, start with the root node TRIGger and move down the tree structure adding nodes until you reach the end of a branch. Most commands and some queries have parameters; you must include a value for these parameters. If you specify a parameter value that is out of range, the parameter will be set to a default value. The command descriptions, which start on page 2-79, list the valid values for all parameters.

For example, TRIGger:SEQuence:SOURce EXT is a valid SCPI command created from the hierarchy tree in Figure 2-1.

Creating Queries

To create a query, start at the root node of a tree structure, move down to the end of a branch, and add a question mark. TRIGger:SEQuence:SOURce? is an example of a valid SCPI query using the hierarchy tree in Figure 2-1.

Query Responses

The query causes the analyzer to return information about its status or settings. When a query is sent to the analyzer, only the values are returned. When the returned value is a mnemonic, it is noted in abbreviated format, as shown in Table 2-2.

Table 2-2: Query response examples

Query	Response
:DISPlay:OVlew:SGRam:X:SPAN?	10.0E+6
:SENSe:AVERage:TYPE?	RMS

A few queries also initiate an operation action before returning information. For example, the *CAL? query runs a calibration.

Parameter Types

Every parameter in the command and query descriptions is of a specified type. The parameters are enclosed in brackets, such as <value>. The parameter type is listed after the parameter and is enclosed in parentheses, for example, (discrete). Some parameter types are defined specifically for the RSA3000 Series command set and some are defined by ANSI/IEEE 488.2-1987 (refer to Table 2-3).

Table 2-3: Parameter types used in syntax descriptions

Parameter type	Description	Example
arbitrary block ¹	A specified length of arbitrary data	#512234xxxx . . . where 5 indicates that the following 5 digits (12234) specify the length of the data in bytes; xxxxx ... indicates the data
boolean	Boolean numbers or values	ON or 1; OFF or 0
discrete	A list of specific values	MIN, MAX, UP, DOWN
binary	Binary numbers	#B0110
octal	Octal numbers	#Q57, #Q3
hexadecimal ²	Hexadecimal numbers (0-9, A, B, C, D, E, F)	#HAA, #H1
NR1 ^{2,3} numeric	Integers	0, 1, 15, -1
NR2 ² numeric	Decimal numbers	1.2, 3.141516, -6.5
NR3 ² numeric	Floating point numbers	3.1415E-9, -16.1E5
NRf ² numeric	Flexible decimal number that may be type NR1, NR2 or NR3	See NR1, NR2, and NR3 examples
string ⁴	Alphanumeric characters (must be within quotation marks)	"Testing 1, 2, 3"

¹ Defined in ANSI/IEEE 488.2 as "Definite Length Arbitrary Block Response Data."

² An ANSI/IEEE 488.2-1992-defined parameter type.

³ Some commands and queries will accept an octal or hexadecimal value even though the parameter type is defined as NR1.

⁴ Defined in ANSI/IEEE 488.2 as "String Response Data."

SCPI-defined Parameters. In addition to the ANSI/IEEE 488.2-1987-defined parameters, RSA3000 Series support the following SCPI-defined parameters.

- <NRf> for boolean

OFF | ON | 0 | 1 | <NRf>

You can use <NRf> for boolean parameter. The values other than zero (OFF) are regarded as one (ON).

- MAXimum and MINimum for numeric parameters

You can use MAXimum and MINimum for the numeric parameter <NRf>. The following example sets the trigger level to the maximum (100%).

```
:TRIGger[:SEquence]:LEVel:IF MAXimum
```

The commands that have numeric parameters support the following query:

```
<header>? { MAXimum | MINimum }
```

The query command returns the maximum or minimum acceptable value for the command. For example,

```
:TRIGger[:SEquence]:LEVel:IF? MAXimum
```

returns 100 indicating the maximum trigger level is 100%.

- UP and DOWN for numeric parameters

The [:SENse]:FREQuency:CENTer command (refer to page 2-1073) supports UP and DOWN for the numeric parameters. The increment/decrement of UP/DOWN is determined by one of these commands:

```
[:SENse]:FREQuency:CENTer:STEP:AUTO  
[:SENse]:FREQuency:CENTer:STEP[:INCRement]
```

Special Characters

The Line Feed (LF) character (ASCII 10), and all characters in the range of ASCII 127-255 are defined as special characters. These characters are used in arbitrary block arguments only; using these characters in other parts of any command yields unpredictable results.

Abbreviating Commands, Queries, and Parameters

You can abbreviate most SCPI commands, queries, and parameters to an accepted short form. This manual shows these short forms as a combination of upper and lower case letters. The upper case letters indicate the accepted short form of a command. As shown in Figure 2-2, you can create a short form by using only the upper case letters. The accepted short form and the long form are equivalent and request the same action of the instrument.

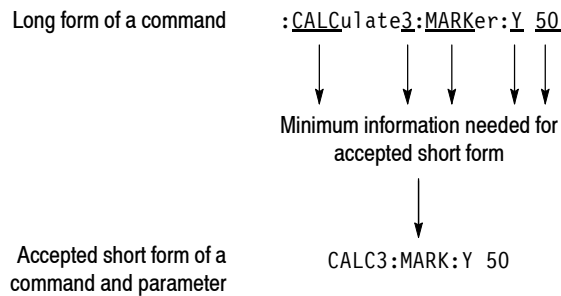

Figure 2-2: Example of abbreviating a command

NOTE. The numeric suffix of a command or query may be included in either the long form or short form; the analyzer will default to “1” if no suffix is used. In Figure 2-2, the “3” of “CALC3” indicates that the command is directed to View 3.

Chaining Commands and Queries

You can chain several commands or queries together into a single message. To create a chained message, first create a command or query, add a semicolon (;), and then add more commands or queries and semicolons until the message is complete. If the command following a semicolon is a root node, precede it with a colon (:). Figure 2-3 illustrates a chained message consisting of several commands and queries. The single chained message should end in a command or query, not a semicolon. Responses to any queries in your message are separated by semicolons.

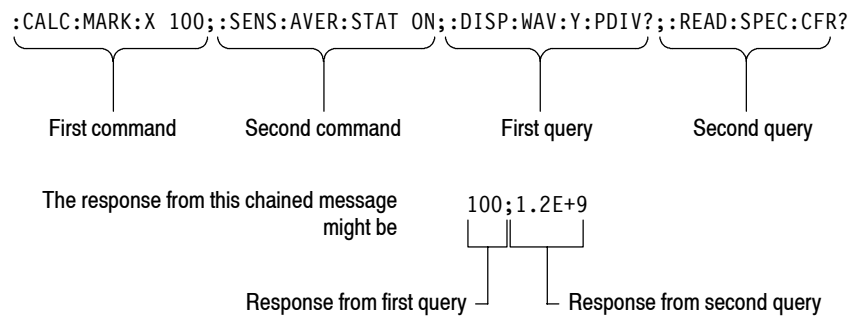

Figure 2-3: Example of chaining commands and queries

If a command or query has the same root and lower-level nodes as the previous command or query, you can omit these nodes. In Figure 2-4, the second command has the same root node (TRIG:SEQ:SEquence) as the first command, so these nodes can be omitted.

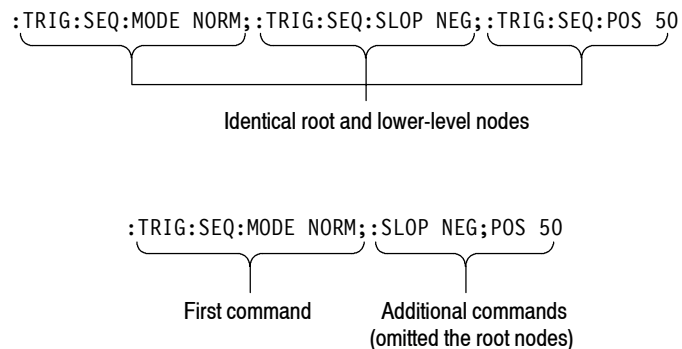

Figure 2-4: Example of omitting root and lower-level nodes in a chained message

Unit and SI Prefix

If the decimal numeric argument refers to amplitude, frequency, or time, you can express it using SI units instead of using the scaled explicit point input value format <NR3>. (SI units are units that conform to the Systeme International d'Unites standard.) For example, you can use the input format 200 mV or 1.0 MHz instead of 200.0E-3 or 1.0E+6, respectively, to specify voltage or frequency.

Table 2-4 lists the available units:

Table 2-4: Available units

Symbol	Meaning
dB	decibel (relative amplitude)
dBm	decibel (absolute amplitude)
DEG	degree (phase)
Hz	hertz (frequency)
PCT	percent (%)
s	second (time)
V	volt

The available SI prefixes are shown in Table 2-5 below:

Table 2-5: Available SI prefixes

SI prefix	A	F	P	N	U	M	K	MA ¹	G	T	PE	EX
Corresponding power	10 ⁻¹⁸	10 ⁻¹⁵	10 ⁻¹²	10 ⁻⁹	10 ⁻⁶	10 ⁻³	10 ⁺³	10 ⁺⁶	10 ⁺⁹	10 ⁺¹²	10 ⁺¹⁵	10 ⁺¹⁸

¹ When the unit is “Hz”, “M” may be used instead of “MA” so that the frequency can be represented by “MHz”.

You can omit a unit in a command, but you must include the unit when using a SI prefix. For example, frequency of 15 MHz can be described as follows:

15.0E6, 1.5E7Hz, 15000000, 15000000Hz, 15MHz, etc.
 (“15M” is not allowed.)

Note that you can use either lower or upper case units and prefixes. The following examples have the same result, respectively.

170mhz, 170mHz, 170MHz, etc.
 250mv, 250mV, 250MV, etc.

General Rules

Here are three general rules for using SCPI commands, queries, and parameters:

- You can use single (‘ ’) or double (“ ”) quotation marks for quoted strings, but you cannot use both types of quotation marks for the same string.
correct: "This string uses quotation marks correctly."
correct: `This string also uses quotation marks correctly.`
incorrect: "This string does not use quotation marks correctly.`
- You can use upper case, lower case, or a mixture of both cases for all commands, queries, and parameters.

SENSE:SPECTRUM:FFT:LENGTH 1024

is the same as

sense:spectrum:fft:length 1024

and

SENSE:spectrum:FFT:length 1024

NOTE. *Literal strings (quoted) are case sensitive. For example: file names.*

- No embedded spaces are allowed between or within nodes.

correct: SENSE:SPECTRUM:FFT:LENGTH 1024

incorrect: SENSE: SPECTRUM: FFT: LEN GTH 1024

IEEE 488.2 Common Commands

Description ANSI/IEEE Standard 488.2 defines the codes, formats, protocols, and usage of common commands and queries used on the interface between the controller and the instruments. The analyzer complies with this standard.

Command and Query Structure The syntax for an IEEE 488.2 common command is an asterisk (*) followed by a command and, optionally, a space and parameter value. The syntax for an IEEE 488.2 common query is an asterisk (*) followed by a query and a question mark. All of the common commands and queries are listed in the last part of the *Syntax and Commands* section. The following are examples of common commands:

- *ESE 16
- *CLS

The following are examples of common queries:

- *ESR?
- *IDN?

Constructed Mnemonics

Some header mnemonics specify one of a range of mnemonics. For example, a channel mnemonic can be either CALCulate1, CALCulate2, CALCulate3, or CALCulate4. You use these mnemonics in the command just as you do any other mnemonic. For example, there is a :CALCulate1:MARKer:MODE command, and there is also a :CALCulate2:MARKer:MODE command. In the command descriptions, this list of choices is abbreviated as CALCulate<x>. The value of <x> is the upper range of valid suffixes. If the numeric suffix is omitted, the analyzer uses the default value of “1”.

Table 2-6: Constructed mnemonics

Symbol	Meaning
CALCulate<x>	A view specifier where <x> = 1 to 4.
DLINe<x>	A horizontal display line specifier where <x> = 1 or 2.
VLINe<x>	A vertical display line specifier where <x> = 1 or 2.
MARKer<x>	A marker specifier where <x> = 1 or 2.
TRACe<x> DATA<x>	A trace specifier where <x> = 1 or 2.

Command Groups

This section lists the RSA3000 Series analyzer commands in two ways. It first presents them by functional groups. It then lists them alphabetically. The functional group list starts below. The alphabetical list provides more detail on each command and starts on page 2-79.

The RSA3000 Series analyzers conform to the Standard Commands for Programmable Instruments (SCPI) 1999.0 and IEEE Std 488.2-1987 except where noted.

Items followed by question marks are queries; items without question marks are commands. Some items in this section have a question mark in parentheses (?) in the command header section; this indicates that the item can be both a command and a query.

For the conventions of notation in this manual, refer to *Command Syntax* on page 2-1 and following pages.

Measurement Mode

Each command may be available or unavailable, depending on the current measurement mode. The “Measurement Modes” item in each command description shows the measurement mode in which the command is available. To set the measurement mode, use the :INSTrument[:SElect] command (refer to page 2-884) using one of the mnemonics listed below:

Table 2-7: Measurement mode

Mnemonic	Meaning
S/A mode	
SANORMAL	Normal spectrum analysis
SASGRAM	Spectrum analysis with spectrogram
SARTIME	Real-time spectrum analysis
SAZRTIME	Real-time spectrum analysis with zoom function
SAUL3G	W-CDMA uplink spectrum analysis (Option 23 only)
SADLR5_3G	3GPP-R5 downlink spectrum analysis (Option 27 only)
SAULR5_3G	3GPP-R5 uplink spectrum analysis (Option 27 only)

Table 2-7: Measurement mode (Cont.)

Mnemonic	Meaning
Demod mode	
DEMADEM	Analog modulation analysis
DEMDEM	Digital modulation analysis (Option 21 only)
DEMRFD	RFID analysis (Option 21 only)
DEMUL3G	W-CDMA uplink modulation analysis (Option 23 only)
DEMGSMEDGE	GSM/EDGE modulation analysis (Option 24 only)
DEMFLCDMA2K	cdma2000 forward link analysis (Option 25 only)
DEMRLCDMA2K	cdma2000 reverse link analysis (Option 25 only)
DEMFL1XEVD0	cdma2000 1xEV-DO forward link analysis (Option 26 only)
DEMRL1XEVD0	cdma2000 1xEV-DO reverse link analysis (Option 26 only)
DEMDLR5_3G	3GPP-R5 downlink modulation analysis (Option 27 only)
DEMULR5_3G	3GPP-R5 uplink modulation analysis (Option 27 only)
DEMTD_SCDMA	TD-SCDMA modulation analysis (Option 28 only)
DEM WLAN	IEEE802.11a/b/g analysis (Option 29 only)
DEMSWLAN	IEEE802.11n (nx1) analysis (Option 29 only)
DEMM2WLAN	IEEE802.11n MIMO (2x2) analysis (Option 29 only)
DEMDLR6_3G	3GPP-R6 downlink modulation analysis (Option 40 only)
DEMULR6_3G	3GPP-R6 uplink modulation analysis (Option 40 only)
Time mode	
TIMCCDF	CCDF analysis
TIMTRAN	Time characteristics analysis
TIMPULSE	Pulse characteristics analysis
TIMSSOURCE	Signal source analysis (Option 21 only)

Functional Groups

The commands are divided into the groups listed below.

Table 2-8: List of command groups

Command group	Function
IEEE common	Conforms to the IEEE Std 488.2-1987.
:ABORt	Resets and restarts sweep, measurement, and trigger.
:CALCulate	Controls the markers and the display line.
:CALibration	Calibrates the analyzer.
:CONFigure	Configures the analyzer for each measurement session.
:DISPlay	Controls how to show waveform and measurement result on screen.
:FETCh	Retrieves the measurements from the last data acquired.
:FORMat	Sets the output data format.
:HCOPy	Controls screen hardcopy.
:INITiate	Controls data acquisition.
:INPut	Sets the input-related conditions.
:INSTrument	Selects a measurement mode.
:MMEMory	Controls file saving/loading to/from the hard disk or floppy disk.
:OUTPut	Controls the characteristics of the analyzer's output port.
:PROGram	Controls macro programs.
:READ	Acquires data and obtain the measurement results.
:SENSe	Sets up detailed conditions for each measurement.
:STATus	Controls the status and event registers.
:SYSTem	Sets the system parameters and queries system information.
:TRACe	Controls display of Trace 1 and 2.
:TRIGger	Controls triggering.
:UNIT	Specifies fundamental units for measurement.

The following sections list the commands by group.

IEEE Common Commands

The IEEE 488.2 common commands have a “*” prefix.

Table 2-9: IEEE common commands

Header	Description
*CAL?	Runs all the calibration routines.
*CLS	Clears the status or event.
*ESE(?)	Sets the value for the ESER register.
*ESR?	Queries the SESR register value.
*IDN?	Queries the analyzer ID.
*OPC(?)	Synchronizes commands.
*OPT?	Queries the options incorporated in the analyzer.
*RST	Restores the factory initialization settings.
*SRE(?)	Sets the value for the SRER register.
*STB?	Queries the Status Byte Register value.
*TRG	Generates a trigger event.
*TST?	Runs a self test.
*WAI	Waits until another command has run.

:ABORt Commands

Resets the trigger system and related actions such as data acquisition and measurement.

Table 2-10: :ABORt commands

Header	Description
:ABORt	Resets and restarts sweep, trigger, and measurement.

:CALCulate Commands

Control the marker and the display line.

Table 2- 11: :CALCulate commands

Header	Description
:CALCulate<x>:DLINe<y>(?)	Sets the vertical position of the horizontal line.
:CALCulate<x>:DLINe<y>:STATe(?)	Determines whether to show the horizontal line.
:CALCulate<x>:MARKer:AOFF	Turns off all the markers.
:CALCulate<x>:MARKer<y>:MAXimum	Places the marker at the maximum point on the trace.
:CALCulate<x>:MARKer<y>:MODE(?)	Selects the marker mode (position or delta).
:CALCulate<x>:MARKer<y>:PEAK:HIGHer	Moves the marker to the next higher peak.
:CALCulate<x>:MARKer<y>:PEAK:LEFT	Moves the marker to the peak on the left.
:CALCulate<x>:MARKer<y>:PEAK:LOWer	Moves the marker to the next lower peak.
:CALCulate<x>:MARKer<y>:PEAK:RIGHT	Moves the marker to the peak on the right.
:CALCulate<x>:MARKer<y>:PTHReshold(?)	Sets the minimum jump of the marker on the horizontal axis.
:CALCulate<x>:MARKer<y>:ROFF	Turn off the reference cursor.
:CALCulate<x>:MARKer<y>[:SET]:CENTer	Sets the center frequency to the value at the marker position.
:CALCulate<x>:MARKer<y>[:SET]:MEASurement	Sets the measurement position with the marker.
:CALCulate<x>:MARKer<y>[:SET]:RCURsor	Displays the reference cursor at the marker position.
:CALCulate<x>:MARKer<y>[:STATe]	Determines whether to show the marker.
:CALCulate<x>:MARKer<y>:T(?)	Positions the marker on the time axis.
:CALCulate<x>:MARKer<y>:TOGGle	Replaces the delta marker with the main marker.
:CALCulate<x>:MARKer<y>:TRACe(?)	Selects the trace to place the marker.
:CALCulate<x>:MARKer<y>:X(?)	Positions the marker on the horizontal axis.
:CALCulate<x>:MARKer<y>:Y(?)	Positions the marker on the vertical axis.
:CALCulate<x>:VLINe<y>(?)	Sets the horizontal position of the vertical line.
:CALCulate<x>:VLINe<y>:STATe(?)	Determines whether to show the vertical line.

:CALibration Commands

Calibrate the analyzer.

Table 2-12: :CALibration commands

Header	Description
:CALibration[:ALL](?)	Runs all the calibration routines.
:CALibration:AUTO(?)	Determines whether to run the RF gain calibration automatically.
:CALibration:DATA:DEFault	Restores the calibrated data to the factory defaults.
:CALibration:FLATness:IF(?)	Runs the IF flatness calibration.
:CALibration:IQ:CORRection:MAGNitude?	Returns the magnitude values of the IF flatness correction factor.
:CALibration:IQ:CORRection:PHASe?	Returns the phase values of the IF flatness correction factor.
:CALibration:IQ:HEADer?	Returns the header of an IQ data file.
:CALibration:IQ:VFRAme:BNUMber(?)	Specifies the block number.
:CALibration:IQ:VFRAme:TYPE](?)	Selects the type of valid frame of IQ data.
:CALibration:OFFSet:BASEbanddc(?)	Runs the baseband DC offset calibration.
:CALibration:OFFSet:CENTer(?)	Runs the center offset calibration.
:CALibration:OFFSet:IQINput(?) (Option 03 only)	Runs the IQ input offset calibration.
:CALibration:RF(?)	Runs the RF gain calibration.

:CONFigure Commands

Set up the analyzer in order to perform the specified measurement.

Table 2-13: :CONFigure commands

Header	Description
:CONFigure:ADEMod:AM	Sets the analyzer to the AM signal analysis default settings.
:CONFigure:ADEMod:FM	Sets the analyzer to the FM signal analysis default settings.
:CONFigure:ADEMod:PM	Sets the analyzer to the PM signal analysis default settings.
:CONFigure:ADEMod:PSPectrum	Sets the analyzer to the pulse spectrum measurement default settings.
:CONFigure:CCDF	Sets the analyzer to the CCDF measurement default settings.
:CONFigure:OVlew	Turns off measurement to obtain display data in the overview.
:CONFigure:PULSe	Sets the analyzer to the pulse characteristics measurement default settings.

Table 2-13: :CONFigure commands (Cont.)

Header	Description
:CONFigure:SPEctrum	Sets the analyzer to the spectrum measurement default settings.
:CONFigure:SPEctrum:ACPower	Sets the analyzer to the ACPR measurement default settings.
:CONFigure:SPEctrum:CFrequency	Sets the analyzer to the carrier frequency measurement default settings.
:CONFigure:SPEctrum:CHPower	Sets the analyzer to the channel power measurement default settings.
:CONFigure:SPEctrum:CNRatio	Sets the analyzer to the C/N measurement default settings.
:CONFigure:SPEctrum:EBWidth	Sets the analyzer to the emission bandwidth measurement default settings.
:CONFigure:SPEctrum:OBWidth	Sets the analyzer to the OBW measurement default settings.
:CONFigure:SPEctrum:SPURious	Sets the analyzer to the spurious signal measurement default settings.
:CONFigure:TFRrequency:RTIME	Sets the analyzer to the real-time spectrum measurement default settings.
:CONFigure:TFRrequency:SGRam	Sets the analyzer to the spectrogram measurement default settings.
:CONFigure:TRANSient:FVTime	Sets the analyzer to the frequency versus time measurement default settings.
:CONFigure:TRANSient:IQVTime	Sets the analyzer to the IQ level versus time measurement default settings.
:CONFigure:TRANSient:PVTime	Sets the analyzer to the power versus time measurement default settings.

:CONFigure Commands (Option)

Table 2-14 shows the :CONFigure commands for optional analysis software.

Table 2-14: :CONFigure commands (Option)

Header	Description
Option 21 Advanced measurement suite related	
:CONFigure:DDEMod	Sets the analyzer to the digital modulation analysis default settings.
:CONFigure:RFID	Sets the analyzer to the RFID analysis default settings.
:CONFigure:SSource	Sets the analyzer to the signal source analysis default settings.
Option 23 W-CDMA uplink analysis related	
:CONFigure:AC3Gpp	Sets the analyzer to the W-CDMA ACLR measurement default settings.
:CONFigure:UL3Gpp	Sets the analyzer to the W-CDMA uplink analysis default settings.
Option 24 W-GSM/EDGE analysis related	
:CONFigure:GSMedge:MACCuracy	Sets the analyzer to the modulation accuracy measurement default settings.
:CONFigure:GSMedge:MCPower	Sets the analyzer to the mean carrier power measurement default settings.
:CONFigure:GSMedge:MODulation	Sets the analyzer to the modulation spectrum measurement default settings.
:CONFigure:GSMedge:PVTime	Sets the analyzer to the power versus time measurement default settings.
:CONFigure:GSMedge:SPURious	Sets the analyzer to the spurious measurement default settings.
:CONFigure:GSMedge:SWITching	Sets the analyzer to the switching spectrum measurement default settings.

Table 2- 14: :CONFigure commands (Option) (Cont.)

Header	Description
Option 25 cdma2000 analysis related (:Standard = :FLCDMA2K :RLCDMA2K)	
:CONFigure:Standard:ACPower	Sets the analyzer to the ACPR measurement default settings.
:CONFigure:Standard:CCDF	Sets the analyzer to the CCDF measurement default settings.
:CONFigure:Standard:CDPower	Sets the analyzer to the code domain power measurement default settings.
:CONFigure:Standard:CHPower	Sets the analyzer to the channel power measurement default settings.
:CONFigure:Standard:IM	Sets the analyzer to the intermodulation measurement default settings.
:CONFigure:Standard:MACCuracy	Sets the analyzer to the modulation accuracy measurement default settings.
:CONFigure:Standard:OBWidth	Sets the analyzer to the occupied bandwidth measurement default settings.
:CONFigure:Standard:PCCHannel	Sets the analyzer to the pilot to code channel measurement default settings.
:CONFigure:RLCDMA2K:PVTime	Sets the analyzer to the gated output power measurement default settings.
:CONFigure:Standard:SEMask	Sets the analyzer to the spectrum emission mask test default settings.
Option 26 1xEV-DO analysis related (:Standard = :FL1XEVD0 :RL1XEVD0)	
:CONFigure:Standard:ACPower	Sets the analyzer to the ACPR measurement default settings.
:CONFigure:Standard:CCDF	Sets the analyzer to the CCDF measurement default settings.
:CONFigure:Standard:CDPower	Sets the analyzer to the code domain power measurement default settings.
:CONFigure:Standard:CHPower	Sets the analyzer to the channel power measurement default settings.
:CONFigure:Standard:IM	Sets the analyzer to the intermodulation measurement default settings.
:CONFigure:Standard:MACCuracy	Sets the analyzer to the modulation accuracy measurement default settings.
:CONFigure:Standard:OBWidth	Sets the analyzer to the occupied bandwidth measurement default settings.
:CONFigure:Standard:PCCHannel	Sets the analyzer to the pilot to code channel measurement default settings.
:CONFigure:FL1XEVD0:PVTime	Sets the analyzer to the gated output power measurement default settings.
:CONFigure:Standard:SEMask	Sets the analyzer to the spectrum emission mask test default settings.
Option 27 3GPP-R5 analysis related (:Standard = :SADLR5_3GPP :SAULR5_3GPP)	
:CONFigure:DLR5_3GPP	Sets the analyzer for the modulation analysis in 3GPP-R5 downlink.
:CONFigure:Standard:ACLR	Sets the analyzer to the ACLR measurement default settings.
:CONFigure:Standard:CFrequency	Sets the analyzer to the carrier frequency measurement default settings.
:CONFigure:Standard:CHPower	Sets the analyzer to the channel power measurement default settings.
:CONFigure:Standard:EBWidth	Sets the analyzer to the EBW measurement default settings.
:CONFigure:SADLR5_3GPP:MCAClr	Sets the analyzer to the multi-carrier ACLR measurement default settings.
:CONFigure:Standard:OBWidth	Sets the analyzer to the OBW measurement default settings.
:CONFigure:Standard:SEMask	Sets the analyzer to the spectrum emission mask test default settings.
:CONFigure:ULR5_3GPP	Sets the analyzer for the modulation analysis in 3GPP-R5 uplink.

Table 2-14: :CONFigure commands (Option) (Cont.)

Header	Description
Option 28 TD-SCDMA analysis related	
:CONFigure:TD_SCDMA:ACLR	Sets the analyzer to the adjacent channel leakage power ratio default settings.
:CONFigure:TD_SCDMA:CDPower	Sets the analyzer to the code domain power measurement default settings.
:CONFigure:TD_SCDMA:CHPower	Sets the analyzer to the channel power measurement default settings.
:CONFigure:TD_SCDMA:IM	Sets the analyzer to the intermodulation measurement default settings.
:CONFigure:TD_SCDMA:MACCuracy	Sets the analyzer to the modulation accuracy measurement default settings.
:CONFigure:TD_SCDMA:OBWidth	Sets the analyzer to the occupied bandwidth measurement default settings.
:CONFigure:TD_SCDMA:SEMask	Sets the analyzer to the spectrum emission mask measurement default settings.
:CONFigure:TD_SCDMA:SFSummary	Sets the analyzer to the subframe summary measurement default settings.
:CONFigure:TD_SCDMA:STABLE	Sets the analyzer to the symbol table default settings.
:CONFigure:TD_SCDMA:TOOMask	Sets the analyzer to the transmit on/off mask measurement default settings.
:CONFigure:TD_SCDMA:TSSummary	Sets the analyzer to the timeslot summary measurement default settings.
Option 29 WLAN analysis related	
:CONFigure:M2WLAN	Sets the analyzer for 802.11n MIMO (2x2) modulation analysis.
:CONFigure:SWLAN	Sets the analyzer for 802.11n (nx1) modulation analysis.
:CONFigure:SWLAN:SMASK	Sets the analyzer to 802.11n spectrum mask measurement default settings.
:CONFigure:WLAN	Sets the analyzer for 802.11a/b/g modulation analysis.
:CONFigure:WLAN:SMASK	Sets the analyzer to 802.11a/b/g spectrum mask measurement default settings.
:CONFigure:WLAN:TPOWer	Sets the analyzer to 802.11a/b/g transmit power measurement default settings.
Option 40 3GPP-R6 analysis related	
:CONFigure:DLR6_3GPP	Sets the analyzer for the modulation analysis in 3GPP-R6 downlink.
:CONFigure:ULR6_3GPP	Sets the analyzer for the modulation analysis in 3GPP-R6 uplink.

:DISPlay Commands

Control how to show measurement data on the screen.

Table 2-15: :DISPlay commands

Header	Description
:DISPlay:CCDF subgroup	CCDF measurement related.
:DISPlay:CCDF:LINE:GAUSSian[:STATE](?)	Determines whether to show the Gaussian line.
:DISPlay:CCDF:LINE:REFerence[:STATE](?)	Determines whether to show the reference line.
:DISPlay:CCDF:LINE:REFerence:STORe	Stores the current CCDF trace as the reference line.

Table 2- 15: :DISPlay commands (Cont.)

Header	Description
:DISPlay:CCDF:X[:SCALe]:AUTO(?)	Determines whether to set the horizontal scale automatically.
:DISPlay:CCDF:X[:SCALe]:MAXimum(?)	Sets the maximum horizontal value (right edge).
:DISPlay:CCDF:X[:SCALe]:OFFSet(?)	Sets the minimum horizontal value (left edge).
:DISPlay:CCDF:Y[:SCALe]:FIT	Runs auto-scale.
:DISPlay:CCDF:Y[:SCALe]:FULL	Sets the vertical axis to the default full-scale value.
:DISPlay:CCDF:Y[:SCALe]:MAXimum(?)	Sets the maximum vertical value (top).
:DISPlay:CCDF:Y[:SCALe]:MINimum(?)	Sets the minimum vertical value (bottom).
:DISPlay:OView subgroup	DEMOM and TIME mode overview related.
:DISPlay:OView:FORMat(?)	Selects the overview display format.
:DISPlay:OView:OTINdicator(?)	Determines whether to show the trigger output indicator.
:DISPlay:OView:SGRam:COLor[:SCALe]:OFFSet(?)	Sets the minimum color-axis value (bottom) of the spectrogram.
:DISPlay:OView:SGRam:COLor[:SCALe]:RANGe(?)	Sets the color-axis full-scale of the spectrogram.
:DISPlay:OView:SGRam:X[:SCALe]:OFFSet(?)	Sets the minimum horizontal value (left edge) of the spectrogram.
:DISPlay:OView:SGRam:X[:SCALe]:SPAN(?)	Sets the horizontal full-scale (span) of the spectrogram.
:DISPlay:OView:SGRam:Y[:SCALe]:OFFSet(?)	Sets the minimum vertical value (bottom) of the spectrogram.
:DISPlay:OView:SGRam:Y[:SCALe]:PLINe(?)	Sets the vertical scale of the spectrogram.
:DISPlay:OView:WAVEform:X[:SCALe]:OFFSet(?)	Sets the minimum horizontal value (left edge) in the time domain display.
:DISPlay:OView:WAVEform:X[:SCALe]:PDIVision(?)	Sets the horizontal scale in the time domain display.
:DISPlay:OView:WAVEform:Y[:SCALe]:FIT	Runs auto-scale on the time domain display.
:DISPlay:OView:WAVEform:Y[:SCALe]:FULL	Sets the vertical axis to the default full-scale value.
:DISPlay:OView:WAVEform:Y[:SCALe]:OFFSet(?)	Sets the minimum vertical value in the time domain display.
:DISPlay:OView:WAVEform:Y[:SCALe]:PDIVision(?)	Sets the vertical scale in the time domain display.
:DISPlay:OView:ZOOM:COLor[:SCALe]:OFFSet(?)	Sets the minimum color-axis value of the spectrogram with zoom.
:DISPlay:OView:ZOOM:COLor[:SCALe]:RANGe(?)	Sets the color-axis full-scale of the spectrogram with zoom.
:DISPlay:OView:ZOOM:X[:SCALe]:OFFSet(?)	Sets the minimum horizontal value of the spectrogram with zoom.
:DISPlay:OView:ZOOM:X[:SCALe]:SPAN(?)	Sets the horizontal full-scale of the spectrogram with zoom.
:DISPlay:OView:ZOOM:Y[:SCALe]:OFFSet(?)	Sets the minimum vertical value of the spectrogram with zoom.
:DISPlay:OView:ZOOM:Y[:SCALe]:PLINe(?)	Sets the vertical scale of the spectrogram with zoom.
:DISPlay:PULSe:MView SVIew subgroup	The main view and subview related in the pulse measurements
:DISPlay:PULSe:MView:RESult:CHPower(?)	Determines whether to show channel power measurement results.
:DISPlay:PULSe:MView:RESult:DCYClE(?)	Determines whether to show duty cycle measurement results.
:DISPlay:PULSe:MView:RESult:EBWidth(?)	Determines whether to show EBW measurement results.
:DISPlay:PULSe:MView:RESult:FREQuency(?)	Determines whether to show carrier frequency measurement results.
:DISPlay:PULSe:MView:RESult:OBWidth(?)	Determines whether to show OBW measurement results.
:DISPlay:PULSe:MView:RESult:OORatio(?)	Determines whether to show on/off-ratio measurement results.

Table 2-15: :DISPlay commands (Cont.)

Header	Description
:DISPlay:PULSe:MVlew:RESult:PERiod(?)	Determines whether to show repetition interval measurement results.
:DISPlay:PULSe:MVlew:RESult:PHASe(?)	Determines whether to show pulse-pulse phase measurement results.
:DISPlay:PULSe:MVlew:RESult:PPOWer(?)	Determines whether to show peak power measurement results.
:DISPlay:PULSe:MVlew:RESult:RIPPLe(?)	Determines whether to show pulse ripple measurement results.
:DISPlay:PULSe:MVlew:RESult:WIDTh(?)	Determines whether to show pulse width measurement results.
:DISPlay:PULSe:SVlew:FORMat(?)	Selects the display format of the subview.
:DISPlay:PULSe:SVlew:GUIDelines(?)	Determines whether to show the guidelines in the subview.
:DISPlay:PULSe:SVlew:RANGe(?)	Selects how to set the horizontal scale in the subview.
:DISPlay:PULSe:SVlew:RESult(?)	Selects how to show the result graph in the subview.
:DISPlay:PULSe:SVlew:SELEct(?)	Selects a pulse to measure.
:DISPlay:PULSe:SPEctrum subgroup	The spectrum view related in the pulse measurements
:DISPlay:PULSe:SPEctrum:X[:SCALe]:OFFSet(?)	Sets the minimum horizontal value (left edge).
:DISPlay:PULSe:SPEctrum:X[:SCALe]:PDIVision(?)	Sets the horizontal scale (per division).
:DISPlay:PULSe:SPEctrum:Y[:SCALe]:FIT	Runs the auto-scale.
:DISPlay:PULSe:SPEctrum:Y[:SCALe]:FULL	Sets the vertical axis to the default full-scale value.
:DISPlay:PULSe:SPEctrum:Y[:SCALe]:OFFSet(?)	Sets the minimum vertical value (bottom).
:DISPlay:PULSe:SPEctrum:Y[:SCALe]:PDIVision(?)	Sets the vertical scale (per division).
:DISPlay:PULSe:WAVEform subgroup	Time domain display related in the pulse measurements
:DISPlay:PULSe:WAVEform:X[:SCALe]:OFFSet(?)	Sets the minimum value of the horizontal axis (left edge).
:DISPlay:PULSe:WAVEform:X[:SCALe]:PDIVision(?)	Sets or queries the horizontal scale (per division).
:DISPlay:PULSe:WAVEform:Y[:SCALe]:FIT	Runs the auto-scale.
:DISPlay:PULSe:WAVEform:Y[:SCALe]:FULL	Sets the vertical axis to the default full-scale value.
:DISPlay:PULSe:WAVEform:Y[:SCALe]:OFFSet(?)	Sets the minimum value (bottom) of the vertical axis.
:DISPlay:PULSe:WAVEform:Y[:SCALe]:PDIVision(?)	Sets the vertical scale (per division).
:DISPlay:SPEctrum subgroup	Spectrum view related.
:DISPlay:SPEctrum:BMARker:STATe(?)	Turns on or off the band power marker.
:DISPlay:SPEctrum:GRATICule:GRID(?)	Determines how the graticule is displayed.
:DISPlay:SPEctrum:MLINe:AMPLitude:INTerval(?)	Sets the interval of the amplitude multi display lines.
:DISPlay:SPEctrum:MLINe:AMPLitude:OFFSet(?)	Sets the offset of the amplitude multi display lines.
:DISPlay:SPEctrum:MLINe:AMPLitude[:STATe](?)	Determines whether to show the amplitude multi display lines.
:DISPlay:SPEctrum:MLINe:ANNotation[:STATe](?)	Determines whether to show the readout of the multi display lines.
:DISPlay:SPEctrum:MLINe:FREQUency:INTerval(?)	Sets the interval of the frequency multi display lines.
:DISPlay:SPEctrum:MLINe:FREQUency:OFFSet(?)	Sets the offset of the frequency multi display line.
:DISPlay:SPEctrum:MLINe:FREQUency[:STATe](?)	Determines whether to show the frequency multi display lines.

Table 2- 15: :DISPlay commands (Cont.)

Header	Description
:DISPlay:SPEctrum:X[:SCALe]:OFFSet(?)	Sets the minimum horizontal value (start frequency).
:DISPlay:SPEctrum:X[:SCALe]:PDIVision(?)	Sets the horizontal scale (span/div).
:DISPlay:SPEctrum:Y[:SCALe]:FIT	Runs auto-scale.
:DISPlay:SPEctrum:Y[:SCALe]:FULL	Sets the vertical axis to the default full-scale value.
:DISPlay:SPEctrum:Y[:SCALe]:OFFSet(?)	Sets the minimum vertical, or amplitude, value (bottom).
:DISPlay:SPEctrum:Y[:SCALe]:PDIVision(?)	Sets the vertical, or amplitude, scale per division.
:DISPlay:TFRequency subgroup	3-dimensional view (spectrogram) related.
:DISPlay:TFRequency:SGRam:COLor[:SCALe]:OFFSet(?)	Sets the minimum color-axis value (bottom) of the spectrogram.
:DISPlay:TFRequency:SGRam:COLor[:SCALe]:RANGe(?)	Sets the scale of the spectrogram's color axis.
:DISPlay:TFRequency:SGRam:MLINe:ANNotation[:STATe](?)	Determines whether to show the readout of the multi display lines.
:DISPlay:TFRequency:SGRam:MLINe:FRequency:INteRval(?)	Sets the interval of the frequency multi display lines.
:DISPlay:TFRequency:SGRam:MLINe:FRequency:OFFSet(?)	Sets the offset of the frequency multi display lines.
:DISPlay:TFRequency:SGRam:MLINe:FRequency[:STATe](?)	Determines whether to show the frequency multi display lines.
:DISPlay:TFRequency:SGRam:MLINe:TiME:INteRval(?)	Sets the interval of the time multi display lines.
:DISPlay:TFRequency:SGRam:MLINe:TiME:OFFSet(?)	Sets the offset of the time multi display lines.
:DISPlay:TFRequency:SGRam:MLINe:TiME[:STATe](?)	Determines whether to show the time multi display lines.
:DISPlay:TFRequency:SGRam:X[:SCALe]:OFFSet(?)	Sets the minimum horizontal value (left edge) of the spectrogram.
:DISPlay:TFRequency:SGRam:X[:SCALe]:SPAN(?)	Sets the horizontal full-scale (span) of the spectrogram.
:DISPlay:TFRequency:SGRam:Y[:SCALe]:OFFSet(?)	Sets the minimum vertical value (bottom) of the spectrogram.
:DISPlay:TFRequency:SGRam:Y[:SCALe]:PLINe(?)	Sets the vertical scale of the spectrogram.
:DISPlay[:VIEW] subgroup	General conditions about display.
:DISPlay[:VIEW]:BRIGhtness(?)	Sets the display brightness.
:DISPlay[:VIEW]:FORMat(?)	Selects the view display format.
:DISPlay:WAVeform subgroup	Time domain display related.
:DISPlay:WAVeform:X[:SCALe]:OFFSet(?)	Sets the minimum horizontal, or time, value (left edge).
:DISPlay:WAVeform:X[:SCALe]:PDIVision(?)	Sets the horizontal, or time, scale per division.
:DISPlay:WAVeform:Y[:SCALe]:FIT	Runs auto-scale.
:DISPlay:WAVeform:Y[:SCALe]:FULL	Sets the vertical axis to the default full-scale value.
:DISPlay:WAVeform:Y[:SCALe]:OFFSet(?)	Sets the minimum vertical, or amplitude, value (bottom).
:DISPlay:WAVeform:Y[:SCALe]:PDIVision(?)	Sets the vertical, or amplitude, scale.

:DISPlay Commands (Option)

Table 2-16 shows the :DISPlay commands for optional analysis software.

Table 2-16: :DISPlay commands (Option)

Header	Description
Option 21 Advanced measurement suite related	
:DISPlay:DDEMod subgroup	Digital modulation analysis related.
:DISPlay:DDEMod:CCDF:LINE:GAUSSian[:STATe](?)	Determines whether to display the Gaussian line.
:DISPlay:DDEMod:MView:DSTart(?)	Selects the decoding start position for ASK, FSK, and GFSK signals.
:DISPlay:DDEMod:MView:FORMat(?)	Selects the main view display format.
:DISPlay:DDEMod:MView:HSSHift(?)	Selects the Q data half symbol shift for an OQPSK signal.
:DISPlay:DDEMod:MView:RADix(?)	Selects the base of symbols in the main view.
:DISPlay:DDEMod:MView:X[:SCALE]:OFFSet(?)	Sets the minimum horizontal value (left edge) in the main view.
:DISPlay:DDEMod:MView:X[:SCALE]:RANGe(?)	Sets the horizontal full-scale in the main view.
:DISPlay:DDEMod:MView:Y[:SCALE]:FIT	Runs auto-scale on the main view.
:DISPlay:DDEMod:MView:Y[:SCALE]:FULL	Sets the main view's vertical axis to the default full-scale value.
:DISPlay:DDEMod:MView:Y[:SCALE]:MAXimum(?)	Sets the maximum vertical value (top end) in the CCDF main view.
:DISPlay:DDEMod:MView:Y[:SCALE]:MINimum(?)	Sets the minimum vertical value (top end) in the CCDF main view.
:DISPlay:DDEMod:MView:Y[:SCALE]:OFFSet(?)	Sets the minimum vertical value (bottom) in the main view.
:DISPlay:DDEMod:MView:Y[:SCALE]:RANGe(?)	Sets the vertical full-scale in the main view.
:DISPlay:DDEMod:NLINEarity:LINE:BFIT[:STATe](?)	Determines whether to display the best-fit line.
:DISPlay:DDEMod:NLINEarity:LINE:REFerence[:STATe](?)	Determines whether to display the recovered reference line.
:DISPlay:DDEMod:NLINEarity:MASK[:STATe](?)	Determines whether the linear signal region is visible.
:DISPlay:DDEMod:SVIew:DSTart(?)	Selects the decoding start position for ASK, FSK, and GFSK signals.
:DISPlay:DDEMod:SVIew:FORMat(?)	Selects the subview display format.
:DISPlay:DDEMod:SVIew:HSSHift(?)	Selects the Q data half symbol shift for an OQPSK signal.
:DISPlay:DDEMod:SVIew:RADix(?)	Selects the base of symbols in the subview.
:DISPlay:DDEMod:SVIew:X[:SCALE]:OFFSet(?)	Sets the minimum horizontal value (left edge) in the subview.
:DISPlay:DDEMod:SVIew:X[:SCALE]:RANGe(?)	Sets the horizontal full-scale in the subview.
:DISPlay:DDEMod:SVIew:Y[:SCALE]:FIT	Runs auto-scale on the subview.
:DISPlay:DDEMod:SVIew:Y[:SCALE]:FULL	Sets the vertical axis to the default full-scale value in the subview.
:DISPlay:DDEMod:SVIew:Y[:SCALE]:MAXimum(?)	Sets the maximum vertical value (top end) in the CCDF subview.
:DISPlay:DDEMod:SVIew:Y[:SCALE]:MINimum(?)	Sets the minimum vertical value (top end) in the CCDF subview.
:DISPlay:DDEMod:SVIew:Y[:SCALE]:OFFSet(?)	Sets the minimum vertical value (bottom) in the subview.
:DISPlay:DDEMod:SVIew:Y[:SCALE]:RANGe(?)	Sets the vertical full-scale in the subview.

Table 2- 16: :DISPlay commands (Option) (Cont.)

Header	Description
:DISPlay:RFID:DDEMod subgroup	Main view and subview related in the RFID analysis.
:DISPlay:RFID:DDEMod:MView:AREA[:PERCent](?)	Sets the percentage of display area.
:DISPlay:RFID:DDEMod:MView:BURSt[:NUMBer](?)	Sets the burst number to display the measurement result.
:DISPlay:RFID:DDEMod:MView:EDGE[:NUMBer](?)	Sets the edge number to display the measurement result.
:DISPlay:RFID:DDEMod:MView:ENvelope[:NUMBer](?)	Sets the envelope number to display the measurement result.
:DISPlay:RFID:DDEMod:MView:GUIDeline[:STATe](?)	Determines whether to display the guideline in the main view.
:DISPlay:RFID:DDEMod:MView:X[:SCALE]:OFFSet(?)	Sets the minimum horizontal value (left edge) in the main view.
:DISPlay:RFID:DDEMod:MView:X[:SCALE]:PDIVision(?)	Sets the horizontal scale (per division) in the main view.
:DISPlay:RFID:DDEMod:MView:X[:SCALE]:RANGe(?)	Sets the full-scale value of the horizontal axis in the main view.
:DISPlay:RFID:DDEMod:MView:Y[:SCALE]:FIT	Runs the auto-scale on the main view.
:DISPlay:RFID:DDEMod:MView:Y[:SCALE]:FULL	Sets the vertical axis in the main view to the default full-scale value.
:DISPlay:RFID:DDEMod:MView:Y[:SCALE]:OFFSet(?)	Sets the minimum vertical value (bottom) in the main view.
:DISPlay:RFID:DDEMod:MView:Y[:SCALE]:PDIVision(?)	Sets the vertical scale (per division) in the main view.
:DISPlay:RFID:DDEMod:MView:Y[:SCALE]:RANGe(?)	Sets full-scale value of the vertical axis in the main view.
:DISPlay:RFID:DDEMod:SVlew:AREA[:PERCent](?)	Sets the percentage of display area.
:DISPlay:RFID:DDEMod:SVlew:BURSt[:NUMBer](?)	Sets the burst number to display the measurement result.
:DISPlay:RFID:DDEMod:SVlew:EDGE[:NUMBer](?)	Sets the edge number to display the measurement result.
:DISPlay:RFID:DDEMod:SVlew:ENvelope[:NUMBer](?)	Sets the envelope number to display the measurement result.
:DISPlay:RFID:DDEMod:SVlew:FORMat(?)	Selects the display format of the subview.
:DISPlay:RFID:DDEMod:SVlew:GUIDeline[:STATe](?)	Determines whether to display the guideline in the subview.
:DISPlay:RFID:DDEMod:SVlew:X[:SCALE]:OFFSet(?)	Sets the minimum horizontal value (left edge) in the subview.
:DISPlay:RFID:DDEMod:SVlew:X[:SCALE]:PDIVision(?)	Sets the horizontal scale (time per division) in the subview.
:DISPlay:RFID:DDEMod:SVlew:X[:SCALE]:RANGe(?)	Sets full-scale value of the horizontal axis in the subview.
:DISPlay:RFID:DDEMod:SVlew:Y[:SCALE]:FIT	Runs the auto-scale on the subview.
:DISPlay:RFID:DDEMod:SVlew:Y[:SCALE]:FULL	Sets the vertical axis in the subview to the default full-scale value.
:DISPlay:RFID:DDEMod:SVlew:Y[:SCALE]:OFFSet(?)	Sets the minimum vertical value (bottom) in the subview.
:DISPlay:RFID:DDEMod:SVlew:Y[:SCALE]:PDIVision(?)	Sets the vertical scale (per division) in the time domain display.
:DISPlay:RFID:DDEMod:SVlew:Y[:SCALE]:RANGe(?)	Sets full-scale value of the vertical axis in the subview.
:DISPlay:RFID:SPECTrum subgroup	Spectrum view related in the RFID analysis.
:DISPlay:RFID:SPECTrum:X[:SCALE]:OFFSet(?)	Sets the minimum horizontal, or frequency, value (left edge).
:DISPlay:RFID:SPECTrum:X[:SCALE]:PDIVision(?)	Sets the horizontal, or frequency, scale (per division).
:DISPlay:RFID:SPECTrum:Y[:SCALE]:FIT	Runs the auto-scale on the spectrum view.
:DISPlay:RFID:SPECTrum:Y[:SCALE]:FULL	Sets the vertical axis to the default full-scale value.
:DISPlay:RFID:SPECTrum:Y[:SCALE]:OFFSet(?)	Sets the minimum vertical, or amplitude, value (bottom).
:DISPlay:RFID:SPECTrum:Y[:SCALE]:PDIVision(?)	Sets the vertical, or amplitude, scale (per division).

Table 2-16: :DISPlay commands (Option) (Cont.)

Header	Description
:DISPlay:RFID:WAVeform subgroup	Time domain display related in the RFID analysis.
:DISPlay:RFID:WAVeform:X[:SCALe]:OFFSet(?)	Sets the minimum value of the horizontal axis (left edge).
:DISPlay:RFID:WAVeform:X[:SCALe]:PDIVision(?)	Sets the horizontal, or time, scale (per division).
:DISPlay:RFID:WAVeform:Y[:SCALe]:FIT	Runs the auto-scale on the time domain display.
:DISPlay:RFID:WAVeform:Y[:SCALe]:FULL	Sets the vertical axis to the default full-scale value.
:DISPlay:RFID:WAVeform:Y[:SCALe]:OFFSet(?)	Sets the minimum value (bottom) of the vertical axis.
:DISPlay:RFID:WAVeform:Y[:SCALe]:PDIVision(?)	Sets the vertical axis scale (per division).
:DISPlay:SSource:MVlew subgroup	Main view related in the signal source analysis.
:DISPlay:SSource:MVlew:X[:SCALe]:OFFSet(?)	Sets the minimum horizontal value (left edge) in the main view.
:DISPlay:SSource:MVlew:X[:SCALe]:PDIVision(?)	Sets the horizontal scale (per division) in the main view.
:DISPlay:SSource:MVlew:X[:SCALe]:RANGe(?)	Sets the full-scale value of the horizontal axis in the main view.
:DISPlay:SSource:MVlew:X[:SCALe]:STARt(?)	Sets the minimum horizontal value (left edge) in the main view.
:DISPlay:SSource:MVlew:X[:SCALe]:STOP(?)	Sets the maximum horizontal value (right edge) in the main view.
:DISPlay:SSource:MVlew:Y[:SCALe]:FIT	Runs the auto-scale on the main view.
:DISPlay:SSource:MVlew:Y[:SCALe]:FULL	Sets the vertical axis in the main view to the default full-scale value.
:DISPlay:SSource:MVlew:Y[:SCALe]:OFFSet(?)	Sets the minimum vertical value (bottom) in the main view.
:DISPlay:SSource:MVlew:Y[:SCALe]:PDIVision(?)	Sets the vertical scale (per division) in the main view.
:DISPlay:SSource:MVlew:Y[:SCALe]:RANGe(?)	Sets full-scale value of the vertical axis in the main view.
:DISPlay:SSource:SVlew subgroup	Subview related in the signal source analysis.
:DISPlay:SSource:SVlew:COLor[:SCALe]:OFFSet(?)	Sets the minimum value (bottom) of the color axis in the subview.
:DISPlay:SSource:SVlew:COLor[:SCALe]:RANGe(?)	Sets full-scale value of the color axis in the subview.
:DISPlay:SSource:SVlew:FORMat(?)	Selects the display format of the subview.
:DISPlay:SSource:SVlew:X[:SCALe]:OFFSet(?)	Sets the minimum horizontal value (left edge) in the subview.
:DISPlay:SSource:SVlew:X[:SCALe]:PDIVision(?)	Sets the horizontal scale (per division) in the subview.
:DISPlay:SSource:SVlew:X[:SCALe]:RANGe(?)	Sets the full-scale value of the horizontal axis in the subview.
:DISPlay:SSource:SVlew:X[:SCALe]:STARt(?)	Sets the minimum horizontal value (left edge) in the subview.
:DISPlay:SSource:SVlew:X[:SCALe]:STOP(?)	Sets the maximum horizontal value (right edge) in the subview.
:DISPlay:SSource:SVlew:Y[:SCALe]:FIT	Runs the auto-scale on the subview.
:DISPlay:SSource:SVlew:Y[:SCALe]:FULL	Sets the vertical axis in the subview to the default full-scale value.
:DISPlay:SSource:SVlew:Y[:SCALe]:OFFSet(?)	Sets the minimum vertical value (bottom) in the subview.
:DISPlay:SSource:SVlew:Y[:SCALe]:PDIVision(?)	Sets the vertical scale (per division) in the subview.
:DISPlay:SSource:SVlew:Y[:SCALe]:PLINe(?)	Sets the vertical scale (the number of frames per line) in the subview.
:DISPlay:SSource:SVlew:Y[:SCALe]:RANGe(?)	Sets full-scale value of the vertical axis in the subview.

Table 2- 16: :DISPlay commands (Option) (Cont.)

Header	Description
:DISPlay:SSource:SPECTrum subgroup	Spectrum display related in the Signal source analysis.
:DISPlay:SSource:SPECTrum:X[:SCALE]:OFFSet(?)	Sets the minimum horizontal, or frequency, value (left edge).
:DISPlay:SSource:SPECTrum:X[:SCALE]:PDIVision(?)	Sets the horizontal, or frequency, scale (per division).
:DISPlay:SSource:SPECTrum:Y[:SCALE]:FIT	Runs the auto-scale on the spectrum view.
:DISPlay:SSource:SPECTrum:Y[:SCALE]:FULL	Sets the vertical axis to the default full-scale value in the spectrum view.
:DISPlay:SSource:SPECTrum:Y[:SCALE]:OFFSet(?)	Sets the minimum vertical, or amplitude, value (bottom).
:DISPlay:SSource:SPECTrum:Y[:SCALE]:PDIVision(?)	Sets the vertical, or amplitude, scale (per division).
:DISPlay:SSource:TFRequency subgroup	Three-dimensional view related in the signal source analysis.
:DISPlay:SSource:TFRequency:NGRam:COLor[:SCALE] :OFFSet(?)	Sets the minimum value (bottom) of the color, or C/N, axis.
:DISPlay:SSource:TFRequency:NGRam:COLor[:SCALE] :RANGe(?)	Sets full-scale value of the color, or C/N, axis.
:DISPlay:SSource:TFRequency:NGRam:X[:SCALE]:START (?)	Sets the minimum horizontal, or frequency, value (left edge).
:DISPlay:SSource:TFRequency:NGRam:X[:SCALE]:STOP (?)	Sets the maximum horizontal, or frequency, value (right edge).
:DISPlay:SSource:TFRequency:NGRam:Y[:SCALE] :OFFSet(?)	Sets the minimum vertical, or frame number, value (bottom).
:DISPlay:SSource:TFRequency:NGRam:Y[:SCALE]:PLINe (?)	Sets the vertical scale (the number of frames per line).
:DISPlay:SSource:WAVeform subgroup	Time domain display related in the signal source analysis.
:DISPlay:SSource:WAVeform:X[:SCALE]:OFFSet(?)	Sets the minimum value of the horizontal axis (left edge).
:DISPlay:SSource:WAVeform:X[:SCALE]:PDIVision(?)	Sets the horizontal, or time, scale (per division).
:DISPlay:SSource:WAVeform:Y[:SCALE]:FIT	Runs the auto-scale on the time domain display.
:DISPlay:SSource:WAVeform:Y[:SCALE]:FULL	Sets the vertical axis to the default full-scale value.
:DISPlay:SSource:WAVeform:Y[:SCALE]:OFFSet(?)	Sets the minimum value (bottom) of the vertical axis.
:DISPlay:SSource:WAVeform:Y[:SCALE]:PDIVision(?)	Sets the vertical axis scale (per division).
Option 23 W-CDMA uplink analysis related	
:DISPlay:AC3Gpp subgroup	W-CDMA ACLR measurement related.
:DISPlay:AC3Gpp:X[:SCALE]:OFFSet(?)	Sets the minimum horizontal value (left edge).
:DISPlay:AC3Gpp:X[:SCALE]:RANGe(?)	Defines the display area along the horizontal axis.
:DISPlay:AC3Gpp:Y[:SCALE]:FIT	Runs auto-scale.
:DISPlay:AC3Gpp:Y[:SCALE]:FULL	Sets the vertical axis to the default full-scale value.
:DISPlay:AC3Gpp:Y[:SCALE]:OFFSet(?)	Sets the minimum vertical value (bottom).
:DISPlay:AC3Gpp:Y[:SCALE]:RANGe(?)	Sets the vertical full-scale.

Table 2- 16: :DISPlay commands (Option) (Cont.)

Header	Description
:DISPlay:UL3Gpp subgroup	W-CDMA uplink analysis related.
:DISPlay:UL3Gpp:AVIew:SHORtcode(?)	Selects the short code to display.
:DISPlay:UL3Gpp:AVIew:SRATE(?)	Selects the symbol rate for analysis.
:DISPlay:UL3Gpp:AVIew:TSLot(?)	Selects the time slot to display.
:DISPlay:UL3Gpp:MVIew:COLor[:SCALe]:OFFSet(?)	Sets the minimum color-axis value (bottom) in the main view.
:DISPlay:UL3Gpp:MVIew:COLor[:SCALe]:RANGe(?)	Sets the color-axis full-scale in the main view.
:DISPlay:UL3Gpp:MVIew:FORMat(?)	Selects the main view display format.
:DISPlay:UL3Gpp:MVIew:RADix(?)	Selects the base of symbols in the main view.
:DISPlay:UL3Gpp:MVIew:X[:SCALe]:OFFSet(?)	Sets the minimum horizontal value (left edge) of the main view.
:DISPlay:UL3Gpp:MVIew:X[:SCALe]:RANGe(?)	Sets the horizontal full-scale in the main view.
:DISPlay:UL3Gpp:MVIew:Y[:SCALe]:FIT	Runs auto-scale on the main view.
:DISPlay:UL3Gpp:MVIew:Y[:SCALe]:FULL	Sets the main view's vertical axis to the default full-scale value.
:DISPlay:UL3Gpp:MVIew:Y[:SCALe]:OFFSet(?)	Sets the minimum vertical value (bottom) in the main view.
:DISPlay:UL3Gpp:MVIew:Y[:SCALe]:PUNit(?)	Selects the unit for the main view's vertical axis.
:DISPlay:UL3Gpp:MVIew:Y[:SCALe]:RANGe(?)	Sets the vertical full-scale in the main view.
:DISPlay:UL3Gpp:SVIew:COLor[:SCALe]:OFFSet(?)	Sets the minimum color-axis value (bottom) in the subview.
:DISPlay:UL3Gpp:SVIew:COLor[:SCALe]:RANGe(?)	Sets the color-axis full-scale in the subview.
:DISPlay:UL3Gpp:SVIew:FORMat(?)	Selects the subview display format.
:DISPlay:UL3Gpp:SVIew:RADix(?)	Selects the base of symbols in the subview.
:DISPlay:UL3Gpp:SVIew:X[:SCALe]:OFFSet(?)	Sets the minimum horizontal value (left edge) in the subview.
:DISPlay:UL3Gpp:SVIew:X[:SCALe]:RANGe(?)	Sets the horizontal full-scale in the subview.
:DISPlay:UL3Gpp:SVIew:Y[:SCALe]:FIT	Runs auto-scale on the subview.
:DISPlay:UL3Gpp:SVIew:Y[:SCALe]:FULL	Sets the subview's vertical axis to the default full-scale value.
:DISPlay:UL3Gpp:SVIew:Y[:SCALe]:OFFSet(?)	Sets the minimum vertical value (bottom) in the subview.
:DISPlay:UL3Gpp:SVIew:Y[:SCALe]:PUNit(?)	Selects the unit for the subview's vertical axis.
:DISPlay:UL3Gpp:SVIew:Y[:SCALe]:RANGe(?)	Sets the vertical full-scale in the subview.
Option 24 GSM/EDGE analysis related	
:DISPlay:GSMedge:DDEMod subgroup	Main view and subview related in the GSM/EDGE analysis.
:DISPlay:GSMedge:DDEMod:MVIew:FILTer:EINVerse(?)	Determines whether to enable the EDGE inverse filter in the main view.
:DISPlay:GSMedge:DDEMod:MVIew:FORMat(?)	Selects the main view display format.
:DISPlay:GSMedge:DDEMod:MVIew:STIme(?)	Sets the slice time on the constellation view.
:DISPlay:GSMedge:DDEMod:MVIew:X[:SCALe]:OFFSet(?)	Sets the minimum horizontal value (left edge) in the main view.
:DISPlay:GSMedge:DDEMod:MVIew:X[:SCALe]:RANGe(?)	Sets the horizontal full-scale in the main view.
:DISPlay:GSMedge:DDEMod:MVIew:Y[:SCALe]:FIT	Runs auto-scale on the main view.
:DISPlay:GSMedge:DDEMod:MVIew:Y[:SCALe]:FULL	Sets the main view's vertical axis to the default full-scale value.

Table 2- 16: :DISPlay commands (Option) (Cont.)

Header	Description
:DISPlay:GSMedge:DDEMod:MVlew:Y[:SCALe]:OFFSet(?)	Sets the minimum vertical value (bottom) in the main view.
:DISPlay:GSMedge:DDEMod:MVlew:Y[:SCALe]:RANGe(?)	Sets the vertical full-scale in the main view.
:DISPlay:GSMedge:DDEMod:SVlew:FILTer:EINVerse(?)	Determines whether to enable the EDGE inverse filter in the subview.
:DISPlay:GSMedge:DDEMod:SVlew:FORMat(?)	Selects the subview display format.
:DISPlay:GSMedge:DDEMod:SVlew:STIME(?)	Sets the slice time on the constellation view.
:DISPlay:GSMedge:DDEMod:SVlew:X[:SCALe]:OFFSet(?)	Sets the minimum horizontal value (left edge) in the subview.
:DISPlay:GSMedge:DDEMod:SVlew:X[:SCALe]:RANGe(?)	Sets the horizontal full-scale in the subview.
:DISPlay:GSMedge:DDEMod:SVlew:Y[:SCALe]:FIT	Runs auto-scale on the subview.
:DISPlay:GSMedge:DDEMod:SVlew:Y[:SCALe]:FULL	Sets the vertical axis to the default full-scale value in the subview.
:DISPlay:GSMedge:DDEMod:SVlew:Y[:SCALe]:OFFSet(?)	Sets the minimum vertical value (bottom) in the subview.
:DISPlay:GSMedge:DDEMod:SVlew:Y[:SCALe]:RANGe(?)	Sets the vertical full-scale in the subview.
:DISPlay:GSMedge:SPECTrum subgroup	Spectrum display related in the GSM/EDGE analysis.
:DISPlay:GSMedge:SPECTrum:BMARker:STATe(?)	Turns on or off the spurious marker in the spurious measurement.
:DISPlay:GSMedge:SPECTrum:X[:SCALe]:OFFSet(?)	Sets the minimum horizontal value (start frequency).
:DISPlay:GSMedge:SPECTrum:X[:SCALe]:PDIVision(?)	Sets the horizontal scale (span/div).
:DISPlay:GSMedge:SPECTrum:Y[:SCALe]:FIT	Runs auto-scale.
:DISPlay:GSMedge:SPECTrum:Y[:SCALe]:FULL	Sets the vertical axis to the default full-scale value.
:DISPlay:GSMedge:SPECTrum:Y[:SCALe]:OFFSet(?)	Sets the minimum vertical, or amplitude, value (bottom).
:DISPlay:GSMedge:SPECTrum:Y[:SCALe]:PDIVision(?)	Sets the vertical, or amplitude, scale per division.
:DISPlay:GSMedge:WAVEform subgroup	Time domain display related in the GSM/EDGE analysis.
:DISPlay:GSMedge:WAVEform:BURSt(?)	Selects how to expand waveform in the power versus time measurement
:DISPlay:GSMedge:WAVEform:X[:SCALe]:OFFSet(?)	Sets the minimum horizontal, or time, value (left edge).
:DISPlay:GSMedge:WAVEform:X[:SCALe]:PDIVision(?)	Sets the horizontal, or time, scale per division.
:DISPlay:GSMedge:WAVEform:Y[:SCALe]:FIT	Runs auto-scale.
:DISPlay:GSMedge:WAVEform:Y[:SCALe]:FULL	Sets the vertical axis to the default full-scale value.
:DISPlay:GSMedge:WAVEform:Y[:SCALe]:OFFSet(?)	Sets the minimum vertical, or amplitude, value (bottom).
:DISPlay:GSMedge:WAVEform:Y[:SCALe]:PDIVision(?)	Sets the vertical, or amplitude, scale.
Option 25 cdma2000 analysis related (:Standard = :FLCDMA2K :RLCDMA2K)	
:DISPlay:Standard:CCDF subgroup	CCDF measurement related.
:DISPlay:Standard:CCDF:LINE:GAUSSian[:STATe](?)	Sets whether to display the Gaussian line on the CCDF view.
:DISPlay:Standard:CCDF:LINE:REFerence[:STATe](?)	Sets whether to display the reference line on the CCDF view.
:DISPlay:Standard:CCDF:LINE:REFerence:STORe	Stores a new reference line.
:DISPlay:Standard:CCDF:X[:SCALe]:AUTO(?)	Determines whether to set the horizontal scale automatically.
:DISPlay:Standard:CCDF:X[:SCALe]:MAXimum(?)	Sets the horizontal maximum value (right edge) in the CCDF view.
:DISPlay:Standard:CCDF:X[:SCALe]:OFFSet(?)	Sets the minimum horizontal value (left edge) in the CCDF view.

Table 2- 16: :DISPlay commands (Option) (Cont.)

Header	Description
:DISPlay:Standard:CCDF:Y[:SCALE]:FIT	Runs auto-scale on the CCDF view.
:DISPlay:Standard:CCDF:Y[:SCALE]:FULL	Sets the vertical axis to the default full-scale value in the CCDF view.
:DISPlay:Standard:CCDF:Y[:SCALE]:MAXimum(?)	Sets the maximum vertical value (top) in the CCDF view.
:DISPlay:Standard:CCDF:Y[:SCALE]:MINimum(?)	Sets the minimum vertical value (bottom) in the CCDF view.
:DISPlay:Standard:DDEMod subgroup	Digital modulation analysis related.
:DISPlay:Standard:DDEMod:MVleW:CORDer(?)	Sets the code order.
:DISPlay:Standard:DDEMod:MVleW:FORMat(?)	Selects the main view display format.
:DISPlay:Standard:DDEMod:MVleW:X[:SCALE]:OFFSet(?)	Sets the minimum horizontal value (left edge) in the main view.
:DISPlay:Standard:DDEMod:MVleW:X[:SCALE]:RANGe(?)	Sets the horizontal full-scale value in the main view.
:DISPlay:Standard:DDEMod:MVleW:Y[:SCALE]:FIT	Runs auto-scale on the main view.
:DISPlay:Standard:DDEMod:MVleW:Y[:SCALE]:FULL	Sets the main view's vertical axis to the default full-scale value.
:DISPlay:Standard:DDEMod:MVleW:Y[:SCALE]:OFFSet(?)	Sets the minimum vertical value (bottom) in the main view.
:DISPlay:Standard:DDEMod:MVleW:Y[:SCALE]:PUNit(?)	Sets the unit of the vertical axis in the main view.
:DISPlay:Standard:DDEMod:MVleW:Y[:SCALE]:RANGe(?)	Sets the vertical full-scale value in the main view.
:DISPlay:Standard:DDEMod:SVleW:FORMat(?)	Selects the subview display format.
:DISPlay:Standard:DDEMod:SVleW:X[:SCALE]:OFFSet(?)	Sets the minimum horizontal value (left edge) in the subview.
:DISPlay:Standard:DDEMod:SVleW:X[:SCALE]:RANGe(?)	Sets the horizontal full-scale value in the subview.
:DISPlay:Standard:DDEMod:SVleW:Y[:SCALE]:FIT	Runs auto-scale on the subview.
:DISPlay:Standard:DDEMod:SVleW:Y[:SCALE]:FULL	Sets the subview's vertical axis to the default full-scale value.
:DISPlay:Standard:DDEMod:SVleW:Y[:SCALE]:OFFSet(?)	Sets the minimum vertical value (bottom) in the subview.
:DISPlay:Standard:DDEMod:SVleW:Y[:SCALE]:RANGe(?)	Sets the vertical full-scale value in the subview.
:DISPlay:Standard:SPEctrum subgroup	Spectrum view related.
:DISPlay:Standard:SPEctrum:X[:SCALE]:OFFSet(?)	Sets the minimum horizontal value (left edge) in the spectrum view.
:DISPlay:Standard:SPEctrum:X[:SCALE]:PDIVision(?)	Sets the horizontal scale in the spectrum view.
:DISPlay:Standard:SPEctrum:Y[:SCALE]:FIT	Runs auto-scale on the spectrum view.
:DISPlay:Standard:SPEctrum:Y[:SCALE]:FULL	Sets the vertical axis to the default full-scale value.
:DISPlay:Standard:SPEctrum:Y[:SCALE]:OFFSet(?)	Sets the minimum vertical value (bottom) in the spectrum view.
:DISPlay:Standard:SPEctrum:Y[:SCALE]:PDIVision(?)	Sets the vertical scale in the spectrum view.
:DISPlay:RLCDMA2K:WAVEform subgroup	Time domain display related.
:DISPlay:RLCDMA2K:WAVEform:X[:SCALE]:OFFSet(?)	Sets the minimum horizontal value in the time domain display.
:DISPlay:RLCDMA2K:WAVEform:X[:SCALE]:PDIVision(?)	Sets the horizontal or time scale per division in the spectrum view.
:DISPlay:RLCDMA2K:WAVEform:Y[:SCALE]:FIT	Runs auto-scale on the time domain display.
:DISPlay:RLCDMA2K:WAVEform:Y[:SCALE]:FULL	Sets the vertical axis to the default full scale.
:DISPlay:RLCDMA2K:WAVEform:Y[:SCALE]:OFFSet(?)	Sets the minimum vertical value in the time domain display.
:DISPlay:RLCDMA2K:WAVEform:Y[:SCALE]:PDIVision(?)	Sets the vertical scale per division in the time domain display.

Table 2- 16: :DISPlay commands (Option) (Cont.)

Header	Description
Option 26 1xEV-DO analysis related (:Standard = :FL1XEVD0 :RL1XEVD0)	
:DISPlay:Standard:CCDF subgroup	CCDF measurement related.
:DISPlay:Standard:CCDF:LINE:GAUSSian[:STATE](?)	Sets whether to display the Gaussian line on the CCDF view.
:DISPlay:Standard:CCDF:LINE:REFerence[:STATE](?)	Sets whether to display the reference line on the CCDF view.
:DISPlay:Standard:CCDF:LINE:REFerence:STORe	Stores a new reference line.
:DISPlay:Standard:CCDF:X[:SCALe]:AUTO(?)	Determines whether to set the horizontal scale automatically.
:DISPlay:Standard:CCDF:X[:SCALe]:MAXimum(?)	Sets the horizontal maximum value (right edge) in the CCDF view.
:DISPlay:Standard:CCDF:X[:SCALe]:OFFSet(?)	Sets the minimum horizontal value (left edge) in the CCDF view.
:DISPlay:Standard:CCDF:Y[:SCALe]:FIT	Runs auto-scale on the CCDF view.
:DISPlay:Standard:CCDF:Y[:SCALe]:FULL	Sets the vertical axis to the default full-scale value in the CCDF view.
:DISPlay:Standard:CCDF:Y[:SCALe]:MAXimum(?)	Sets the maximum vertical value (top) in the CCDF view.
:DISPlay:Standard:CCDF:Y[:SCALe]:MINimum(?)	Sets the minimum vertical value (bottom) in the CCDF view.
:DISPlay:Standard:DDEMod subgroup	Digital modulation analysis related.
:DISPlay:Standard:DDEMod:MVliew:CORDer(?)	Sets the code order.
:DISPlay:Standard:DDEMod:MVliew:FORMat(?)	Selects the main view display format.
:DISPlay:Standard:DDEMod:MVliew:X[:SCALe]:OFFSet(?)	Sets the minimum horizontal value (left edge) in the main view.
:DISPlay:Standard:DDEMod:MVliew:X[:SCALe]:RANGe(?)	Sets the horizontal full-scale value in the main view.
:DISPlay:Standard:DDEMod:MVliew:Y[:SCALe]:FIT	Runs auto-scale on the main view.
:DISPlay:Standard:DDEMod:MVliew:Y[:SCALe]:FULL	Sets the main view's vertical axis to the default full-scale value.
:DISPlay:Standard:DDEMod:MVliew:Y[:SCALe]:OFFSet(?)	Sets the minimum vertical value (bottom) in the main view.
:DISPlay:Standard:DDEMod:MVliew:Y[:SCALe]:PUNit(?)	Sets the unit of the vertical axis in the main view.
:DISPlay:Standard:DDEMod:MVliew:Y[:SCALe]:RANGe(?)	Sets the vertical full-scale value in the main view.
:DISPlay:Standard:DDEMod:SVliew:FORMat(?)	Selects the subview display format.
:DISPlay:Standard:DDEMod:SVliew:X[:SCALe]:OFFSet(?)	Sets the minimum horizontal value (left edge) in the subview.
:DISPlay:Standard:DDEMod:SVliew:X[:SCALe]:RANGe(?)	Sets the horizontal full-scale value in the subview.
:DISPlay:Standard:DDEMod:SVliew:Y[:SCALe]:FIT	Runs auto-scale on the subview.
:DISPlay:Standard:DDEMod:SVliew:Y[:SCALe]:FULL	Sets the subview's vertical axis to the default full-scale value.
:DISPlay:Standard:DDEMod:SVliew:Y[:SCALe]:OFFSet(?)	Sets the minimum vertical value (bottom) in the subview.
:DISPlay:Standard:DDEMod:SVliew:Y[:SCALe]:RANGe(?)	Sets the vertical full-scale value in the subview.
:DISPlay:Standard:SPECTrum subgroup	Spectrum view related.
:DISPlay:Standard:SPECTrum:X[:SCALe]:OFFSet(?)	Sets the minimum horizontal value (left edge) in the spectrum view.
:DISPlay:Standard:SPECTrum:X[:SCALe]:PDIVision(?)	Sets the horizontal scale in the spectrum view.
:DISPlay:Standard:SPECTrum:Y[:SCALe]:FIT	Runs auto-scale on the spectrum view.
:DISPlay:Standard:SPECTrum:Y[:SCALe]:FULL	Sets the vertical axis to the default full-scale value.

Table 2- 16: :DISPlay commands (Option) (Cont.)

Header	Description
:DISPlay:Standard:SPECTrum:Y[:SCALe]:OFFSet(?)	Sets the minimum vertical value (bottom) in the spectrum view.
:DISPlay:Standard:SPECTrum:Y[:SCALe]:PDIVision(?)	Sets the vertical scale in the spectrum view.
:DISPlay:FL1XEVD0:WAVEform subgroup	Time domain display related.
:DISPlay:FL1XEVD0:WAVEform:X[:SCALe]:OFFSet(?)	Sets the minimum horizontal value in the time domain display.
:DISPlay:FL1XEVD0:WAVEform:X[:SCALe]:PDIVision(?)	Sets the horizontal or time scale per division in the spectrum view.
:DISPlay:FL1XEVD0:WAVEform:Y[:SCALe]:FIT	Runs auto-scale on the time domain display.
:DISPlay:FL1XEVD0:WAVEform:Y[:SCALe]:FULL	Sets the vertical axis to the default full scale.
:DISPlay:FL1XEVD0:WAVEform:Y[:SCALe]:OFFSet(?)	Sets the minimum vertical value in the time domain display.
:DISPlay:FL1XEVD0:WAVEform:Y[:SCALe]:PDIVision(?)	Sets the vertical scale per division in the time domain display.
Option 27 3GPP-R5 analysis related (:Standard = :SADLR5_3GPP :SAULR5_3GPP)	
:DISPlay:DLR5_3GPP subgroup	Related to modulation analysis for 3GPP-R5 downlink
:DISPlay:DLR5_3GPP:AVIew:CCODE(?)	Sets the channelization code to position the marker.
:DISPlay:DLR5_3GPP:AVIew:MSLot:HEAD(?)	Sets the number of the head of the time slot to be displayed.
:DISPlay:DLR5_3GPP:AVIew:MSLot[:STATe](?)	Determines whether to display the multiple or the single slot.
:DISPlay:DLR5_3GPP:AVIew:SHORTcode(?)	Selects the short code to display.
:DISPlay:DLR5_3GPP:AVIew:SRATE(?)	Selects the symbol rate for downlink analysis.
:DISPlay:DLR5_3GPP:AVIew:SSCHpart(?)	Determines whether to show SCH.
:DISPlay:DLR5_3GPP:AVIew:TSLot(?)	Selects the time slot to display.
:DISPlay:DLR5_3GPP:MVIew:SVIew:COLor[:SCALe] :OFFSet(?)	Sets the minimum color-axis value (bottom) in the main view.
:DISPlay:DLR5_3GPP:MVIew:SVIew:COLor[:SCALe] :RANGe(?)	Sets the color-axis full scale in the main view.
:DISPlay:DLR5_3GPP:MVIew:SVIew:FORMat(?)	Selects the main view display format.
:DISPlay:DLR5_3GPP:MVIew:SVIew:RADix(?)	Selects the base of symbols in the main view.
:DISPlay:DLR5_3GPP:MVIew:SVIew:X[:SCALe]:OFFSet (?)	Sets the minimum horizontal value (left edge) in the main view.
:DISPlay:DLR5_3GPP:MVIew:SVIew:X[:SCALe]:RANGe (?)	Sets the horizontal full scale in the main view.
:DISPlay:DLR5_3GPP:MVIew:SVIew:Y[:SCALe]:FIT	Runs auto-scale on the main view.
:DISPlay:DLR5_3GPP:MVIew:SVIew:Y[:SCALe]:FULL	Sets the main view's vertical axis to the default full scale.
:DISPlay:DLR5_3GPP:MVIew:SVIew:Y[:SCALe]:OFFSet (?)	Sets the minimum vertical value (bottom) in the main view.
:DISPlay:DLR5_3GPP:MVIew:SVIew:Y[:SCALe]:PUNit(?)	Selects the unit for the main view's vertical axis.
:DISPlay:DLR5_3GPP:MVIew:SVIew:Y[:SCALe]:RANGe (?)	Sets the vertical full scale in the main view.

Table 2- 16: :DISPlay commands (Option) (Cont.)

Header	Description
:DISPlay:Standard subgroup	Related to spectrum analysis for 3GPP-R5
:DISPlay:Standard:SPECTrum:X[:SCALE]:OFFSet(?)	Sets the minimum horizontal value (left edge).
:DISPlay:Standard:SPECTrum:X[:SCALE]:PDIVision(?)	Defines the display area along the horizontal axis.
:DISPlay:Standard:SPECTrum:Y[:SCALE]:FIT	Runs auto-scale.
:DISPlay:Standard:SPECTrum:Y[:SCALE]:FULL	Sets the vertical axis to the default full scale.
:DISPlay:Standard:SPECTrum:Y[:SCALE]:OFFSet(?)	Sets the minimum vertical value (bottom).
:DISPlay:Standard:SPECTrum:Y[:SCALE]:PDIVision(?)	Sets the vertical full scale.
:DISPlay:ULR5_3GPP subgroup	Related to modulation analysis for 3GPP-R5 uplink
:DISPlay:ULR5_3GPP:AVIew:CNUMber(?)	Sets the channelization code to position the marker.
:DISPlay:ULR5_3GPP:AVIew:SRATe(?)	Selects the symbol rate for downlink analysis.
:DISPlay:ULR5_3GPP:AVIew:TSLot(?)	Selects the time slot to display.
:DISPlay:ULR5_3GPP:MVIew: SVIew:COLor[:SCALE] :OFFSet(?)	Sets the minimum color-axis value (bottom) in the main view.
:DISPlay:ULR5_3GPP:MVIew: SVIew:COLor[:SCALE] :RANGe(?)	Sets the color-axis full scale in the main view.
:DISPlay:ULR5_3GPP:MVIew: SVIew:FORMat(?)	Selects the main view display format.
:DISPlay:ULR5_3GPP:MVIew: SVIew:RADix(?)	Selects the base of symbols in the main view.
:DISPlay:ULR5_3GPP:MVIew: SVIew:X[:SCALE] :OFFSet(?)	Sets the minimum horizontal value (left edge) in the main view.
:DISPlay:ULR5_3GPP:MVIew: SVIew:X[:SCALE] :RANGe(?)	Sets the horizontal full scale in the main view.
:DISPlay:ULR5_3GPP:MVIew: SVIew:Y[:SCALE]:FIT	Runs auto-scale on the main view.
:DISPlay:ULR5_3GPP:MVIew: SVIew:Y[:SCALE]:FULL	Sets the main view's vertical axis to the default full scale.
:DISPlay:ULR5_3GPP:MVIew: SVIew:Y[:SCALE] :OFFSet(?)	Sets the minimum vertical value (bottom) in the main view.
:DISPlay:ULR5_3GPP:MVIew: SVIew:Y[:SCALE]:PUNit(?)	Selects the unit for the main view's vertical axis.
:DISPlay:ULR5_3GPP:MVIew: SVIew:Y[:SCALE] :RANGe(?)	Sets the vertical full scale in the main view.

Table 2- 16: :DISPlay commands (Option) (Cont.)

Header	Description
Option 28 TD-SCDMA analysis related	
:DISPlay:TD_SCDMA:DDEMod subgroup	Main view and subview related in the TD-SCDMA analysis
:DISPlay:TD_SCDMA:DDEMod:MVlew:FORMat(?)	Sets the main view display format.
:DISPlay:TD_SCDMA:DDEMod:MVlew:RADix(?)	Sets the base of symbols on the main view.
:DISPlay:TD_SCDMA:DDEMod:MVlew:X[:SCALe]:OFFSet(?)	Sets the minimum horizontal value (left edge) in the main view.
:DISPlay:TD_SCDMA:DDEMod:MVlew:X[:SCALe]:PDIVisiOn(?)	Sets the horizontal, or time, scale (per division) in the mainview.
:DISPlay:TD_SCDMA:DDEMod:MVlew:X[:SCALe]:RANGe(?)	Sets the horizontal full-scale value in the main view.
:DISPlay:TD_SCDMA:DDEMod:MVlew:Y[:SCALe]:FIT	Runs auto-scale on the main view.
:DISPlay:TD_SCDMA:DDEMod:MVlew:Y[:SCALe]:FULL	Sets the main view vertical axis to the default full-scale value.
:DISPlay:TD_SCDMA:DDEMod:MVlew:Y[:SCALe]:OFFSet(?)	Sets the minimum vertical value in the main view (bottom).
:DISPlay:TD_SCDMA:DDEMod:MVlew:Y[:SCALe]:PDIVisiOn(?)	Sets the vertical, or power, scale (per division) in the main view.
:DISPlay:TD_SCDMA:DDEMod:MVlew:Y[:SCALe]:PUNit(?)	Sets the unit of the vertical axis in the main view.
:DISPlay:TD_SCDMA:DDEMod:MVlew:Y[:SCALe]:RANGe(?)	Sets the main view minimum vertical value (bottom).
:DISPlay:TD_SCDMA:DDEMod:MVlew:ZOOM:MCONtrol[:START]	Sets the zoom to the transmit mask start in the main view.
:DISPlay:TD_SCDMA:DDEMod:MVlew:ZOOM:MCONtrol:END	Sets the zoom to the transmit mask end in the main view.
:DISPlay:TD_SCDMA:DDEMod:MVlew:ZOOM:MCONtrol:MRPower	Sets the zoom to the maximum transmit mid-ramp power in the main view.
:DISPlay:TD_SCDMA:DDEMod:MVlew:ZOOM:MCONtrol:OPower	Sets the zoom to the maximum transmit off power in the main view.
:DISPlay:TD_SCDMA:DDEMod:MVlew:ZOOM:TSlot[:START]	Sets the zoom to the timeslot start in the main view.
:DISPlay:TD_SCDMA:DDEMod:SVlew:FORMat(?)	Sets the subview display format.
:DISPlay:TD_SCDMA:DDEMod:SVlew:RADix(?)	Sets the base of symbols on the subview.
:DISPlay:TD_SCDMA:DDEMod:SVlew:X[:SCALe]:OFFSet(?)	Sets the minimum horizontal value (left edge) in the subview.
:DISPlay:TD_SCDMA:DDEMod:SVlew:X[:SCALe]:PDIVisiOn(?)	Sets the horizontal, or time, scale (per division) in the subview.
:DISPlay:TD_SCDMA:DDEMod:SVlew:X[:SCALe]:RANGe(?)	Sets the horizontal full-scale value in the subview.
:DISPlay:TD_SCDMA:DDEMod:SVlew:Y[:SCALe]:FIT	Runs auto-scale on the subview.
:DISPlay:TD_SCDMA:DDEMod:SVlew:Y[:SCALe]:FULL	Sets the subview vertical axis to the default full-scale value.

Table 2- 16: :DISPlay commands (Option) (Cont.)

Header	Description
:DISPlay:TD_SCDMA:DDEMod:SVIew:Y[:SCALe]:OFFSet(?)	Sets the minimum vertical value (bottom) in the subview.
:DISPlay:TD_SCDMA:DDEMod:SVIew:Y[:SCALe]:PDIVision(?)	Sets the vertical, or power, scale (per division) in the subview.
:DISPlay:TD_SCDMA:DDEMod:SVIew:Y[:SCALe]:PUNit(?)	Sets the unit on the Y, or power, axis in the subview.
:DISPlay:TD_SCDMA:DDEMod:SVIew:Y[:SCALe]:RANGe(?)	Sets the vertical full-scale value in the subview.
:DISPlay:TD_SCDMA:DDEMod:SVIew:ZOOM:MCONtrol[:STARt]	Sets the zoom to the transmit mask start in the subview.
:DISPlay:TD_SCDMA:DDEMod:SVIew:ZOOM:MCONtrol:END	Sets the zoom to the transmit mask end in the subview.
:DISPlay:TD_SCDMA:DDEMod:SVIew:ZOOM:TSLot[:STARt]	Sets the zoom to the timeslot start in the subview.
:DISPlay:TD_SCDMA:SPECTrum subgroup	Spectrum display related in TD-SCDMA modulation analysis
:DISPlay:TD_SCDMA:SPECTrum:X[:SCALe]:OFFSet(?)	Sets the minimum value of the horizontal axis in the spectrum view.
:DISPlay:TD_SCDMA:SPECTrum:X[:SCALe]:PDIVision(?)	Sets the horizontal scale in the spectrum view.
:DISPlay:TD_SCDMA:SPECTrum:Y[:SCALe]:FIT	Runs auto-scale on the spectrum view.
:DISPlay:TD_SCDMA:SPECTrum:Y[:SCALe]:FULL	Sets the vertical axis to the default full-scale value.
:DISPlay:TD_SCDMA:SPECTrum:Y[:SCALe]:OFFSet(?)	Sets the minimum vertical value in the spectrum view.
:DISPlay:TD_SCDMA:SPECTrum:Y[:SCALe]:PDIVision(?)	Sets the vertical (power) scale in the spectrum view.
Option 29 WLAN analysis related	
:DISPlay:M2WLAN:DDEMod subgroup	IEEE802.11n MIMO (2x2) modulation analysis related
:DISPlay:M2WLAN:DDEMod:MVleW:MCONtent(?)	Selects the measurement content of the main view.
:DISPlay:M2WLAN:DDEMod:MVleW:RADix(?)	Selects the base of symbols in the main view.
:DISPlay:M2WLAN:DDEMod:MVleW:RXAntenna[:SElect](?)	Selects the receiving antenna to display data in the main view.
:DISPlay:M2WLAN:DDEMod:MVleW:TYPE(?)	Selects the display type in the main view.
:DISPlay:M2WLAN:DDEMod:MVleW:X[:SCALe]:OFFSet(?)	Sets the minimum value of the horizontal axis in the main view.
:DISPlay:M2WLAN:DDEMod:MVleW:X[:SCALe]:PDIVision(?)	Sets the horizontal scale (time per division) in the time domain display.
:DISPlay:M2WLAN:DDEMod:MVleW:X[:SCALe]:RANGe(?)	Sets the full-scale value of the horizontal axis in the main view.
:DISPlay:M2WLAN:DDEMod:MVleW:Y[:SCALe]:FIT	Runs the auto-scale on the main view.
:DISPlay:M2WLAN:DDEMod:MVleW:Y[:SCALe]:FULL	Sets the vertical axis in the main view to the default full-scale value.
:DISPlay:M2WLAN:DDEMod:MVleW:Y[:SCALe]:OFFSet(?)	Sets the minimum value of the vertical axis in the main view.
:DISPlay:M2WLAN:DDEMod:MVleW:Y[:SCALe]:PDIVision(?)	Sets the vertical scale (per division) in the time domain display.
:DISPlay:M2WLAN:DDEMod:MVleW:Y[:SCALe]:PWUNit(?)	Selects the unit of power for the delay profile in the main view.

Table 2-16: :DISPlay commands (Option) (Cont.)

Header	Description
:DISPlay:M2WLAN:DDEMod:MVlew:Y[:SCALe]:RANGe(?)	Sets the full-scale value of the vertical axis in the main view.
:DISPlay:M2WLAN:DDEMod:MVlew:Y[:SCALe]:UNIT(?)	Selects the unit of the vertical axis for the frequency error measurement.
:DISPlay:M2WLAN:DDEMod:SVlew:FORMat(?)	Selects the display format of the subview.
:DISPlay:M2WLAN:DDEMod:SVlew:MCONtent(?)	Selects the measurement content of the subview.
:DISPlay:M2WLAN:DDEMod:SVlew:RADix(?)	Selects the base of symbols in the subview.
:DISPlay:M2WLAN:DDEMod:SVlew:RXAntenna[:SElect] (?)	Selects the receiving antenna to display data in the subview.
:DISPlay:M2WLAN:DDEMod:SVlew:X[:SCALe]:OFFSet(?)	Sets the minimum value of the horizontal axis in the subview.
:DISPlay:M2WLAN:DDEMod:SVlew:X[:SCALe]:PDIVision (?)	Sets the horizontal scale (time per division) in the time domain display.
:DISPlay:M2WLAN:DDEMod:SVlew:X[:SCALe]:RANGe(?)	Sets the full-scale value of the horizontal axis in the subview.
:DISPlay:M2WLAN:DDEMod:SVlew:Y[:SCALe]:FIT	Runs the auto-scale on the subview.
:DISPlay:M2WLAN:DDEMod:SVlew:Y[:SCALe]:FULL	Sets the vertical axis in the subview to the default full-scale value.
:DISPlay:M2WLAN:DDEMod:SVlew:Y[:SCALe]:OFFSet(?)	Sets the minimum value of the vertical axis in the subview.
:DISPlay:M2WLAN:DDEMod:SVlew:Y[:SCALe]:PDIVision (?)	Sets the vertical scale (per division) in the time domain display.
:DISPlay:M2WLAN:DDEMod:SVlew:Y[:SCALe]:PWUNit(?)	Selects the unit of power for the delay profile in the subview.
:DISPlay:M2WLAN:DDEMod:SVlew:Y[:SCALe]:RANGe(?)	Sets the full-scale value of the vertical axis in the subview.
:DISPlay:M2WLAN:DDEMod:SVlew:Y[:SCALe]:UNIT(?)	Selects the unit of the vertical axis for the frequency error measurement.
:DISPlay:M2WLAN:TFRequency subgroup	IEEE802.11n MIMO (2x2) modulation analysis related
:DISPlay:M2WLAN:TFRequency:ATGRam:COLor[:SCALe] :OFFSet(?)	Sets the minimum color-axis value of the amplitude transogram.
:DISPlay:M2WLAN:TFRequency:ATGRam:COLor[:SCALe] :RANGe(?)	Sets the color-axis scale of the amplitude transogram.
:DISPlay:M2WLAN:TFRequency:ATGRam:X[:SCALe] :OFFSet(?)	Sets the minimum horizontal value of the amplitude transogram.
:DISPlay:M2WLAN:TFRequency:ATGRam:X[:SCALe] :RANGe(?)	Sets the horizontal full-scale of the amplitude transogram.
:DISPlay:M2WLAN:TFRequency:ATGRam:Y[:SCALe] :OFFSet(?)	Sets the minimum vertical value of the amplitude transogram.
:DISPlay:M2WLAN:TFRequency:ATGRam:Y[:SCALe] :PLINe(?)	Sets the vertical scale of the amplitude transogram.
:DISPlay:M2WLAN:TFRequency:DGRam:COLor[:SCALe] :OFFSet(?)	Sets the minimum color-axis value of the delayogram.
:DISPlay:M2WLAN:TFRequency:DGRam:COLor[:SCALe] :RANGe(?)	Sets the color-axis scale of the delayogram.

Table 2- 16: :DISPlay commands (Option) (Cont.)

Header	Description
:DISPlay:M2WLAN:TFRrequency:DGRam:X[:SCALE]:OFFSet(?)	Sets the minimum horizontal value of the delayogram.
:DISPlay:M2WLAN:TFRrequency:DGRam:X[:SCALE]:RANGe(?)	Sets the horizontal full-scale of the delayogram.
:DISPlay:M2WLAN:TFRrequency:DGRam:Y[:SCALE]:OFFSet(?)	Sets the minimum vertical value of the delayogram.
:DISPlay:M2WLAN:TFRrequency:DGRam:Y[:SCALE]:PLINe(?)	Sets the vertical scale of the delayogram.
:DISPlay:M2WLAN:TFRrequency:PTGRam:COLor[:SCALE]:OFFSet(?)	Sets the minimum color-axis value of the phase transfogram.
:DISPlay:M2WLAN:TFRrequency:PTGRam:COLor[:SCALE]:RANGe(?)	Sets the color-axis scale of the phase transfogram.
:DISPlay:M2WLAN:TFRrequency:PTGRam:X[:SCALE]:OFFSet(?)	Sets the minimum horizontal value of the phase transfogram.
:DISPlay:M2WLAN:TFRrequency:PTGRam:X[:SCALE]:RANGe(?)	Sets the horizontal full-scale of the phase transfogram.
:DISPlay:M2WLAN:TFRrequency:PTGRam:Y[:SCALE]:OFFSet(?)	Sets the minimum vertical value of the phase transfogram.
:DISPlay:M2WLAN:TFRrequency:PTGRam:Y[:SCALE]:PLINe(?)	Sets the vertical scale of the phase transfogram.
:DISPlay:SWLAN:DDEMod subgroup	IEEE802.11n (nx1) modulation analysis related
:DISPlay:SWLAN:DDEMod:MVlew:FORMat(?)	Selects the display format in the OFDM linearity measurement.
:DISPlay:SWLAN:DDEMod:MVlew:MCONtent(?)	Selects the measurement content of the main view.
:DISPlay:SWLAN:DDEMod:MVlew:RADix(?)	Selects the base of symbols in the main view.
:DISPlay:SWLAN:DDEMod:MVlew:TYPE(?)	Selects the display type in the main view.
:DISPlay:SWLAN:DDEMod:MVlew:X[:SCALE]:CHANnel:BWIDth(?)	Sets the channel bandwidth for the OFDM flatness measurement.
:DISPlay:SWLAN:DDEMod:MVlew:X[:SCALE]:CPOSition(?)	Selects the carrier position in the OFDM flatness measurement..
:DISPlay:SWLAN:DDEMod:MVlew:X[:SCALE]:OFFSet(?)	Sets the minimum value of the horizontal axis in the main view.
:DISPlay:SWLAN:DDEMod:MVlew:X[:SCALE]:PDIVision(?)	Sets the horizontal scale (time per division) in the time domain display.
:DISPlay:SWLAN:DDEMod:MVlew:X[:SCALE]:RANGe(?)	Sets the full-scale value of the horizontal axis in the main view.
:DISPlay:SWLAN:DDEMod:MVlew:Y[:SCALE]:FIT	Runs the auto-scale on the main view.
:DISPlay:SWLAN:DDEMod:MVlew:Y[:SCALE]:FULL	Sets the vertical axis in the main view to the default full-scale value.
:DISPlay:SWLAN:DDEMod:MVlew:Y[:SCALE]:OFFSet(?)	Sets the minimum value of the vertical axis in the main view.
:DISPlay:SWLAN:DDEMod:MVlew:Y[:SCALE]:PDIVision(?)	Sets the vertical scale (per division) in the time domain display.
:DISPlay:SWLAN:DDEMod:MVlew:Y[:SCALE]:PWUNit(?)	Selects the unit of power for the delay profile in the main view.
:DISPlay:SWLAN:DDEMod:MVlew:Y[:SCALE]:RANGe(?)	Sets the full-scale value of the vertical axis in the main view.
:DISPlay:SWLAN:DDEMod:MVlew:Y[:SCALE]:UNIT(?)	Selects the unit of the vertical axis for the frequency error measurement.

Table 2- 16: :DISPlay commands (Option) (Cont.)

Header	Description
:DISPlay:SWLAN:DDEMod:SVIew:FORMat(?)	Selects the display format of the subview.
:DISPlay:SWLAN:DDEMod:SVIew:MCONtent(?)	Selects the measurement content of the subview.
:DISPlay:SWLAN:DDEMod:SVIew:RADix(?)	Selects the base of symbols in the subview.
:DISPlay:SWLAN:DDEMod:SVIew:X[:SCALe]:CHANnel :BANDwidth[:BWIDTH(?)]	Sets the channel bandwidth for the OFDM flatness measurement.
:DISPlay:SWLAN:DDEMod:SVIew:X[:SCALe]:CPOSition(?)	Selects the carrier position in the OFDM flatness measurement..
:DISPlay:SWLAN:DDEMod:SVIew:X[:SCALe]:OFFSet(?)	Sets the minimum value of the horizontal axis in the subview.
:DISPlay:SWLAN:DDEMod:SVIew:X[:SCALe]:PDIVision(?)	Sets the horizontal scale (time per division) in the time domain display.
:DISPlay:SWLAN:DDEMod:SVIew:X[:SCALe]:RANGe(?)	Sets the full-scale value of the horizontal axis in the subview.
:DISPlay:SWLAN:DDEMod:SVIew:Y[:SCALe]:FIT	Runs the auto-scale on the subview.
:DISPlay:SWLAN:DDEMod:SVIew:Y[:SCALe]:FULL	Sets the vertical axis in the subview to the default full-scale value.
:DISPlay:SWLAN:DDEMod:SVIew:Y[:SCALe]:OFFSet(?)	Sets the minimum value of the vertical axis in the subview.
:DISPlay:SWLAN:DDEMod:SVIew:Y[:SCALe]:PDIVision(?)	Sets the vertical scale (per division) in the time domain display.
:DISPlay:SWLAN:DDEMod:SVIew:Y[:SCALe]:PWUNit(?)	Selects the unit of power for the delay profile in the subview.
:DISPlay:SWLAN:DDEMod:SVIew:Y[:SCALe]:RANGe(?)	Sets the full-scale value of the vertical axis in the subview.
:DISPlay:SWLAN:DDEMod:SVIew:Y[:SCALe]:UNIT(?)	Selects the unit of the vertical axis for the frequency error measurement.
:DISPlay:SWLAN:SPECTrum subgroup	Spectrum view related in the IEEE802.11n (nx1) analysis
:DISPlay:SWLAN:SPECTrum:X[:SCALe]:OFFSet(?)	Sets the minimum value of the horizontal axis in the spectrum view.
:DISPlay:SWLAN:SPECTrum:X[:SCALe]:PDIVision(?)	Sets the horizontal scale (per division) in the spectrum view.
:DISPlay:SWLAN:SPECTrum:Y[:SCALe]:FIT	Runs the auto-scale on the spectrum view.
:DISPlay:SWLAN:SPECTrum:Y[:SCALe]:FULL	Sets the vertical axis to the default full-scale value in the spectrum view.
:DISPlay:SWLAN:SPECTrum:Y[:SCALe]:OFFSet(?)	Sets the minimum value of the vertical axis in the spectrum view.
:DISPlay:SWLAN:SPECTrum:Y[:SCALe]:PDIVision(?)	Sets the vertical scale (per division) in the spectrum view.
:DISPlay:SWLAN:TFRequency subgroup	IEEE802.11n MIMO (2x2) modulation analysis related
:DISPlay:SWLAN:TFRequency:ATGRam:COLor[:SCALe] :OFFSet(?)	Sets the minimum color-axis value of the amplitude transfogram.
:DISPlay:SWLAN:TFRequency:ATGRam:COLor[:SCALe] :RANGe(?)	Sets the color-axis scale of the amplitude transfogram.
:DISPlay:SWLAN:TFRequency:ATGRam:X[:SCALe] :OFFSet(?)	Sets the minimum horizontal value of the amplitude transfogram.
:DISPlay:SWLAN:TFRequency:ATGRam:X[:SCALe] :RANGe(?)	Sets the horizontal full-scale of the amplitude transfogram.
:DISPlay:SWLAN:TFRequency:ATGRam:Y[:SCALe] :OFFSet(?)	Sets the minimum vertical value of the amplitude transfogram.
:DISPlay:SWLAN:TFRequency:ATGRam:Y[:SCALe] :PLINe(?)	Sets the vertical scale of the amplitude transfogram.

Table 2- 16: :DISPlay commands (Option) (Cont.)

Header	Description
:DISPlay:SWLAN:TFRequency:DGRam:COLor[:SCALe]:OFFSet(?)	Sets the minimum color-axis value of the delayogram.
:DISPlay:SWLAN:TFRequency:DGRam:COLor[:SCALe]:RANGe(?)	Sets the color-axis scale of the delayogram.
:DISPlay:SWLAN:TFRequency:DGRam:X[:SCALe]:OFFSet(?)	Sets the minimum horizontal value of the delayogram.
:DISPlay:SWLAN:TFRequency:DGRam:X[:SCALe]:RANGe(?)	Sets the horizontal full-scale of the delayogram.
:DISPlay:SWLAN:TFRequency:DGRam:Y[:SCALe]:OFFSet(?)	Sets the minimum vertical value of the delayogram.
:DISPlay:SWLAN:TFRequency:DGRam:Y[:SCALe]:PLINe(?)	Sets the vertical scale of the delayogram.
:DISPlay:SWLAN:TFRequency:PTGRam:COLor[:SCALe]:OFFSet(?)	Sets the minimum color-axis value of the phase transfogram.
:DISPlay:SWLAN:TFRequency:PTGRam:COLor[:SCALe]:RANGe(?)	Sets the color-axis scale of the phase transfogram.
:DISPlay:SWLAN:TFRequency:PTGRam:X[:SCALe]:OFFSet(?)	Sets the minimum horizontal value of the phase transfogram.
:DISPlay:SWLAN:TFRequency:PTGRam:X[:SCALe]:RANGe(?)	Sets the horizontal full-scale of the phase transfogram.
:DISPlay:SWLAN:TFRequency:PTGRam:Y[:SCALe]:OFFSet(?)	Sets the minimum vertical value of the phase transfogram.
:DISPlay:SWLAN:TFRequency:PTGRam:Y[:SCALe]:PLINe(?)	Sets the vertical scale of the phase transfogram.
:DISPlay:WLAN:DDEMod subgroup	IEEE802.11a/b/g modulation analysis related
:DISPlay:WLAN:DDEMod:MVlew:FORMat(?)	Selects the display format in the OFDM linearity measurement.
:DISPlay:WLAN:DDEMod:MVlew:MCONtent(?)	Selects the measurement content of the main view.
:DISPlay:WLAN:DDEMod:MVlew:RADix(?)	Selects the base of symbols in the main view.
:DISPlay:WLAN:DDEMod:MVlew:X[:SCALe]:OFFSet(?)	Sets the minimum value of the horizontal axis in the main view.
:DISPlay:WLAN:DDEMod:MVlew:X[:SCALe]:PDIVision(?)	Sets the horizontal scale (time per division) in the time domain display.
:DISPlay:WLAN:DDEMod:MVlew:X[:SCALe]:RANGe(?)	Sets the full-scale value of the horizontal axis in the main view.
:DISPlay:WLAN:DDEMod:MVlew:Y[:SCALe]:FIT	Runs the auto-scale on the main view.
:DISPlay:WLAN:DDEMod:MVlew:Y[:SCALe]:FULL	Sets the vertical axis in the main view to the default full-scale value.
:DISPlay:WLAN:DDEMod:MVlew:Y[:SCALe]:OFFSet(?)	Sets the minimum value of the vertical axis in the main view.
:DISPlay:WLAN:DDEMod:MVlew:Y[:SCALe]:PDIVision(?)	Sets the vertical scale (per division) in the time domain display.
:DISPlay:WLAN:DDEMod:MVlew:Y[:SCALe]:RANGe(?)	Sets the full-scale value of the vertical axis in the main view.
:DISPlay:WLAN:DDEMod:SVlew:FORMat(?)	Selects the display format of the subview.
:DISPlay:WLAN:DDEMod:SVlew:MCONtent(?)	Selects the measurement content of the subview.

Table 2- 16: :DISPlay commands (Option) (Cont.)

Header	Description
:DISPlay:WLAN:DDEMod:SVIew:RADix(?)	Selects the base of symbols in the subview.
:DISPlay:WLAN:DDEMod:SVIew:X[:SCALe]:OFFSet(?)	Sets the minimum value of the horizontal axis in the subview.
:DISPlay:WLAN:DDEMod:SVIew:X[:SCALe]:PDIVision(?)	Sets the horizontal scale (time per division) in the time domain display.
:DISPlay:WLAN:DDEMod:SVIew:X[:SCALe]:RANGe(?)	Sets the full-scale value of the horizontal axis in the subview.
:DISPlay:WLAN:DDEMod:SVIew:Y[:SCALe]:FIT	Runs the auto-scale on the subview.
:DISPlay:WLAN:DDEMod:SVIew:Y[:SCALe]:FULL	Sets the vertical axis in the subview to the default full-scale value.
:DISPlay:WLAN:DDEMod:SVIew:Y[:SCALe]:OFFSet(?)	Sets the minimum value of the vertical axis in the subview.
:DISPlay:WLAN:DDEMod:SVIew:Y[:SCALe]:PDIVision(?)	Sets the vertical scale (per division) in the time domain display.
:DISPlay:WLAN:DDEMod:SVIew:Y[:SCALe]:RANGe(?)	Sets the full-scale value of the vertical axis in the subview.
:DISPlay:WLAN:SPECTrum subgroup	Spectrum view related in the IEEE802.11a/b/g analysis
:DISPlay:WLAN:SPECTrum:X[:SCALe]:OFFSet(?)	Sets the minimum value of the horizontal axis in the spectrum view.
:DISPlay:WLAN:SPECTrum:X[:SCALe]:PDIVision(?)	Sets the horizontal scale (per division) in the spectrum view.
:DISPlay:WLAN:SPECTrum:Y[:SCALe]:FIT	Runs the auto-scale on the spectrum view.
:DISPlay:WLAN:SPECTrum:Y[:SCALe]:FULL	Sets the vertical axis to the default full-scale value in the spectrum view.
:DISPlay:WLAN:SPECTrum:Y[:SCALe]:OFFSet(?)	Sets the minimum value of the vertical axis in the spectrum view.
:DISPlay:WLAN:SPECTrum:Y[:SCALe]:PDIVision(?)	Sets the vertical scale (per division) in the spectrum view.
Option 40 3GPP-R6 analysis related	
:DISPlay:DLR6_3GPP subgroup	Related to modulation analysis for 3GPP-R6 downlink
:DISPlay:DLR6_3GPP:AVIew:CCODE(?)	Sets the channelization code to position the marker.
:DISPlay:DLR6_3GPP:AVIew:MSLot:HEAD(?)	Sets the number of the head of the time slot to be displayed.
:DISPlay:DLR6_3GPP:AVIew:MSLot[:STATe](?)	Determines whether to display the multiple or the single slot.
:DISPlay:DLR6_3GPP:AVIew:RESult:AGSCOpe(?)	Determines whether to show the Absolute Grant Scope in the table.
:DISPlay:DLR6_3GPP:AVIew:RESult:AGValue(?)	Determines whether to show Absolute Grant Value in the table.
:DISPlay:DLR6_3GPP:AVIew:RESult:ANACK(?)	Determines whether to show ACK/NACK in the table.
:DISPlay:DLR6_3GPP:AVIew:RESult:RGRant(?)	Determines whether to show Relative Grant Value in the table.
:DISPlay:DLR6_3GPP:AVIew:RESult:SCGRoup(?)	Determines whether to show Scrambling Code Group in the table.
:DISPlay:DLR6_3GPP:AVIew:RESult:SCNumber(?)	Determines whether to show Scrambling Code Number in the table.
:DISPlay:DLR6_3GPP:AVIew:RESult:SSCH(?)	Determines whether to show S-SCH in the table.
:DISPlay:DLR6_3GPP:AVIew:SRATe(?)	Selects the symbol rate for downlink analysis.
:DISPlay:DLR6_3GPP:AVIew:SSCHpart(?)	Determines whether to show SCH.
:DISPlay:DLR6_3GPP:AVIew:TSLot(?)	Selects the time slot to display.
:DISPlay:DLR6_3GPP:MVIew:[SVIew:COLor[:SCALe] :OFFSet(?)	Sets the minimum color-axis value (bottom) in the main view or subview.
:DISPlay:DLR6_3GPP:MVIew:[SVIew:COLor[:SCALe] :RANGe(?)	Sets the color-axis full scale in the main view or subview.

Table 2- 16: :DISPlay commands (Option) (Cont.)

Header	Description
:DISPlay:DLR6_3GPP:MVlew: SVlew:FORMat(?)	Selects the display format in the main view or subview.
:DISPlay:DLR6_3GPP:MVlew: SVlew:RADix(?)	Selects the base of symbols in the main view or subview.
:DISPlay:DLR6_3GPP:MVlew: SVlew:X[:SCALE]:OFFSet(?)	Sets the minimum horizontal value (left edge) in the view.
:DISPlay:DLR6_3GPP:MVlew: SVlew:X[:SCALE]:RANGE(?)	Sets the horizontal full scale in the main view or subview.
:DISPlay:DLR6_3GPP:MVlew: SVlew:Y[:SCALE]:FIT	Runs auto-scale in the main view or subview.
:DISPlay:DLR6_3GPP:MVlew: SVlew:Y[:SCALE]:FULL	Sets the vertical axis to the default full scale.
:DISPlay:DLR6_3GPP:MVlew: SVlew:Y[:SCALE]:OFFSet(?)	Sets the minimum vertical value (bottom) in the main view or subview.
:DISPlay:DLR6_3GPP:MVlew: SVlew:Y[:SCALE]:PUNit(?)	Selects the unit of the vertical axis in the main view or subview.
:DISPlay:DLR6_3GPP:MVlew: SVlew:Y[:SCALE]:RANGE(?)	Sets the vertical full scale in the main view or subview.
:DISPlay:ULR6_3GPP subgroup	Related to modulation analysis for 3GPP-R6 uplink
:DISPlay:ULR6_3GPP:AVlew:CCODE(?)	Sets the channelization code to position the marker.
:DISPlay:ULR6_3GPP:AVlew:CNUMBER(?)	Sets the channelization code to position the marker.
:DISPlay:ULR6_3GPP:AVlew:FORMat(?)	Selects the view format.
:DISPlay:ULR6_3GPP:AVlew:IQRanch(?)	Selects the I/Q branch.
:DISPlay:ULR6_3GPP:AVlew:RESult:ANACK(?)	Determines whether to show ACK/NACK in the table.
:DISPlay:ULR6_3GPP:AVlew:RESult:CQI(?)	Determines whether to show CQI in the table.
:DISPlay:ULR6_3GPP:AVlew:RESult:ETFCi(?)	Determines whether to show E-TFCI in the table.
:DISPlay:ULR6_3GPP:AVlew:RESult:HAPPy(?)	Determines whether to show Happy bit value in the table.
:DISPlay:ULR6_3GPP:AVlew:RESult:OFFSet(?)	Determines whether to show Subframe to Time-slot Offset in the table.
:DISPlay:ULR6_3GPP:AVlew:RESult:PREamble(?)	Determines whether to show preamble in the table.
:DISPlay:ULR6_3GPP:AVlew:RESult:RSN(?)	Determines whether to show RSN in the table.
:DISPlay:ULR6_3GPP:AVlew:RESult:SIGNature(?)	Determines whether to show Signature Number in the table.
:DISPlay:ULR6_3GPP:AVlew:RESult:TPC(?)	Determines whether to show TPC in the table.
:DISPlay:ULR6_3GPP:AVlew:SRATE(?)	Selects the symbol rate for downlink analysis.
:DISPlay:ULR6_3GPP:AVlew:TSLOT(?)	Selects the time slot to display.
:DISPlay:ULR6_3GPP:MVlew: SVlew:COLor[:SCALE]:OFFSet(?)	Sets the minimum color-axis value (bottom) in the main view or subview.
:DISPlay:ULR6_3GPP:MVlew: SVlew:COLor[:SCALE]:RANGE(?)	Sets the color-axis full scale in the main view or subview.
:DISPlay:ULR6_3GPP:MVlew: SVlew:FORMat(?)	Selects the display format in the main view or subview.
:DISPlay:ULR6_3GPP:MVlew: SVlew:NUMBER(?)	Selects the number of graphs displayed in the main view or subview.
:DISPlay:ULR6_3GPP:MVlew: SVlew:PREference(?)	Selects the power reference in the main view or subview.

Table 2-16: :DISPlay commands (Option) (Cont.)

Header	Description
:DISPlay:ULR6_3GPP:MView:[SVIew:RADix(?)	Selects the base of symbols in the main view or subview.
:DISPlay:ULR6_3GPP:MView:[SVIew:X[:SCALE]:LINE(?)	Sets the position of the horizontal line in the gain ratio measurement.
:DISPlay:ULR6_3GPP:MView:[SVIew:X[:SCALE]:OFFSet(?)	Sets the minimum horizontal value (left edge) in the view.
:DISPlay:ULR6_3GPP:MView:[SVIew:X[:SCALE]:RANGe(?)	Sets the horizontal full scale in the main view or subview.
:DISPlay:ULR6_3GPP:MView:[SVIew:Y[:SCALE]:FIT	Runs auto-scale in the main view or subview.
:DISPlay:ULR6_3GPP:MView:[SVIew:Y[:SCALE]:FULL	Sets the vertical axis to the default full scale.
:DISPlay:ULR6_3GPP:MView:[SVIew:Y[:SCALE]:OFFSet(?)	Sets the minimum vertical value (bottom) in the main view or subview.
:DISPlay:ULR6_3GPP:MView:[SVIew:Y[:SCALE]:PUNit(?)	Selects the unit of the vertical axis in the main view or subview.
:DISPlay:ULR6_3GPP:MView:[SVIew:Y[:SCALE]:RANGe(?)	Sets the vertical full scale in the main view or subview.

:FETCh Commands

The :FETCh commands retrieve the measurements from the data taken by the latest INITiate command.

If you want to perform a FETCh operation on fresh data, use the :READ commands, which acquire a new input signal and fetch the measurement results from that data.

Table 2-17: :FETCh commands

Header	Description
:FETCh:ADEMod:AM?	Returns the AM signal analysis results in time series.
:FETCh:ADEMod:AM:RESult?	Returns the AM signal analysis results.
:FETCh:ADEMod:FM?	Returns the FM signal analysis results in time series.
:FETCh:ADEMod:FM:RESult?	Returns the FM signal analysis results.
:FETCh:ADEMod:PM?	Returns the PM signal analysis results in time series.
:FETCh:ADEMod:PSPectrum?	Returns the spectrum data of the pulse spectrum measurement.
:FETCh:CCDF?	Returns the CCDF measurement results.
:FETCh:DISTRibution:CCDF?	Returns the CCDF trace data.
:FETCh:OVIew?	Returns the maximum and minimum of waveform on the overview.
:FETCh:PULSe?	Returns the result of the pulse characteristics analysis.
:FETCh:PULSe:SPECTrum?	Returns the spectrum data of the frequency domain measurement.

Table 2- 17: :FETCh commands (Cont.)

Header	Description
:FETCh:PULSe:TAMPlitude?	Returns the time domain amplitude data.
:FETCh:PULSe:TFRequency?	Returns the frequency deviation measurement results.
:FETCh:SPECTrum?	Returns spectrum waveform data.
:FETCh:SPECTrum:ACPowEr?	Returns the ACPR measurement results.
:FETCh:SPECTrum:CFRequency?	Returns the carrier frequency measurement results.
:FETCh:SPECTrum:CHPowEr?	Returns the channel power measurement results.
:FETCh:SPECTrum:CNRatio?	Returns the C/N measurement results.
:FETCh:SPECTrum:EBWidTh?	Returns the emission bandwidth measurement results.
:FETCh:SPECTrum:OBWidTh?	Returns the OBW measurement results.
:FETCh:SPECTrum:SPURious?	Returns the spurious signal measurement results.
:FETCh:TRANsient:FVTime?	Returns the frequency versus time measurement results.
:FETCh:TRANsient:IQVTime?	Returns the I/Q level versus time measurement results.
:FETCh:TRANsient:PVTime?	Returns the power versus time measurement results.

:FETCh Commands (Option)

Table 2-18 shows the :FETCh commands for optional analysis software.

Table 2- 18: :FETCh commands (Option)

Header	Description
Option 21 Advanced measurement suite related	
:FETCh:DDEMod subgroup	Digital modulation analysis related
:FETCh:DDEMod?	Returns the results of the digital modulation analysis.
:FETCh:RFID subgroup	RFID analysis related
:FETCh:RFID?	Returns the measurement result of the RFID analysis.
:FETCh:RFID:ACPowEr?	Returns the results of the ACPR measurement.
:FETCh:RFID:SPURious?	Returns the results of the spurious signal measurement.
:FETCh:RFID:SPECTrum:ACPowEr?	Returns spectrum waveform data of the ACPR measurement.
:FETCh:RFID:SPECTrum:SPURious?	Returns spectrum waveform data of the spurious measurement.
:FETCh:SSource subgroup	Signal source analysis related
:FETCh:SSource?	Returns the measurement result in the signal source analysis.
:FETCh:SSource:CNVFrequency?	Returns measurement data of the C/N versus offset frequency.
:FETCh:SSource:CNVTime?	Returns waveform data of the C/N versus time.
:FETCh:SSource:IPNVtime?	Returns waveform data of the integrated phase noise versus time.

Table 2-18: :FETCh commands (Option) (Cont.)

Header	Description
:FETCh:SSource:RJVTime?	Returns waveform data of the random jitter versus time.
:FETCh:SSource:SPECTrum?	Returns the spectrum data.
:FETCh:SSource:TRANsient:FVTime?	Returns the frequency versus time measurement. results.
Option 23 W-CDMA uplink analysis related	
:FETCh:AC3Gpp:ACLR?	Returns the W-CDMA ACLR measurement results.
:FETCh:UL3Gpp?	Returns the W-CDMA uplink analysis measurement results.
Option 24 GSM/EDGE analysis related	
:FETCh:GSMedge:MACCuracy?	Returns the GSM/EDGE modulation accuracy measurement results.
:FETCh:GSMedge:MCPower?	Returns the GSM/EDGE mean carrier power measurement results.
:FETCh:GSMedge:MODulation?	Returns the GSM/EDGE modulation spectrum measurement results.
:FETCh:GSMedge:PVTime?	Returns the GSM/EDGE power versus time measurement results.
:FETCh:GSMedge:SPECTrum:MODulation?	Returns waveform data in the modulation spectrum measurement.
:FETCh:GSMedge:SPECTrum:SWITching?	Returns waveform data in the switching spectrum measurement.
:FETCh:GSMedge:SPURious?	Returns the GSM/EDGE spurious measurement results.
:FETCh:GSMedge:SWITching?	Returns the GSM/EDGE switching spectrum measurement results.
:FETCh:GSMedge:TAMPlitude:MCPower?	Returns the time amplitude for the mean carrier power measurement.
:FETCh:GSMedge:TAMPlitude:PVTime?	Returns the time amplitude for the power versus time measurement.
:FETCh:GSMedge:TSCode?	Returns the training sequence code in the GSM/EDGE analysis.
Option 25 cdma2000 analysis related (:Standard = :FLCDMA2K :RLCDMA2K)	
:FETCh:Standard:ACPower?	Returns the ACPR measurement results.
:FETCh:Standard:CCDF?	Returns the CCDF measurement results.
:FETCh:Standard:CDPower?	Returns the code domain power measurement results.
:FETCh:Standard:CHPower?	Returns the channel power measurement results.
:FETCh:Standard:DISTRibution:CCDF?	Returns the distribution data of the CCDF measurement.
:FETCh:Standard:IM?	Returns the intermodulation measurement results.
:FETCh:Standard:MACCuracy?	Returns the modulation accuracy measurement results.
:FETCh:Standard:OBWidth?	Returns the occupied bandwidth measurement results.
:FETCh:Standard:PCCHannel?	Returns the pilot-to-code channel measurement results.
:FETCh:RLCDMA2K:PVTime?	Returns the gated output power measurement results.
:FETCh:Standard:SEMAsk?	Returns the spectrum emission mask measurement results.
:FETCh:Standard:SPECTrum:ACPower?	Returns spectrum waveform data of the ACPR measurement.
:FETCh:Standard:SPECTrum:CHPower?	Returns spectrum waveform data of the channel power measurement.
:FETCh:Standard:SPECTrum:IM?	Returns spectrum waveform data of the intermodulation measurement.
:FETCh:Standard:SPECTrum:OBWidth?	Returns spectrum waveform data of the OBW measurement.
:FETCh:RLCDMA2K:TAMPlitude:PVTime?	Returns the time amplitude for the gated output power measurement.

Table 2- 18: :FETCh commands (Option) (Cont.)

Header	Description
Option 26 1xEV-DO analysis related (:Standard = :FL1XEVD0 :RL1XEVD0)	
:FETCh:Standard:ACPower?	Returns the ACPR measurement results.
:FETCh:Standard:CCDF?	Returns the CCDF measurement results.
:FETCh:Standard:CDPower?	Returns the code domain power measurement results.
:FETCh:Standard:CHPower?	Returns the channel power measurement results.
:FETCh:Standard:DISTRibution:CCDF?	Returns the distribution data of the CCDF measurement.
:FETCh:Standard:IM?	Returns the intermodulation measurement results.
:FETCh:Standard:MACCuracy?	Returns the modulation accuracy measurement results.
:FETCh:Standard:OBWidth?	Returns the occupied bandwidth measurement results.
:FETCh:Standard:PCCHannel?	Returns the pilot-to-code channel measurement results.
:FETCh:FL1XEVD0:PVTime?	Returns the gated output power measurement results.
:FETCh:Standard:SEMask?	Returns the spectrum emission mask measurement results.
:FETCh:Standard:SPECTrum:ACPower?	Returns spectrum waveform data of the ACPR measurement.
:FETCh:Standard:SPECTrum:CHPower?	Returns spectrum waveform data of the channel power measurement.
:FETCh:Standard:SPECTrum:IM?	Returns spectrum waveform data of the intermodulation measurement.
:FETCh:Standard:SPECTrum:OBWidth?	Returns spectrum waveform data of the OBW measurement.
:FETCh:FL1XEVD0:TAMplitude:PVTime?	Returns the time amplitude for the gated output power measurement.
Option 27 3GPP-R5 analysis related (:Standard = SADLR5_3GPP :SAULR5_3GPP)	
:FETCh:DLR5_3GPP subgroup	3GPP-R5 downlink analysis related
:FETCh:DLR5_3GPP?	Returns measurement results of the downlink modulation analysis.
:FETCh:Standard subgroup	3GPP-R5 spectrum analysis related
:FETCh:Standard:ACLR?	Returns the ACLR measurement results.
:FETCh:Standard:CFRequency?	Returns the carrier frequency measurement results.
:FETCh:Standard:CHPower?	Returns the channel power measurement results.
:FETCh:Standard:EBWidth?	Returns the EBW measurement results.
:FETCh:SADLR5_3GPP:MCAClr?	Returns the multi-carrier ACLR measurement results.
:FETCh:Standard:OBWidth?	Returns the OBW measurement results.
:FETCh:Standard:SEMask?	Returns the spectrum emission mask measurement results.
:FETCh:Standard:SPECTrum:ACLR?	Returns spectrum waveform data of the ACLR measurement.
:FETCh:Standard:SPECTrum:CFRequency?	Returns spectrum waveform data of the carrier frequency measurement.
:FETCh:Standard:SPECTrum:CHPower?	Returns spectrum waveform data of the channel power measurement.
:FETCh:Standard:SPECTrum:EBWidth?	Returns spectrum waveform data of the EBW measurement.
:FETCh:SADLR5_3GPP:SPECTrum:MCAClr?	Returns spectrum waveform data of multi-carrier ACLR measurement.
:FETCh:Standard:SPECTrum:OBWidth?	Returns spectrum waveform data of the OBW measurement.
:FETCh:Standard:SPECTrum:SEMask?	Returns waveform data of the spectrum emission mask measurement.

Table 2-18: :FETCh commands (Option) (Cont.)

Header	Description
:FETCh:ULR5_3GPP subgroup	3GPP-R5 uplink analysis related
:FETCh:ULR5_3GPP?	Returns measurement results of the uplink modulation analysis.
Option 28 TD-SCDMA analysis related	
:FETCh:TD_SCDMA:ACLR?	Returns the adjacent channel leakage power ratio measurement results.
:FETCh:TD_SCDMA:CDPower?	Returns the code domain power measurement results.
:FETCh:TD_SCDMA:CHPower?	Returns the channel power measurement results.
:FETCh:TD_SCDMA:IM?	Returns the intermodulation measurement results.
:FETCh:TD_SCDMA:MACCuracy?	Returns the modulation accuracy measurement results.
:FETCh:TD_SCDMA:OBWidth?	Returns the occupied bandwidth measurement results.
:FETCh:TD_SCDMA:SEMAsk?	Returns the spectrum emission mask measurement results.
:FETCh:TD_SCDMA:SFSummary?	Returns the subframe summary measurement results.
:FETCh:TD_SCDMA:STABle?	Returns the symbol table measurement results.
:FETCh:TD_SCDMA:TOOMask?	Returns the results of the transmit on/off mask measurement.
:FETCh:TD_SCDMA:TSSummary?	Returns the timeslot summary measurement results.
:FETCh:TD_SCDMA:SPECTrum:ACLR?	Returns spectrum waveform data of the ACLR measurement.
:FETCh:TD_SCDMA:SPECTrum:CHPower?	Returns spectrum waveform data of the channel power measurement.
:FETCh:TD_SCDMA:SPECTrum:IM?	Returns spectrum waveform data of the intermodulation measurement.
:FETCh:TD_SCDMA:SPECTrum:OBWidth?	Returns spectrum waveform data of the OBW measurement.
:FETCh:TD_SCDMA:SPECTrum:SEMAsk?	Returns waveform data of the spectrum emission mask measurement.
:FETCh:TD_SCDMA:TAMPlitude:SFSummary?	Returns time domain amplitude of the subframe summary measurement.
:FETCh:TD_SCDMA:TAMPlitude:TOOMask?	Returns amplitude data of the transmit on/off mask measurement.
:FETCh:TD_SCDMA:TAMPlitude:TSSummary?	Returns amplitude data of the timeslot summary measurement.
Option 29 WLAN analysis related	
:FETCh:M2WLAN subgroup	IEEE802.11n MIMO (2x2) analysis related
:FETCh:M2WLAN?	Returns the results of 802.11n MIMO (2x2) modulation analysis.
:FETCh:SWLAN subgroup	IEEE802.11n (nx1) analysis related
:FETCh:SWLAN?	Returns the results of 802.11n (nx1) modulation analysis.
:FETCh:SWLAN:SMASK?	Returns the result of the spectrum mask measurement.
:FETCh:SWLAN:SPECTrum:SMASK?	Returns spectrum waveform data of the spectrum mask measurement.
:FETCh:WLAN subgroup	IEEE802.11a/b/g analysis related
:FETCh:WLAN?	Returns the results of the WLAN a/b/g modulation analysis.
:FETCh:WLAN:POWer:TPOWer?	Returns spectrum waveform data of the transmit power measurement.
:FETCh:WLAN:SMASK?	Returns the result of the spectrum mask measurement.
:FETCh:WLAN:SPECTrum:SMASK?	Returns spectrum waveform data of the spectrum mask measurement.
:FETCh:WLAN:TPOWer?	Returns the results of the transmit power measurement.

Table 2-18: :FETCh commands (Option) (Cont.)

Header	Description
Option 40 3GPP-R6 analysis related	
:FETCh:DLR6_3GPP subgroup	3GPP-R6 downlink analysis related
:FETCh:DLR6_3GPP?	Returns measurement results of the downlink modulation analysis.
:FETCh:ULR6_3GPP subgroup	3GPP-R6 uplink analysis related
:FETCh:ULR6_3GPP?	Returns measurement results of the uplink modulation analysis.

:FORMat Commands

Define the data output format.

Table 2-19: :FORMat commands

Header	Description
:FORMat:BORDER(?)	Selects the byte order of output data.
:FORMat[:DATA](?)	Selects the data format for output.

:HCOPy Commands

Control hardcopy of the screen.

Table 2-20: :HCOPy commands

Header	Description
:HCOPy:BACKground	Selects the hardcopy background color.
:HCOPy:DESTination	Selects the hardcopy output destination.
:HCOPy[:IMMEDIATE]	Outputs the hardcopy to the specified printer.

:INITiate Commands

Control data acquisition.

Table 2-21: :INITiate commands

Header	Description
:INITiate:CONTInuous(?)	Determines whether to acquire data continuously.
:INITiate[:IMMediate]	Starts data acquisition.
:INITiate:REStart	Restarts data acquisition.

:INPut Commands

Control the characteristics of the signal input.

Table 2-22: :INPut commands

Header	Description
:INPut:ALEVel	Adjusts amplitude automatically for the best system performance.
:INPut:ATTenuation(?)	Sets the input attenuation.
:INPut:ATTenuation:AUTO(?)	Determines whether to set the input attenuation automatically.
:INPut:MIXer(?)	Sets the mixer level.
:INPut:MLEVel(?)	Sets the reference level.

:INSTRument Commands

Sets the measurement mode for the analyzer.

Table 2-23: :INSTRument commands

Header	Description
:INSTRument:CATalog?	Queries all the measurement modes that the analyzer has.
:INSTRument[:SElect]	Selects the measurement mode.

:MMEMory Commands

Manipulates files residing on the internal hard disk or external mass storage.

Table 2-24: :MMEMory commands

Header	Description
:MMEMory:COpy	Copies the contents of a file to another.
:MMEMory:DELeTe	Deletes a file.
:MMEMory:LOAD:CORRection	Loads the correction table from a file.
:MMEMory:LOAD:IQT	Loads the IQ data from a file.
:MMEMory:LOAD:LIMit (Option 25, 26, 27, and 28)	Loads the limit from the specified file.
:MMEMory:LOAD:RX<x> (Option 29)	Loads the waveform data received by the antenna 1 or 2.
:MMEMory:LOAD:STATe	Loads the analyzer settings from a file.
:MMEMory:LOAD:TRACe<x>	Loads trace data from a file.
:MMEMory:NAME(?)	Specifies the file name for hard copy output.
:MMEMory:STORe:ACPower (Option 21)	Stores the ACPR measurement results in a file in the RFID analysis.
:MMEMory:STORe:CORRection	Stores an amplitude correction table in a file.
:MMEMory:STORe:IQT	Stores IQ data in a file.
:MMEMory:STORe:LIMit (Option 25, 26, 27, and 28)	Stores the limit in the specified file.
:MMEMory:STORe:PULSe	Stores the pulse measurement results in a file.
:MMEMory:STORe:RESult:ALLData (Option 29)	Stores Trace 1 and 2 to a file in all combinations of Tx and Rx antennas.
:MMEMory:STORe:RESult:BOTHtrace (Option 29)	Stores Trace 1 and 2 in the main view to two files.
:MMEMory:STORe:RESult:NPACkets[:NUMBer]?((Option 29)	Sets the number of packets to save.
:MMEMory:STORe:RESult:ONETrace (Option 29)	Stores Trace 1 in the main view to a file.
:MMEMory:STORe:RESult:POFFset[:NUMBer]?((Option 29)	Sets the first packet number (packet offset) to store the trace data.
:MMEMory:STORe:RESult:TRACe (Option 29)	Stores the trace data displayed in the main view to a file.
:MMEMory:STORe:RESult:TWOTrace (Option 29)	Stores Trace 2 in the main view to a file.
:MMEMory:STORe:RESult:ITEM(?) (Option 40)	Selects the measurement item to store.
:MMEMory:STORe:RESult:MCONtent(?) (Option 40)	Selects the measurement content in the symbol EVM measurement.
:MMEMory:STORe:RESult[:SElect] (Option 40)	Stores the measurement results in the specific file.
:MMEMory:STORe:RESult:TSLot:OFFSet(?) (Option 40)	Sets the first time-slot for storing the measurement results.
:MMEMory:STORe:RESult:TSLot:NUMBer(?) (Option 40)	Sets the number of time slots for storing the measurement results.
:MMEMory:STORe:STABLe (Option 21, 23, 25, 26, 27, 28, 29, and 40)	Stores a symbol table in a file.
:MMEMory:STORe:STATe	Stores the analyzer settings in a file.
:MMEMory:STORe:TRACe<x>	Stores trace data in a file.

:OUTPut Commands

Control the characteristics of the analyzer's output port.

Table 2-25: :PROGram commands

Header	Description
:OUTPut:IQ[:STATe](?) (Option 05 only)	Determines whether to enable the digital IQ data output.

:PROGram Commands

Control macro programs.

Table 2-26: :PROGram commands

Header	Description
:PROGram:CATalog?	Queries the list of macro programs.
:PROGram[:SELected]:DELeTe[:SELected]	Deletes a macro program.
:PROGram[:SELected]:EXECute	Runs a macro program.
:PROGram[:SELected]:NAME(?)	Specifies a macro program.
:PROGram:NUMBer(?)	Sets numeric variables for a program.
:PROGram:STRing(?)	Sets character variables for a program.

:READ Commands

The :READ commands acquire an input signal once in the single mode and obtain the measurement results from that data.

If you want to fetch the measurement results from the data currently residing in the memory without acquiring the input signal, use the :FETCh commands.

Table 2-27: :READ commands

Header	Description
:READ:ADEMod:AM?	Returns the AM signal analysis results in time series.
:READ:ADEMod:AM:RESult?	Returns the AM signal analysis results.
:READ:ADEMod:FM?	Returns the FM signal analysis results in time series.
:READ:ADEMod:FM:RESult?	Returns the FM signal analysis results.
:READ:ADEMod:PM?	Returns the PM signal analysis results in time series.
:READ:ADEMod:PSPectrum?	Returns the spectrum data of the pulse spectrum measurement.

Table 2-27: :READ commands (Cont.)

Header	Description
:READ:CCDF?	Returns the CCDF measurement results.
:READ:DISTribution:CCDF?	Returns the CCDF trace data.
:READ:OView?	Returns the maximum and minimum of waveform on the overview.
:READ:PULSe?	Returns the result of the pulse characteristics analysis.
:READ:PULSe:SPECTrum?	Returns the spectrum data of the frequency domain measurement.
:READ:PULSe:TAMPlitude?	Returns the time domain amplitude data.
:READ:PULSe:TFRrequency?	Returns the frequency deviation measurement results.
:READ:SPECTrum?	Returns spectrum waveform data.
:READ:SPECTrum:ACPower?	Returns the ACPR measurement results.
:READ:SPECTrum:CFrequency?	Returns the carrier frequency measurement results.
:READ:SPECTrum:CHPower?	Returns the channel power measurement results.
:READ:SPECTrum:CNRatio?	Returns the C/N measurement results.
:READ:SPECTrum:EBWidth?	Returns the emission bandwidth measurement results.
:READ:SPECTrum:OBWidth?	Returns the OBW measurement results.
:READ:SPECTrum:SPURious?	Returns the spurious signal measurement results.
:READ:TRANSient:FVTime?	Returns the frequency versus time measurement results.
:READ:TRANSient:IQVTime?	Returns the I/Q level versus time measurement results.
:READ:TRANSient:PVTime?	Returns the power versus time measurement results.

:READ Commands (Option)

Table 2-18 shows the :READ commands for optional analysis software.

Table 2-28: :READ commands (Option)

Header	Description
Option 21 Advanced measurement suite related	
:READ:DDEMod subgroup	Digital modulation analysis related
:READ:DDEMod?	Returns the results of the digital modulation analysis.
:READ:RFID subgroup	RFID analysis related
:READ:RFID:ACPower?	Returns the results of the ACPR measurement.
:READ:RFID:SPURious?	Returns the results of the spurious signal measurement.
:READ:RFID:SPECTrum:ACPower?	Returns spectrum waveform data of the ACPR measurement.
:READ:RFID:SPECTrum:SPURious?	Returns spectrum waveform data of the spurious measurement.

Table 2-28: :READ commands (Option) (Cont.)

Header	Description
:READ:SSource subgroup	Signal source analysis related.
:READ:SSource?	Returns the results of the signal source analysis.
:READ:SSource:SPECTrum?	Returns the spectrum data.
:READ:SSource:TRANsient:FVTime?	Returns the results of the frequency versus time measurement.
Option 23 W-CDMA uplink analysis related	
:READ:AC3Gpp:ACLR?	Returns the W-CDMA ACLR measurement results.
Option 24 GSM/EDGE analysis related	
:READ:GSMedge:MACCuracy?	Returns the GSM/EDGE modulation accuracy measurement results.
:READ:GSMedge:MCPower?	Returns the GSM/EDGE mean carrier power measurement results.
:READ:GSMedge:MODulation?	Returns the GSM/EDGE modulation spectrum measurement results.
:READ:GSMedge:PVTime?	Returns the GSM/EDGE power versus time measurement results.
:READ:GSMedge:SPECTrum:MODulation?	Returns waveform data in the modulation spectrum measurement.
:READ:GSMedge:SPECTrum:SWITching?	Returns waveform data in the switching spectrum measurement.
:READ:GSMedge:SPURious?	Returns the GSM/EDGE spurious measurement results.
:READ:GSMedge:SWITching?	Returns the GSM/EDGE switching spectrum measurement results.
:READ:GSMedge:TAMPlitude:MCPower?	Returns the time amplitude for the mean carrier power measurement.
:READ:GSMedge:TAMPlitude:PVTime?	Returns the time amplitude for the power versus time measurement.
Option 25 cdma2000 analysis related (:Standard = :FLCDMA2K :RLCDMA2K)	
:READ:Standard:ACPower?	Returns the ACPR measurement results.
:READ:Standard:CCDF?	Returns the CCDF measurement results.
:READ:Standard:CHPower?	Returns the channel power measurement results.
:READ:Standard:DISTRibution:CCDF?	Returns the distribution data of the CCDF measurement.
:READ:Standard:IM?	Returns the intermodulation measurement results.
:READ:Standard:OBWidth?	Returns the occupied bandwidth measurement results.
:READ:RLCDMA2K:PVTime?	Returns the gated output power measurement results.
:READ:Standard:SEMAsk?	Returns the spectrum emission mask measurement results.
:READ:Standard:SPECTrum:ACPower?	Returns spectrum waveform data of the ACPR measurement.
:READ:Standard:SPECTrum:CHPower?	Returns spectrum waveform data of the channel power measurement.
:READ:Standard:SPECTrum:IM?	Returns spectrum waveform data of the intermodulation measurement.
:READ:Standard:SPECTrum:OBWidth?	Returns spectrum waveform data of the OBW measurement.
:READ:RLCDMA2K:TAMPlitude:PVTime?	Returns the time amplitude for the gated output power measurement.
Option 26 1xEV-DO analysis related (:Standard = :FL1XEVD0 :RL1XEVD0)	
:READ:Standard:ACPower?	Returns the ACPR measurement results.
:READ:Standard:CCDF?	Returns the CCDF measurement results.
:READ:Standard:CHPower?	Returns the channel power measurement results.

Table 2-28: :READ commands (Option) (Cont.)

Header	Description
:READ:Standard:DISTRibution:CCDF?	Returns the distribution data of the CCDF measurement.
:READ:Standard:IM?	Returns the intermodulation measurement results.
:READ:Standard:OBWidth?	Returns the occupied bandwidth measurement results.
:READ:FL1XEVD0:PVTime?	Returns the gated output power measurement results.
:READ:Standard:SEMAsk?	Returns the spectrum emission mask measurement results.
:READ:Standard:SPECTrum:ACPower?	Returns spectrum waveform data of the ACPR measurement.
:READ:Standard:SPECTrum:CHPower?	Returns spectrum waveform data of the channel power measurement.
:READ:Standard:SPECTrum:IM?	Returns spectrum waveform data of the intermodulation measurement.
:READ:Standard:SPECTrum:OBWidth?	Returns spectrum waveform data of the OBW measurement.
:READ:FL1XEVD0:TAMPlitude:PVTime?	Returns the time amplitude for the gated output power measurement.
Option 27 3GPP-R5 analysis related (:Standard = :SADLR5_3GPP :SAULR5_3GPP)	
:READ:Standard:ACLR?	Returns the ACLR measurement results.
:READ:Standard:CFRequency?	Returns the carrier frequency measurement results.
:READ:Standard:CHPower?	Returns the channel power measurement results.
:READ:Standard:EBWidth?	Returns the EBW measurement results.
:READ:SADLR5_3GPP:MCAClr?	Returns the multi-carrier ACLR measurement results.
:READ:Standard:OBWidth?	Returns the OBW measurement results.
:READ:Standard:SEMAsk?	Returns the spectrum emission mask measurement results.
:READ:Standard:SPECTrum:ACLR?	Returns spectrum waveform data of the ACLR measurement.
:READ:Standard:SPECTrum:CFRequency?	Returns spectrum waveform data of the carrier frequency measurement.
:READ:Standard:SPECTrum:CHPower?	Returns spectrum waveform data of the channel power measurement.
:READ:Standard:SPECTrum:EBWidth?	Returns spectrum waveform data of the EBW measurement.
:READ:SADLR5_3GPP:SPECTrum:MCAClr?	Returns spectrum waveform data of multi-carrier ACLR measurement.
:READ:Standard:SPECTrum:OBWidth?	Returns spectrum waveform data of the OBW measurement.
:READ:Standard:SPECTrum:SEMAsk?	Returns waveform data of the spectrum emission mask measurement.
Option 28 TD-SCDMA analysis related	
:READ:TD_SCDMA:ACLR?	Returns the adjacent channel leakage power ratio measurement results.
:READ:TD_SCDMA:CHPower?	Returns the channel power measurement results.
:READ:TD_SCDMA:IM?	Returns the intermodulation measurement results.
:READ:TD_SCDMA:OBWidth?	Returns the occupied bandwidth measurement results.
:READ:TD_SCDMA:SEMAsk?	Returns the spectrum emission mask measurement results.
:READ:TD_SCDMA:SPECTrum:ACLR?	Returns spectrum waveform data of the ACLR measurement.
:READ:TD_SCDMA:SPECTrum:CHPower?	Returns spectrum waveform data of the channel power measurement.
:READ:TD_SCDMA:SPECTrum:IM?	Returns spectrum waveform data of the intermodulation measurement.

Table 2-28: :READ commands (Option) (Cont.)

Header	Description
:READ:TD_SCDMA:SPECTrum:OBWidth?	Returns the spectrum waveform data of the OBW measurement.
:READ:TD_SCDMA:SPECTrum:SEMask?	Returns waveform data of the spectrum emission mask measurement.
Option 29 WLAN analysis related	
:READ:SWLAN subgroup	IEEE802.11n (nx1) analysis related
:READ:SWLAN:SMASK?	Returns the result of the spectrum mask measurement.
:READ:SWLAN:SPECTrum:SMASK?	Returns spectrum waveform data of the spectrum mask measurement.
:READ:WLAN subgroup	WLAN analysis related
:READ:WLAN:POWer:TPOWer?	Returns spectrum waveform data of the transmit power measurement.
:READ:WLAN:SMASK?	Returns the result of the spectrum mask measurement.
:READ:WLAN:SPECTrum:SMASK?	Returns spectrum waveform data of the spectrum mask measurement.
:READ:WLAN:TPOWer?	Returns the results of the transmit power measurement.

:SENSE Commands

Set the detailed measurement conditions.

Table 2-29: :SENSE commands

Header	Description
[:SENSE]:ACPower subgroup	ACPR measurement related.
[:SENSE]:ACPower:BANDwidth[:BWIDth:ACHannel(?)	Sets the bandwidth of the next adjacent channel.
[:SENSE]:ACPower:BANDwidth[:BWIDth:INTEgration(?)	Sets the bandwidth of the main channel.
[:SENSE]:ACPower:CSPacing(?)	Sets the channel-to-channel spacing.
[:SENSE]:ACPower:FILTer:COEFFicient(?)	Sets the filter factor.
[:SENSE]:ACPower:FILTer:TYPE(?)	Selects a filter.
[:SENSE]:ADEMod subgroup	Analog modulation analysis related.
[:SENSE]:ADEMod:AM:CADetection(?)	Selects the carrier amplitude detection method.
[:SENSE]:ADEMod:BLOCK(?)	Sets the number of the block to be measured.
[:SENSE]:ADEMod:CARRier:OFFSet(?)	Sets the carrier frequency offset in the FM signal analysis.
[:SENSE]:ADEMod:CARRier:SEARch(?)	Determines whether to detect the FM carrier automatically.
[:SENSE]:ADEMod:FM:THREshold(?)	Sets the threshold level to determine a burst in the FM analysis.
[:SENSE]:ADEMod[:IMMEdiate]	Runs the analog modulation analysis.
[:SENSE]:ADEMod:LENGth(?)	Sets the length of the measurement range.
[:SENSE]:ADEMod:MODulation(?)	Selects the modulation.

Table 2-29: :SENSe commands (Cont.)

Header	Description
[:SENSe]:ADEMod:OFFSet(?)	Sets the measurement start position.
[:SENSe]:ADEMod:PM:THReshold(?)	Sets the threshold level to determine a burst in the PM analysis.
[:SENSe]:AVERage subgroup	Averaging related.
[:SENSe]:AVERage:CLEar	Restarts the averaging from the beginning.
[:SENSe]:AVERage:COUNT(?)	Sets the number of averages.
[:SENSe]:AVERage[:STATe](?)	Turns on or off averaging.
[:SENSe]:AVERage:TCONtrol(?)	Selects the operation when the number of averages is reached.
[:SENSe]:BSIZe subgroup	Block size setting.
[:SENSe]:BSIZe(?)	Sets the block size.
[:SENSe]:CCDF subgroup	CCDF measurement related.
[:SENSe]:CCDF:BLOCK(?)	Sets the number of the block to be measured.
[:SENSe]:CCDF:CLEar	Clears the CCDF accumulator and restarts the measurement.
[:SENSe]:CCDF:RMEasurement(?)	Clears the CCDF accumulator and restarts the measurement.
[:SENSe]:CCDF:THReshold(?)	Sets the threshold to include the samples in the CCDF calculation.
[:SENSe]:CFRequency subgroup	Carrier frequency measurement related.
[:SENSe]:CFRequency:CRESolution(?)	Sets the counter resolution.
[:SENSe]:CHPower subgroup	Channel power measurement related.
[:SENSe]:CHPower:BANDwidth[:BWIDTH:INTEgration](?)	Sets the channel bandwidth.
[:SENSe]:CHPower:FILTer:COEFFicient(?)	Sets the filter roll-off rate.
[:SENSe]:CHPower:FILTer:TYPE(?)	Selects the filter.
[:SENSe]:CNRatio subgroup	Carrier-to-Noise (C/N) measurement related.
[:SENSe]:CNRatio:BANDwidth[:BWIDTH:INTEgration](?)	Sets the measurement bandwidth.
[:SENSe]:CNRatio:BANDwidth[:BWIDTH:NOISe](?)	Sets the noise bandwidth.
[:SENSe]:CNRatio:FILTer:COEFFicient(?)	Sets the filter roll-off rate.
[:SENSe]:CNRatio:FILTer:TYPE(?)	Selects the filter.
[:SENSe]:CNRatio:OFFSet(?)	Sets the offset frequency.
[:SENSe]:CORRection subgroup	Amplitude correction related.
[:SENSe]:CORRection:DATA(?)	Sets amplitude correction data.
[:SENSe]:CORRection:DELeTe	Deletes amplitude correction data.
[:SENSe]:CORRection:OFFSet[:MAGNIitude](?)	Sets amplitude offset.
[:SENSe]:CORRection:OFFSet:FREQUency(?)	Sets frequency offset.
[:SENSe]:CORRection[:STATe](?)	Turns on or off amplitude correction.
[:SENSe]:CORRection:X:SPACing(?)	Selects scaling of the horizontal axis (frequency) for interpolation.
[:SENSe]:CORRection:Y:SPACing(?)	Selects scaling of the vertical axis (amplitude) for interpolation.

Table 2-29: :SENSe commands (Cont.)

Header	Description
[[:SENSe]:EBWidth subgroup	EBW measurement related.
[[:SENSe]:EBWidth:XDB(?)	Sets the relative power from the peak for the measurement.
[[:SENSe]:FEED subgroup	Input port related.
[[:SENSe]:FEED	Selects the input port (RF, IQ, or calibration signal).
[[:SENSe]:FREQuency subgroup	Frequency related.
[[:SENSe]:FREQuency:BAND?	Queries the measurement frequency band.
[[:SENSe]:FREQuency:CENTer(?)	Sets the center frequency.
[[:SENSe]:FREQuency:CENTer:STEP:AUTO(?)	Determines whether to set the step size automatically by span.
[[:SENSe]:FREQuency:CENTer:STEP[:INCRement](?)	Sets the step size of the center frequency.
[[:SENSe]:FREQuency:CHANnel(?)	Selects a channel.
[[:SENSe]:FREQuency:CTABLE:CATalog?	Queries the available channel tables.
[[:SENSe]:FREQuency:CTABLE[:SELect](?)	Selects a channel table.
[[:SENSe]:FREQuency:SPAN(?)	Sets the span.
[[:SENSe]:FREQuency:STARt(?)	Sets the start frequency.
[[:SENSe]:FREQuency:STOP(?)	Sets the stop frequency.
[[:SENSe]:OBWidth subgroup	OBW measurement related.
[[:SENSe]:OBWidth:PERCent(?)	Sets the occupied bandwidth.
[[:SENSe]:PULSe subgroup	Pulse characteristics analysis related
[[:SENSe]:PULSe:BLOCK(?)	Sets the number of the block to measure.
[[:SENSe]:PULSe:CHPower:BANDwidth[:BWIDth:INTEgration](?)	Sets the channel bandwidth for the channel power measurement.
[[:SENSe]:PULSe:CRESolution(?)	Sets the frequency measurement resolution.
[[:SENSe]:PULSe:EBWidth:XDB(?)	Sets the level at which the EBW is measured.
[[:SENSe]:PULSe:FFT:COEFFicient(?)	Sets the roll-off ratio for the Nyquist FFT window.
[[:SENSe]:PULSe:FFT:WINDow[:TYPE](?)	Selects the FFT window type.
[[:SENSe]:PULSe:FILTer:BANDwidth[:BWIDth](?)	Sets the bandwidth of the time measurement filter.
[[:SENSe]:PULSe:FILTer:COEFFicient(?)	Sets the a/BT value for the Gaussian measurement filter.
[[:SENSe]:PULSe:FILTer:MEASurement(?)	Selects the measurement filter for the time measurement.
[[:SENSe]:PULSe:FREQuency:OFFSet(?)	Sets the frequency offset.
[[:SENSe]:PULSe:FREQuency:RECOvery(?)	Selects the frequency recovery.
[[:SENSe]:PULSe[:IMMEdiate](?)	Runs calculation for acquired data.
[[:SENSe]:PULSe:LENGth(?)	Sets the length of the measurement range.
[[:SENSe]:PULSe:OBWidth:PERCent(?)	Sets OBW for the OBW measurement.
[[:SENSe]:PULSe:OFFSet(?)	Sets the measurement start position.
[[:SENSe]:PULSe:PTOffset(?)	Sets the time offset for the pulse-pulse phase measurement point.
[[:SENSe]:PULSe:THREshold(?)	Sets the threshold level to detect pulses in acquired data.

Table 2-29: :SENSe commands (Cont.)

Header	Description
[:SENSe]:ROSCillator subgroup	Reference oscillator related.
[:SENSe]:ROSCillator:SOURce(?)	Selects the reference oscillator.
[:SENSe]:SPEctrum subgroup	Spectrum related.
[:SENSe]:SPEctrum:AVERage:CLEar	Restarts the average process.
[:SENSe]:SPEctrum:AVERage:COUNt(?)	Sets the number of averages.
[:SENSe]:SPEctrum:AVERage:STATe(?)	Turns on or off averaging.
[:SENSe]:SPEctrum:AVERage:TYPE(?)	Selects the average type.
[:SENSe]:SPEctrum:Bandwidth:BWIDth:RESolution(?)	Sets the resolution bandwidth.
[:SENSe]:SPEctrum:Bandwidth:BWIDth:RESolution:AUTO(?)	Determines whether to automatically set the resolution bandwidth.
[:SENSe]:SPEctrum:Bandwidth:BWIDth:STATe(?)	Turns on or off the resolution bandwidth calculation process.
[:SENSe]:SPEctrum:Bandwidth:BWIDth:VIDeo(?)	Sets the frequency bandwidth of the video filter.
[:SENSe]:SPEctrum:Bandwidth:BWIDth:VIDeo:STATe(?)	Determines whether or not to use the video filter.
[:SENSe]:SPEctrum:Bandwidth:BWIDth:VIDeo:SWEEp[:TIME] (?)	Sets the sweep time for the video filter.
[:SENSe]:SPEctrum:DETEctor[:FUNCTION] (?)	Determines how the trace is compressed.
[:SENSe]:SPEctrum:FILTer:COEFFicient(?)	Sets the filter roll-off rate.
[:SENSe]:SPEctrum:FILTer:TYPE(?)	Selects the filter.
[:SENSe]:SPEctrum:FFT:ERESolution(?)	Determines whether to enable the extended resolution.
[:SENSe]:SPEctrum:FFT:LENGth(?)	Sets the number of FFT sample points.
[:SENSe]:SPEctrum:FFT:STARt(?)	Sets the FFT start point between 1024-point overlapped FFTs.
[:SENSe]:SPEctrum:FFT:WINDow[:TYPE] (?)	Selects a FFT window.
[:SENSe]:SPEctrum:FRAMe(?)	Sets the frame number for the spectrum measurement.
[:SENSe]:SPEctrum:MEASurement(?)	Runs a selected measurement item.
[:SENSe]:SPEctrum:ZOOM:BLOCK(?)	Sets the number of the block to zoom.
[:SENSe]:SPEctrum:ZOOM:FREQUency:CENTer(?)	Sets the center frequency of a zoomed area.
[:SENSe]:SPEctrum:ZOOM:FREQUency:WIDTh(?)	Sets the frequency width of a zoomed area.
[:SENSe]:SPEctrum:ZOOM:LENGth(?)	Sets the time length of a zoomed area.
[:SENSe]:SPEctrum:ZOOM:OFFSet(?)	Sets the starting point of a zoomed area.
[:SENSe]:SPURious subgroup	Spurious signal measurement related.
[:SENSe]:SPURious[:THReshold]:EXCURsion(?)	Sets the spurious excursion level.
[:SENSe]:SPURious[:THReshold]:IGNore(?)	Sets an area to ignore spurious.
[:SENSe]:SPURious[:THReshold]:SIGNal(?)	Sets the carrier criterion level.
[:SENSe]:SPURious[:THReshold]:SPURious(?)	Sets the spurious criterion level.

Table 2-29: :SENSe commands (Cont.)

Header	Description
[:SENSe]:TRANsient subgroup	Time analysis related.
[:SENSe]:TRANsient:BLOCK(?)	Sets the number of the block to be measured.
[:SENSe]:TRANsient[:IMMEDIATE]	Starts a time characteristic analysis.
[:SENSe]:TRANsient:ITEM(?)	Selects a measurement item.
[:SENSe]:TRANsient:LENGth(?)	Sets the length of the measurement range.
[:SENSe]:TRANsient:OFFSet(?)	Sets the measurement start position.

:SENSe Commands (Option)

Table 2-30 shows the :SENSe commands for optional analysis software.

Table 2-30: :SENSe commands (Option)

Header	Description
Option 21 Advanced measurement suite related	
[:SENSe]:DDEMod subgroup	Digital modulation analysis related.
[:SENSe]:DDEMod:BLOCK(?)	Sets the number of the block to be measured.
[:SENSe]:DDEMod:CARRier:OFFSet(?)	Sets the carrier frequency offset.
[:SENSe]:DDEMod:CARRier:SEARch(?)	Determines whether to detect the carrier automatically.
[:SENSe]:DDEMod:DECode(?)	Selects the method that is used to decode the data bits.
[:SENSe]:DDEMod:FDEVIation(?)	Sets the frequency deviation to determine two states for FSK.
[:SENSe]:DDEMod:FDEVIation:AUTO(?)	Selects whether to detect the frequency deviation automatically.
[:SENSe]:DDEMod:FILTer:ALPHa(?)	Sets the filter factor (α/BT).
[:SENSe]:DDEMod:FILTer:MEASurement(?)	Selects the measurement filter.
[:SENSe]:DDEMod:FILTer:REFerence(?)	Selects the reference filter.
[:SENSe]:DDEMod:FORMat(?)	Selects the modulation.
[:SENSe]:DDEMod[:IMMEDIATE]	Starts the digital modulation calculation.
[:SENSe]:DDEMod:LENGth(?)	Sets the measurement range.
[:SENSe]:DDEMod:MDEPth(?)	Sets the modulation depth to separate two states in ASK.
[:SENSe]:DDEMod:MDEPth:AUTO(?)	Determines whether to detect the modulation depth automatically.
[:SENSe]:DDEMod:NLINearity:COEFFicient(?)	Sets the maximum order of the best-fit curve polynomial.
[:SENSe]:DDEMod:NLINearity:HDIvISION(?)	Sets the horizontal interval between display points.
[:SENSe]:DDEMod:NLINearity:LSRegion[:SET](?)	Sets the linear signal region.
[:SENSe]:DDEMod:NLINearity:LSRegion:UNIT(?)	Selects the unit to set the liner signal region.
[:SENSe]:DDEMod:OFFSet(?)	Sets the measurement start position.

Table 2-30: :SENSe commands (Option) (Cont.)

Header	Description
[:SENSe]:DDEMod:PRESet(?)	Sets the default settings by the communication standard.
[:SENSe]:DDEMod:SRATe(?)	Sets the symbol rate.
[:SENSe]:RFID subgroup	RFID analysis related.
[:SENSe]:RFID:ACPower:Bandwidth[:BWidth:ACHannel](?)	Sets the adjacent channel bandwidth in the ACPR measurement.
[:SENSe]:RFID:ACPower:Bandwidth[:BWidth:INTEgration](?)	Sets the main channel bandwidth in the ACPR measurement.
[:SENSe]:RFID:ACPower:CSPacing(?)	Sets the channel-to-channel spacing in the ACPR measurement.
[:SENSe]:RFID:ACPower:FiLTer:COEFFicient(?)	Sets the filter factor in the ACPR measurement.
[:SENSe]:RFID:ACPower:FiLTer:TYPE(?)	Selects the filter for the ACPR measurement.
[:SENSe]:RFID:BLOCK(?)	Sets the number of the block to measure.
[:SENSe]:RFID:CARRier:Bandwidth[:BWidth:INTEgration](?)	Sets the channel bandwidth for the maximum EIRP.
[:SENSe]:RFID:CARRier:COUNter[:RESolution](?)	Sets the counter resolution for the carrier measurement.
[:SENSe]:RFID:CARRier:OFFSet(?)	Sets the amplitude offset for the maximum EIRP.
[:SENSe]:RFID:CARRier:PRATio[:SET](?)	Sets the power ratio for the OBW measurement.
[:SENSe]:RFID:CARRier:PRATio:UNIT(?)	Selects the power ratio unit for the OBW measurement.
[:SENSe]:RFID[:IMMediate]	Perform analysis calculation for the acquired data.
[:SENSe]:RFID:LENGth(?)	Sets the analysis range.
[:SENSe]:RFID:MEASurement(?)	Selects the measurement item.
[:SENSe]:RFID:MODulation:ADVanced:FiLTer(?)	Selects the measurement filter.
[:SENSe]:RFID:MODulation:ADVanced:PREamble(?)	Determines whether to search for the preamble.
[:SENSe]:RFID:MODulation:ADVanced:SBANd(?)	Selects the sideband to analyze.
[:SENSe]:RFID:MODulation:BRATe:AUTO(?)	Determines whether to set the bit rate automatically.
[:SENSe]:RFID:MODulation:BRATe[:SET](?)	Sets the bit rate.
[:SENSe]:RFID:MODulation:DECode(?)	Selects the decoding format.
[:SENSe]:RFID:MODulation:FORMat(?)	Selects the modulation format.
[:SENSe]:RFID:MODulation:INTErpolate(?)	Sets the number of waveform interpolation points.
[:SENSe]:RFID:MODulation:LINK(?)	Selects the link.
[:SENSe]:RFID:MODulation:SERRor[:WIDTh](?)	Sets an error range for determining the settling time.
[:SENSe]:RFID:MODulation:STANdard(?)	Selects the demodulation standard.
[:SENSe]:RFID:MODulation:TARI:AUTO(?)	Determines whether to set Tari automatically.
[:SENSe]:RFID:MODulation:TARI[:SET](?)	Sets Tari.
[:SENSe]:RFID:MODulation[:THReshold]:HIGHer(?)	Sets or queries the higher threshold for measuring a rise/fall time.
[:SENSe]:RFID:MODulation[:THReshold]:LOWer(?)	Sets or queries the lower threshold for measuring a rise/fall time.
[:SENSe]:RFID:OFFSet(?)	Sets the measurement start position.
[:SENSe]:RFID:SPURious[:THReshold]:EXCURsion(?)	Sets the excursion level in the spurious measurement.
[:SENSe]:RFID:SPURious[:THReshold]:IGNore(?)	Sets the region not to detect spurious signals.

Table 2-30: :SENSe commands (Option) (Cont.)

Header	Description
[:SENSe]:RFID:SPURious[:THReshold]:SIGNal(?)	Sets the threshold level to determine if the signal is the carrier.
[:SENSe]:RFID:SPURious[:THReshold]:SPURious(?)	Sets the threshold level to determine if the signal is spurious.
[:SENSe]:RFID:ZOOM:FREQuency:CENTer(?)	Sets or queries the center frequency of a zoomed area.
[:SENSe]:RFID:ZOOM:FREQuency:WIDTh(?)	Sets the frequency width of a zoomed area.
[:SENSe]:SSource subgroup	Signal source analysis related.
[:SENSe]:SSource:BLOCK(?)	Sets the number of the block to measure.
[:SENSe]:SSource:CARRier:BANDwidth[:BWIDth:INTegration(?)	Sets the frequency bandwidth to calculate channel power.
[:SENSe]:SSource:CARRier[:THReshold](?)	Sets the threshold for carrier detection.
[:SENSe]:SSource:CARRier:TRACking[:STATe](?)	Determines whether to enable or disable the carrier tracking.
[:SENSe]:SSource:CNRatio:FFT:LENGth(?)	Sets the number of FFT samples per frame.
[:SENSe]:SSource:CNRatio:OFFSet(?)	Sets the frequency displaying the C/N versus Time in the subview.
[:SENSe]:SSource:CNRatio:SBAND(?)	Selects the sideband for measuring phase noise.
[:SENSe]:SSource:CNRatio[:THReshold](?)	Sets the threshold for obtaining the phase noise settling time.
[:SENSe]:SSource:FVTime:SMOothing(?)	Sets the smoothing factor in the frequency vs. time measurement.
[:SENSe]:SSource:FVTime[:THReshold](?)	Sets the threshold to determine the frequency settling time.
[:SENSe]:SSource[:IMMEDIATE]	Perform calculation for the acquired data.
[:SENSe]:SSource:LENGth(?)	Sets the analysis range.
[:SENSe]:SSource:MEASurement(?)	Selects and runs the measurement in the signal source analysis.
[:SENSe]:SSource:OFFSet(?)	Sets the measurement start position.
[:SENSe]:SSource:PNOise:MPJitter[:THReshold](?)	Sets the threshold level to determine periodic jitter.
[:SENSe]:SSource:PNOise:RJITter:OFFSet:STARt(?)	Sets the random jitter measurement start offset frequency.
[:SENSe]:SSource:PNOise:RJITter:OFFSet:STOP(?)	Sets the random jitter measurement stop offset frequency.
[:SENSe]:SSource:PNOise:RJITter[:THReshold](?)	Sets the threshold for obtaining the random jitter settling time.
[:SENSe]:SSource:PNOise:OFFSet:MAXimum(?)	Sets the maximum frequency in the phase noise measurement.
[:SENSe]:SSource:PNOise:OFFSet:MINimum(?)	Sets the minimum frequency in the phase noise measurement.
[:SENSe]:SSource:SPURious:IGNore(?)	Sets the ignore region in the spurious measurement.
[:SENSe]:SSource:SPURious:SFILter[:STATe](?)	Determines whether to enable the symmetrical filter.
[:SENSe]:SSource:SPURious[:THReshold]:EXCURsion(?)	Sets the excursion in the spurious measurement.
[:SENSe]:SSource:SPURious[:THReshold]:SPURious(?)	Sets the spurious threshold in the spurious measurement.
Option 23 W-CDMA uplink analysis related	
[:SENSe]:AC3Gpp subgroup	W-CDMA ACLR measurement related.
[:SENSe]:AC3Gpp:FILter:ALPHA(?)	Sets the filter factor (α /BT).
[:SENSe]:AC3Gpp:FILter:TYPE(?)	Selects a filter.

Table 2-30: :SENSe commands (Option) (Cont.)

Header	Description
[[:SENSe]:UL3Gpp subgroup	Related to W-CDMA uplink analysis.
[[:SENSe]:UL3Gpp:BLOCK(?)]	Sets the number of the block to be measured.
[[:SENSe]:UL3Gpp:CARRier:OFFSet(?)]	Sets the carrier frequency offset.
[[:SENSe]:UL3Gpp:CARRier:SEARch(?)]	Determines whether to detect the carrier automatically.
[[:SENSe]:UL3Gpp:FILTer:ALPHA(?)]	Sets the filter factor (α /BT).
[[:SENSe]:UL3Gpp:FILTer:MEASurement(?)]	Sets the measurement filter.
[[:SENSe]:UL3Gpp:FILTer:REFerence(?)]	Sets the reference filter.
[[:SENSe]:UL3Gpp[:IMMediate]	Starts W-CDMA downlink analysis calculation.
[[:SENSe]:UL3Gpp:LENGth(?)]	Sets the measurement range.
[[:SENSe]:UL3Gpp:MMODE(?)]	Selects the mobile mode for measurement.
[[:SENSe]:UL3Gpp:OFFSet(?)]	Sets the measurement start position.
[[:SENSe]:UL3Gpp:SCODE:NUMBer(?)]	Sets the scrambling code number.
[[:SENSe]:UL3Gpp:SCODE:TYPE(?)]	Selects the scrambling code type.
[[:SENSe]:UL3Gpp:THReshold(?)]	Sets the threshold to determine a burst.
Option 24 GSM/EDGE analysis related	
[[:SENSe]:GSMedge subgroup	GSM/EDGE analysis related.
[[:SENSe]:GSMedge:ABITs(?)]	Sets the number of symbols for EVM measurement
[[:SENSe]:GSMedge:BLOCK(?)]	Sets the number of the block to be measured.
[[:SENSe]:GSMedge:BURSt:INDEX(?)]	Sets the number of the burst to be measured.
[[:SENSe]:GSMedge:BURSt:MPOint(?)]	Defines center of the mask in the power versus time measurement
[[:SENSe]:GSMedge:BURSt:RTFirst(?)]	Return to the first burst.
[[:SENSe]:GSMedge:CARRier:OFFSet(?)]	Sets the carrier frequency offset.
[[:SENSe]:GSMedge:CARRier:SEARch(?)]	Determines whether to detect the carrier automatically.
[[:SENSe]:GSMedge:FILTer:RCWRcosine(?)]	Determines whether to enable the RCW raised cosine filter.
[[:SENSe]:GSMedge[:IMMediate]	Starts calculation for the GSM/EDGE analysis.
[[:SENSe]:GSMedge:LIMit:SIGNal(?)]	Sets the threshold level to determine the normal signal.
[[:SENSe]:GSMedge:LIMit:SPURious(?)]	Sets the threshold level to determine the spurious signal.
[[:SENSe]:GSMedge:MEASurement(?)]	Selects the GSM/EDGE measurement item.
[[:SENSe]:GSMedge:MODulation(?)]	Selects the modulation system for the GSM/EDGE analysis.
[[:SENSe]:GSMedge:SLOT(?)]	Sets the number of slots for one block
[[:SENSe]:GSMedge:STANdard:BAND(?)]	Selects the standard for the GSM/EDGE analysis.
[[:SENSe]:GSMedge:STANdard:DIRection(?)]	Selects the link direction for the GSM/EDGE analysis.
[[:SENSe]:GSMedge:STINDEX(?)]	Sets the column number in the spurious table.
[[:SENSe]:GSMedge:TSCode:AUTO(?)]	Determines whether to set TSC number automatically.
[[:SENSe]:GSMedge:TSCode[:NUMBer](?)	Sets the TSC (Training Sequence Code) number.

Table 2-30: :SENSe commands (Option) (Cont.)

Header	Description
Option 25 cdma2000 analysis related (:Standard = :FLCDMA2K :RLCDMA2K)	
[:SENSe]:Standard subgroup	cdma2000 analysis related.
[:SENSe]:Standard:ACQuisition:CHIPs(?)	Sets the acquisition length in chips.
[:SENSe]:Standard:ACQuisition:HISTory(?)	Sets the acquisition history.
[:SENSe]:Standard:ACQuisition:SECOnds(?)	Sets the acquisition length in seconds.
[:SENSe]:Standard:ANALYsis:INTerval(?)	Sets the analysis interval.
[:SENSe]:Standard:ANALYsis:OFFSet(?)	Sets the analysis offset.
[:SENSe]:Standard:BLOCK(?)	Sets the number of the block to be measured.
[:SENSe]:Standard:[IMMEDIATE]	Starts the calculation for the acquired data.
[:SENSe]:Standard:MEASurement(?)	Selects the measurement item.
[:SENSe]:Standard:SPECTrum:OFFSet(?)	Sets the spectrum offset within the time window.
[:SENSe]:Standard:SPECTrum:TINTerval?	Returns the length of the time-domain information.
[:SENSe]:Standard:ACPower subgroup	ACPR measurement related.
[:SENSe]:Standard:ACPower:BANDwidth:BWIDth:INTegration(?)	Sets the bandwidth of the main channel.
[:SENSe]:Standard:ACPower:FILTer:COEFFicient(?)	Sets the filter roll-off rate for the ACPR measurement.
[:SENSe]:Standard:ACPower:FILTer:TYPE(?)	Sets the filter for the ACPR measurement.
[:SENSe]:Standard:ACPower:LIMit:ADJacent<x>[:STATe](?)	Determines whether to enable or disable the adjacent limit testing.
[:SENSe]:Standard:CCDF subgroup	CCDF measurement related.
[:SENSe]:Standard:CCDF:RMEasurement	Clears the CCDF accumulator and restarts the measurement.
[:SENSe]:Standard:CCDF:THREShold(?)	Sets the threshold for the CCDF measurement.
[:SENSe]:Standard:CDPower subgroup	Code domain power measurement related.
[:SENSe]:Standard:CDPower:ACCThreshold(?)	Sets the active channel threshold level.
[:SENSe]:Standard:CDPower:FILTer:MEASurement(?)	Selects the measurement filter.
[:SENSe]:Standard:CDPower:IQSWap(?)	Determines whether to enable or disable IQ swapping.
[:SENSe]:Standard:CDPower:MLEVel(?)	Selects the measurement level.
[:SENSe]:FLCDMA2K:CDPower:PNOFFset(?)	Sets the PN offset for the code domain power measurement.
[:SENSe]:FLCDMA2K:CDPower:QOF(?)	Sets the quasi-orthogonal function.
[:SENSe]:FLCDMA2K:RLCDMA2K:CDPower:RCONfig(?)	Selects the radio configuration for the CDP measurement.
[:SENSe]:Standard:CDPower:SELEct:CODE(?)	Sets the code in the halfslot.
[:SENSe]:Standard:CDPower:SELEct:PCG(?)	Sets the PCG for the code domain power measurement.
[:SENSe]:Standard:CDPower:WCODE(?)	Sets the Walsh code length.

Table 2-30: :SENSE commands (Option) (Cont.)

Header	Description
[:SENSE]:Standard:CHPower subgroup	Channel power measurement related.
[:SENSE]:Standard:CHPower:BANDwidth[:BWIDth:INTEgration](?)	Sets the channel bandwidth for the channel power measurement.
[:SENSE]:Standard:CHPower:FILTer:COEFFicient(?)	Sets the filter roll-off rate for the channel power measurement.
[:SENSE]:Standard:CHPower:FILTer:TYPE(?)	Selects the filter for the channel power measurement.
[:SENSE]:Standard:CHPower:LIMit[:STATe](?)	Determines whether to enable or disable the limit testing.
[:SENSE]:Standard:IM subgroup	Intermodulation measurement related.
[:SENSE]:Standard:IM:BANDwidth[:BWIDth:INTEgration](?)	Sets the bandwidth of the main channel.
[:SENSE]:Standard:IM:FILTer:COEFFicient(?)	Sets the filter roll-off rate for the intermodulation measurement.
[:SENSE]:Standard:IM:FILTer:TYPE(?)	Selects the filter for the intermodulation measurement.
[:SENSE]:Standard:IM:LIMit:FORDer[:STATe](?)	Sets whether to enable or disable the fifth order limit testing.
[:SENSE]:Standard:IM:LIMit:TORDer[:STATe](?)	Sets whether to enable or disable the third order limit testing.
[:SENSE]:Standard:IM:SCOFFset(?)	Sets the frequency of the second channel.
[:SENSE]:Standard:MACCuracy subgroup	Modulation accuracy measurement related.
[:SENSE]:Standard:MACCuracy:ACCThreshold(?)	Sets the level to decide whether a code channel is active or not.
[:SENSE]:Standard:MACCuracy:FILTer:MEASurement(?)	Selects the measurement filter.
[:SENSE]:Standard:MACCuracy:IQSWap(?)	Determines whether to enable or disable IQ swapping.
[:SENSE]:Standard:MACCuracy:LIMit:EVM:PEAK[:STATe](?)	Sets whether to enable or disable the Peak EVM limit testing.
[:SENSE]:Standard:MACCuracy:LIMit:EVM:RMS[:STATe](?)	Sets whether to enable or disable the RMS EVM limit testing.
[:SENSE]:Standard:MACCuracy:LIMit:PCDError[:STATe](?)	Sets whether to enable the Peak Code Domain Error limit testing.
[:SENSE]:Standard:MACCuracy:LIMit:RHO[:STATe](?)	Sets whether to enable or disable the Rho limit testing.
[:SENSE]:FLCDMA2K:MACCuracy:LIMit:TAU[:STATe](?)	Sets whether to enable or disable the Tau limit testing.
[:SENSE]:Standard:MACCuracy:MLeVel(?)	Selects the measurement level.
[:SENSE]:FLCDMA2K:MACCuracy:PNOffset(?)	Sets the PN offset for the modulation accuracy measurement.
[:SENSE]:FLCDMA2K:MACCuracy:QOF(?)	Sets the quasi-orthogonal function.
[:SENSE]:Standard:MACCuracy:RCONfig(?)	Sets the radio configuration.
[:SENSE]:Standard:MACCuracy:SElect:CODE(?)	Sets the code in the halfslot.
[:SENSE]:Standard:MACCuracy:SElect:PCG(?)	Sets the PCG for the modulation accuracy measurement.
[:SENSE]:Standard:MACCuracy:WCODe(?)	Sets the Walsh code length.
[:SENSE]:Standard:OBWidth subgroup	OBW measurement related.
[:SENSE]:Standard:OBWidth:LIMit[:STATe](?)	Determines whether to enable or disable the limit testing.
[:SENSE]:Standard:OBWidth:PERCent(?)	Sets the occupied bandwidth.
[:SENSE]:Standard:PCCHannel subgroup	Pilot to code channel measurement related.
[:SENSE]:Standard:PCCHannel:ACCThreshold(?)	Sets the level to decide whether a code channel is active or not.
[:SENSE]:Standard:PCCHannel:FILTer:MEASurement(?)	Selects the measurement filter.
[:SENSE]:Standard:PCCHannel:IQSWap(?)	Determines whether to enable or disable IQ swapping.

Table 2-30: :SENSe commands (Option) (Cont.)

Header	Description
[:SENSe]:Standard:PCCHannel:LIMit:PHASe[:STATe](?)	Determines whether to enable or disable the phase limit testing.
[:SENSe]:Standard:PCCHannel:LIMit:TIME[:STATe](?)	Determines whether to enable or disable the time limit testing.
[:SENSe]:FLCDMA2K:PCCHannel:PNOFFset(?)	Sets the PN offset for the pilot to code channel measurement.
[:SENSe]:Standard:PCCHannel:RCONfig(?)	Sets the radio configuration.
[:SENSe]:Standard:PCCHannel:SElect:CODE(?)	Sets the code in the halfslot.
[:SENSe]:Standard:PCCHannel:SElect:PCG(?)	Sets the PCG for the pilot to code channel measurement.
[:SENSe]:Standard:PCCHannel:WCODe(?)	Sets the Walsh code length.
[:SENSe]:RLCDMA2K:PVTime subgroup	Power versus time measurement related.
[:SENSe]:RLCDMA2K:PVTime:BURSt:GATE(?)	Sets the burst gate for the power versus time measurement.
[:SENSe]:RLCDMA2K:PVTime:BURSt:OFFSet(?)	Sets the burst offset between the trigger and the burst position.
[:SENSe]:RLCDMA2K:PVTime:BURSt:SYNC(?)	Selects the burst sync for the power versus time measurement.
[:SENSe]:RLCDMA2K:PVTime:LIMit:ZONE<x>[:STATe](?)	Sets whether to enable or disable the zone limit testing.
[:SENSe]:RLCDMA2K:PVTime:RCHannel:LEVel(?)	Sets the reference channel level for measuring power.
[:SENSe]:RLCDMA2K:PVTime:RCHannel:MODE(?)	Selects the reference channel level mode for measuring power.
[:SENSe]:Standard:SEMAsk subgroup	Spectrum emission mask measurement related.
[:SENSe]:Standard:SEMAsk:BANDwidth[:BWIDTh:INTegration](?)	Sets the channel bandwidth.
[:SENSe]:Standard:SEMAsk:FILTer:COEFFicient(?)	Sets the filter roll-off rate.
[:SENSe]:Standard:SEMAsk:FILTer:TYPE(?)	Selects the filter for the spectrum emission mask measurement.
[:SENSe]:Standard:SEMAsk:LIMit:ISPurious:ZONE<x>[:STATe](?)	Sets whether to enable the inband spurious zone limit testing.
[:SENSe]:Standard:SEMAsk:LIMit:OFCHannel:ZONE<x>[:STATe](?)	Determines whether to enable or disable the offset from the channel zone limit testing.
[:SENSe]:Standard:SEMAsk:MEASurement(?)	Selects the limit table type.
[:SENSe]:Standard:SEMAsk:RCHannel:LEVel(?)	Sets the reference channel level for measuring spurious.
[:SENSe]:Standard:SEMAsk:RCHannel:MODE(?)	Selects the reference channel level mode for measuring spurious.
Option 26 1xEV-DO analysis related (:Standard = :FL1XEVD0 :RL1XEVD0)	
[:SENSe]:Standard subgroup	1xEV-DO analysis related.
[:SENSe]:Standard:ACQuisition:CHIPs(?)	Sets the acquisition length in chips.
[:SENSe]:Standard:ACQuisition:HISTory(?)	Sets the acquisition history.
[:SENSe]:Standard:ACQuisition:SEConds(?)	Sets the acquisition length in seconds.
[:SENSe]:Standard:ANALysis:INTerval(?)	Sets the analysis interval.
[:SENSe]:Standard:ANALysis:OFFSet(?)	Sets the analysis offset.
[:SENSe]:Standard:BLOCK(?)	Sets the number of the block to be measured.
[:SENSe]:Standard[:IMMEDIATE]	Starts the calculation for the acquired data.
[:SENSe]:Standard:MEASurement(?)	Selects the measurement item.

Table 2-30: :SENSe commands (Option) (Cont.)

Header	Description
<code>[:SENSe]:Standard:SPEctrum:OFFSet(?)</code>	Sets the spectrum offset within the time window.
<code>[:SENSe]:Standard:SPEctrum:TINterval?</code>	Returns the length of the time-domain information.
[:SENSe]:Standard:ACPower subgroup	ACPR measurement related.
<code>[:SENSe]:Standard:ACPower:BANDwidth :BWIDTH:INTegration(?)</code>	Sets the bandwidth of the main channel.
<code>[:SENSe]:Standard:ACPower:FILTer:COEFFicient(?)</code>	Sets the filter roll-off rate for the ACPR measurement.
<code>[:SENSe]:Standard:ACPower:FILTer:TYPE(?)</code>	Sets the filter for the ACPR measurement.
<code>[:SENSe]:Standard:ACPower:LIMit:ADJacent<x>[:STATe](?)</code>	Determines whether to enable or disable the adjacent limit testing.
[:SENSe]:Standard:CCDF subgroup	CCDF measurement related.
<code>[:SENSe]:Standard:CCDF:RMEasurement</code>	Clears the CCDF accumulator and restarts the measurement.
<code>[:SENSe]:Standard:CCDF:THREshold(?)</code>	Sets the threshold for the CCDF measurement.
[:SENSe]:Standard:CDPower subgroup	Code domain power measurement related.
<code>[:SENSe]:Standard:CDPower:ACCThreshold(?)</code>	Sets the active channel threshold level.
<code>[:SENSe]:FL1XEVD0:CDPower:CHANnel[:TYPE](?)</code>	Selects the channel type.
<code>[:SENSe]:Standard:CDPower:FILTer:MEASurement(?)</code>	Selects the measurement filter.
<code>[:SENSe]:Standard:CDPower:IQSWap(?)</code>	Sets whether to enable or disable IQ swapping.
<code>[:SENSe]:RL1XEVD0:CDPower:LCMask:I(?)</code>	Sets the 11-digit mask of the I long code.
<code>[:SENSe]:RL1XEVD0:CDPower:LCMask:Q(?)</code>	Sets the 11-digit mask of the Q long code.
<code>[:SENSe]:Standard:CDPower:MLeVel(?)</code>	Selects the measurement level.
<code>[:SENSe]:FL1XEVD0:CDPower:PNOFFset(?)</code>	Sets the PN offset for the code domain power measurement.
<code>[:SENSe]:Standard:CDPower:SElect:CODE(?)</code>	Sets the code in the halfslot.
<code>[:SENSe]:Standard:CDPower:SElect:HSLot(?)</code>	Sets the halfslot for the code domain power measurement.
[:SENSe]:Standard:CHPower subgroup	Channel power measurement related.
<code>[:SENSe]:Standard:CHPower:BANDwidth :BWIDTH:INTegration(?)</code>	Sets the channel bandwidth for the channel power measurement.
<code>[:SENSe]:Standard:CHPower:FILTer:COEFFicient(?)</code>	Sets the filter roll-off rate for the channel power measurement.
<code>[:SENSe]:Standard:CHPower:FILTer:TYPE(?)</code>	Selects the filter for the channel power measurement.
<code>[:SENSe]:Standard:CHPower:LIMit[:STATe](?)</code>	Determines whether to enable or disable the limit testing.
[:SENSe]:Standard:IM subgroup	Intermodulation measurement related.
<code>[:SENSe]:Standard:IM:BANDwidth :BWIDTH:INTegration(?)</code>	Sets the bandwidth of the main channel.
<code>[:SENSe]:Standard:IM:FILTer:COEFFicient(?)</code>	Sets the filter roll-off rate for the intermodulation measurement.
<code>[:SENSe]:Standard:IM:FILTer:TYPE(?)</code>	Selects the filter for the intermodulation measurement.
<code>[:SENSe]:Standard:IM:LIMit:FORDER[:STATe](?)</code>	Sets whether to enable or disable the fifth order limit testing.
<code>[:SENSe]:Standard:IM:LIMit:TORDER[:STATe](?)</code>	Sets whether to enable or disable the third order limit testing.
<code>[:SENSe]:Standard:IM:SCOFFset(?)</code>	Sets the frequency of the second channel.

Table 2-30: :SENSe commands (Option) (Cont.)

Header	Description
[:SENSe]:Standard:MACCuracy subgroup	Modulation accuracy measurement related.
[:SENSe]:Standard:MACCuracy:ACCThreshold(?)	Sets the leve to decide whether a code channel is active or not.
[:SENSe]:FL1XEVD0:MACCuracy:CHANnel[:TYPE](?)	Selects the channel type.
[:SENSe]:Standard:MACCuracy:FILTer:MEASurement(?)	Selects the measurement filter.
[:SENSe]:Standard:MACCuracy:IQSWap(?)	Sets whether to enable or disable IQ swapping.
[:SENSe]:RL1XEVD0:MACCuracy:LCMask:l(?)	Sets the 11-digit mask of the I long code.
[:SENSe]:RL1XEVD0:MACCuracy:LCMask:Q(?)	Sets the 11-digit mask of the Q long code.
[:SENSe]:Standard:MACCuracy:LIMit:EVM:PEAK[:STATe](?)	Sets whether to enable or disable the Peak EVM limit testing.
[:SENSe]:Standard:MACCuracy:LIMit:EVM:RMS[:STATe](?)	Sets whether to enable or disable the RMS EVM limit testing.
[:SENSe]:Standard:MACCuracy:LIMit:PCDerror[:STATe](?)	Sets whether to enable the Peak Code Domain Error limit testing.
[:SENSe]:Standard:MACCuracy:LIMit:RHO[:STATe](?)	Sets whether to enable or disable the Rho limit testing.
[:SENSe]:FL1XEVD0:MACCuracy:LIMit:TAU[:STATe](?)	Sets whether to enable or disable the Tau limit testing.
[:SENSe]:Standard:MACCuracy:MLEVel(?)	Selects the measurement level.
[:SENSe]:FL1XEVD0:MACCuracy:PNOFset(?)	Sets the PN offset for the modulation accuracy measurement.
[:SENSe]:Standard:MACCuracy:SElect:CODE(?)	Sets the code in the halfslot.
[:SENSe]:Standard:MACCuracy:SElect:HSLot(?)	Sets the halfslot for the modulation accuracy measurement.
[:SENSe]:Standard:OBWidth subgroup	OBW measurement related.
[:SENSe]:Standard:OBWidth:LIMit[:STATe](?)	Sets whether to enable or disable the limit testing.
[:SENSe]:Standard:OBWidth:PERCent(?)	Sets the occupied bandwidth.
[:SENSe]:Standard:PCCHannel subgroup	Pilot to code channel measurement related.
[:SENSe]:Standard:PCCHannel:ACCThreshold(?)	Sets the level to decide whether a code channel is active or not.
[:SENSe]:FL1XEVD0:PCCHannel:CHANnel[:TYPE](?)	Selects the channel type.
[:SENSe]:Standard:PCCHannel:FILTer:MEASurement(?)	Selects the measurement filter.
[:SENSe]:Standard:PCCHannel:IQSWap(?)	Sets whether to enable or disable IQ swapping.
[:SENSe]:RL1XEVD0:PCCHannel:LCMask:l(?)	Sets the 11-digit mask of the I long code.
[:SENSe]:RL1XEVD0:PCCHannel:LCMask:Q(?)	Sets the 11-digit mask of the Q long code.
[:SENSe]:Standard:PCCHannel:LIMit:PHASe[:STATe](?)	Sets whether to enable or disable the phase limit testing.
[:SENSe]:Standard:PCCHannel:LIMit:TIME[:STATe](?)	Sets whether to enable or disable the time limit testing.
[:SENSe]:FL1XEVD0:PCCHannel:PNOFset(?)	Sets the PN offset for the pilot to code channel measurement.
[:SENSe]:Standard:PCCHannel:SElect:CODE(?)	Sets the code in the halfslot.
[:SENSe]:Standard:PCCHannel:SElect:HSLot(?)	Sets the halfslot for the pilot to code channel measurement.
[:SENSe]:FL1XEVD0:PVTime subgroup	Power versus time measurement related.
[:SENSe]:FL1XEVD0:PVTime:BURSt:OFFSet(?)	Selects burst offset between the trigger and the burst position.
[:SENSe]:FL1XEVD0:PVTime:BURSt:SYNC(?)	Selects the burst sync for the power versus time measurement.
[:SENSe]:FL1XEVD0:PVTime:LIMit:ZONE<x>[:STATe](?)	Sets whether to enable or disable the zone limit testing.

Table 2-30: :SENSe commands (Option) (Cont.)

Header	Description
[:SENSe]:FL1XEVD0:PVTIme:RCHannel:LEVel(?)	Sets the reference channel level for measuring power.
[:SENSe]:FL1XEVD0:PVTIme:RCHannel:MODE(?)	Selects the reference channel level mode for measuring power.
[:SENSe]:FL1XEVD0:PVTIme:SLOT[:TYPE](?)	Selects the slot type.
[:SENSe]:Standard:SEMask subgroup	Spectrum emission mask measurement related.
[:SENSe]:Standard:SEMask:BANDwidth[:BWIDTH:INTEgration(?)	Sets the channel bandwidth.
[:SENSe]:FL1XEVD0:SEMask:BURSt:OFFSet(?)	Selects burst offset between the trigger and the burst position.
[:SENSe]:FL1XEVD0:SEMask:BURSt:SYNC(?)	Sets the burst sync.
[:SENSe]:Standard:SEMask:FILTer:COEFficient(?)	Sets the filter roll-off rate.
[:SENSe]:Standard:SEMask:FILTer:TYPE(?)	Selects the filter for the spectrum emission mask measurement.
[:SENSe]:Standard:SEMask:LIMit:ISPurious:ZONE<x>[:STATE](?)	Sets whether to enable the inband spurious zone limit testing.
[:SENSe]:Standard:SEMask:LIMit:OFCHannel:ZONE<x>[:STATE](?)	Determines whether to enable or disable the offset from the channel zone limit testing.
[:SENSe]:Standard:SEMask:MEASurement(?)	Selects the limit table type.
[:SENSe]:Standard:SEMask:RCHannel:LEVel(?)	Sets the reference channel level.
[:SENSe]:Standard:SEMask:RCHannel:MODE(?)	Selects the reference channel level mode.
[:SENSe]:FL1XEVD0:SEMask:SLOT:GATE(?)	Sets the slot gate time.
[:SENSe]:FL1XEVD0:SEMask:SLOT[:TYPE](?)	Sets the slot type (Idle or Active).
Option 27 3GPP-R5 analysis related (:Standard = :SADLR5_3GPP :SAULR5_3GPP)	
[:SENSe]:DLR5_3GPP subgroup	Related to modulation analysis for 3GPP-R5 downlink
[:SENSe]:DLR5_3GPP:BLOCK(?)	Sets the number of the block to measure.
[:SENSe]:DLR5_3GPP:CARRier:OFFSet(?)	Sets the carrier frequency offset.
[:SENSe]:DLR5_3GPP:CARRier:SEARch(?)	Determines whether to detect the carrier automatically.
[:SENSe]:DLR5_3GPP:COMPosite(?)	Determines whether to perform the composite analysis.
[:SENSe]:DLR5_3GPP:DTYPE:SEARch(?)	Sets whether to detect the demodulation type of code channel.
[:SENSe]:DLR5_3GPP:EVM:IQOffset(?)	Determines whether to include the I/Q origin offset in the analysis.
[:SENSe]:DLR5_3GPP:FILTer:ALPHa(?)	Sets the filter factor.
[:SENSe]:DLR5_3GPP:FILTer:MEASurement(?)	Selects the measurement filter.
[:SENSe]:DLR5_3GPP:FILTer:REFerence(?)	Selects the reference filter.
[:SENSe]:DLR5_3GPP[:IMMEDIATE]	Runs the downlink analysis calculation on the acquired data.
[:SENSe]:DLR5_3GPP:LENGth(?)	Defines the analysis range.
[:SENSe]:DLR5_3GPP:OFFSet(?)	Sets the measurement start position.
[:SENSe]:DLR5_3GPP:SCHPart(?)	Determines whether to include the SCH part in the analysis.
[:SENSe]:DLR5_3GPP:SCODE:ALTErnative(?)	Selects the alternative scrambling code.
[:SENSe]:DLR5_3GPP:SCODE:NUMBer(?)	Sets the scrambling code.
[:SENSe]:DLR5_3GPP:SCODE:SEARch(?)	Determines whether to detect the scrambling code automatically.

Table 2-30: :SENSe commands (Option) (Cont.)

Header	Description
[:SENSe]:Standard:ACLR subgroup	Related to the ACLR measurement.
[:SENSe]:Standard:ACLR:FiLTer:COEFFicient(?)	Sets the filter factor (a/BT).
[:SENSe]:Standard:ACLR:FiLTer:TYPE(?)	Selects a filter.
[:SENSe]:Standard:ACLR:LiMit:ADJacent<x>[:STATe](?)	Determines whether to enable the adjacent limit testing.
[:SENSe]:Standard:ACLR:NCORrection(?)	Determines whether to perform the noise correction.
[:SENSe]:Standard:ACLR:SWEep(?)	Selects how to scan the 25 MHz span.
[:SENSe]:Standard:CFRequency subgroup	Related to the carrier frequency measurement.
[:SENSe]:Standard:CFRequency:CREsolutioN(?)	Sets the counter resolution.
[:SENSe]:Standard:CHPower subgroup	Related to the channel power measurement.
[:SENSe]:Standard:CHPower:BA NDwidth[:BWiDth:INTEgration(?)	Sets the channel bandwidth for the channel power measurement.
[:SENSe]:Standard:CHPower:FiLTer:COEFFicient(?)	Sets the filter roll-off rate for the channel power measurement.
[:SENSe]:Standard:CHPower:FiLTer:TYPE(?)	Selects the filter for the channel power measurement.
[:SENSe]:Standard:CHPower:LiMit[:STATe](?)	Determines whether to enable the limit testing.
[:SENSe]:Standard:EBWidth subgroup	EBW measurement related.
[:SENSe]:Standard:EBWidth:XDB(?)	Sets the relative power from the peak for the measurement.
[:SENSe]:SADLR5_3GPP:MCAClr subgroup	Related to the multi-carrier ACLR measurement.
[:SENSe]:SADLR5_3GPP:MCAClr:CA RRier[:THReShold](?)	Sets the threshold level to detect the carrier.
[:SENSe]:SADLR5_3GPP:MCAClr:FiLTer:COEFFicient(?)	Sets the filter factor (a/BT).
[:SENSe]:SADLR5_3GPP:MCAClr:FiLTer:TYPE(?)	Selects a filter.
[:SENSe]:SADLR5_3GPP:MCAClr:LiMit:ADJacent<x>[:STATe](?)	Determines whether to enable the adjacent limit testing.
[:SENSe]:SADLR5_3GPP:MCAClr:NCORrection(?)	Determines whether to perform the noise correction.
[:SENSe]:Standard:OBWidth subgroup	Related to the OBW measurement for 3GPP-R5 downlink.
[:SENSe]:Standard:OBWidth:LiMit[:STATe](?)	Determines whether to enable the limit testing.
[:SENSe]:Standard:OBWidth:PERCent(?)	Sets the occupied bandwidth for the OBW measurement.
[:SENSe]:Standard:SEMAsk subgroup	Related to the spectrum emission mask measurement.
[:SENSe]:Standard:SEMAsk:BA NDwidth[:BWiDth:INTEgration(?)	Sets the channel bandwidth for the spectrum emission mask test.
[:SENSe]:Standard:SEMAsk:FiLTer:COEFFicient(?)	Sets the filter roll-off rate.
[:SENSe]:Standard:SEMAsk:FiLTer:TYPE(?)	Selects the filter for the spectrum emission mask measurement.
[:SENSe]:Standard:SEMAsk:LiMit:ZONE<x>[:STATe](?)	Determines whether to enable the zone limit testing.
[:SENSe]:Standard:SEMAsk:RCHannel:LEVel(?)	Sets the reference channel level to measure spurious emission.
[:SENSe]:Standard:SEMAsk:RCHannel:MODE(?)	Selects the mode to define the reference channel level.
[:SENSe]:ULR5_3GPP subgroup	Related to modulation analysis for 3GPP-R5 uplink.
[:SENSe]:ULR5_3GPP:BLock(?)	Sets the number of the block to be measured.
[:SENSe]:ULR5_3GPP:CA RRier:OFFSet(?)	Sets the carrier frequency offset.
[:SENSe]:ULR5_3GPP:CA RRier:SEARch(?)	Determines whether to detect the carrier automatically.

Table 2-30: :SENSe commands (Option) (Cont.)

Header	Description
[:SENSe]:ULR5_3GPP:FILTer:ALPHa(?)	Sets the filter factor (a/BT).
[:SENSe]:ULR5_3GPP:FILTer:MEASurement(?)	Selects the measurement filter.
[:SENSe]:ULR5_3GPP:FILTer:REFerence(?)	Selects the reference filter.
[:SENSe]:ULR5_3GPP[:IMMEDIATE]	Starts 3GPP-R5 downlink analysis calculation.
[:SENSe]:ULR5_3GPP:LENGth(?)	Defines the analysis range.
[:SENSe]:ULR5_3GPP:OFFSet(?)	Sets the measurement start position.
[:SENSe]:ULR5_3GPP:SCODE:NUMBer(?)	Sets the scrambling code number.
[:SENSe]:ULR5_3GPP:SCODE:TYPE(?)	Selects or queries the scrambling code type.
[:SENSe]:ULR5_3GPP:SFRame:OFFSet:DTIME(?)	Sets the downlink time offset.
[:SENSe]:ULR5_3GPP:SFRame:OFFSet[:STSlot](?)	Sets the subframe to time-slot offset.
[:SENSe]:ULR5_3GPP:SFRame:SEARch(?)	Determines whether to detect the subframe offset automatically.
[:SENSe]:ULR5_3GPP:UANResult	Updates the ACK/NACK results.
Option 28 TD-SCDMA analysis related	
[:SENSe]:TD_SCDMA subgroup	TD-SCDMA analysis related
[:SENSe]:TD_SCDMA:BLOCK(?)	Sets or queries the number of the block to be measured.
[:SENSe]:TD_SCDMA:FILTer:MEASurement(?)	Sets the measurement filter for the current measurement.
[:SENSe]:TD_SCDMA[:IMMEDIATE]	Starts the calculation for the acquired data.
[:SENSe]:TD_SCDMA:MEASurement(?)	Sets the measurement item.
[:SENSe]:TD_SCDMA:ACLR subgroup	TD-SCDMA ACLR measurement related
[:SENSe]:TD_SCDMA:ACLR:DIRection?	Queries which limit table is used for the ACLR measurement.
[:SENSe]:TD_SCDMA:ACLR:LIMit:ADJacent<x>[:STATe](?)	Sets the enable or disable adjacent limit testing.
[:SENSe]:TD_SCDMA:ACQUISITION subgroup	Acquisition related in TD-SCDMA analysis
[:SENSe]:TD_SCDMA:ACQUISITION:HISTory(?)	Sets the acquisition history.
[:SENSe]:TD_SCDMA:ACQUISITION:SEConds(?)	Sets the acquisition length in seconds.
[:SENSe]:TD_SCDMA:ACQUISITION:SFRames(?)	Sets the acquisition length in subframes.
[:SENSe]:TD_SCDMA:ANALYSIS subgroup	Analysis related in TD-SCDMA measurements
[:SENSe]:TD_SCDMA:ANALYSIS:CHANnel:THReshold(?)	Sets the threshold for the channel measurement.
[:SENSe]:TD_SCDMA:ANALYSIS:INTerval(?)	Sets the analysis interval in chips.
[:SENSe]:TD_SCDMA:ANALYSIS:OFFSet[:CHIPs](?)	Sets the analysis offset in chips.
[:SENSe]:TD_SCDMA:ANALYSIS:OFFSet:DFRequency(?)	Sets the demod frequency offset.
[:SENSe]:TD_SCDMA:ANALYSIS:OFFSet:IQ(?)	Sets the EVM includes I/Q offset.
[:SENSe]:TD_SCDMA:ANALYSIS:REFerence:SFRame(?)	Sets the subframe reference.
[:SENSe]:TD_SCDMA:ANALYSIS:REFerence:TFFHase(?)	Sets the subframe reference.
[:SENSe]:TD_SCDMA:ANALYSIS:REFerence:TIME(?)	Sets the time reference.
[:SENSe]:TD_SCDMA:ANALYSIS:REFerence:TIME:UTSPattern(?)	Sets the timeslot pattern to be expected in the signal.

Table 2-30: :SENSe commands (Option) (Cont.)

Header	Description
[[:SENSe]:TD_SCDMA:ANALysis:TSLOT:(?)	Sets the timeslot(s) to be analyzed.
[[:SENSe]:TD_SCDMA:ANALysis:TSLOT:THReshold(?)	Sets the level to identify a timeslot as active.
[[:SENSe]:TD_SCDMA:SPECtrum subgroup	Spectrum related in TD-SCDMA measurements
[[:SENSe]:TD_SCDMA:SPECtrum:OFFSet(?)	Sets the spectrum offset within the time window.
[[:SENSe]:TD_SCDMA:SPECtrum:TINTerval(?)	Sets the length of the time domain information.
[[:SENSe]:TD_SCDMA:SElect subgroup	Selection related in TD-SCDMA measurements
[[:SENSe]:TD_SCDMA:SElect:CODE(?)	Sets the selected code.
[[:SENSe]:TD_SCDMA:SElect:SFRame(?)	Sets the selected subframe.
[[:SENSe]:TD_SCDMA:SElect:TSLOT(?)	Sets the selected timeslot.
[[:SENSe]:TD_SCDMA:MODulation subgroup	Modulation related in TD-SCDMA measurements
[[:SENSe]:TD_SCDMA:MODulation:CONTRol(?)	Sets the method used to set other modulation parameters.
[[:SENSe]:TD_SCDMA:MODulation:K:NZERo(?)	Sets the “K” for all timeslots except 0.
[[:SENSe]:TD_SCDMA:MODulation:K:ZERO(?)	Sets the “K” for timeslot 0.
[[:SENSe]:TD_SCDMA:MODulation:SCODE(?)	Sets the scrambling code.
[[:SENSe]:TD_SCDMA:MODulation:SPOint(?)	Sets the switching point between uplink and downlink timeslots.
[[:SENSe]:TD_SCDMA:MODulation:SYNC:DOWNlink(?)	Sets the Sync_DL value.
[[:SENSe]:TD_SCDMA:MODulation:SYNC:UPLink(?)	Sets the Sync_UL value.
[[:SENSe]:TD_SCDMA:CHPower subgroup	TD-SCDMA channel power measurement related
[[:SENSe]:TD_SCDMA:CHPower:BANDwidth :BWIDth:INTegration(?)	Sets the channel bandwidth for the channel power measurement.
[[:SENSe]:TD_SCDMA:CHPower:DIRection?	Queries which limit table is used for the measurement.
[[:SENSe]:TD_SCDMA:CHPower:LIMit[::STATE](?)	Sets whether to enable or disable the limit testing.
[[:SENSe]:TD_SCDMA:MACCuracy subgroup	TD-SCDMA modulation accuracy measurement related
[[:SENSe]:TD_SCDMA:MACCuracy:DIRection?	Queries which limit table is used for the measurement.
[[:SENSe]:TD_SCDMA:MACCuracy:LIMit:EVM:PEAK[::STATE](?)	Sets whether to enable the peak EVM limit testing.
[[:SENSe]:TD_SCDMA:MACCuracy:LIMit:EVM:RMS[::STATE](?)	Sets whether to enable the RMS EVM limit testing.
[[:SENSe]:TD_SCDMA:MACCuracy:LIMit:PCDerror[::STATE](?)	Sets whether to enable the peak code domain error limit testing.
[[:SENSe]:TD_SCDMA:MACCuracy:LIMit:RHO[::STATE](?)	Sets whether to enable the Rho limit testing.
[[:SENSe]:TD_SCDMA:STABle subgroup	Symbol table related in TD-SCDMA analysis
[[:SENSe]:TD_SCDMA:STABle:TPCSs:COUNT(?)	Sets the TPC and SS symbol count.
[[:SENSe]:TD_SCDMA:STABle:TPCSs:SElect(?)	Sets the TPC and SS in the Data2 burst.

Table 2-30: :SENSe commands (Option) (Cont.)

Header	Description
[:SENSe]:TD_SCDMA:IM subgroup	TD-SCDMA intermodulation measurement related
[:SENSe]:TD_SCDMA:IM:BANDwidth[:BWIDTH:INTegration(?)	Sets the bandwidth of the main channel.
[:SENSe]:TD_SCDMA:IM:DIRection?	Queries which limit table is used for the IM measurement.
[:SENSe]:TD_SCDMA:IM:LIMit:FORDER[:STATE](?)	Sets whether to enable or disable the fifth order limit testing.
[:SENSe]:TD_SCDMA:IM:LIMit:TORDER[:STATE](?)	Sets whether to enable or disable the third order limit testing.
[:SENSe]:TD_SCDMA:IM:SCOFset(?)	Sets the frequency of the second channel.
[:SENSe]:TD_SCDMA:SEMAsk subgroup	TD-SCDMA spectrum emission mask measurement related
[:SENSe]:TD_SCDMA:SEMAsk:BANDwidth[:BWIDTH:INTegration(?)	Sets the channel bandwidth.
[:SENSe]:TD_SCDMA:SEMAsk:DIRection(?)	Sets which limit table is used for the measurement
[:SENSe]:TD_SCDMA:SEMAsk:LIMit:ISpurious:ZONE<x>[:STATE](?)	Sets whether to enable or disable the offset from the inband spurious zone limit testing.
[:SENSe]:TD_SCDMA:SEMAsk:LIMit:OFChannel:ZONE<x>[:STATE](?)	Sets the enable or disable zone limit checking.
[:SENSe]:TD_SCDMA:SEMAsk:MEASurement(?)	Sets the limit table type used for limit testing.
[:SENSe]:TD_SCDMA:SEMAsk:RCHannel:MODE(?)	Sets the reference channel level mode.
[:SENSe]:TD_SCDMA:SEMAsk:RCHannel:LEVel(?)	Sets the reference channel level for measuring spurious.
[:SENSe]:TD_SCDMA:TOOMAsk subgroup	TD-SCDMA transmit on/off mask measurement related
[:SENSe]:TD_SCDMA:TOOMAsk:DIRection?	Queries which limit table is used for the measurement.
[:SENSe]:TD_SCDMA:TOOMAsk:LIMit:LEVel:ONOFF[:STATE](?)	Sets the enable or disable transmit on/off limit checking.
[:SENSe]:TD_SCDMA:TOOMAsk:LIMit:LEVel:MRAMP[:STATE](?)	Sets whether to enable the mid-ramp level limit checking.
[:SENSe]:TD_SCDMA:OBWidth Subgroup	TD-SCDMA OBW measurement related
[:SENSe]:TD_SCDMA:OBWidth:DIRection?	Queries which limit table is used for the measurement.
[:SENSe]:TD_SCDMA:OBWidth:LIMit[:STATE](?)	Sets whether to enable or disable the limit testing.
[:SENSe]:TD_SCDMA:OBWidth:PERCent(?)	Sets the occupied bandwidth.
Option 29 WLAN analysis related	
[:SENSe]:M2WLAN subgroup	IEEE802.11n MIMO (2x2) analysis related
[:SENSe]:M2WLAN:ACQuisition:HISTory(?)	Sets the acquisition history to display or reanalyze the data.
[:SENSe]:M2WLAN:ACQuisition:SEConds(?)	Sets the acquisition length in seconds.
[:SENSe]:M2WLAN:ANALysis:LENGth(?)	Sets the time length for the WLAN analysis.
[:SENSe]:M2WLAN:ANALysis:OFFSet(?)	Sets the beginning of the analysis length.
[:SENSe]:M2WLAN:ANALysis:SYNC(?)	Selects the synchronization method for the analysis.
[:SENSe]:M2WLAN:BLOCK(?)	Sets the number of the block to measure in the WLAN analysis.
[:SENSe]:M2WLAN[:IMMEDIATE]	Runs the demodulation calculation for the acquired data.
[:SENSe]:M2WLAN:MEASurement(?)	Selects the measurement item in the WLAN analysis.

Table 2-30: :SENSe commands (Option) (Cont.)

Header	Description
[:SENSe]:M2WLAN:PACKet[:NUMBer](?)	Sets the packet number to measure.
[:SENSe]:M2WLAN:SPECTrum:OFFSet(?)	Sets the spectrum offset within the acquisition length.
[:SENSe]:M2WLAN:SSEGment[:NUMBer](?)	Sets the symbol number or segment number.
[:SENSe]:M2WLAN:SUBCarrier[:NUMBer](?)	Sets the subcarrier number.
[:SENSe]:M2WLAN:SUBCarrier:SElect(?)	Selects the subcarrier(s) to display.
[:SENSe]:M2WLAN:TXAntenna:SElect(?)	Selects the transmitting antenna to display measurement results.
[:SENSe]:SWLAN subgroup	IEEE802.11n (nx1) analysis related
[:SENSe]:SWLAN:ACQuisition:HISTory(?)	Sets the acquisition history to display or reanalyze the data.
[:SENSe]:SWLAN:ACQuisition:SEConds(?)	Sets the acquisition length in seconds.
[:SENSe]:SWLAN:ANALysis:EQualization[:STATe](?)	Determines whether to enable the data correction.
[:SENSe]:SWLAN:ANALysis:LENGth(?)	Sets the time length for the WLAN analysis.
[:SENSe]:SWLAN:ANALysis:OFFSet(?)	Sets the beginning of the analysis length.
[:SENSe]:SWLAN:ANALysis:SFORmat(?)	Selects the signal format.
[:SENSe]:SWLAN:ANALysis:SYNC(?)	Selects the synchronization method for the analysis.
[:SENSe]:SWLAN:BLOCK(?)	Sets the number of the block to measure in the WLAN analysis.
[:SENSe]:SWLAN[:IMMediate]	Runs the demodulation calculation for the acquired data.
[:SENSe]:SWLAN:MEASurement(?)	Selects the measurement item in the WLAN analysis.
[:SENSe]:SWLAN:PACKet[:NUMBer](?)	Sets the packet number to measure.
[:SENSe]:SWLAN:SMASK[:SElect](?)	Selects the transmit spectral mask specified in 802.11n.
[:SENSe]:SWLAN:SPECTrum:OFFSet(?)	Sets the spectrum offset within the acquisition length.
[:SENSe]:SWLAN:SSEGment[:NUMBer](?)	Sets the symbol number or segment number.
[:SENSe]:SWLAN:SUBCarrier[:NUMBer](?)	Sets the subcarrier number.
[:SENSe]:SWLAN:SUBCarrier:SElect(?)	Selects the subcarrier(s) to display.
[:SENSe]:SWLAN:TXAntenna:SElect(?)	Selects the transmitting antenna to display measurement results.
[:SENSe]:WLAN subgroup	WLAN analysis related
[:SENSe]:WLAN:ACQuisition:HISTory(?)	Sets the acquisition history to display or reanalyze the data.
[:SENSe]:WLAN:ACQuisition:SEConds(?)	Sets the acquisition length in seconds.
[:SENSe]:WLAN:ANALysis:EQualization[:STATe](?)	Determines whether to enable the data correction.
[:SENSe]:WLAN:ANALysis:LENGth(?)	Sets the time length for the WLAN analysis.
[:SENSe]:WLAN:ANALysis:MODulation(?)	Sets the modulation type for analysis.
[:SENSe]:WLAN:ANALysis:OFFSet(?)	Sets the beginning of the analysis length.
[:SENSe]:WLAN:ANALysis:SYNC(?)	Selects the synchronization function for the long training symbol.
[:SENSe]:WLAN:BLOCK(?)	Sets the number of the block to measure in the WLAN analysis.
[:SENSe]:WLAN[:IMMediate]	Runs the demodulation calculation for the acquired data.
[:SENSe]:WLAN:MEASurement(?)	Selects the measurement item in the WLAN analysis.

Table 2-30: :SENSe commands (Option) (Cont.)

Header	Description
[[:SENSe]:WLAN:SMASK[:SElect](?)	Selects the signal type for the spectrum mask measurement.
[[:SENSe]:WLAN:SPECTrum:OFFSet(?)	Sets the spectrum offset within the acquisition length.
[[:SENSe]:WLAN:SSEGment[:NUMBer](?)	Sets the symbol number or segment number.
[[:SENSe]:WLAN:SUBCarrier[:NUMBer](?)	Sets the subcarrier number.
[[:SENSe]:WLAN:SUBCarrier:SElect(?)	Selects the subcarrier(s) to display.
[[:SENSe]:WLAN:TPOWer:BURSt:INDex(?)	Sets the burst index for the transmit power measurement.
[[:SENSe]:WLAN:TPOWer:SLOPe(?)	Selects the transmit power ramp.
Option 40 3GPP-R6 analysis related	
[[:SENSe]:DLR6_3GPP subgroup	Related to modulation analysis for 3GPP-R6 downlink
[[:SENSe]:DLR6_3GPP:BLOCK(?)	Sets the number of the block to measure.
[[:SENSe]:DLR6_3GPP:CARRier:OFFSet(?)	Sets the carrier frequency offset.
[[:SENSe]:DLR6_3GPP:CARRier:SEARch(?)	Determines whether to detect the carrier automatically.
[[:SENSe]:DLR6_3GPP:CCODE:EAGCh(?)	Sets the channelization code number of E-AGCH.
[[:SENSe]:DLR6_3GPP:CCODE:ERGCh(?)	Sets the channelization code number of E-RGCH and E-HICH.
[[:SENSe]:DLR6_3GPP:COMPOSITE(?)	Determines whether to perform the composite analysis.
[[:SENSe]:DLR6_3GPP:DTYPE:SEARch(?)	Sets whether to detect the demodulation type of code channel.
[[:SENSe]:DLR6_3GPP:EVM:IQOffset(?)	Determines whether to include the I/Q origin offset in the analysis.
[[:SENSe]:DLR6_3GPP:FILTer:ALPHA(?)	Sets the filter factor.
[[:SENSe]:DLR6_3GPP:FILTer:MEASurement(?)	Selects the measurement filter.
[[:SENSe]:DLR6_3GPP:FILTer:REFerence(?)	Selects the reference filter.
[[:SENSe]:DLR6_3GPP:IMMEDIATE]	Runs the downlink analysis calculation on the acquired data.
[[:SENSe]:DLR6_3GPP:LENGth(?)	Defines the analysis range.
[[:SENSe]:DLR6_3GPP:OFFSet(?)	Sets the measurement start position.
[[:SENSe]:DLR6_3GPP:SCHPart(?)	Determines whether to include the SCH part in the analysis.
[[:SENSe]:DLR6_3GPP:SCODE:ALTerNative(?)	Selects the alternative scrambling code.
[[:SENSe]:DLR6_3GPP:SCODE:NUMBer(?)	Sets the scrambling code.
[[:SENSe]:DLR6_3GPP:SCODE:SEARch(?)	Determines whether to detect the scrambling code automatically.
[[:SENSe]:DLR6_3GPP:SSINDEX:EAGCh(?)	Sets the signature sequence index number of E-HICH.
[[:SENSe]:DLR6_3GPP:SSINDEX:ERGCh(?)	Sets the signature sequence index number of E-RGCH.
[[:SENSe]:DLR6_3GPP:UTSTable	Updates the time-slot table.

Table 2-30: :SENSe commands (Option) (Cont.)

Header	Description
[:SENSe]:ULR6_3GPP subgroup	Related to modulation analysis for 3GPP-R6 uplink.
[:SENSe]:ULR6_3GPP:BLOCK(?)	Sets the number of the block to be measured.
[:SENSe]:ULR6_3GPP:CARRier:OFFSet(?)	Sets the carrier frequency offset.
[:SENSe]:ULR6_3GPP:CARRier:SEARch(?)	Determines whether to detect the carrier automatically.
[:SENSe]:ULR6_3GPP:CCONfig(?)	Selects the channel configuration.
[:SENSe]:ULR6_3GPP:DFORmat(?)	Selects the DPCCH format to decode TFCl.
[:SENSe]:ULR6_3GPP:EVM:IQOoffset(?)	Determines whether to include the I/Q origin offset in calculation.
[:SENSe]:ULR6_3GPP:EVM:TPERiods(?)	Determines whether to include the transient periods in calculation.
[:SENSe]:ULR6_3GPP:FILTer:ALPHa(?)	Sets the filter factor (a/BT).
[:SENSe]:ULR6_3GPP:FILTer:MEASurement(?)	Selects the measurement filter.
[:SENSe]:ULR6_3GPP:FILTer:REFerence(?)	Selects the reference filter.
[:SENSe]:ULR6_3GPP[:IMMediate]	Starts 3GPP-R6 downlink analysis calculation.
[:SENSe]:ULR6_3GPP:LENGth(?)	Defines the analysis range.
[:SENSe]:ULR6_3GPP:OFFSet(?)	Sets the measurement start position.
[:SENSe]:ULR6_3GPP:SCODE:NUMBer(?)	Sets the scrambling code number.
[:SENSe]:ULR6_3GPP:SCODE:TYPE(?)	Selects or queries the scrambling code type.
[:SENSe]:ULR6_3GPP:SFRame:OFFSet:DTIME(?)	Sets the downlink time offset.
[:SENSe]:ULR6_3GPP:SFRame:OFFSet[:STSlot](?)	Sets the subframe to time-slot offset.
[:SENSe]:ULR6_3GPP:SFRame:SEARch(?)	Determines whether to detect the subframe offset automatically.
[:SENSe]:ULR6_3GPP:SFRame:TOLerance(?)	Sets the tolerance for decoding HS-DPCCH and E-DPCCH.
[:SENSe]:ULR6_3GPP:THReshold[:BURSt](?)	Sets the threshold level to detect a burst.
[:SENSe]:ULR6_3GPP:THReshold:DTX(?)	Sets the threshold level to detect the DTX state.
[:SENSe]:ULR6_3GPP:UTSTable	Updates the time-slot table.

:STATus Commands

Control registers defined in the SCPI status reporting structure.

Table 2-31: :STATus commands

Header	Description
:STATus:OPERation:CONDition?	Queries the contents of the OCR.
:STATus:OPERation:ENABLE(?)	Sets the mask for the OENR.
:STATus:OPERation[:EVENT]?	Queries the contents of the OEVR.
:STATus:OPERation:NTRansition(?)	Sets the value of the negative transition filter.
:STATus:OPERation:PTRansition(?)	Sets the value of the positive transition filter.
:STATus:PRESet	Presets a status byte.
:STATus:QUEStionable:CONDition?	Queries the contents of the QCR.
:STATus:QUEStionable:ENABLE(?)	Sets the mask for the OENR.
:STATus:QUEStionable[:EVENT]?	Queries the contents of the QER.
:STATus:QUEStionable:NTRansition(?)	Sets the value of the negative transition filter.
:STATus:QUEStionable:PTRansition(?)	Sets the value of the positive transition filter.

:SYSTem Commands

Set the system parameters and query system information.

Table 2-32: :SYSTem commands

Header	Description
:SYSTem:DATE(?)	Sets the current date.
:SYSTem:ERRor:ALL?	Queries all the error or event information.
:SYSTem:ERRor:CODE:ALL?	Queries all the error or event codes.
:SYSTem:ERRor:CODE[:NEXT]?	Queries the latest error or event codes.
:SYSTem:ERRor:COUNT?	Queries the number of errors or events.
:SYSTem:ERRor[:NEXT]?	Queries the latest error or event information.
:SYSTem:KLOCK(?)	Determine whether to lock or unlock the front panel keys.
:SYSTem:OPTions?	Queries optional information.
:SYSTem:PRESet	Presets the analyzer.
:SYSTem:TIME(?)	Sets the current time.
:SYSTem:VERSion?	Queries the version of the SCPI.

:TRACe Commands

Set up display of Trace 1 and 2.

Table 2-33: :TRACe commands

Header	Description
:TRACe<x>:DATA<x>:AVERAge:CLEAr	Restarts trace averaging.
:TRACe<x>:DATA<x>:AVERAge:COUNT(?)	Sets the number of traces to combine for averaging.
:TRACe<x>:DATA<x>:DDETEctor(?)	Selects the display detector.
:TRACe<x>:DATA<x>:MODE(?)	Selects the way to display the traces.
:TRACe2:DATA2:MODE(?) (Option 21 only)	Selects how to display Trace 2 in the signal source analysis.

:TRIGger Commands

Set up the trigger.

Table 2-34: :TRIGger commands

Header	Description
:TRIGger[:SEQuence]:LEVel:EXTernal(?)	Sets the external trigger level.
:TRIGger[:SEQuence]:LEVel:IQFRequency(?)	Sets the IQ frequency trigger level (Option 02 only).
:TRIGger[:SEQuence]:LEVel:IQTime(?)	Sets the IQ time trigger level.
:TRIGger[:SEQuence]:MODE(?)	Selects the trigger mode.
:TRIGger[:SEQuence]:MPOStion?	Queries the trigger occurrence point in one block data on the memory.
:TRIGger[:SEQuence]:OPOStion?	Queries the trigger output point.
:TRIGger[:SEQuence]:POStion(?)	Sets the trigger position.
:TRIGger[:SEQuence]:SAVE:COUNT[:STATe](?)	Determines whether to limit the number of times that data is saved.
:TRIGger[:SEQuence]:SAVE:COUNT:MAXimum(?)	Sets a limit on the number of times that data is saved.
:TRIGger[:SEQuence]:SAVE[:STATe](?)	Determines whether to enable or disable the Save-on-Trigger function.
:TRIGger[:SEQuence]:SLOPe(?)	Selects the trigger slope.
:TRIGger[:SEQuence]:SOURce(?)	Selects the trigger source.

:UNIT Commands

Specify fundamental units for measurement.

Table 2-35: :UNIT commands

Header	Description
:UNIT:ANGLE(?)	Specifies the fundamental unit of angle.

IEEE Common Commands

This section details the IEEE common commands.

Command Tree

Header	Parameter
*CAL?	
*CLS	
*ESE	<value>
*ESR?	
*IDN?	
*OPC	
*OPT?	
*RST	
*SRE	<value>
*STB?	
*TRG	
*TST?	
*WAI	

***CAL? (Query Only)**

Runs the following three calibrations and returns the results indicating whether they have ended normally.

RF gain calibration
Center offset calibration
DC offset calibration (if the measurement frequency band is the baseband)

This command is equivalent to the :CALibration[:ALL]? query command.

NOTE. *The entire calibration process takes several minutes to several dozen minutes. Wait for a response from a *CAL query. Every command you attempt to send during this period is rejected.*

Syntax	*CAL?
Arguments	None
Returns	<NR1> 0 indicates a normal end. For details of the error codes, refer to page 3-17.
Measurement Modes	All
Examples	*CAL? runs a calibration and might return 0, indicating that the calibration has ended normally.
Related Commands	:CALibration[:ALL]

***CLS (No Query Form)**

Clears all the event status registers and queues used in the status/event reporting structure. Refer to Section 3, *Status and Events*, for the register information.

Syntax *CLS

Arguments None

Measurement Modes All

Examples *CLS
clears all the event status registers and queues.

Related Commands *ESE, *ESR, *SRE, *STB?

***ESE(?)**

Sets or queries the value of the Event Status Enable Register (ESER) used in the status/event reporting structure. Refer to Section 3, *Status and Events*, for the register information.

Syntax *ESE <value>

*ESE?

Arguments <value>::=<NR1> is a value in the range from 0 through 255. The binary bits of the ESER are set according to this value.

Measurement Modes All

Examples *ESE 145
sets the ESER to binary 10010001, which enables the PON, EXE, and OPC bits.

*ESE?
might return the string *ESE 184, showing that the ESER contains the binary value 10111000.

Related Commands *CLS, *ESR, *SRE, *STB?

***ESR? (Query Only)**

Sets or queries the contents of the Standard Event Status Register (SESR) used in the status/event reporting structure. The SESR is cleared after being read. Refer to Section 3, *Status and Events*, for the register information.

Syntax *ESR?

Arguments None

Returns <NR1> representing the contents of the SESR by a 0 to 255 decimal number.

Measurement Modes All

Examples *ESR?
might return the value 213, showing that the SESR contains binary 11010101.

Related Commands *CLS, *ESE?, *SRE, *STB?

***IDN? (Query Only)**

Returns the analyzer identification code.

Syntax *IDN?

Arguments None

Returns The analyzer identification code in the following format:

TEKTRONIX,RSA3408A,<serial_number>,<firmware_version>

Where

TEKTRONIX indicates that the manufacturer is Tektronix.

<serial_number> is the serial number.

<firmware_version> is the firmware version.

Measurement Modes All

Examples *IDN?
might return TEKTRONIX,RSA3408A,B300101,3.10.000 as the analyzer identification code.

***OPC(?)**

Generates the operation complete message in the Standard Event Status Register (SESR) when all pending operations finish. The *OPC? query places the ASCII character “1” into the output queue when all pending operations are finished. The *OPC? response is not available to read until all pending operations finish.

The *OPC command allows you to synchronize the operation of the analyzer with your application program. Refer to *Synchronizing Execution* on page 3-14 for details.

Syntax *OPC

*OPC?

Arguments None

Measurement Modes All

***OPT? (Query Only)**

Queries the options installed in the analyzer.

Syntax *OPT?

Arguments None

Returns The numbers of all the options installed in the analyzer, separated by commas. If no options have been installed, 0 is returned.

Measurement Modes All

Examples *OPT?
might return 02,03,21, indicating that Option 02, 03, and 21 are currently installed in the analyzer.

*RST (No Query Form)

Restores the analyzer to the factory default settings. For the actual settings, refer to *Appendix C: Factory Initialization Settings*. This command is equivalent to a pair of commands :SYSTem:PRESet and *CLS that run successively.

The *RST command does not alter the following:

- The state of the IEEE Std 488.1-1987 interface.
- The selected IEEE Std 488.1-1987 address of the analyzer.
- Measurement mode selected with the :INSTrument[:SElect] command
- Calibration data that affect device specifications.
- The Output Queue.
- The Service Request Enable Register setting.
- The Standard Event Status Enable Register setting.
- The Power-on status clear flag setting.
- Stored settings.

Syntax *RST

Arguments None

Measurement Modes All

Examples *RST
resets the analyzer.

Related Commands *CLS, :INSTrument[:SElect], :SYSTem:PRESet

***SRE(?)**

Sets or queries the value of the Service Request Enable Register (SRER) used in the status/event reporting structure. Refer to Section 3, *Status and Events*, for the register information.

Syntax *SRE <value>
*SRE?

Arguments <value>: :=<NR1> is a value in the range from 0 to 255. The binary bits of the SRER are set according to this value. Using an out-of-range value causes an execution error.

Measurement Modes All

Examples *SRE 48
sets binary 00110000 in the SRER's bits:

*SRE?
might return 32, indicating that binary value 00100000 has been set in the SRER's bits.

Related Commands *CLS, *ESE, *ESR?, *STB?

*STB? (Query Only)

Returns the contents of the Status Byte Register (SBR) in the status/event reporting structure using the Master Summary Status (MSS) bit. Refer to Section 3, *Status and Events*, for the register information.

Syntax	*STB?
Arguments	None
Returns	<NR1> representing the contents of the SBR as a decimal number.
Measurement Modes	All
Examples	*STB? might return 96, indicating that the SBR contains binary 0110 0000.
Related Commands	*CLS, *ESE, *ESR?, *SRE

*TRG (No Query Form)

Generates a trigger signal.
This command is equivalent to the :INITiate[:IMMediate] command.

Syntax	*TRG
Arguments	None
Measurement Modes	All
Examples	*TRG generates a trigger signal.
Related Commands	:INITiate[:IMMediate]

***TST? (Query Only)**

Runs a self test and returns the result.

NOTE. *The analyzer does not run any self test. It returns 0 whenever a *TST command is sent.*

Syntax	*TST?
Arguments	None
Returns	<NR1>. Always 0.
Measurement Modes	All
Related Commands	*CAL?, CALibration[:ALL]

***WAI (No Query Form)**

Prevents the analyzer from executing further commands or queries until all pending operations finish. This command allows you to synchronize the operation of the analyzer with your application program. For details, refer to *Synchronizing Execution* on page 3-14.

Syntax	*WAI
Arguments	None
Measurement Modes	All
Related Commands	*OPC

:ABORt Commands

Resets the trigger system and related actions such as data acquisition and measurement.

Command Tree

Header	Parameter
:ABORt	

:ABORt (No Query Form)

Resets the trigger system and related actions such as data acquisition and measurement.

NOTE. *You must have acquired data using the :INITiate:CONTInuous command (refer to page 2-872) before you can execute the :ABORt command.*

The command function depends on the acquisition mode as follows.

For single acquisition mode:

The :ABORt command forcibly stops data acquisition.

To stop the acquisition because the trigger does not occur in the single mode, send this command:

```
:INITiate:CONTInuous OFF
```

For continuous acquisition mode:

The :ABORt command initiates a new session of data acquisition in the continuous mode.

To stop the acquisition in the continuous mode, send this command:

```
:INITiate:CONTInuous OFF
```

Syntax	:ABORt
Arguments	None
Measurement Modes	All
Examples	:ABORt resets the trigger system and related actions such as data acquisition and measurement.
Related Commands	:INITiate:CONTInuous

:CALCulate Commands

The :CALCulate commands control the marker and the display line. The views are identified with :CALCulate<x> in the command header (see Figure 2-5).

- :CALCulate1: View 1
- :CALCulate2: View 2 (NOTE: currently not used)
- :CALCulate3: View 3
- :CALCulate4: View 4

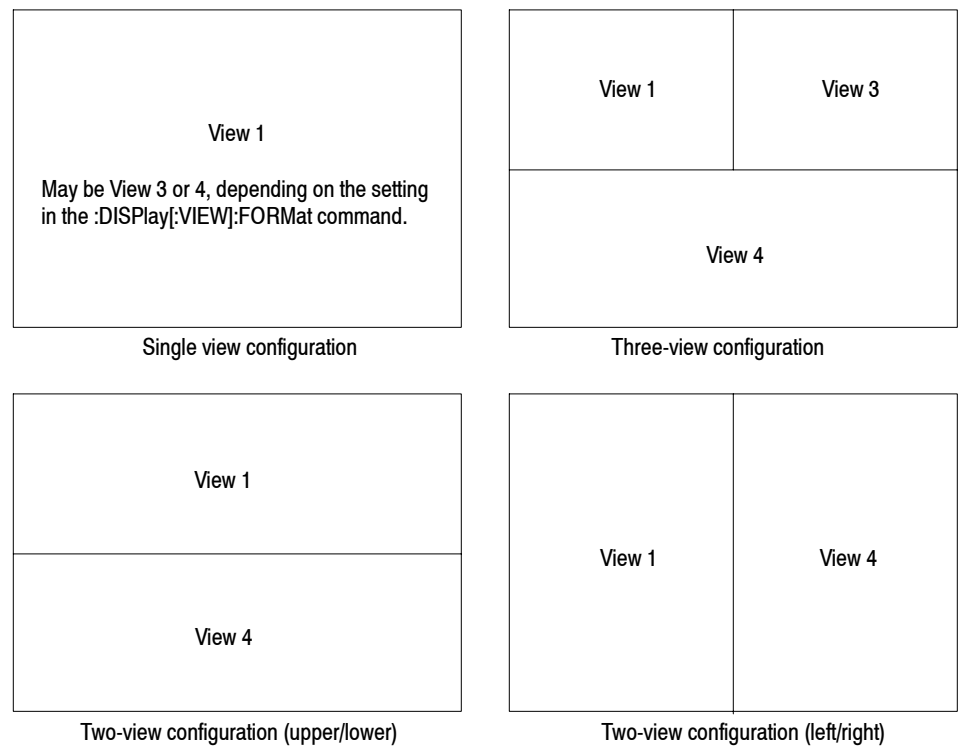

Figure 2-5: View number assignments

For details on the marker and the display line, refer to the *RSA3408A User Manual*.

Command Tree

Header	Parameter
:CALCulate<x>	
:DLINe<y>	<numeric_value>
:STATe	<boolean>
:MARKer<y>	
:AOFF	
:MAXimum	
:MODE	POSition DELTa
:PEAK	
:HIGHer	
:LEFT	
:LOWer	
:RIGHT	
:PTHReshold	<numeric_value>
:ROFF	
[:SET]	
:CENTer	
:MEASurement	
:RCURsor	
[:STATe]	<boolean>
:T	<numeric_value>
:TOGGle	
:TRACe	MAIN SUB
:X	<numeric_value>
:Y	<numeric_value>
:VLINe<y>	<numeric_value>
:STATe	<boolean>

:CALCulate<x>:DLINe<y>(?)

Sets or queries the vertical position of the horizontal line.

Syntax :CALCulate<x>:DLINe<y> <value>
:CALCulate<x>:DLINe<y>?

Arguments <value>::=<NRf> specifies the vertical position of the horizontal line.
Range: -200 to +100 dBm

Measurement Modes All S/A modes

Examples :CALCulate1:DLINe1 -20
positions Horizontal Line 1 at -20 dBm in View 1.

Related Commands :CALCulate<x>:DLINe<y>:STATe

:CALCulate<x>:DLINe<y>:STATe(?)

Determines whether to turn on or off the horizontal line.

Syntax :CALCulate<x>:DLINe<y>:STATe { OFF | ON | 0 | 1 }
:CALCulate<x>:DLINe<y>:STATe?

Arguments OFF or 0 hides the horizontal line.
ON or 1 shows the horizontal line.

Measurement Modes All S/A modes

Examples :CALCulate1:DLINe2:STATe 1
shows Horizontal Line 2 in View 1.

:CALCulate<x>:MARKer<y>:AOFF (No Query Form)

Turns off all the markers of all the traces in the specified view.

Syntax :CALCulate<x>:MARKer<y>:AOFF

Arguments None

Measurement Modes All

Examples :CALCulate1:MARKer1:AOFF
turns off all the markers of all the traces in View 1.

:CALCulate<x>:MARKer<y>:MAXimum (No Query Form)

Positions the marker at the maximum point on the trace in the specified view.

Syntax :CALCulate<x>:MARKer<y>:MAXimum

Arguments None

Measurement Modes All

Examples :CALCulate1:MARKer1:MAXimum
positions the marker at the maximum point on the trace in View 1.

:CALCulate<x>:MARKer<y>:MODE(?)

Selects or queries the marker mode (position or delta) in the specified view.

Syntax :CALCulate<x>:MARKer<y>:MODE { POSition | DELTa }
:CALCulate<x>:MARKer<y>:MODE?

Arguments POSition selects the position marker mode, in which the marker measurement is performed without the reference cursor. It works the same for both <y>=1 and 2.
DELTA selects the delta marker mode, in which the marker measurement is performed with the reference cursor. The reference cursor is placed at the position of the specified marker.

Measurement Modes All

Examples :CALCulate1:MARKer1:MODE DELTa
selects the delta marker mode in View 1.

:CALCulate<x>:MARKer<y>:PEAK:HIGHer (No Query Form)

Moves the marker higher in amplitude to the next peak in the specified view.

Syntax :CALCulate<x>:MARKer<y>:PEAK:HIGHer

Arguments None

Returns If no peak exists, the error message “No Peak Found Error (202)” is returned.

Measurement Modes All

Examples :CALCulate1:MARKer1:PEAK:HIGHer
moves Marker 1 higher in amplitude to the next peak in View 1.

:CALCulate<x>:MARKer<y>:PEAK:LEFT (No Query Form)

Shifts the marker to the next peak on the left in the specified view.

Syntax :CALCulate<x>:MARKer<y>:PEAK:LEFT

Arguments None

Returns If no peak exists, the error message “No Peak Found Error (202)” is returned.

Measurement Modes All

Examples :CALCulate1:MARKer1:PEAK:LEFT
shifts the marker to the next peak on the left in View 1.

:CALCulate<x>:MARKer<y>:PEAK:LOWer (No Query Form)

Moves the marker lower in amplitude to the next peak in the specified view.

Syntax :CALCulate<x>:MARKer<y>:PEAK:LOWer

Arguments None

Returns If no peak exists, error message “No Peak Found Error (202)” is returned.

Measurement Modes All

Examples :CALCulate1:MARKer1:PEAK:LOWer
moves Marker 1 lower in amplitude to the next peak in View 1.

:CALCulate<x>:MARKer<y>:PEAK:RIGHt (No Query Form)

Shifts the marker to the next peak on the right in the specified view.

Syntax :CALCulate<x>:MARKer<y>:PEAK:RIGHt

Arguments None

Returns If no peak exists, the error message “No Peak Found Error (202)” is returned.

Measurement Modes All

Examples :CALCulate1:MARKer1:PEAK:RIGHt
shifts the marker to the next peak on the right in View 1.

:CALCulate<x>:MARKer<y>:PTHReshold(?)

Sets or queries the horizontal minimum jump of the marker for peak search in the specified view.

Syntax :CALCulate<x>:MARKer<y>:PTHReshold <value>
:CALCulate<x>:MARKer<y>:PTHReshold?

Arguments <value>::=<NRf> sets the minimum jump of the marker for peak search.
Range: 1% to 20% of the span setting.

Measurement Modes All

Examples :CALCulate1:MARKer1:PTHReshold 10kHz
sets the minimum jump of Marker 1 to 10 kHz for peak search.

:CALCulate<x>:MARKer<y>:ROFF (No Query Form)

Turns off the reference cursor in the specified view.

Syntax :CALCulate<x>:MARKer<y>:ROFF

Arguments None

Measurement Modes All

Examples :CALCulate1:MARKer1:ROFF
turns off the reference cursor in View 1.

Related Commands :CALCulate<x>:MARKer<y>[:SET]:RCURsor

:CALCulate<x>:MARKer<y>[:SET]:CENTer (No Query Form)

Sets the center frequency to the value at the marker position in the specified view.

Syntax :CALCulate<x>:MARKer<y>[:SET]:CENTer

Arguments None

Measurement Modes All S/A modes

Examples :CALCulate1:MARKer1:SET:CENTer
sets the center frequency to the value at the marker position in View 1.

:CALCulate<x>:MARKer<y>[:SET]:MEASurement (No Query Form)

Defines the measurement position using the marker(s) in the specified view.

NOTE. This command is available in a view that represents time along the horizontal axis.

The function varies between the marker modes as follows:

- *For the position marker mode:*
Sets the current position of the specified marker to the measurement start position.
- *For the delta marker mode:*
Sets the current positions of the specified marker and the reference cursor to the measurement start and stop positions.

The marker mode is selected with the :CALCulate<x>:MARKer<y>:MODE command (refer to page 2-95).

Syntax :CALCulate<x>:MARKer<y>[:SET]:MEASurement

Arguments None

Measurement Modes All Demod modes, all Time modes

Examples :CALCulate1:MARKer1:SET:MEASurement
defines the measurement position using the marker in View 1.

Related Commands :CALCulate<x>:MARKer<y>:MODE

:CALCulate<x>:MARKer<y>[:SET]:RCURsor (No Query Form)

Displays the reference cursor at the marker position in the specified view.

Syntax :CALCulate<x>:MARKer<y>[:SET]:RCURsor

Arguments None

Measurement Modes All

Examples :CALCulate1:MARKer1:SET:RCURsor
displays the reference cursor in View 1.

Related Commands :CALCulate<x>:MARKer<y>:ROFF

:CALCulate<x>:MARKer<y>[:STATe](?)

Determines whether to turn on or off the marker(s) in the specified view.

Syntax :CALCulate<x>:MARKer<y>[:STATe] { OFF | ON | 0 | 1 }
:CALCulate<x>:MARKer<y>[:STATe]?

Arguments OFF or 0 hides the marker(s). If you have selected the delta marker mode, both the main and delta markers will be turned off.

ON or 1 shows the marker(s). If you have selected the delta marker mode, both the main and delta markers will be turned on.

To select a marker mode, use :CALCulate<x>:MARKer<y>:MODE.

Measurement Modes All

Examples :CALCulate1:MARKer1:STATe ON
enables Marker 1 in View 1.

Related Commands :CALCulate<x>:MARKer<y>:MODE

:CALCulate<x>:MARKer<y>:T(?)

Sets or queries the time position of the marker in the specified view.

NOTE. *This command is valid in the eye diagram and the constellation view.*

Syntax :CALCulate<x>:MARKer<y>:T <time>
:CALCulate<x>:MARKer<y>:T?

Arguments <time>::=<Nrf> sets the time position of the marker in seconds.
For the setting range, refer to Table D-1 in *Appendix D*.

Measurement Modes All Demod modes except DEMADEM

Examples :CALCulate4:MARKer1:T -1.5ms
places Marker 1 at -1.5 ms in View 4 of the eye diagram.

:CALCulate<x>:MARKer<y>:TOGGle (No Query Form)

Replaces the marker and the reference cursor with each other in the specified view.

Syntax :CALCulate<x>:MARKer<y>:TOGGle

Arguments None

Measurement Modes All

Examples :CALCulate1:MARKer1:TOGGle
replaces Marker 1 and the reference cursor with each other in View 1.

:CALCulate<x>:MARKer<y>:TRACe(?)

Selects the trace to place the marker in the specified view.

The query command returns the name of the trace on which the marker is currently placed.

Syntax :CALCulate<x>:MARKer<y>:TRACe { MAIN | SUB }

:CALCulate<x>:MARKer<y>:TRACe?

Arguments MAIN places the specified marker on Trace 1 (displayed in yellow on screen).

SUB places the specified marker on Trace 2 (displayed in green on screen).

Measurement Modes All

Examples :CALCulate1:MARKer1:TRACe SUB
places Marker 1 on Trace 2 in View 1.

:CALCulate<x>:MARKer<y>:X(?)

Sets or queries the horizontal position of the marker in the specified view.

NOTE. For the eye diagram or the constellation view, only query is available. For the constellation view, the returned value means an amplitude.

Syntax :CALCulate<x>:MARKer<y>:X <param>
:CALCulate<x>:MARKer<y>:X?

Arguments <param>::=<NRf> specifies the horizontal marker position.

The parameter value is different between the marker modes as follows:

- *For the position marker mode:*
Sets the absolute position of the specified marker.
- *For the delta marker mode:*
Sets the relative position of the specified marker from the reference cursor.

The marker mode is selected with the :CALCulate<x>:MARKer<y>:MODE command (refer to page 2-95).

The valid setting range depends on the display format. Refer to Table D-1 in *Appendix D*.

Measurement Modes All

Examples :CALCulate1:MARKer1:X 800MHz
places Marker 1 at 800 MHz in View 1 when the horizontal axis represents frequency.

Related Commands :CALCulate<x>:MARKer<y>:MODE

:CALCulate<x>:MARKer<y>:Y(?)

Sets or queries the vertical position of the marker in the specified view.

NOTE. The setting command is valid in the spectrogram view displayed in the Real Time S/A (real-time spectrum analysis) mode and in the overview of the Demod (modulation analysis) and the Time (time analysis) modes. If the command is executed in other views, the error message “Execution Error” (-200) is returned.

The query is available in all views. For the constellation view, the returned value means a phase.

Syntax :CALCulate<x>:MARKer<y>:Y <param>

:CALCulate<x>:MARKer<y>:Y?

Arguments <param>::=<NRf> specifies the vertical marker position.

The parameter value is different between the marker modes as follows:

- *For the position marker mode:*
Sets the absolute position of the specified marker.
- *For the delta marker mode:*
Sets the relative position of the specified marker from the reference cursor.

The marker mode is selected with the :CALCulate<x>:MARKer<y>:MODE command (refer to page 2-95).

For the setting range, refer to Table D-1 in *Appendix D*.

Measurement Modes SARTIME, all Demod modes, and all Time modes for setting.
All modes for query.

Examples :CALCulate1:MARKer1:Y -20
places the first marker at frame #-20 in View 1 (spectrogram).

:CALCulate2:MARKer1:Y?
might return -34.28 indicating the first marker readout is -34.28 dBm in View 2 (spectrum).

Related Commands :CALCulate<x>:MARKer<y>:MODE

:CALCulate<x>:VLINE<y>(?)

Sets or queries the horizontal position of the vertical line.

Syntax :CALCulate<x>:VLINE<y> <value>
:CALCulate<x>:VLINE<y>?

Arguments <value>::=<NRf> specifies the horizontal position of the vertical line.
Range: 0 Hz to 8 GHz

Measurement Modes All S/A modes

Examples :CALCulate1:VLINE1 800MHz
sets the horizontal position of Vertical Line 1 to 800 MHz.

Related Commands :CALCulate<x>:VLINE<y>:STATe

:CALCulate<x>:VLINE<y>:STATe(?)

Determines whether to turn on or off the vertical line.

Syntax :CALCulate<x>:VLINE<y>:STATe { OFF | ON | 0 | 1 }
:CALCulate<x>:VLINE<y>:STATe?

Arguments OFF or 0 hides the vertical line.
ON or 1 shows the vertical line.

Measurement Modes All S/A modes

Examples :CALCulate1:VLINE1:STATe ON
shows Vertical Line 1 in View 1.

:CALibration Commands

The :CALibration commands run calibration routines or get correction factors on the analyzer. For details on calibrations, refer to the *RSA3408A User Manual*.

Command Tree

Header	Parameter
:CALibration	
[:ALL]	
:AUTO	
:DATA	
:DEFault	
:FLATness	
:IF	
:IQ	
:CORRection	
:MAGNitude?	
:PHASe?	
:HEADer?	
:VFRame	
:BNUMber	<numeric_value>
[:TYPE]	ALL BLOCK
:OFFSet	
:BASEbanddc	
:CENTer	
:IQINput (Option 03 only)	
:RF	

:CALibration[:ALL](?)

Runs the following four calibrations:

- Gain calibration
- Center offset calibration
- IF flatness calibration
- DC offset calibration (if the measurement frequency band is the baseband)

The :CALibration[:ALL]? query command runs these calibrations and returns the results. This command is equivalent to the *CAL? query command.

Syntax :CALibration[:ALL]
:CALibration[:ALL]?

Arguments None

Returns <NR1>
0 indicates a normal end. For details of the error codes, refer to page 3-17.

Measurement Modes All

Examples :CALibration:ALL
runs all calibrations.

Related Commands *CAL?

:CALibration:AUTO(?)

Determines whether to run the RF gain calibration automatically.

Syntax :CALibration:AUTO { OFF | ON | 0 | 1 }
:CALibration:AUTO?

Arguments OFF or 0 specifies that the analyzer does not run the RF gain calibration automatically. Use the :CALibration:RF command to run the RF gain calibration.

ON or 1 specifies that the analyzer runs the RF gain calibration automatically.

Measurement Modes All

Examples :CALibration:AUTO ON
specifies that the analyzer runs the RF gain calibration automatically.

Related Commands :CALibration:RF

:CALibration:DATA:DEFault (No Query Form)

Restores the calibration data to the factory defaults.

Syntax :CALibration:DATA:DEFault

Arguments None

Measurement Modes All

Examples :CALibration:DATA:DEFault
restores the calibration data to the factory defaults.

:CALibration:FLATness:IF(?)

Runs the IF Flatness calibration. The query version of this command runs the calibration and, if it ends normally, returns 0.

Syntax :CALibration:FLATness:IF
 :CALibration:FLATness:IF?

Arguments None

Returns <NR1>

0 indicates a normal end. For details of the error codes, refer to page 3-17.

Measurement Modes All

Examples :CALibration:FLATness:IF
 runs the IF Flatness calibration.

:CALibration:IQ:CORRection:MAGNitude? (Query Only)

Returns the magnitude values of the IF flatness correction factor.

Syntax :CALibration:IQ:CORRection:MAGNitude?

Arguments None

Returns #<Num_digit><Num_byte><Mag(1)><Mag(2)>...<Mag(n)>

Where
<Num_digit> is the number of digits in <Num_byte>.
<Num_byte> is the number of bytes of data that follow.
<Mag(n)>::=<NR1> is the magnitude value of IF flatness correction factor in dB.
n: Always 1024

Measurement Modes All

Examples :CALibration:IQ:CORRection:MAGNitude?
 might return #41024xxxx... (1024-byte data) for the magnitude correction data.

:CALibration:IQ:CORRection:PHASe? (Query Only)

Returns the phase values of IF flatness correction factor.

Syntax :CALibration:IQ:CORRection:PHASe?

Arguments None

Returns #<Num_digit><Num_byte><Phase(1)><Phase(2)>...<Phase(n)>

Where

<Num_digit> is the number of digits in <Num_byte>.

<Num_byte> is the number of bytes of data that follow.

<Phase(n)> ::= <NR1> is the phase value of IF flatness correction factor in degrees. n: Always 1024

Measurement Modes All

Examples :CALibration:IQ:CORRection:PHASe?
might return #41024xxxx... (1024-byte data) for the phase correction data.

:CALibration:IQ:HEADer? (Query Only)

Returns the header of an IQ data file.

For details on the header, refer to *File Format* in the *RSA3408A User Manual*.

Use the :CALibration:IQ:VFrame[:TYPE] command to select the valid frame type of IQ data.

Syntax :CALibration:IQ:HEADer?

Arguments None

Returns <string> contains the header information.

Examples :CALibration:IQ:HEADer?
might return the following header information:

```
"<CR><LF>Type=RSA3408AIQT<CR><LF>FrameReverse=OFF<CR><LF>
FramePadding=Before<CR><LF>Band=RF3<CR><LF>
MemoryMode=Zoom<CR><LF>FFTPoints=1024<CR><LF>Bins=801<CR><LF>
MaxInputLevel=0<CR><LF>LevelOffset=0<CR><LF>
CenterFrequency=7.9G<CR><LF>Span=5M<CR><LF>BlockSize=40<CR><LF>
ValidFrames=40<CR><LF>FramePeriod=160u<CR><LF>
UnitPeriod=160u<CR><LF>FrameLength=160u<CR><LF>
DateTime=2005/01/01@ 12:00:00<CR><LF>
GainOffset=-82.3326910626668<CR><LF>MultiFrames=1<CR><LF>
MultiAddr=0<CR><LF>IOffset=-0.0475921630859375<CR><LF>
QOffset=0.12628173828125<CR><LF>"
```

Related Commands :CALibration:IQ:VFrame[:TYPE]

:CALibration:IQ:VFRame:BNUMber(?)

Specifies or queries the block number when :CALibration:IQ:VFRame[:TYPE] is set to BLOCk.

Syntax :CALibration:IQ:VFRame:BNUMber <value>
:CALibration:IQ:VFRame:BNUMber?

Arguments <value>::=<NR1> sets the block number. Range: -63999 to 0

Measurement Modes All

Examples :CALibration:IQ:VFRame:BNUMber -100
sets the block number to -100.

Related Commands :CALibration:IQ:VFRame[:TYPE]

:CALibration:IQ:VFRame[:TYPE](?)

Selects or queries the type of valid frame of IQ data to get the data file header information with the :CALibration:IQ:HEADer? query.

Syntax :CALibration:IQ:VFRame[:TYPE] { ALL | BLOCk }
:CALibration:IQ:VFRame[:TYPE]?

Arguments ALL selects all IQ data acquired on the memory.
BLOCk selects IQ data of the block specified with the :CALibration:IQ:VFRame:BNUMber command.

Measurement Modes All

Examples :CALibration:IQ:VFRame:TYPE ALL
selects all IQ data for getting the data file header information.

Related Commands :CALibration:IQ:HEADer?, :CALibration:IQ:VFRame:BNUMber

:CALibration:OFFSet:BASebanddc(?)

Runs the baseband DC offset calibration. The query version of this command runs the calibration and, if it ends normally, returns 0.

NOTE. This command is available when the analyzer operates in the baseband (DC to 40 MHz).

Syntax :CALibration:OFFSet:BASebanddc
:CALibration:OFFSet:BASebanddc?

Arguments None

Returns <NR1>
0 indicates a normal end. For details of the error codes, refer to page 3-17.

Measurement Modes All

Examples :CALibration:OFFSet:BASebanddc
runs the baseband DC offset calibration.

:CALibration:OFFSet:CENTer(?)

Runs the center offset calibration. The query version of this command runs the calibration and, if it ends normally, returns 0.

Syntax :CALibration:OFFSet:CENTer
:CALibration:OFFSet:CENTer?

Arguments None

Returns <NR1>

0 indicates a normal end. For details of the error codes, refer to page 3-17.

Measurement Modes All

Examples :CALibration:OFFSet:CENTer
runs the center offset calibration.

:CALibration:OFFSet:IQINput(?)

Option 03 Only

Runs the IQ input offset calibration. The query version of this command runs the calibration, and if it ends normally, returns 0.

NOTE. Before running the IQ input offset calibration, connect the I/Q signal to the I/Q input connector on the rear panel and set the I/Q signal level to 0.

To run this command, you must have selected IQ in the [:SENSe]:FEED command.

Syntax :CALibration:OFFSet:IQINput
:CALibration:OFFSet:IQINput?

Arguments None

Returns <NR1>
0 indicates a normal end. For details of the error codes, refer to page 3-17.

Measurement Modes All

Examples :CALibration:OFFSet:IQINput
runs the IQ input offset calibration.

Related Commands [:SENSe]:FEED

:CALibration:RF(?)

Runs the RF gain calibration. The query version of this command runs the calibration and, if it ends normally, returns 0.

Syntax :CALibration:RF
:CALibration:RF?

Arguments None

Returns <NR1>
0 indicates a normal end. For details of the error codes, refer to page 3-17.

Measurement Modes All

Examples :CALibration:RF
runs the RF gain calibration.

Related Commands :CALibration:AUTO

:CONFigure Commands

The :CONFigure commands set up the analyzer to the default settings for the specified measurement.

Command Tree

Header	Parameter
:CONFigure	
:ADEMod	
:AM	
:FM	
:PM	
:PSpectrum	
:CCDF	
:OView	
:PULSe	
:SPECTrum	
:ACPower	
:CFrequency	
:CHPower	
:CNRatio	
:EBWidth	
:OBWidth	
:SPURious	
:TFrequency	
:RTIME	
:SGRam	
:TRANSient	
:FVTime	
:IQVTime	
:PVTime	

NOTE. Data acquisition stops on completion of a :CONFigure command. Each command has a front-panel equivalent, except data acquisition control. The front-panel key sequence is provided with each command description.

:CONFigure:ADEMod:AM (No Query Form)

Sets the analyzer to the default settings for AM signal analysis.
Running this command is equivalent to pressing the following front-panel keys:

DEMOD key → **Analog Demod** side key → **PRESET** key
→ **AM Demod** side key

Syntax :CONFigure:ADEMod:AM

Arguments None

Measurement Modes DEMADEM

Examples :CONFigure:ADEMod:AM
sets the analyzer to the default settings for AM signal analysis.

Related Commands :INSTRument[:SElect]

:CONFigure:ADEMod:FM (No Query Form)

Sets the analyzer to the default settings for FM signal analysis.
Running this command is equivalent to pressing the following front-panel keys:

DEMOD key → **Analog Demod** side key → **PRESET** key
→ **FM Demod** side key

Syntax :CONFigure:ADEMod:FM

Arguments None

Measurement Modes DEMADEM

Examples :CONFigure:ADEMod:FM
sets the analyzer to the default settings for FM signal analysis.

Related Commands :INSTRument[:SElect]

:CONFigure:ADEMod:PM (No Query Form)

Sets the analyzer to the default settings for PM signal analysis.
Running this command is equivalent to pressing the following front-panel keys:

DEMODO key → **Analog Demod** side key → **PRESET** key
→ **PM Demod** side key

Syntax :CONFigure:ADEMod:PM

Arguments None

Measurement Modes DEMADEM

Examples :CONFigure:ADEMod:PM
sets the analyzer to the default settings for PM signal analysis.

Related Commands :INSTrument[:SElect]

:CONFigure:ADEMod:PSpectrum (No Query Form)

Sets the analyzer to the default settings for the pulse spectrum measurement.
Running this command is equivalent to pressing the following front-panel keys:

DEMODO key → **Analog Demod** side key → **PRESET** key
→ **Pulse Spectrum** side key

Syntax :CONFigure:ADEMod:PSpectrum

Arguments None

Measurement Modes DEMADEM

Examples :CONFigure:ADEMod:PSpectrum
sets the analyzer to the default settings for the pulse spectrum measurement.

Related Commands :INSTrument[:SElect]

:CONFigure:CCDF (No Query Form)

Sets the analyzer to the default settings for CCDF measurement.
Running this command is equivalent to pressing the following front-panel keys:
TIME key → **CCDF** side key → **PRESET** key → **CCDF** side key

Syntax	:CONFigure:CCDF
Arguments	None
Measurement Modes	TIMCCDF
Examples	:CONFigure:CCDF sets the analyzer to the default settings for CCDF measurement.
Related Commands	:INSTrument[:SElect]

:CONFigure:OVlew (No Query Form)

Turns the measurement off in the Demod (modulation analysis) and the Time (time analysis) modes to obtain data in the overview with the :FETCh:OVlew? or the :READ:OVlew? command. Running this command is equivalent to pressing the following front-panel keys:
MEASURE key → **Measurement Off** side key

Syntax	:CONFigure:OVlew
Arguments	None
Measurement Modes	All Demod modes, all Time modes
Examples	:CONFigure:OVlew turns the measurement off in the Demod and the Time modes.
Related Commands	:FETCh:OVlew?, :READ:OVlew?, :INSTrument[:SElect]

:CONFigure:PULSe (No Query Form)

Sets the analyzer to the default settings for the pulse measurements.
Running this command is equivalent to pressing the following front-panel keys:

TIME key → **Pulse Measurements** side key → **PRESET** key

Syntax	:CONFigure:PULSe
Arguments	None
Measurement Modes	TIMPULSE
Examples	:CONFigure:PULSe sets the analyzer to the default settings for pulse characteristics measurement.
Related Commands	:INSTrument[:SELEct]

:CONFigure:SPECtrum (No Query Form)

Sets the analyzer to the default settings for spectrum measurement.
Running this command is equivalent to pressing the following front-panel keys:

S/A key → { **Spectrum Analyzer** | **S/A with Spectrogram** | **Real Time S/A** | **Standard...** } → { **W-CDMA-UL** | **3GPP-R5-DL** } side key → **PRESET** key
→ **Measurement Off** side key

Syntax	:CONFigure:SPECtrum
Arguments	None
Measurement Modes	All S/A modes
Examples	:CONFigure:SPECtrum sets the analyzer to the default settings for spectrum measurement.
Related Commands	:INSTrument[:SELEct]

:CONFigure:SPECTrum:ACPower (No Query Form)

Sets the analyzer to the default settings for adjacent channel leakage power ratio (ACPR) measurement. Running this command is equivalent to pressing the following front-panel keys:

S/A key → { **Spectrum Analyzer** | **S/A with Spectrogram** | **Real Time S/A** | **Standard...** → **W-CDMA-UL** } side key → **PRESET** key
→ **ACPR** or **ACLR** side key

Syntax :CONFigure:SPECTrum:ACPower

Arguments None

Measurement Modes SANORMAL, SASGRAM, SARTIME, SAUL3G

Examples :CONFigure:SPECTrum:ACPower
sets the analyzer to the default settings for ACPR measurement.

Related Commands :INSTrument[:SElect]

:CONFigure:SPECTrum:CFrequency (No Query Form)

Sets the analyzer to the default settings for carrier frequency measurement. Running this command is equivalent to pressing the following front-panel keys:

S/A key → { **Spectrum Analyzer** | **S/A with Spectrogram** | **Real Time S/A** | **Standard...** → { **W-CDMA-UL** | **3GPP-R5-DL** } } side key → **PRESET** key
→ **Carrier Frequency** side key

Syntax :CONFigure:SPECTrum:CFrequency

Arguments None

Measurement Modes All S/A modes

Examples :CONFigure:SPECTrum:CFrequency
sets the analyzer to the default settings for carrier frequency measurement.

Related Commands :INSTrument[:SElect]

:CONFigure:SPECTrum:CHPower (No Query Form)

Sets the analyzer to the default settings for channel power measurement. Running this command is equivalent to pressing the following front-panel keys:

S/A key → { **Spectrum Analyzer** | **S/A with Spectrogram** | **Real Time S/A** | **Standard...** → **W-CDMA-UL** } side key → **PRESET** key
→ **Channel Power** side key

Syntax	:CONFigure:SPECTrum:CHPower
Arguments	None
Measurement Modes	SANORMAL, SASGRAM, SARTIME, SAUL3G
Examples	:CONFigure:SPECTrum:CHPower sets the analyzer to the default settings for channel power measurement.
Related Commands	:INSTrument[:SElect]

:CONFigure:SPECTrum:CNRatio (No Query Form)

Sets the analyzer to the default settings for carrier-to-noise ratio (C/N) measurement. Running this command is equivalent to pressing the following front-panel keys:

S/A key → { **Spectrum Analyzer** | **S/A with Spectrogram** | **Real Time S/A** | **Standard...** → **W-CDMA-UL** } side key → **PRESET** key → **C/N** side key

Syntax	:CONFigure:SPECTrum:CNRatio
Arguments	None
Measurement Modes	SANORMAL, SASGRAM, SARTIME, SAUL3G
Examples	:CONFigure:SPECTrum:CNRatio sets the analyzer to the default settings for C/N measurement.
Related Commands	:INSTrument[:SElect]

:CONFigure:SPECTrum:EBWidth (No Query Form)

Sets the analyzer to the default settings for emission bandwidth (EBW) measurement. Running this command is equivalent to pressing the following front-panel keys:

S/A key → { **Spectrum Analyzer** | **S/A with Spectrogram** | **Real Time S/A** | **Standard...** } → { **W-CDMA-UL** | **3GPP-R5-DL** } side key → **PRESET** key → **EBW** side key

Syntax :CONFigure:SPECTrum:EBWidth

Arguments None

Measurement Modes All S/A modes

Examples :CONFigure:SPECTrum:EBWidth
sets the analyzer to the default settings for EBW measurement.

Related Commands :INSTRument[:SElect]

:CONFigure:SPECTrum:OBWidth (No Query Form)

Sets the analyzer to the default settings for occupied bandwidth (OBW) measurement. Running this command is equivalent to pressing the following front-panel keys:

S/A key → { **Spectrum Analyzer** | **S/A with Spectrogram** | **Real Time S/A** | **Standard...** } → **W-CDMA-UL** } side key → **PRESET** key → **OBW** side key

Syntax :CONFigure:SPECTrum:OBWidth

Arguments None

Measurement Modes SANORMAL, SASGRAM, SARTIME, SAUL3G

Examples :CONFigure:SPECTrum:OBWidth
sets the analyzer to the default settings for OBW measurement:

Related Commands :INSTRument[:SElect]

:CONFigure:SPECTrum:SPURious (No Query Form)

The following example sets the analyzer to the default settings for spurious emission measurement. Running this command is equivalent to pressing the following front-panel keys:

S/A key → { **Spectrum Analyzer** | **S/A with Spectrogram** | **Real Time S/A** }
side key → **PRESET** key → **Spurious** side key

Syntax	:CONFigure:SPECTrum:SPURious
Arguments	None
Measurement Modes	SANORMAL, SASGRAM, SARTIME
Examples	:CONFigure:SPECTrum:SPURious sets the analyzer to the default settings for spurious signal measurement.
Related Commands	:INSTrument[:SElect]

:CONFigure:TFRequency:RTIME (No Query Form)

Sets the analyzer to the default settings for the real-time spectrum measurement. Running this command is equivalent to pressing the following front-panel keys:

S/A key → **Real Time S/A** side key → **PRESET** key

Syntax	:CONFigure:TFRequency:RTIME
Arguments	None
Measurement Modes	SARTIME
Examples	:CONFigure:TFRequency:RTIME sets the analyzer to the default settings for the real-time spectrum measurement.
Related Commands	:INSTrument[:SElect]

:CONFigure:TFRequency:SGRam (No Query Form)

Sets the analyzer to the default settings for the spectrogram measurement.
Running this command is equivalent to pressing the following front-panel keys:

S/A key → **S/A with Spectrogram** side key → **PRESET** key

Syntax :CONFigure:TFRequency:SGRam

Arguments None

Measurement Modes SASGRAM

Examples :CONFigure:TFRequency:SGRam
sets the analyzer to the default settings for the spectrogram measurement.

Related Commands :INSTRument[:SElect]

:CONFigure:TRANSient:FVTime (No Query Form)

Sets the analyzer to the default settings for frequency vs. time measurement.
Running this command is equivalent to pressing the following front-panel keys:

TIME key → **Transient** side key → **PRESET** key
→ **Frequency versus Time** side key

Syntax :CONFigure:TRANSient:FVTime

Arguments None

Measurement Modes TIMTRAN

Examples :CONFigure:TRANSient:FVTime
sets the analyzer to the default settings for frequency vs. time measurement.

Related Commands :INSTRument[:SElect]

:CONFigure:TRANsient:IQVTime (No Query Form)

Sets the analyzer to the default settings for IQ level vs. time measurement.

Running this command is equivalent to pressing the following front-panel keys:

TIME key → **Transient** side key → **PRESET** key → **IQ versus Time** side key

Syntax :CONFigure:TRANsient:IQVTime

Arguments None

Measurement Modes TIMTRAN

Examples :CONFigure:TRANsient:IQVTime
sets the analyzer to the default settings for IQ level vs. time measurement.

Related Commands :INSTrument[:SElect]

:CONFigure:TRANsient:PVTime (No Query Form)

Sets the analyzer to the default settings for power vs. time measurement.

Running this command is equivalent to pressing the following front-panel keys:

S/A key → **Transient** side key → **PRESET** key
→ **Power versus Time** side key

Syntax :CONFigure:TRANsient:PVTime

Arguments None

Measurement Modes TIMTRAN

Examples :CONFigure:TRANsient:PVTime
sets the analyzer to the default settings for power vs. time measurement.

Related Commands :INSTrument[:SElect]

:CONFigure Commands (Option)

This section describes the :CONFigure commands for optional analysis software as shown in Table 2-36.

Table 2-36: :CONFigure command subgroups (Option)

Command header	Function	Refer to:
Option 21 Advanced measurement suite related		
:CONFigure:DDEMod	Sets up the analyzer for the digital modulation measurements.	page 2-132
:CONFigure:RFID	Sets up the analyzer for the RFID measurements.	page 2-133
:CONFigure:SSource	Sets up the analyzer for the signal source measurements.	page 2-134
Option 23 W-CDMA uplink analysis related		
:CONFigure:AC3Gpp	Sets up the analyzer for the W-CDMA ACLR measurement.	page 2-135
:CONFigure:UL3Gpp	Sets up the analyzer for the W-CDMA uplink measurements.	page 2-136
Option 24 GSM/EDGE analysis related		
:CONFigure:GSMedge	Sets up the analyzer for the GSM/EDGE measurements.	page 2-137
Option 25 cdma2000 analysis related		
:CONFigure:FLCDMA2K RLCDMA2K	Sets up the analyzer for the cdma2000 measurements.	page 2-141
Option 26 1xEV-DO analysis related		
:CONFigure:FL1XEVD0 RL1XEVD0	Sets up the analyzer for the 1xEV-DO measurements.	page 2-151
Option 27 3GPP-R5 analysis		
:CONFigure:DLR5_3GPP	Sets up the analyzer for the 3GPP-R5 downlink measurements.	page 2-161
:CONFigure:SADLR5_3GPP SAULR5_3GPP	Sets up the analyzer for the 3GPP-R5 spectrum analysis.	page 2-162
:CONFigure:ULR5_3GPP	Sets up the analyzer for the 3GPP-R5 uplink measurements.	page 2-167
Option 28 TD-SCDMA analysis related		
:CONFigure:TD_SCDMA	Sets up the analyzer for the TD-SCDMA measurements.	page 2-168
Option 29 WLAN analysis related		
:CONFigure:M2WLAN	Sets up the analyzer for the 802.11n MIMO 2x2 measurements.	page 2-175
:CONFigure:SWLAN	Sets up the analyzer for the 802.11n (nx1) measurements.	page 2-176
:CONFigure:WLAN	Sets up the analyzer for the 802.11a/b/g measurements.	page 2-178
Option 40 3GPP-R6 analysis		
:CONFigure:DLR6_3GPP	Sets up the analyzer for the 3GPP-R6 downlink measurements.	page 2-180
:CONFigure:ULR6_3GPP	Sets up the analyzer for the 3GPP-R6 uplink measurements.	page 2-181

:CONFigure:DDEMod Subgroup

Modulation Analysis, Option 21 Only

The :CONFigure:DDEMod commands set up the conditions related to the digital modulation analysis.

Command Tree	Header	Parameter
	:CONFigure :DDEMod	

:CONFigure:DDEMod (No Query Form)

Sets the analyzer to the default settings for digital modulation analysis. Running this command is equivalent to pressing the following front-panel keys:

DEMODO key → **Digital Demod** side key → **PRESET** key
→ **IQ/Frequency versus Time** side key

Syntax	:CONFigure:DDEMod
Arguments	None
Measurement Modes	DEMDDEM
Examples	:CONFigure:DDEMod sets the analyzer to the default settings for digital modulation analysis.
Related Commands	:INSTrument[:SElect]

:CONFigure:RFID Subgroup*RFID Analysis, Option 21 Only*

The :CONFigure:RFID commands set up the conditions related to the RFID (Radio Frequency Identification) analysis.

Command Tree	Header	Parameter
	:CONFigure	
	:RFID	

:CONFigure:RFID (No Query Form)

Sets the analyzer to the default settings for the RFID measurement. Running this command is equivalent to pressing the following front-panel keys:

DEM key → **Standard...** side key → **RFID** side key → **PRESET** key

Syntax :CONFigure:RFID

Arguments None

Measurement Modes DEMRFID

Examples :CONFigure:RFID
sets the analyzer to the default settings for the RFID measurement.

Related Commands :INSTrument[:SElect]

:CONFigure:SSource Subgroup

Signal Source Analysis, Option 21 Only

The :CONFigure:SSource commands set up the conditions related to the signal source analysis.

Command Tree	Header	Parameter
	:CONFigure	
	:SSource	

:CONFigure:SSource (No Query Form)

Sets the analyzer to the default settings for the signal source analysis. Running this command is equivalent to pressing the following front-panel keys:

TIME key → **Signal Source Analysis** side key → **PRESET** key

Syntax :CONFigure:SSource

Arguments None

Measurement Modes TIMSSOURCE

Examples :CONFigure:SSource
sets the analyzer to the default settings for the signal source analysis.

Related Commands :INSTrument[:SElect]

:CONFigure:AC3Gpp Subgroup*W-CDMA, Option 23 Only*

The :CONFigure:AC3Gpp commands set up the conditions related to the ACLR measurement under the W-CDMA standard.

Command Tree	Header	Parameter
	:CONFigure	
	:AC3Gpp	

:CONFigure:AC3Gpp (No Query Form)

Sets the analyzer to the default settings for the W-CDMA ACLR (Adjacent Channel Leakage Power Ratio) measurement. Running this command is equivalent to pressing the following front-panel keys:

DEMODO key → **Standard...** side key → **W-CDMA-UL** side key
→ **PRESET** key → **ACLR** side key

Syntax	:CONFigure:AC3Gpp
Arguments	None
Measurement Modes	SADL3G, SAUL3G
Examples	:CONFigure:AC3Gpp sets the analyzer to the default settings for W-CDMA ACLR measurement.
Related Commands	:INSTrument[:SElect]

:CONFigure:UL3Gpp Subgroup

W-CDMA, Option 23 Only

The :CONFigure:DL3Gpp commands set up the conditions related to the W-CDMA uplink analysis.

Command Tree	Header	Parameter
	:CONFigure :UL3Gpp	

:CONFigure:UL3Gpp (No Query Form)

Sets the analyzer to the default settings for W-CDMA uplink analysis. Running this command is equivalent to pressing the following front-panel keys:

DEMOD key → **Standard...** side key → **W-CDMA-UL** side key
→ **PRESET** key

Syntax	:CONFigure:UL3Gpp
Arguments	None
Measurement Modes	DEMUL3G
Examples	:CONFigure:UL3Gpp sets the analyzer to the default settings for W-CDMA uplink analysis.
Related Commands	:INSTrument[:SElect]

:CONFigure:GSMedge Subgroup

GSM/EDGE, Option 24 Only

The :CONFigure:GSMedge commands set up the conditions related to the GSM/EDGE analysis.

Command Tree	Header	Parameter
	:CONFigure	
	:GSMedge	
	:MACCuracy	
	:MCPower	
	:MODulation	
	:PVTime	
	:SPURious	
	:SWITching	

:CONFigure:GSMedge:MACCuracy (No Query Form)

Sets the analyzer to the default settings for the modulation accuracy measurement under the GSM/EDGE standard. Running this command is equivalent to pressing the following front-panel keys:

DEMOD key → **Standard...** side key → **GSM/EDGE** side key
→ **PRESET** key → **Modulation Accuracy** side key

Syntax :CONFigure:GSMedge:MACCuracy

Arguments None

Measurement Modes DEMGSMEDGE

Examples :CONFigure:GSMedge:MACCuracy
sets the analyzer to the default settings for the modulation accuracy measurement.

Related Commands :INSTrument[:SElect]

:CONFigure:GSMedge:MCPower (No Query Form)

Sets the analyzer to the default settings for the mean carrier power measurement under the GSM/EDGE standard. Running this command is equivalent to pressing the following front-panel keys:

DEMOD key → **Standard...** side key → **GSM/EDGE** side key
→ **PRESET** key → **Mean Carrier Power** side key

Syntax :CONFigure:GSMedge:MCPower

Arguments None

Measurement Modes DEMGSMEDGE

Examples :CONFigure:GSMedge:MCPower
sets the analyzer to the default settings for the mean carrier power measurement.

Related Commands :INSTrument[:SElect]

:CONFigure:GSMedge:MODulation (No Query Form)

Sets the analyzer to the default settings for the modulation spectrum measurement under the GSM/EDGE standard. Running this command is equivalent to pressing the following front-panel keys:

DEMODO key → **Standard...** side key → **GSM/EDGE** side key
→ **PRESET** key → **Modulation Spectrum** side key

Syntax	:CONFigure:GSMedge:MODulation
Arguments	None
Measurement Modes	DEMGSMEDGE
Examples	:CONFigure:GSMedge:MODulation sets the analyzer to the default settings for the modulation spectrum measurement.
Related Commands	:INSTrument[:SElect]

:CONFigure:GSMedge:PVTime (No Query Form)

Sets the analyzer to the default settings for the power versus time measurement under the GSM/EDGE standard. Running this command is equivalent to pressing the following front-panel keys:

DEMODO key → **Standard...** side key → **GSM/EDGE** side key
→ **PRESET** key → **Power versus Time** side key

Syntax	:CONFigure:GSMedge:PVTime
Arguments	None
Measurement Modes	DEMGSMEDGE
Examples	:CONFigure:GSMedge:PVTime sets the analyzer to the default settings for the power versus time measurement.
Related Commands	:INSTrument[:SElect]

:CONFigure:GSMedge:SPURious (No Query Form)

Sets the analyzer to the default settings for the spurious measurement under the GSM/EDGE standard. Running this command is equivalent to pressing the following front-panel keys:

DEMOD key → **Standard...** side key → **GSM/EDGE** side key
→ **PRESET** key → **Inband Spurious** side key

Syntax :CONFigure:GSMedge:SPURious

Arguments None

Measurement Modes DEMGSMEDGE

Examples :CONFigure:GSMedge:SPURious
sets the analyzer to the default settings for the spurious measurement.

Related Commands :INSTRument[:SElect]

:CONFigure:GSMedge:SWITching (No Query Form)

Sets the analyzer to the default settings for the switching spectrum measurement under the GSM/EDGE standard. Running this command is equivalent to pressing the following front-panel keys:

DEMOD key → **Standard...** side key → **GSM/EDGE** side key
→ **PRESET** key → **Switching Spectrum** side key

Syntax :CONFigure:GSMedge:SWITching

Arguments None

Measurement Modes DEMGSMEDGE

Examples :CONFigure:GSMedge:SWITching
sets the analyzer to the default settings for the switching spectrum measurement under the GSM/EDGE standard.

Related Commands :INSTRument[:SElect]

:CONFigure:FLCDMA2K|:RLCDMA2K Subgroup

cdma2000, Option 25 Only

The :CONFigure:FLCDMA2K|:RLCDMA2K commands set up the conditions related to the cdma2000 forward and reverse link analysis.

Command Tree	Header	Parameter
	:CONFigure	
	:FLCDMA2K :RLCDMA2K	
	:ACPower	
	:CCDF	
	:CDPower	
	:CHPower	
	:IM	
	:MACCuracy	
	:OBWidth	
	:PCCHannel	
	:PVTime	
	:SEMask	

:CONFigure:FLCDMA2K|:RLCDMA2K:ACPower (No Query Form)

Sets the analyzer to the default settings for the ACPR measurement under the cdma2000 forward or reverse link standard. Running this command is equivalent to pressing the following front-panel keys:

DEMOD key → **Standard...** side key → { **cdma2000-Fwd** | **cdma2000-Rev** }
side key → **PRESET** key → **ACPR** side key

Syntax :CONFigure:FLCDMA2K|:RLCDMA2K:ACPower

Arguments None

Measurement Modes DEMFLCDMA2K, DEMRLCDMA2K

Examples :CONFigure:FLCDMA2K:ACPower
sets the analyzer to the default settings for the ACPR measurement under the cdma2000 forward link standard.

Related Commands :INSTrument[:SElect]

:CONFigure:FLCDMA2K[:RLCDMA2K]:CCDF (No Query Form)

Sets the analyzer to the default settings for the CCDF measurement under the cdma2000 forward or reverse link standard. Running this command is equivalent to pressing the following front-panel keys:

DEMOD key → Standard... side key → { cdma2000-Fwd | cdma2000-Rev }
side key → PRESET key → CCDF side key

Syntax :CONFigure:FLCDMA2K[:RLCDMA2K]:CCDF

Arguments None

Measurement Modes DEMFLCDMA2K, DEMRLCDMA2K

Examples :CONFigure:FLCDMA2K:CCDF
sets the analyzer to the default settings for the CCDF measurement under the cdma2000 forward link standard.

Related Commands :INSTrument[:SElect]

:CONFigure:FLCDMA2K|:RLCDMA2K:CDPower (No Query Form)

Sets the analyzer to the default settings for the code domain power measurement under the cdma2000 forward or reverse link standard. Running this command is equivalent to pressing the following front-panel keys:

DEMMOD key → **Standard...** side key → { **cdma2000-Fwd** | **cdma2000-Rev** }
side key → **PRESET** key → **Code Domain Power** side key

Syntax :CONFigure:FLCDMA2K|:RLCDMA2K:CDPower

Arguments None

Measurement Modes DEMFLCDMA2K, DEMRLCDMA2K

Examples :CONFigure:FLCDMA2K:CDPower
sets the analyzer to the default settings for the code domain power measurement under the cdma2000 forward link standard.

Related Commands :INSTRument[:SElect]

:CONFigure:FLCDMA2K|:RLCDMA2K:CHPower (No Query Form)

Sets the analyzer to the default settings for the channel power measurement under the cdma2000 forward or reverse link standard. Running this command is equivalent to pressing the following front-panel keys:

DEMOD key → Standard... side key → { cdma2000-Fwd | cdma2000-Rev } side key → PRESET key → Channel Power side key

Syntax :CONFigure:FLCDMA2K|:RLCDMA2K:CHPower

Arguments None

Measurement Modes DEMFLCDMA2K, DEMRLCDMA2K

Examples :CONFigure:FLCDMA2K:CHPower
sets the analyzer to the default settings for the channel power measurement under the cdma2000 forward link standard.

Related Commands :INSTrument[:SElect]

:CONFigure:FLCDMA2K|:RLCDMA2K:IM (No Query Form)

Sets the analyzer to the default settings for the intermodulation measurement under the cdma2000 forward or reverse link standard. Running this command is equivalent to pressing the following front-panel keys:

DEMOD key → **Standard...** side key → { **cdma2000-Fwd** | **cdma2000-Rev** } side key → **PRESET** key → **Intermodulation** side key

Syntax :CONFigure:FLCDMA2K|:RLCDMA2K:IM

Arguments None

Measurement Modes DEMFLCDMA2K, DEMRLCDMA2K

Examples :CONFigure:FLCDMA2K:IM
sets the analyzer to the default settings for the intermodulation measurement under the cdma2000 forward link standard.

Related Commands :INSTRument[:SElect]

:CONFigure:FLCDMA2K[:RLCDMA2K]:MACCuracy (No Query Form)

Sets the analyzer to the default settings for the modulation accuracy measurement under the cdma2000 forward or reverse link standard. Running this command is equivalent to pressing the following front-panel keys:

DEMOM key → **Standard...** side key → { **cdma2000-Fwd** | **cdma2000-Rev** } side key → **PRESET** key → **Modulation Accuracy** side key

Syntax :CONFigure:FLCDMA2K[:RLCDMA2K]:MACCuracy

Arguments None

Measurement Modes DEMFLCDMA2K, DEMRLCDMA2K

Examples :CONFigure:FLCDMA2K:MACCuracy
sets the analyzer to the default settings for the modulation accuracy measurement under the cdma2000 forward link standard.

Related Commands :INSTrument[:SElect]

:CONFigure:FLCDMA2K|:RLCDMA2K:OBWidth (No Query Form)

Sets the analyzer to the default settings for the OBW (Occupied Bandwidth) measurement under the cdma2000 forward or reverse link standard. Running this command is equivalent to pressing the following front-panel keys:

DEMOD key → **Standard...** side key → { **cdma2000-Fwd** | **cdma2000-Rev** }
side key → **PRESET** key → **OBW** side key

Syntax :CONFigure:FLCDMA2K|:RLCDMA2K:OBWidth

Arguments None

Measurement Modes DEMFLCDMA2K, DEMRLCDMA2K

Examples :CONFigure:FLCDMA2K:OBWidth
sets the analyzer to the default settings for the OBW measurement under the cdma2000 forward link standard.

Related Commands :INSTrument[:SElect]

:CONFigure:FLCDMA2K[:RLCDMA2K:PCCHannel (No Query Form)

Sets the analyzer to the default settings for the pilot to code channel measurement under the cdma2000 forward or reverse link standard. Running this command is equivalent to pressing the following front-panel keys:

DEMOM key → **Standard...** side key → { **cdma2000-Fwd** | **cdma2000-Rev** }
side key → **PRESET** key → **Pilot to Code Channel** side key

Syntax :CONFigure:FLCDMA2K[:RLCDMA2K:PCCHannel

Arguments None

Measurement Modes DEMFLCDMA2K, DEMRLCDMA2K

Examples :CONFigure:FLCDMA2K:PCCHannel
sets the analyzer to the default settings for the pilot to code channel measurement under the cdma2000 forward link standard.

Related Commands :INSTrument[:SElect]

:CONFigure:RLCDMA2K:PVTime (No Query Form)

Sets the analyzer to the default settings for the gated output power measurement under the cdma2000 reverse link standard. Running this command is equivalent to pressing the following front-panel keys:

DEMOD key → **Standard...** side key → **cdma2000-Rev** side key
→ **PRESET** key → **Gated Output Power** side key

Syntax :CONFigure:RLCDMA2K:PVTime

Arguments None

Measurement Modes DEMRLCDMA2K

Examples :CONFigure:RLCDMA2K:PVTime
sets the analyzer to the default settings for the gated output power measurement.

Related Commands :INSTRument[:SElect]

:CONFigure:FLCDMA2K|:RLCDMA2K:SEMask (No Query Form)

Sets the analyzer to the default settings for the spectrum emission mask measurement under the cdma2000 forward or reverse link standard. Running this command is equivalent to pressing the following front-panel keys:

DEMOD key → **Standard...** side key → { **cdma2000-Fwd** | **cdma2000-Rev** }
side key → **PRESET** key → **Pilot to Code Channel** side key

Syntax :CONFigure:FLCDMA2K|:RLCDMA2K:SEMask

Arguments None

Measurement Modes DEMFLCDMA2K, DEMRLCDMA2K

Examples :CONFigure:FLCDMA2K:SEMask
sets the analyzer to the default settings for the spectrum emission mask measurement under the cdma2000 forward link standard.

Related Commands :INSTRument[:SElect]

:CONFigure:FL1XEVD0|:RL1XEVD0 Subgroup**1xEV-DO, Option 26 Only**

The :CONFigure:FL1XEVD0|:RL1XEVD0 commands set up the conditions related to the cdma2000 forward and reverse link analysis.

Command Tree	Header	Parameter
	:CONFigure	
	:FL1XEVD0 :RL1XEVD0	
	:ACPower	
	:CCDF	
	:CDPower	
	:CHPower	
	:IM	
	:MACCuracy	
	:OBWidth	
	:PCCHannel	
	:PVTime	
	:SEMask	

:CONFigure:FL1XEVD0|:RL1XEVD0:ACPower (No Query Form)

Sets the analyzer to the default settings for the ACPR measurement under the 1xEVDO forward or reverse link standard. Running this command is equivalent to pressing the following front-panel keys:

DEMOD key → **Standard...** side key → { **1xEV-DO-Fwd** | **1xEV-DO-Rev** }
side key → **PRESET** key → **ACPR** side key

Syntax :CONFigure:FL1XEVD0|:RL1XEVD0:ACPower

Arguments None

Measurement Modes DEMFL1XEVD0, DEMRL1XEVD0

Examples :CONFigure:FL1XEVD0:ACPower
sets the analyzer to the default settings for the ACPR measurement under the 1xEV-DO forward link standard.

Related Commands :INSTrument[:SElect]

:CONFigure:FL1XEVD0|:RL1XEVD0:CCDF (No Query Form)

Sets the analyzer to the default settings for the CCDF measurement under the 1xEV-DO forward or reverse link standard. Running this command is equivalent to pressing the following front-panel keys:

DEMOD key → Standard... side key → { 1xEV-DO-Fwd | 1xEV-DO-Rev }
side key → PRESET key → CCDF side key

Syntax :CONFigure:FL1XEVD0|:RL1XEVD0:CCDF

Arguments None

Measurement Modes DEMFL1XEVD0, DEMRL1XEVD0

Examples :CONFigure:FL1XEVD0:CCDF
sets the analyzer to the default settings for the CCDF measurement under the 1xEV-DO forward link standard.

Related Commands :INSTrument[:SElect]

:CONFigure:FL1XEVD0|RL1XEVD0:CDPower (No Query Form)

Sets the analyzer to the default settings for the code domain power measurement under the 1xEV-DO forward or reverse link standard. Running this command is equivalent to pressing the following front-panel keys:

DEMMOD key → **Standard...** side key → { **1xEV-DO-Fwd** | **1xEV-DO-Rev** }
side key → **PRESET** key → **Code Domain Power** side key

Syntax :CONFigure:FL1XEVD0|RL1XEVD0:CDPower

Arguments None

Measurement Modes DEMFL1XEVD0, DEMRL1XEVD0

Examples :CONFigure:FL1XEVD0:CDPower
sets the analyzer to the default settings for the code domain power measurement under the 1xEV-DO forward link standard.

Related Commands :INSTRument[:SElect]

:CONFigure:FL1XEVD0|:RL1XEVD0:CHPower (No Query Form)

Sets the analyzer to the default settings for the channel power measurement under the 1xEV-DO forward or reverse link standard. Running this command is equivalent to pressing the following front-panel keys:

DEMOD key → Standard... side key → { 1xEV-DO-Fwd | 1xEV-DO-Rev }
side key → PRESET key → Channel Power side key

Syntax :CONFigure:FL1XEVD0|:RL1XEVD0:CHPower

Arguments None

Measurement Modes DEMFL1XEVD0, DEMRL1XEVD0

Examples :CONFigure:FL1XEVD0:CHPower
sets the analyzer to the default settings for the channel power measurement under the 1xEV-DO forward link standard.

Related Commands :INSTrument[:SElect]

:CONFigure:FL1XEVD0|:RL1XEVD0:IM (No Query Form)

Sets the analyzer to the default settings for the intermodulation measurement under the 1xEV-DO forward or reverse link standard. Running this command is equivalent to pressing the following front-panel keys:

DEMMOD key → **Standard...** side key → { **1xEV-DO-Fwd** | **1xEV-DO-Rev** }
side key → **PRESET** key → **Intermodulation** side key

Syntax :CONFigure:FL1XEVD0|:RL1XEVD0:IM

Arguments None

Measurement Modes DEMFL1XEVD0, DEMRL1XEVD0

Examples :CONFigure:FL1XEVD0:IM
sets the analyzer to the default settings for the intermodulation measurement under the 1xEV-DO forward link standard.

Related Commands :INSTRument[:SElect]

:CONFigure:FL1XEVD0|:RL1XEVD0:MACCuracy (No Query Form)

Sets the analyzer to the default settings for the modulation accuracy measurement under the 1xEV-DO forward or reverse link standard. Running this command is equivalent to pressing the following front-panel keys:

DEMOD key → **Standard...** side key → { **1xEV-DO-Fwd** | **1xEV-DO-Rev** }
side key → **PRESET** key → **Modulation Accuracy** side key

Syntax :CONFigure:FL1XEVD0|:RL1XEVD0:MACCuracy

Arguments None

Measurement Modes DEMFL1XEVD0, DEMRL1XEVD0

Examples :CONFigure:FL1XEVD0:MACCuracy
sets the analyzer to the default settings for the modulation accuracy measurement under the 1xEV-DO forward link standard.

Related Commands :INSTrument[:SElect]

:CONFigure:FL1XEVD0|:RL1XEVD0:OBWidth (No Query Form)

Sets the analyzer to the default settings for the OBW (Occupied Bandwidth) measurement under the 1xEV-DO forward or reverse link standard. Running this command is equivalent to pressing the following front-panel keys:

DEMOD key → **Standard...** side key → { **1xEV-DO-Fwd** | **1xEV-DO-Rev** }
side key → **PRESET** key → **OBW** side key

Syntax :CONFigure:FL1XEVD0|:RL1XEVD0:OBWidth

Arguments None

Measurement Modes DEMFL1XEVD0, DEMRL1XEVD0

Examples :CONFigure:FL1XEVD0:OBWidth
sets the analyzer to the default settings for the OBW measurement under the 1xEV-DO forward link standard.

Related Commands :INSTRument[:SElect]

:CONFigure:FL1XEVD0|:RL1XEVD0:PCCHannel (No Query Form)

Sets the analyzer to the default settings for the pilot to code channel measurement under the 1xEV-DO forward or reverse link standard. Running this command is equivalent to pressing the following front-panel keys:

DEMOD key → **Standard...** side key → { **1xEV-DO-Fwd** | **1xEV-DO-Rev** }
side key → **PRESET** key → **Pilot to Code Channel** side key

Syntax :CONFigure:FL1XEVD0|:RL1XEVD0:PCCHannel

Arguments None

Measurement Modes DEMFL1XEVD0, DEMRL1XEVD0

Examples :CONFigure:FL1XEVD0:PCCHannel
sets the analyzer to the default settings for the pilot to code channel measurement under the 1xEV-DO forward link standard.

Related Commands :INSTrument[:SElect]

:CONFigure:FL1XEVD0:PVTime (No Query Form)

Sets the analyzer to the default settings for the gated output power measurement under the 1xEV-DO forward link standard. Running this command is equivalent to pressing the following front-panel keys:

DEM0D key → **Standard...** side key → **1xEV-DO-Fwd** side key
→ **PRESET** key → **Gated Output Power** side key

Syntax	:CONFigure:FL1XEVD0:PVTime
Arguments	None
Measurement Modes	DEMFL1XEVD0
Examples	:CONFigure:FL1XEVD0:PVTime sets the analyzer to the default settings for the gated output power measurement.
Related Commands	:INSTRument[:SELEct]

:CONFigure:FL1XEVD0|:RL1XEVD0:SEMAsk (No Query Form)

Sets the analyzer to the default settings for the spectrum emission mask measurement under the 1xEV-DO forward or reverse link standard. Running this command is equivalent to pressing the following front-panel keys:

DEM0D key → **Standard...** side key → **1xEV-DO-Fwd** side key
→ **PRESET** key → **Spectrum Emission Mask** side key

Syntax	:CONFigure:FL1XEVD0 :RL1XEVD0:SEMAsk
Arguments	None
Measurement Modes	DEMFL1XEVD0, DEMRL1XEVD0
Examples	:CONFigure:FL1XEVD0:SEMAsk sets the analyzer to the default settings for the spectrum emission mask measurement under the 1xEV-DO forward link standard.
Related Commands	:INSTRument[:SELEct]

:CONFigure:DLR5_3GPP Subgroup**3GPP-R5, Option 27 Only**

The :CONFigure:DLR5_3GPP commands set up the conditions related to the 3GPP-R5 downlink modulation analysis.

Command Tree	Header	Parameter
	:CONFigure	
	:DLR5_3GPP	

:CONFigure:DLR5_3GPP (No Query Form)

Sets the analyzer to the default settings for the 3GPP-R5 downlink modulation measurements. This command is equivalent to the following key sequence:

DEMOD key → **Standard...** side key → **3GPP-R5-DL** side key
→ **PRESET** key

Syntax	:CONFigure:DLR5_3GPP
Arguments	None
Measurement Modes	DEMDLR5_3G
Examples	:CONFigure:DLR5_3GPP sets the analyzer to the default settings for the 3GPP-R5 downlink modulation measurements.
Related Commands	:INSTrument[:SElect]

:CONFigure:SADLR5_3GPP|:SAULR5_3GPP Subgroup

3GPP-R5, Option 27 Only

The :CONFigure:SADLR5_3GPP|:SAULR5_3GPP commands set up the conditions related to the 3GPP-R5 spectrum analysis.

Command Tree	Header	Parameter
	:CONFigure	
	:SADLR5_3GPP :SAULR5_3GPP	
	:ACLR	
	:CFrequency	
	:CHPower	
	:EBWidth	
	:MCAClr	
	:OBWidth	
	:SEMask	

:CONFigure:SADLR5_3GPP|:SAULR5_3GPP:ACLR (No Query Form)

Sets the analyzer to the default settings of the ACLR (Adjacent Channel Leakage Power Ratio) measurement for 3GPP-R5. This command is equivalent to the following key sequence:

S/A key → **Standard...** side key → { **3GPP-R5-DL** | **3GPP-R5-UL** } side key
→ **PRESET** key → **ACLR** side key

Syntax :CONFigure:SADLR5_3GPP|:SAULR5_3GPP:ACLR

Arguments None

Measurement Modes SADLR5_3G, SAULR5_3G

Examples :CONFigure:SADLR5_3GPP:ACLR
sets the analyzer to the default settings of the downlink ACLR measurement.

Related Commands :INSTrument[:SElect]

:CONFigure:SADLR5_3GPP|:SAULR5_3GPP:CFrequency (No Query Form)

Sets the analyzer to the default settings of the carrier frequency measurement for 3GPP-R5. This command is equivalent to the following key sequence:

S/A key → **Standard...** side key → { **3GPP-R5-DL** | **3GPP-R5-UL** } side key
→ **PRESET** key → **Carrier Frequency** side key

Syntax :CONFigure:SADLR5_3GPP|:SAULR5_3GPP:CFrequency

Arguments None

Measurement Modes SADLR5_3G, SAULR5_3G

Examples :CONFigure:SADLR5_3GPP:CFrequency
sets the analyzer to the default settings of the downlink carrier frequency measurement.

Related Commands :INSTrument[:SElect]

:CONFigure:SADLR5_3GPP|SAULR5_3GPP:CHPower (No Query Form)

Sets the analyzer to the default settings of the channel power measurement for 3GPP-R5. This command is equivalent to the following key sequence:

S/A key → **Standard...** side key → { **3GPP-R5-DL** | **3GPP-R5-UL** } side key
→ **PRESET** key → **Channel Power** side key

Syntax :CONFigure:SADLR5_3GPP|:SAULR5_3GPP:CHPower

Arguments None

Measurement Modes SADLR5_3G, SAULR5_3G

Examples :CONFigure:SADLR5_3GPP:CHPower
sets the analyzer to the default settings of the downlink channel power measurement.

Related Commands :INSTRument[:SElect]

:CONFigure:SADLR5_3GPP|SAULR5_3GPP:EBWidth (No Query Form)

Sets the analyzer to the default settings of the EBW (Emission Bandwidth) measurement for 3GPP-R5. This command is equivalent to the following key sequence:

S/A key → **Standard...** side key → { **3GPP-R5-DL** | **3GPP-R5-UL** } side key
→ **PRESET** key → **EBW** side key

Syntax :CONFigure:SADLR5_3GPP|:SAULR5_3GPP:EBWidth

Arguments None

Measurement Modes SADLR5_3G, SAULR5_3G

Examples :CONFigure:SADLR5_3GPP:EBWidth
sets the analyzer to the default settings of the downlink EBW measurement.

Related Commands :INSTRument[:SElect]

:CONFigure:SADLR5_3GPP:MCAClr (No Query Form)

Sets the analyzer to the default settings of the multi-carrier ACLR (Adjacent Channel Leakage Power Ratio) measurement in the 3GPP-R5 downlink analysis. This command is equivalent to the following key sequence:

S/A key → **Standard...** side key → **3GPP-R5-DL** side key → **PRESET** key → **MC-ACLR** side key

Syntax :CONFigure:SADLR5_3GPP:MCAClr

Arguments None

Measurement Modes SADLR5_3G

Examples :CONFigure:SADLR5_3GPP:MCAClr
sets the analyzer to the default settings of the multi-carrier ACLR measurement.

Related Commands :INSTrument[:SElect]

:CONFigure:SADLR5_3GPP|:SAULR5_3GPP:OBWidth (No Query Form)

Sets the analyzer to the default settings of the OBW (Occupied Bandwidth) measurement for 3GPP-R5. This command is equivalent to the following key sequence:

S/A key → **Standard...** side key → { **3GPP-R5-DL** | **3GPP-R5-UL** } side key → **PRESET** key → **OBW** side key

Syntax :CONFigure:SADLR5_3GPP|:SAULR5_3GPP:OBWidth

Arguments None

Measurement Modes SADLR5_3G, SAULR5_3G

Examples :CONFigure:SADLR5_3GPP:OBWidth
sets the analyzer to the default settings of the downlink OBW measurement.

Related Commands :INSTrument[:SElect]

:CONFigure:SADLR5_3GPP|:SAULR5_3GPP:SEMask (No Query Form)

Sets the analyzer to the default settings of the spectrum emission mask measurement for 3GPP-R5. This command is equivalent to the following key sequence:

S/A key → **Standard...** side key → { **3GPP-R5-DL** | **3GPP-R5-UL** } side key
→ **PRESET** key → **Spectrum Emission Mask** side key

Syntax :CONFigure:SADLR5_3GPP|:SAULR5_3GPP:SEMask

Arguments None

Measurement Modes SADLR5_3G, SAULR5_3G

Examples :CONFigure:SADLR5_3GPP:SEMask
sets the analyzer to the default settings of the downlink spectrum emission mask measurement.

Related Commands :INSTrument[:SElect]

:CONFigure:ULR5_3GPP Subgroup**3GPP-R5, Option 27 Only**

The :CONFigure:ULR5_3GPP commands set up the conditions related to the 3GPP-R5 uplink modulation analysis.

Command Tree	Header	Parameter
	:CONFigure	
	:ULR5_3GPP	

:CONFigure:ULR5_3GPP (No Query Form)

Sets the analyzer to the default settings of the 3GPP-R5 uplink modulation analysis. This command is equivalent to the following key sequence:

DEMOM key → **Standard...** side key → **3GPP-R5-UL** side key
→ **PRESET** key

Syntax	:CONFigure:ULR5_3GPP
Arguments	None
Measurement Modes	DEMULR5_3G
Examples	:CONFigure:ULR5_3GPP sets the analyzer to the default settings for the 3GPP-R5 uplink modulation measurements.
Related Commands	:INSTrument[:SElect]

:CONFigure:TD_SCDMA Subgroup

TD-SCDMA Analysis, Option 28 Only

The :CONFigure:DDEMod commands set up the conditions related to the TD-SCDMA analysis.

Command Tree	Header	Parameter
	:CONFigure	
	:TD_SCDMA	
	:ACLR	
	:CDPower	
	:CHPower	
	:IM	
	:MACCuracy	
	:OBWidth	
	:SEMask	
	:SFSummary	
	:STABLe	
	:TOMask	
	:TSSummary	

:CONFigure:TD_SCDMA:ACLR (No Query Form)

Sets the analyzer to the default settings for the ACLR measurement under the TD-SCDMA standard. Running this command is equivalent to pressing the following front-panel keys:

DEMOM key → **Standard...** side key → **TD-SCDMA** side key
→ **PRESET** key → **ACLR** side key

Syntax :CONFigure:TD_SCDMA:ACLR

Arguments None

Measurement Modes DEMTD_SCDMA

Examples :CONFigure:TD_SCDMA:ACLR
sets the analyzer to the default settings for the ACLR measurement.

Related Commands :INSTrument[:SElect]

:CONFigure:TD_SCDMA:CDPower (No Query Form)

Sets the analyzer to the default settings for the code domain power measurement under the TD-SCDMA standard. Running this command is equivalent to pressing the following front-panel keys:

DEMOM key → **Standard...** side key → **TD-SCDMA** side key
→ **PRESET** key → **Code Domain Power** side key

Syntax :CONFigure:TD_SCDMA:CDPower

Arguments None

Measurement Modes DEMTD_SCDMA

Examples :CONFigure:TD_SCDMA:CDPower
sets the analyzer to the default settings for the code domain power measurement.

Related Commands :INSTrument[:SElect]

:CONFigure:TD_SCDMA:CHPower (No Query Form)

Sets the analyzer to the default settings for the channel power measurement under the TD-SCDMA standard. Running this command is equivalent to pressing the following front-panel keys:

DEMOD key → **Standard...** side key → **TD-SCDMA** side key
→ **PRESET** key → **Channel Power** side key

Syntax :CONFigure:TD_SCDMA:CHPower

Arguments None

Measurement Modes DEMTD_SCDMA

Examples :CONFigure:TD_SCDMA:CHPower
sets the analyzer to the default settings for the channel power measurement.

Related Commands :INSTrument[:SElect]

:CONFigure:TD_SCDMA:IM (No Query Form)

Sets the analyzer to the default settings for the intermodulation measurement under the TD-SCDMA standard. Running this command is equivalent to pressing the following front-panel keys:

DEMOD key → **Standard...** side key → **TD-SCDMA** side key
→ **PRESET** key → **Intermodulation** side key

Syntax :CONFigure:TD_SCDMA:IM

Arguments None

Measurement Modes DEMTD_SCDMA

Examples :CONFigure:TD_SCDMA:IM
sets the analyzer to the default settings for the intermodulation measurement.

Related Commands :INSTrument[:SElect]

:CONFigure:TD_SCDMA:MACCuracy (No Query Form)

Sets the analyzer to the default settings for the modulation accuracy measurement under the TD-SCDMA standard. Running this command is equivalent to pressing the following front-panel keys:

DEMODO key → **Standard...** side key → **TD-SCDMA** side key
→ **PRESET** key → **Modulation Accuracy** side key

Syntax	:CONFigure:TD_SCDMA:MACCuracy
Arguments	None
Measurement Modes	DEMTD_SCDMA
Examples	:CONFigure:TD_SCDMA:MACCuracy sets the analyzer to the default settings for the modulation accuracy measurement.
Related Commands	:INSTrument[:SElect]

:CONFigure:TD_SCDMA:OBWidth (No Query Form)

Sets the analyzer to the default settings for the OBW (Occupied Bandwidth) measurement under the TD-SCDMA standard. Running this command is equivalent to pressing the following front-panel keys:

DEMODO key → **Standard...** side key → **TD-SCDMA** side key
→ **PRESET** key → **OBW** side key

Syntax	:CONFigure:TD_SCDMA:OBWidth
Arguments	None
Measurement Modes	DEMTD_SCDMA
Examples	:CONFigure:TD_SCDMA:OBWidth sets the analyzer to the default settings for the OBW measurement.
Related Commands	:INSTrument[:SElect]

:CONFigure:TD_SCDMA:SEMask (No Query Form)

Sets the analyzer to the default settings for the spectrum emission mask measurement under the TD-SCDMA standard. Running this command is equivalent to pressing the following front-panel keys:

DEMODO key → **Standard...** side key → **TD-SCDMA** side key
→ **PRESET** key → **Spectrum Emission Mask** side key

Syntax :CONFigure:TD_SCDMA:SEMask

Arguments None

Measurement Modes DEMTD_SCDMA

Examples :CONFigure:TD_SCDMA:SEMask
sets the analyzer to the default settings for the spectrum emission mask measurement.

Related Commands :INSTrument[:SElect]

:CONFigure:TD_SCDMA:SFSummary (No Query Form)

Sets the analyzer to the default settings for the subframe summary measurement under the TD-SCDMA standard. Running this command is equivalent to pressing the following front-panel keys:

DEMODO key → **Standard...** side key → **TD-SCDMA** side key
→ **PRESET** key → **Subframe Summary** side key

Syntax :CONFigure:TD_SCDMA:SFSummary

Arguments None

Measurement Modes DEMTD_SCDMA

Examples :CONFigure:TD_SCDMA:SFSummary
sets the analyzer to the default settings for the subframe summary measurement.

Related Commands :INSTrument[:SElect]

:CONFigure:TD_SCDMA:STABLE (No Query Form)

Sets the analyzer to the default settings for the symbol table under the TD-SCDMA standard. Running this command is equivalent to pressing the following front-panel keys:

DEMOD key → **Standard...** side key → **TD-SCDMA** side key
→ **PRESET** key → **Symbol Table** side key

Syntax :CONFigure:TD_SCDMA:STABLE

Arguments None

Measurement Modes DEMTD_SCDMA

Examples :CONFigure:TD_SCDMA:STABLE
sets the analyzer to the default settings for the symbol table.

Related Commands :INSTrument[:SElect]

:CONFigure:TD_SCDMA:TOOMask (No Query Form)

Sets the analyzer to the default settings for the transmit on/off mask measurement under the TD-SCDMA standard. Running this command is equivalent to pressing the following front-panel keys:

DEMOD key → **Standard...** side key → **TD-SCDMA** side key
→ **PRESET** key → **Transmit On/Off Mask** side key

Syntax :CONFigure:TD_SCDMA:TOOMask

Arguments None

Measurement Modes DEMTD_SCDMA

Examples :CONFigure:TD_SCDMA:TOOMask
sets the analyzer to the default settings for the transmit on/off mask measurement.

Related Commands :INSTrument[:SElect]

:CONFigure:TD_SCDMA:TSSummary (No Query Form)

Sets the analyzer to the default settings for the timeslot summary under the TD-SCDMA standard. Running this command is equivalent to pressing the following front-panel keys:

DEMOD key → **Standard...** side key → **TD-SCDMA** side key
→ **PRESET** key → **Timeslot Summary** side key

Syntax :CONFigure:TD_SCDMA:TSSummary

Arguments None

Measurement Modes DEMTD_SCDMA

Examples :CONFigure:TD_SCDMA:TSSummary
Sets the analyzer to the default settings for the timeslot summary.

Related Commands :INSTRument[:SElect]

:CONFigure:M2WLAN Subgroup*WLAN, Option 29 Only*

The :CONFigure:M2WLAN commands set up the conditions for the IEEE802.11n MIMO (2x2) analysis.

Command Tree	Header	Parameter
	:CONFigure	
	:M2WLAN	

:CONFigure:M2WLAN (No Query Form)

Sets the analyzer to the default settings for the 802.11n MIMO (2x2) modulation measurement. Running this command is equivalent to pressing the following front-panel keys:

DEMOD key → **Standard...** side key → **802.11n MIMO (2x2)** side key
→ **PRESET** key → **EVM vs Time** side key

Syntax :CONFigure:M2WLAN

Arguments None

Measurement Modes DEMM2WLAN

Examples :CONFigure:M2WLAN
sets the analyzer to the default settings for the MIMO (2x2) modulation measurement.

Related Commands :INSTrument[:SElect]

:CONFigure:SWLAN Subgroup

WLAN, Option 29 Only

The :CONFigure:SWLAN commands set up the conditions for the IEE802.11n (nx1) analysis.

Command Tree	Header	Parameter
	:CONFigure	
	:SWLAN	
	:SMASK	

:CONFigure:SWLAN (No Query Form)

Sets the analyzer to the default settings for the 802.11n (nx1) modulation measurement. Running this command is equivalent to pressing the following front-panel keys:

DEMODO key → **Standard...** side key → **802.11n (nx1)** side key
→ **PRESET** key → **EVM vs Time** side key

Syntax	:CONFigure:SWLAN
Arguments	None
Measurement Modes	DEMSWLAN
Examples	:CONFigure:SWLAN sets the analyzer to the default settings for the nx1 modulation measurement.
Related Commands	:INSTrument[:SElect]

:CONFigure:SWLAN:SMASK (No Query Form)

Sets the analyzer to the default setting for Spectrum Mask measurement in the 802.11n (nx1) analysis.

DEMODO key → **Standard...** side key → **802.11n (nx1)** side key
→ **PRESET** key → **Spectrum Mask** side key

Syntax	:CONFigure:SWLAN:SMASK
Arguments	None
Measurement Modes	DEMSWLAN
Examples	:CONFigure:SWLAN:SMASK Sets the analyzer to the default setting for Spectrum Mask measurement in the 802.11n (nx1) analysis.
Related Commands	:INSTrument[:SElect]

:CONFigure:WLAN Subgroup

WLAN, Option 29 Only

The :CONFigure:WLAN commands set up the conditions related to the IEEE802.11a/b/g analysis.

Command Tree	Header	Parameter
	:CONFigure	
	:WLAN	
	:SMASK	
	:TPOWer	

:CONFigure:WLAN (No Query Form)

Sets the analyzer to the default settings for IEEE802.11a/b/g modulation measurement. Running this command is equivalent to pressing the following front-panel keys:

DEMOD key → **Standard...** side key → **IEEE802.11a/b/g** side key
→ **PRESET** key → **EVM vs Time** side key

Syntax	:CONFigure:WLAN
Arguments	None
Measurement Modes	DEM WLAN
Examples	:CONFigure:WLAN sets the analyzer to the default settings for WLAN modulation measurement.
Related Commands	:INSTrument[:SElect]

:CONFigure:WLAN:SMASk (No Query Form)

Sets the analyzer to the default setting for Spectrum Mask measurement in the IEEE802.11a/b/g analysis.

DEMOD key → **Standard...** side key → **IEEE802.11a/b/g** side key
→ **PRESET** key → **Spectrum Mask** side key

Syntax :CONFigure:WLAN:SMASk

Arguments None

Measurement Modes DEMWLAN

Examples :CONFigure:WLAN:SMASk
Sets the analyzer to the default setting for Spectrum Mask measurement.

Related Commands :INSTrument[:SElect]

:CONFigure:WLAN:TPOWer (No Query Form)

Sets the analyzer to the default setting for Transmit Power measurement in the IEEE802.11a/b/g analysis..

DEMOD key → **Standard...** side key → **IEEE802.11a/b/g** side key
→ **PRESET** key → **Transmit Power** side key

Syntax :CONFigure:WLAN:TPOWer

Arguments None

Measurement Modes DEMWLAN

Examples :CONFigure:WLAN:TPOWer
Sets the analyzer to the default setting for Transmit Power measurement.

Related Commands :INSTrument[:SElect]

:CONFigure:DLR6_3GPP Subgroup

3GPP-R6, Option 40 Only

The :CONFigure:DLR6_3GPP commands set up the conditions related to the 3GPP-R6 downlink modulation analysis.

Command Tree	Header	Parameter
	:CONFigure	
	:DLR6_3GPP	

:CONFigure:DLR6_3GPP (No Query Form)

Sets the analyzer to the default settings for the 3GPP-R6 downlink modulation analysis. This command is equivalent to the following key sequence:

DEMOD key → **Standard...** side key → **3GPP-R6-DL** side key
→ **PRESET** key

Syntax :CONFigure:DLR6_3GPP

Arguments None

Measurement Modes DEMDLR6_3G

Examples :CONFigure:DLR6_3GPP
sets the analyzer to the default settings for the 3GPP-R6 downlink modulation analysis.

Related Commands :INSTrument[:SElect]

:CONFigure:ULR6_3GPP Subgroup**3GPP-R6, Option 40 Only**

The :CONFigure:ULR6_3GPP commands set up the conditions related to the 3GPP-R6 uplink modulation analysis.

Command Tree	Header	Parameter
	:CONFigure	
	:ULR6_3GPP	

:CONFigure:ULR6_3GPP (No Query Form)

Sets the analyzer to the default settings of the 3GPP-R6 uplink modulation analysis. This command is equivalent to the following key sequence:

DEMOM key → **Standard...** side key → **3GPP-R6-UL** side key
→ **PRESET** key

Syntax	:CONFigure:ULR6_3GPP
Arguments	None
Measurement Modes	DEMULR6_3G
Examples	:CONFigure:ULR6_3GPP sets the analyzer to the default settings of the 3GPP-R6 uplink modulation analysis.
Related Commands	:INSTrument[:SElect]

:DISPlay Commands

The :DISPlay commands control how to show measurement data on the screen. These commands are divided into the following subgroups:

Table 2-37: :DISPlay command subgroups

Command header	Function	Refer to :
:DISPlay:CCDF	Controls display of the CCDF analysis.	page 2-186
:DISPlay:OVlew	Controls the Demod/Time mode overview.	page 2-192
:DISPlay:PULSe:MVlew :SVlew	Controls the main/sub view in the pulse characteristics analysis.	page 2-204
:DISPlay:PULSe:SPECTrum	Controls the spectrum view in the pulse characteristics analysis.	page 2-214
:DISPlay:PULSe:WAVEform	Controls the time domain view in the pulse characteristics analysis.	page 2-219
:DISPlay:TFRrequency	Controls the spectrogram view.	page 2-233
:DISPlay[:VIEW]	Sets the display brightness and format.	page 2-242
:DISPlay:WAVEform	Controls the time domain view.	page 2-245

NOTE. The :DISPlay commands change the measurement display only, and do not affect the analyzer hardware settings.

Note on Horizontal Scaling

You can expand an acquired waveform vertically and horizontally on screen (but not contract). Use the :DISPlay commands containing :X[:SCALE] or :Y[:SCALE] node to set the expansion range. Refer to each command description for the setting range. Additionally, meet the following requirements for setting the horizontal scale.

The horizontal display range set by the :DISPlay commands must be within the data acquisition range set by the :SENSe commands (see Figure 2-6):

$$\begin{aligned} X_{START} &\leq X_{MIN} < X_{STOP} \\ X_{MAX} &\leq X_{STOP} \end{aligned}$$

Where

- X_{START}: the beginning of data acquisition range
- X_{STOP}: the end of data acquisition range
- X_{MIN}: the beginning of data expansion range
- X_{MAX}: the end of data expansion range

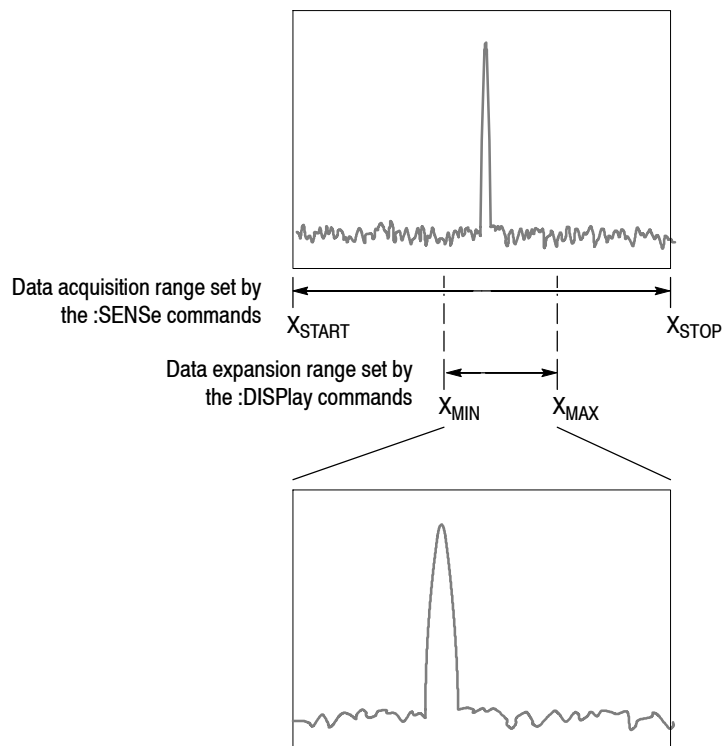

Figure 2-6: Horizontal scale setting requirements

The :DISPlay commands containing the :X[:SCALE] node must meet the above requirements. Figure 2-7 shows an example of the spectrum view. The horizontal scale setting requirements are:

$$\begin{aligned} \text{CENTer} - \text{SPAN}/2 &\leq \text{OFFSet} < \text{CENTer} + \text{SPAN}/2 \\ \text{OFFSet} + 10 * \text{PDIV} &\leq \text{CENTer} + \text{SPAN}/2 \end{aligned}$$

Where

CENTer: [:SENSe]:FREQuency:CENTer value

SPAN: [:SENSe]:FREQuency:SPAN value

OFFSet: :DISPlay:SPECTrum:X[:SCALE]:OFFSet value

PDIVision: :DISPlay:SPECTrum:X[:SCALE]:PDIVision value

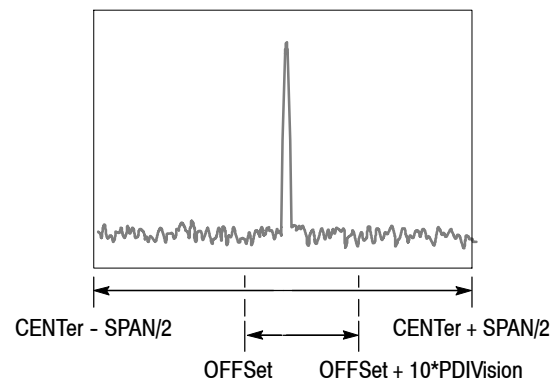
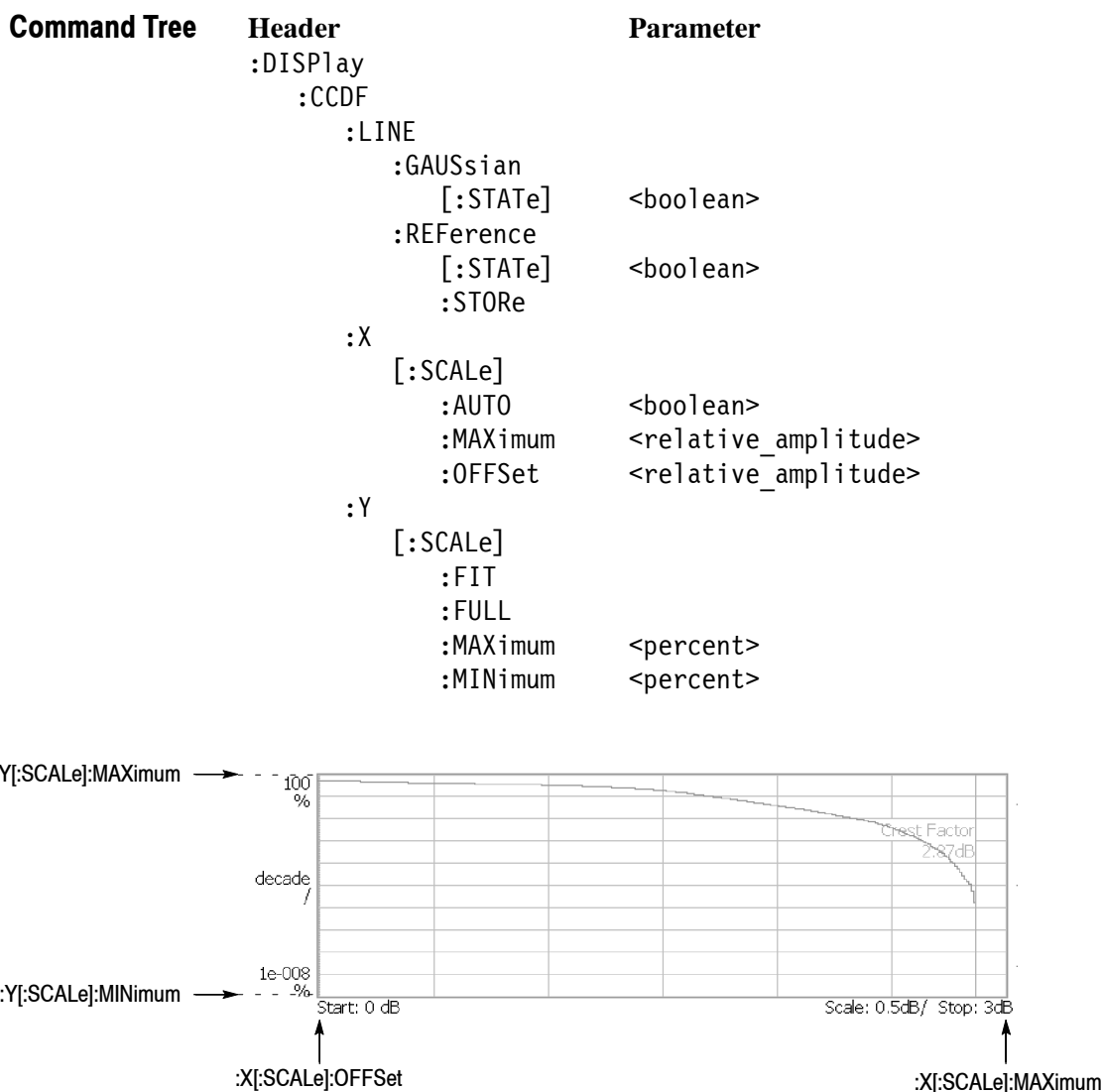

Figure 2-7: Horizontal scale setting requirements for spectrum view

:DISPlay:CCDF Subgroup

The :DISPlay:CCDF commands control the CCDF view.

NOTE. To use a command from this group, you must have selected TIMCCDF in the :INSTrument[:SElect] command.



NOTE: Command header :DISPlay:CCDF is omitted here.

Figure 2-8: :DISPlay:CCDF command setting

:DISPlay:CCDF:LINE:GAUSSian[:STATe](?)

Determines whether to show the Gaussian line in the CCDF view.

Syntax :DISPlay:CCDF:LINE:GAUSSian[:STATe] { OFF | ON | 0 | 1 }
:DISPlay:CCDF:LINE:GAUSSian[:STATe]?

Arguments OFF or 0 hides the Gaussian line.
ON or 1 shows the Gaussian line in the CCDF view.

Measurement Modes TIMCCDF

Examples :DISPlay:CCDF:LINE:GAUSSian:STATe ON
shows the Gaussian line in the CCDF view.

:DISPlay:CCDF:LINE:REFerence[:STATe](?)

Selects whether to show the reference line in the CCDF view. The reference line is stored with the :DISPlay:CCDF:LINE:REFerence:STORe command.

Syntax :DISPlay:CCDF:LINE:REFerence[:STATe] { OFF | ON | 0 | 1 }
:DISPlay:CCDF:LINE:REFerence[:STATe]?

Arguments OFF or 0 hides the reference line.
ON or 1 shows the reference line in the CCDF view.

Measurement Modes TIMCCDF

Examples :DISPlay:CCDF:LINE:REFerence:STATe ON
shows the reference line in the CCDF view.

Related Commands :DISPlay:CCDF:LINE:REFerence:STORe

:DISPlay:CCDF:LINE:REFeRence:STORe (No Query Form)

Stores the current CCDF trace as a new reference line and automatically enables the reference line display.

Syntax :DISPlay:CCDF:LINE:REFeRence:STORe

Arguments None

Measurement Modes TIMCCDF

Examples :DISPlay:CCDF:LINE:REFeRence:STORe
stores the current CCDF trace as a new reference line.

Related Commands :DISPlay:CCDF:LINE:REFeRence[:STATe]

:DISPlay:CCDF:X[:SCALe]:AUTO(?)

Determines whether to automatically set the horizontal, or power, scale in the CCDF view.

Syntax :DISPlay:CCDF:X[:SCALe]:AUTO { OFF | ON | 0 | 1 }
:DISPlay:CCDF:X[:SCALe]:AUTO?

Arguments OFF or 0 specifies that the horizontal scale is set manually. Use the :DISPlay:CCDF:X[:SCALe]:MAXimum and the :DISPlay:CCDF:X[:SCALe]:OFFSet commands, detailed below, to set the horizontal axis.

ON or 1 specifies that the horizontal scale is set automatically (default).

Measurement Modes TIMCCDF

Examples :DISPlay:CCDF:X:SCALe:AUTO ON
specifies that the horizontal scale is set automatically.

Related Commands :DISPlay:CCDF:X[:SCALe]:MAXimum, :DISPlay:CCDF:X[:SCALe]:OFFSet

:DISPlay:CCDF:X[:SCALe]:MAXimum(?)

Sets or queries the maximum horizontal, or power, value (right edge) in the CCDF view.

Syntax :DISPlay:CCDF:X[:SCALe]:MAXimum <rel_amp1>
:DISPlay:CCDF:X[:SCALe]:MAXimum?

Arguments <rel_amp1>::=<NRf> specifies the maximum horizontal value.
Range: 1 to 100 dB

Measurement Modes TIMCCDF

Examples :DISPlay:CCDF:X:SCALe:MAXimum 15
sets the maximum horizontal value to 15 dB.

Related Commands :DISPlay:CCDF:X[:SCALe]:AUTO

:DISPlay:CCDF:X[:SCALe]:OFFSet(?)

Sets or queries the start value of the horizontal axis in the CCDF view.

Syntax :DISPlay:CCDF:X[:SCALe]:OFFSet <rel_amp1>
:DISPlay:CCDF:X[:SCALe]:OFFSet?

Arguments <rel_amp1>::=<NRf> specifies the start value of the horizontal axis.
Range: 0 to [(Maximum horizontal value) - (Horizontal full scale)] dB

Measurement Modes TIMCCDF

Examples :DISPlay:CCDF:X:SCALe:OFFSet 5
sets the start value of the horizontal axis to 5 dB.

Related Commands :DISPlay:CCDF:X[:SCALe]:AUTO

:DISPlay:CCDF:Y[:SCALe]:FIT (No Query Form)

Runs auto-scale on the CCDF view. The auto-scale automatically sets the start value and scale of the vertical axis to display the whole waveform.

Syntax :DISPlay:CCDF:Y[:SCALe]:FIT

Arguments None

Measurement Modes TIMCCDF

Examples :DISPlay:CCDF:Y:SCALe:FIT
runs auto-scale on the CCDF view.

:DISPlay:CCDF:Y[:SCALe]:FULL (No Query Form)

Sets the vertical axis to the default full-scale value in the CCDF view.

Syntax :DISPlay:CCDF:Y[:SCALe]:FULL

Arguments None

Measurement Modes TIMCCDF

Examples :DISPlay:CCDF:Y:SCALe:FULL
sets the vertical axis to the default full-scale value in the CCDF view.

:DISPlay:CCDF:Y[:SCALE]:MAXimum(?)

Sets or queries the maximum vertical value (top) in the CCDF view.

Syntax :DISPlay:CCDF:Y[:SCALE]:MAXimum <value>
:DISPlay:CCDF:Y[:SCALE]:MAXimum?

Arguments <value>::=<NRf> sets the maximum vertical value. Range: 10⁻⁹ to 100%.

Measurement Modes TIMCCDF

Examples :DISPlay:CCDF:Y:SCALE:MAXimum 80
sets the maximum vertical value to 80%.

:DISPlay:CCDF:Y[:SCALE]:MINimum(?)

Sets or queries the minimum vertical value (bottom) in the CCDF view.

Syntax :DISPlay:CCDF:Y[:SCALE]:MINimum <value>
:DISPlay:CCDF:Y[:SCALE]:MINimum?

Arguments <value>::=<NRf> sets the minimum vertical value. Range: 10⁻⁹ to 100%.

Measurement Modes TIMCCDF

Examples :DISPlay:CCDF:Y:SCALE:MINimum 20
sets the minimum vertical value to 20%.

:DISPlay:OView Subgroup

The :DISPlay:OView commands set up the overview in the Demod (modulation analysis) and Time (time analysis) modes and the spectrogram in the real-time spectrum analysis with zoom function.

NOTE. The :DISPlay:OView:ZOOM commands are valid when :INSTRument [:SElect] is set to SAZRTIME (real-time spectrum analysis with zoom function) or DEMRFID (RFID analysis, Option 21).

Command Tree	Header	Parameter
	:DISPlay	
	:OView	
	:FORMat	WAVEform SGRam ZOOM
	:OTINdicator	<boolean>
	:SGRam	
	:COLor	
	[:SCALE]	
	:OFFSet	<amplitude>
	:RANge	<relative_amplitude>
	:X	
	[:SCALE]	
	:OFFSet	<frequency>
	:SPAN	<frequency>
	:Y	
	[:SCALE]	
	:OFFSet	<frame_count>
	:PLINe	<frame_count>
	:WAVEform	
	:X	
	[:SCALE]	
	:OFFSet	<time>
	:PDIVision	<time>
	:Y	
	[:SCALE]	
	:FIT	
	:FULL	
	:OFFSet	<amplitude>
	:PDIVision	<amplitude>
	:ZOOM	
	:COLor	
	[:SCALE]	
	:OFFSet	<amplitude>
	:RANge	<relative_amplitude>

```

:X
[:SCALE]
:OFFSet <frequency>
:SPAN <frequency>

:Y
[:SCALE]
:OFFSet <frame_count>
:PLINe <frame_count>
    
```

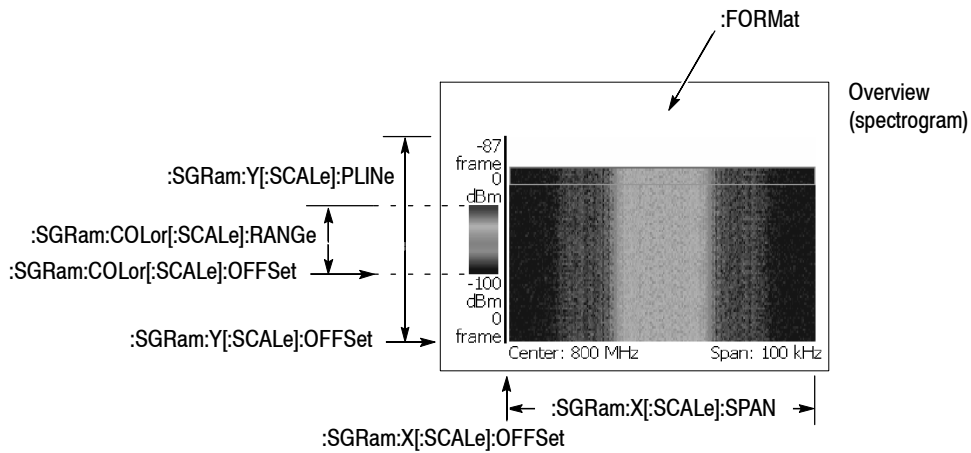
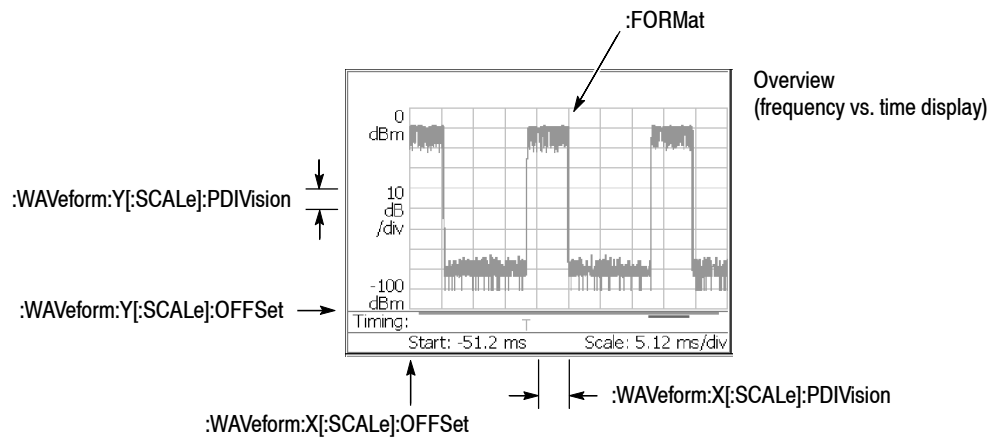

NOTE: Command header :DISPlay:OVlew is omitted here.

Figure 2-9: :DISPlay:OVlew command setting

:DISPlay:OVlew:FORMat(?)

Selects or queries the overview display format.

Syntax :DISPlay:OVlew:FORMat { WAVEform | SGRam | ZOOM }
 :DISPlay:OVlew:FORMat?

Arguments WAVEform displays the amplitude vs. time view.
 SGRam displays the spectrogram.
 ZOOM displays the spectrogram with zoom function.

NOTE. ZOOM is valid when :INSTRument[:SElect] is set to DEMRFID (Option 21 RFID analysis).

Measurement Modes All Demod modes, all Time modes

Examples :DISPlay:OVlew:FORMat SGRam
 displays the spectrogram view in the overview.

:DISPlay:OVlew:OTINdicator(?)

Determines whether to show the trigger output indicator (“O”) in the overview.

Syntax :DISPlay:OVlew:OTINdicator { OFF | ON | 0 | 1 }
 :DISPlay:OVlew:OTINdicator?

Arguments OFF or 0 hides the trigger output indicator.
 ON or 1 shows the trigger output indicator.

Measurement Modes All Demod modes, all Time modes

Examples :DISPlay:OVlew:OTINdicator ON
 shows the trigger output indicator.

:DISPlay:OView:SGRam:COLor[:SCALe]:OFFSet(?)

Sets or queries the minimum value (bottom) of the color, or amplitude, axis when the overview displays a spectrogram.

Syntax :DISPlay:OView:SGRam:COLor[:SCALe]:OFFSet <amp1>
 :DISPlay:OView:SGRam:COLor[:SCALe]:OFFSet?

Arguments <amp1>::=<NRf> specifies the minimum color-axis value in the overview.
 Range: -200 to +100 dBm.

Measurement Modes All Demod modes, all Time modes

Examples :DISPlay:OView:SGRam:COLor:SCALe:OFFSet -100
 sets the minimum color-axis value to -100 dBm.

:DISPlay:OView:SGRam:COLor[:SCALe]:RANGe(?)

Sets or queries full-scale value of the color, or amplitude, axis when the overview displays a spectrogram.

Syntax :DISPlay:OView:SGRam:COLor[:SCALe]:RANGe <rel_amp1>
 :DISPlay:OView:SGRam:COLor[:SCALe]:RANGe?

Arguments <rel_amp1>::={ 10 | 20 | 50 | 100 } [dB] specifies the full-scale value of the color axis.

Measurement Modes All Demod modes, all Time modes

Examples :DISPlay:OView:SGRam:COLor:SCALe:RANGe 100
 sets full-scale value of the color axis to 100 dB.

:DISPlay:OView:SGRam:X[:SCALe]:OFFSet(?)

Sets or queries the minimum horizontal, or frequency, value (left edge) when the overview displays a spectrogram.

Syntax :DISPlay:OView:SGRam:X[:SCALe]:OFFSet <freq>
 :DISPlay:OView:SGRam:X[:SCALe]:OFFSet?

Arguments <freq>::=<NRf> specifies the minimum horizontal value of the spectrogram. Refer to *Note on Horizontal Scaling* on page 2-184 for setting the scale.

Measurement Modes All Demod modes, all Time modes

Examples :DISPlay:OView:SGRam:X:SCALe:OFFSet 100MHz
 sets the minimum horizontal value to 100 MHz.

:DISPlay:OView:SGRam:X[:SCALe]:SPAN(?)

Sets or queries the span of the horizontal, or frequency, axis when the overview displays a spectrogram.

Syntax :DISPlay:OView:SGRam:X[:SCALe]:SPAN <freq>
 :DISPlay:OView:SGRam:X[:SCALe]:SPAN?

Arguments <freq>::=<NRf> specifies the horizontal span. Refer to *Note on Horizontal Scaling* on page 2-184 for setting the scale.

Measurement Modes All Demod modes, all Time modes

Examples :DISPlay:OView:SGRam:X:SCALe:SPAN 100kHz
 sets the span to 100 kHz.

:DISPlay:OView:SGRam:Y[:SCALe]:OFFSet(?)

Sets or queries the minimum vertical, or frame number, value (bottom) when the overview displays a spectrogram.

Syntax :DISPlay:OView:SGRam:Y[:SCALe]:OFFSet <value>
:DISPlay:OView:SGRam:Y[:SCALe]:OFFSet?

Arguments <value>::=<NR1> specifies the minimum vertical value of the spectrogram.
Range: Frame # -63999 to 0.

Measurement Modes All Demod modes, all Time modes

Examples :DISPlay:OView:SGRam:Y:SCALe:OFFSet -100
sets the minimum vertical value to frame # -100.

:DISPlay:OView:SGRam:Y[:SCALe]:PLINe(?)

Sets or queries the vertical scale (the number of frames per line) when the overview displays a spectrogram.

Frames are thinned out from all the acquired framed data at intervals of the number of frames specified in this command, before the spectrogram is displayed. For example, if you set the argument to 5, the data will be displayed every 5 frames.

Syntax :DISPlay:OView:SGRam:Y[:SCALe]:PLINe <value>
:DISPlay:OView:SGRam:Y[:SCALe]:PLINe?

Arguments <value>::=<NR1> specifies the vertical scale for the spectrogram.
Range: 1 to 1024 frames per line.

Measurement Modes All Demod modes, all Time modes

Examples :DISPlay:OView:SGRam:Y:SCALe:PLINe 5
displays the data in the spectrogram every 5 frames.

:DISPlay:OView:WAVeform:X[:SCALe]:OFFSet(?)

Sets or queries the minimum horizontal, or time, value (left edge) when the overview displays an amplitude vs. time waveform.

Syntax :DISPlay:OView:WAVeform:X[:SCALe]:OFFSet <time>
 :DISPlay:OView:WAVeform:X[:SCALe]:OFFSet?

Arguments <time>::=<Nrf> specifies the minimum horizontal value. Range: -32000 to 0 s. Refer to *Note on Horizontal Scaling* on page 2-184 for setting the scale.

Measurement Modes All Demod modes, all Time modes

Examples :DISPlay:OView:WAVeform:X:SCALe:OFFSet -100us
 sets the minimum horizontal value to -100 μ s.

:DISPlay:OView:WAVeform:X[:SCALe]:PDIVision(?)

Sets or queries the horizontal, or time, scale (per division) when the overview displays an amplitude vs. time view.

Syntax :DISPlay:OView:WAVeform:X[:SCALe]:PDIVision <time>
 :DISPlay:OView:WAVeform:X[:SCALe]:PDIVision?

Arguments <time>::=<Nrf> specifies the horizontal scale. Range: 0 to 3200 s/div. Refer to *Note on Horizontal Scaling* on page 2-184 for setting the scale.

Measurement Modes All Demod modes, all Time modes

Examples :DISPlay:OView:WAVeform:X:SCALe:PDIVision 10.0E-6
 sets the horizontal scale to 10 μ s/div.

:DISPlay:OView:WAVeform:Y[:SCALe]:FIT (No Query Form)

Runs the auto-scale on the overview. The auto-scale automatically sets the start value and scale of the vertical axis to display the whole waveform.

Syntax :DISPlay:OView:WAVeform:Y[:SCALe]:FIT

Arguments None

Measurement Modes All Demod modes, all Time modes

Examples :DISPlay:OView:WAVeform:Y:SCALe:FIT
runs the auto-scale on the overview.

:DISPlay:OView:WAVeform:Y[:SCALe]:FULL (No Query Form)

Sets the vertical axis in the overview to the default full-scale value.

Syntax :DISPlay:OView:WAVeform:Y[:SCALe]:FULL

Arguments None

Measurement Modes All Demod modes, all Time modes

Examples :DISPlay:OView:WAVeform:Y:SCALe:FULL
sets the overview's vertical axis to the default full-scale value.

:DISPlay:OVlew:WAVeform:Y[:SCALe]:OFFSet(?)

Sets or queries the minimum vertical, or amplitude, value (bottom) when the overview displays an amplitude vs. time waveform.

Syntax :DISPlay:OVlew:WAVeform:Y[:SCALe]:OFFSet <amp1>
 :DISPlay:OVlew:WAVeform:Y[:SCALe]:OFFSet?

Arguments <amp1>::=<NRf> specifies the minimum vertical value.
 Range: -200 to 0 dBm.

Measurement Modes SAZRTIME, DEMRFID

Examples :DISPlay:OVlew:WAVeform:Y:SCALe:OFFSet -100
 sets the minimum vertical value to -100 dBm.

:DISPlay:OVlew:WAVeform:Y[:SCALe]:PDIVision(?)

Sets or queries the vertical, or amplitude, scale (per division) when the overview displays an amplitude vs. time waveform.

Syntax :DISPlay:OVlew:WAVeform:Y[:SCALe]:PDIVision <amp1>
 :DISPlay:OVlew:WAVeform:Y[:SCALe]:PDIVision?

Arguments <amp1>::=<NRf> specifies the vertical scale. Range: 0 to 30 dB/div.

Measurement Modes SAZRTIME, DEMRFID

Examples :DISPlay:OVlew:WAVeform:Y:SCALe:PDIVision 10
 sets the vertical scale to 10 dB/div.

:DISPlay:OView:ZOOM:COLor[:SCALe]:OFFSet(?)

Sets or queries the minimum value (bottom) of the color, or amplitude, axis of the spectrogram with zoom function.

Syntax :DISPlay:OView:ZOOM:COLor[:SCALe]:OFFSet <amp1>
 :DISPlay:OView:ZOOM:COLor[:SCALe]:OFFSet?

Arguments <amp1>::=<NRf> specifies the minimum color-axis value of the spectrogram with zoom function. Range: -200 to +100 dBm.

Measurement Modes SAZRTIME, DEMRFID

Examples :DISPlay:OView:ZOOM:COLor:SCALe:OFFSet -100
 sets the minimum color-axis value to -100 dBm.

:DISPlay:OView:ZOOM:COLor[:SCALe]:RANGe(?)

Sets or queries full-scale value of the color, or amplitude, axis of the spectrogram with zoom function.

Syntax :DISPlay:OView:ZOOM:COLor[:SCALe]:RANGe <rel_amp1>
 :DISPlay:OView:ZOOM:COLor[:SCALe]:RANGe?

Arguments <rel_amp1>::={ 10 | 20 | 50 | 100 } [dB] specifies the full-scale value of the color axis of the spectrogram with zoom function.

Measurement Modes SAZRTIME, DEMRFID

Examples :DISPlay:OView:ZOOM:COLor:SCALe:RANGe 100
 sets full-scale value of the color axis to 100 dB.

:DISPlay:OVlew:ZOOM:X[:SCALe]:OFFSet(?)

Sets or queries the minimum horizontal, or frequency, value (left edge) of the spectrogram with zoom function.

Syntax :DISPlay:OVlew:ZOOM:X[:SCALe]:OFFSet <freq>

 :DISPlay:OVlew:ZOOM:X[:SCALe]:OFFSet?

Arguments <freq>::=<NRf> specifies the minimum horizontal value of the spectrogram with zoom function. Refer to *Note on Horizontal Scaling* on page 2-184 for setting the scale.

Measurement Modes SAZRTIME, DEMRFID

Examples :DISPlay:OVlew:ZOOM:X:SCALe:OFFSet 100MHz
 sets the minimum horizontal value to 100 MHz.

:DISPlay:OVlew:ZOOM:X[:SCALe]:SPAN(?)

Sets or queries the span of the horizontal, or frequency, axis of the spectrogram with zoom function.

Syntax :DISPlay:OVlew:ZOOM:X[:SCALe]:SPAN <freq>

 :DISPlay:OVlew:ZOOM:X[:SCALe]:SPAN?

Arguments <freq>::=<NRf> specifies the horizontal span of the spectrogram with zoom function. Refer to *Note on Horizontal Scaling* on page 2-184 for setting the scale.

Measurement Modes SAZRTIME, DEMRFID

Examples :DISPlay:OVlew:ZOOM:X:SCALe:SPAN 100kHz
 sets the span to 100 kHz.

:DISPlay:OView:ZOOM:Y[:SCALe]:OFFSet(?)

Sets or queries the minimum vertical, or frame number, value (bottom) of the spectrogram with zoom function.

Syntax :DISPlay:OView:ZOOM:Y[:SCALe]:OFFSet <value>

:DISPlay:OView:ZOOM:Y[:SCALe]:OFFSet?

Arguments <value>::=<NR1> specifies the minimum vertical value of the spectrogram with zoom function. Range: Frame # -63999 to 0.

Measurement Modes SAZRTIME, DEMRFID

Examples :DISPlay:OView:ZOOM:Y:SCALe:OFFSet -100
sets the minimum vertical value to frame # -100.

:DISPlay:OView:ZOOM:Y[:SCALe]:PLINe(?)

Sets or queries the vertical scale (the number of frames per line) of the spectrogram with zoom function.

Frames are thinned out from all the acquired framed data at intervals of the number of frames specified in this command, before the spectrogram is displayed. For example, if you set the argument to 5, the data will be displayed every 5 frames.

Syntax :DISPlay:OView:ZOOM:Y[:SCALe]:PLINe <value>

:DISPlay:OView:ZOOM:Y[:SCALe]:PLINe?

Arguments <value>::=<NR1> specifies the vertical scale for the spectrogram with zoom function. Range: 1 to 1024 frames per line.

Measurement Modes SAZRTIME, DEMRFID

Examples :DISPlay:OView:ZOOM:Y:SCALe:PLINe 5
displays the data in the spectrogram every 5 frames.

:DISPlay:PULSe:MView|:SVIew Subgroup

The :DISPlay:PULSe:MView|:SVIew commands control display of the main view (pulse result table) and subview in the pulse characteristics analysis.

NOTE. To use a command from this group, you must have selected *TIMPULSE* (pulse characteristics analysis) in the :INSTRument[:SElect] command.

Command Tree	Header	Parameter
	:DISPlay	
	:PULSe	
	:MView	
	:RESult	
	:CHPower	<boolean>
	:DCYClE	<boolean>
	:EBWidth	<boolean>
	:FREQuency	<boolean>
	:OBWidth	<boolean>
	:OORatio	<boolean>
	:PERiod	<boolean>
	:PHASe	<boolean>
	:PPOWer	<boolean>
	:RIPPlE	<boolean>
	:WIDTh	<boolean>
	:SVIew	
	:FORMat	WIDTh PPOWer OORatio RIPPlE PERiod DCYClE PHASe CHPower OBWidth EBWidth FREQuency
	:GUIDelines	<boolean>
	:RANGe	ADAPtive MAXimum
	:RESult	SINGle ALL
	:SElect	<numeric_value>

:DISPlay:PULSe:MVIew:RESult:CHPower(?)

Determines whether to show channel power measurement results in the pulse result table.

Syntax :DISPlay:PULSe:MVIew:RESult:CHPower { 0 | 1 | OFF | ON }
:DISPlay:PULSe:MVIew:RESult:CHPower?

Arguments OFF or 0 hides channel power measurement results in the pulse result table.
ON or 1 shows channel power measurement results in the pulse result table.

Measurement Modes TIMPULSE

Examples :DISPlay:PULSe:MVIew:RESult:CHPower ON
shows channel power measurement results in the pulse result table.

:DISPlay:PULSe:MVIew:RESult:DCYClE(?)

Determines whether to show duty cycle measurement results in the pulse result table.

Syntax :DISPlay:PULSe:MVIew:RESult:DCYClE { 0 | 1 | OFF | ON }
:DISPlay:PULSe:MVIew:RESult:DCYClE?

Arguments OFF or 0 hides duty cycle measurement results in the pulse result table.
ON or 1 shows duty cycle measurement results in the pulse result table.

Measurement Modes TIMPULSE

Examples :DISPlay:PULSe:MVIew:RESult:DCYClE ON
shows duty cycle measurement results in the pulse result table.

:DISPlay:PULSe:MView:RESult:EBWidth(?)

Determines whether to show EBW (Emission Bandwidth) measurement results in the pulse result table.

Syntax :DISPlay:PULSe:MView:RESult:EBWidth { 0 | 1 | OFF | ON }
 :DISPlay:PULSe:MView:RESult:EBWidth?

Arguments OFF or 0 hides EBW measurement results in the pulse result table.
 ON or 1 shows EBW measurement results in the pulse result table.

Measurement Modes TIMPULSE

Examples :DISPlay:PULSe:MView:RESult:EBWidth ON
 shows EBW measurement results in the pulse result table.

:DISPlay:PULSe:MView:RESult:FREQuency(?)

Determines whether to show frequency deviation measurement results in the pulse result table.

Syntax :DISPlay:PULSe:MView:RESult:FREQuency { 0 | 1 | OFF | ON }
 :DISPlay:PULSe:MView:RESult:FREQuency?

Arguments OFF or 0 hides frequency deviation measurement results in the pulse result table.
 ON or 1 shows frequency deviation measurement results in the pulse result table.

Measurement Modes TIMPULSE

Examples :DISPlay:PULSe:MView:RESult:FREQuency ON
 shows frequency deviation measurement results in the pulse result table.

:DISPlay:PULSe:MVlew:RESult:OBWidth(?)

Determines whether to show OBW (Occupied Bandwidth) measurement results in the pulse result table.

Syntax :DISPlay:PULSe:MVlew:RESult:OBWidth { 0 | 1 | OFF | ON }
:DISPlay:PULSe:MVlew:RESult:OBWidth?

Arguments OFF or 0 hides OBW measurement results in the pulse result table.
ON or 1 shows OBW measurement results in the pulse result table.

Measurement Modes TIMPULSE

Examples :DISPlay:PULSe:MVlew:RESult:OBWidth ON
shows OBW measurement results in the pulse result table.

:DISPlay:PULSe:MVlew:RESult:OORatio(?)

Determines whether to show on/off-ratio measurement results in the pulse result table.

Syntax :DISPlay:PULSe:MVlew:RESult:OORatio { 0 | 1 | OFF | ON }
:DISPlay:PULSe:MVlew:RESult:OORatio?

Arguments OFF or 0 hides on/off-ratio measurement results in the pulse result table.
ON or 1 shows on/off-ratio measurement results in the pulse result table.

Measurement Modes TIMPULSE

Examples :DISPlay:PULSe:MVlew:RESult:OORatio ON
shows on/off-ratio measurement results in the pulse result table.

:DISPlay:PULSe:MView:RESult:PERiod(?)

Determines whether to show pulse repetition interval measurement results in the pulse result table.

Syntax :DISPlay:PULSe:MView:RESult:PERiod { 0 | 1 | OFF | ON }
 :DISPlay:PULSe:MView:RESult:PERiod?

Arguments OFF or 0 hides pulse repetition interval measurement results in the pulse result table.

 ON or 1 shows pulse repetition interval measurement results in the pulse result table.

Measurement Modes TIMPULSE

Examples :DISPlay:PULSe:MView:RESult:PERiod ON
 shows pulse repetition interval measurement results in the pulse result table.

:DISPlay:PULSe:MView:RESult:PHASe(?)

Determines whether to show pulse-pulse phase measurement results in the pulse result table.

Syntax :DISPlay:PULSe:MView:RESult:PHASe { 0 | 1 | OFF | ON }
 :DISPlay:PULSe:MView:RESult:PHASe?

Arguments OFF or 0 hides pulse-pulse phase measurement results in the pulse result table.

 ON or 1 shows pulse-pulse phase measurement results in the pulse result table.

Measurement Modes TIMPULSE

Examples :DISPlay:PULSe:MView:RESult:PHASe ON
 shows pulse-pulse phase measurement results in the pulse result table.

:DISPlay:PULSe:MVIew:RESult:PPOWer(?)

Determines whether to show peak power measurement results in the pulse result table.

Syntax :DISPlay:PULSe:MVIew:RESult:PPOWer { 0 | 1 | OFF | ON }
:DISPlay:PULSe:MVIew:RESult:PPOWer?

Arguments OFF or 0 hides peak power measurement results in the pulse result table.
ON or 1 shows peak power measurement results in the pulse result table.

Measurement Modes TIMPULSE

Examples :DISPlay:PULSe:MVIew:RESult:PPOWer ON
shows peak power measurement results in the pulse result table.

:DISPlay:PULSe:MVIew:RESult:RIPPlE(?)

Determines whether to show pulse ripple measurement results in the pulse result table.

Syntax :DISPlay:PULSe:MVIew:RESult:RIPPlE { 0 | 1 | OFF | ON }
:DISPlay:PULSe:MVIew:RESult:RIPPlE?

Arguments OFF or 0 hides pulse ripple measurement results in the pulse result table.
ON or 1 shows pulse ripple measurement results in the pulse result table.

Measurement Modes TIMPULSE

Examples :DISPlay:PULSe:MVIew:RESult:RIPPlE ON
shows pulse ripple measurement results in the pulse result table.

:DISPlay:PULSe:MView:RESult:WIDTh(?)

Determines whether to show pulse width measurement results in the pulse result table.

Syntax :DISPlay:PULSe:MView:RESult:WIDTh { 0 | 1 | OFF | ON }
 :DISPlay:PULSe:MView:RESult:WIDTh?

Arguments OFF or 0 hides peak power measurement results in the pulse result table.
 ON or 1 shows peak power measurement results in the pulse result table.

Measurement Modes TIMPULSE

Examples :DISPlay:PULSe:MView:RESult:WIDTh ON
 shows peak power measurement results in the pulse result table.

:DISPlay:PULSe:SVIew:FORMat(?)

Selects or queries the display format of the subview in the pulse characteristics analysis.

Syntax :DISPlay:PULSe:SVIew:FORMat { WIDTH | PPOWer | OORatio | RIPPlE
| PERIiod | DCYClE | PHASe | CHPower | OBWidth | EBWidth
| FREQuency }

:DISPlay:PULSe:SVIew:FORMat?

Arguments The arguments and display formats are listed below:

Table 2-38: Subview display format

Argument	Display format
WIDTH	Pulse width
PPOWer	Peak power in the pulse-on time
OORatio	Difference between the on-time power and off-time power
RIPPlE	Difference between the maximum and minimum power in the pulse-on time
PERIiod	Time between a pulse rising edge and the next pulse rising edge
DCYClE	Ratio of the pulse width to the pulse repetition interval (PRI)
PHASe	Phase at a certain point in each pulse
CHPower	Channel power of the pulse-on time spectrum
OBWidth	OBW of the pulse-on time spectrum
EBWidth	EBW of the pulse-on time spectrum
FREQuency	Frequency deviation of the pulse-on time

Measurement Modes TIMPULSE

Examples :DISPlay:PULSe:SVIew:FORMat WIDTH
displays the pulse width measurement result and waveform in the subview.

:DISPlay:PULSe:SVIew:GUIDelines(?)

Determines whether to show the guidelines in the subview.

Syntax :DISPlay:PULSe:SVIew:GUIDelines { 0 | 1 | OFF | ON }
 :DISPlay:PULSe:SVIew:GUIDelines?

Arguments OFF or 0 hides the guidelines in the subview.
 ON or 1 shows the guidelines in the subview (default).

Measurement Modes TIMPULSE

Examples :DISPlay:PULSe:SVIew:GUIDelines ON
 shows the guidelines in the subview.

:DISPlay:PULSe:SVIew:RANGe(?)

Selects or queries how to set the horizontal scale in the subview.

Syntax :DISPlay:PULSe:SVIew:RANGe { ADAPtive | MAXimum }
 :DISPlay:PULSe:SVIew:RANGe?

Arguments ADAPtive adjusts the horizontal scale for each pulse to fit the pulse width to the subview (default).
 MAXimum adjusts the horizontal scale to fit the maximum pulse width in the analysis range to the subview.

Measurement Modes TIMPULSE

Examples :DISPlay:PULSe:SVIew:RANGe ADAPtive
 adjusts the horizontal scale for each pulse to fit the pulse width to the subview.

:DISPlay:PULSe:SVIew:RESult(?)

Selects or queries how to show the result graph in the subview.

Syntax :DISPlay:PULSe:SVIew:RESult { SINGle | ALL }
:DISPlay:PULSe:SVIew:RESult?

Arguments SINGle shows the measurement result and waveform for a pulse in the subview. Select the pulse using the :DISPlay:PULSe:SVIew:SElect command.

ALL shows the measurement results for all pulses in the subview, representing pulse numbers along the horizontal axis and measurement values along the vertical axis.

Measurement Modes TIMPULSE

Examples :DISPlay:PULSe:SVIew:RESult SINGle
shows the measurement result and waveform for a pulse in the subview.

Related Commands :DISPlay:PULSe:SVIew:SElect

:DISPlay:PULSe:SVIew:SElect(?)

Selects or queries a pulse to measure when you select SINGle with the :DISPlay:PULSe:SVIew:RESult command.

Syntax :DISPlay:PULSe:SVIew:SElect <number>
:DISPlay:PULSe:SVIew:SElect?

Arguments <number>::=<NR1> specifies the a single pulse number. 0 (zero) represents the latest pulse. The older pulse has the larger negative number. Range: -999 to 0

Measurement Modes TIMPULSE

Examples :DISPlay:PULSe:SVIew:RESult -125
specifies pulse #-125 to display in the subview.

:DISPlay:PULSe:SPECtrum Subgroup

The :DISPlay:PULSe:SPECtrum commands control the spectrum display in the frequency domain measurements under the pulse characteristics analysis.

These commands are valid when you select one of the following items using the :DISPlay:PULSe:SVIEW:FORMat command.

- CHPower (channel power)
- OBWidth (OBW)
- EBWidth (EBW)

NOTE. To use a command from this group, you must have selected TIMPULSE (pulse characteristics analysis) in the :INSTrument[:SElect] command.

Command Tree	Header	Parameter
	:DISPlay	
	:PULSe	
	:SPECtrum	
	:X	
	[:SCALE]	
	:OFFSet	<numeric_value>
	:PDIVision	<numeric_value>
	:Y	
	[:SCALE]	
	:FIT	
	:FULL	
	:OFFSet	<numeric_value>
	:PDIVision	<numeric_value>

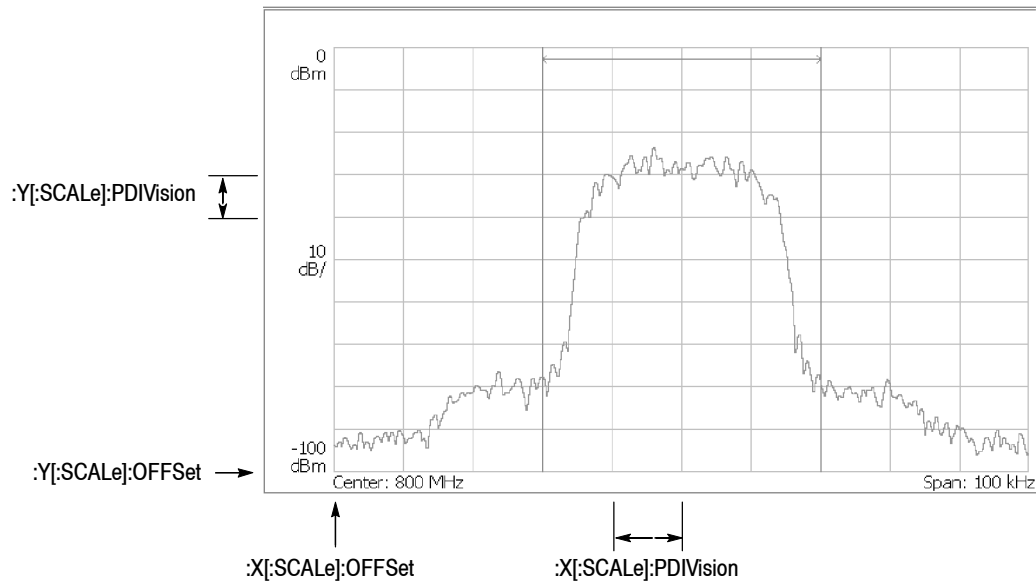

NOTE: Command header :DISPlay:PULSe:SPECTrum is omitted here.

Figure 2-10: :DISPlay:PULSe:SPECTrum command setting

:DISPlay:PULSe:SPECTrum:X[:SCALe]:OFFSet(?)

Sets or queries the minimum horizontal, or frequency, value (left edge) in the spectrum view.

Syntax :DISPlay:PULSe:SPECTrum:X[:SCALe]:OFFSet <freq>
 :DISPlay:PULSe:SPECTrum:X[:SCALe]:OFFSet?

Arguments <freq>::=<NRf> specifies the minimum horizontal value in the spectrum view. For the setting range, refer to *Note on Horizontal Scaling* on page 2-184.

Measurement Modes TIMPULSE

Examples :DISPlay:PULSe:SPECTrum:X:SCALe:OFFSet 100MHz
 sets the minimum horizontal value to 100 MHz.

:DISPlay:PULSe:SPECTrum:X[:SCALe]:PDIVision(?)

Sets or queries the horizontal, or frequency, scale (per division) in the spectrum view.

Syntax :DISPlay:PULSe:SPECTrum:X[:SCALe]:PDIVision <freq>
 :DISPlay:PULSe:SPECTrum:X[:SCALe]:PDIVision?

Arguments <freq>::=<NRf> specifies the horizontal scale. For the setting range, refer to *Note on Horizontal Scaling* on page 2-184.

Measurement Modes TIMPULSE

Examples :DISPlay:PULSe:SPECTrum:X:SCALe:PDIVision 100.0E+3
 sets the horizontal scale to 100 kHz/div.

:DISPlay:PULSe:SPECTrum:Y[:SCALe]:FIT (No Query Form)

Runs the auto-scale on the spectrum view. The auto-scale automatically sets the start value and scale of the vertical axis to fit the waveform to the screen.

Syntax :DISPlay:PULSe:SPECTrum:Y[:SCALe]:FIT

Arguments None

Measurement Modes TIMPULSE

Examples :DISPlay:PULSe:SPECTrum:Y:SCALe:FIT
runs the auto-scale on the spectrum view.

:DISPlay:PULSe:SPECTrum:Y[:SCALe]:FULL (No Query Form)

Sets the vertical axis to the default full-scale value in the spectrum view.

Syntax :DISPlay:PULSe:SPECTrum:Y[:SCALe]:FULL

Arguments None

Measurement Modes TIMPULSE

Examples :DISPlay:PULSe:SPECTrum:Y:SCALe:FULL
sets the vertical axis to the default full-scale value in the spectrum view.

:DISPlay:PULSe:SPECTrum:Y[:SCALe]:OFFSet(?)

Sets or queries the minimum vertical, or amplitude, value (bottom) in the spectrum view.

Syntax :DISPlay:PULSe:SPECTrum:Y[:SCALe]:OFFSet <amp1>
 :DISPlay:PULSe:SPECTrum:Y[:SCALe]:OFFSet?

Arguments <amp1>: :=<NRf> sets the minimum vertical value. Range: -200 to 0 dBm.

Measurement Modes TIMPULSE

Examples :DISPlay:PULSe:SPECTrum:Y:SCALe:OFFSet -100
 sets the minimum vertical value to -100 dBm.

:DISPlay:PULSe:SPECTrum:Y[:SCALe]:PDIVision(?)

Sets or queries the vertical, or amplitude, scale (per division) in the spectrum view.

Syntax :DISPlay:PULSe:SPECTrum:Y[:SCALe]:PDIVision <amp1>
 :DISPlay:PULSe:SPECTrum:Y[:SCALe]:PDIVision?

Arguments <amp1>: :=<NRf> specifies the vertical scale in the spectrum view.
 Range: 0 to 10 dB/div.

Measurement Modes TIMPULSE

Examples :DISPlay:PULSe:SPECTrum:Y:SCALe:PDIVision 10
 sets the vertical scale to 10 dB/div.

:DISPlay:PULSe:WAVEform Subgroup

The :DISPlay:PULSe:WAVEform commands control the time domain display in the time domain measurements under the pulse characteristics analysis.

These commands are valid when you select one of the following items using the :DISPlay:PULSe:SVIEW:FORMat command.

- WIDTH (pulse width)
- PPOWer (peak power)
- OORatio (pulse on/off ratio)
- RIPPlE (pulse ripple)
- PERiod (pulse period)
- DCYCLe (duty cycle)
- PHASe (pulse-pulse phase)
- FREQuency (frequency deviation)

NOTE. To use a command from this group, you must have selected *TIMPULSE* (pulse characteristics analysis) in the :INSTrument[:SElect] command.

Command Tree	Header	Parameter
	:DISPlay	
	:PULSe	
	:WAVEform	
	:X	
	[:SCALe]	
	:OFFSet	<numeric_value>
	:PDIVision	<numeric_value>
	:Y	
	[:SCALe]	
	:FIT	
	:FULL	
	:OFFSet	<numeric_value>
	:PDIVision	<numeric_value>

:DISPlay:PULSe:WAVeform:X[:SCALe]:OFFSet(?)

Sets or queries the minimum value of the horizontal axis (left edge) in the time domain display.

Syntax :DISPlay:PULSe:WAVeform:X[:SCALe]:OFFSet <time>

 :DISPlay:PULSe:WAVeform:X[:SCALe]:OFFSet?

Arguments <time>::=<Nrf> sets the minimum horizontal value. Range: -32000 to 0 s.
For the setting range, refer to *Note on Horizontal Scaling* on page 2-184.

Measurement Modes TIMPULSE

Examples :DISPlay:PULSe:WAVeform:X:SCALe:OFFSet -100us
sets the minimum horizontal value to -100 μ s.

:DISPlay:PULSe:WAVeform:X[:SCALe]:PDIVision(?)

Sets or queries the horizontal, or time, scale (per division) in the time domain display.

Syntax :DISPlay:PULSe:WAVeform:X[:SCALe]:PDIVision <time>

 :DISPlay:PULSe:WAVeform:X[:SCALe]:PDIVision?

Arguments <time>::=<Nrf> specifies the horizontal scale. Range: 0 to 3200 s/div.
For the setting range, refer to *Note on Horizontal Scaling* on page 2-184.

Measurement Modes TIMPULSE

Examples :DISPlay:PULSe:WAVeform:X:SCALe:PDIVision 10us
sets the horizontal scale to 10 μ s/div.

:DISPlay:PULSe:WAVeform:Y[:SCALe]:FIT (No Query Form)

Runs the auto-scale on the time domain display. The auto-scale automatically sets the start value and scale of the vertical axis to fit the waveform to the screen.

Syntax :DISPlay:PULSe:WAVeform:Y[:SCALe]:FIT

Arguments None

Measurement Modes TIMPULSE

Examples :DISPlay:PULSe:WAVeform:Y:SCALe:FIT
runs the auto-scale.

:DISPlay:PULSe:WAVeform:Y[:SCALe]:FULL (No Query Form)

Sets the vertical axis in the time domain display to the default full-scale value.

Syntax :DISPlay:PULSe:WAVeform:Y[:SCALe]:FULL

Arguments None

Measurement Modes TIMPULSE

Examples :DISPlay:PULSe:WAVeform:Y:SCALe:FULL
sets the vertical axis in the time domain display to the default full-scale value.

:DISPlay:PULSe:WAVeform:Y[:SCALe]:OFFSet(?)

Sets or queries the minimum value (bottom) of the vertical axis in the time domain display.

Syntax :DISPlay:PULSe:WAVeform:Y[:SCALe]:OFFSet <amp1>
 :DISPlay:PULSe:WAVeform:Y[:SCALe]:OFFSet?

Arguments <amp1>::=<NRf> specifies the minimum value of the vertical axis. The valid range depends on the display format. Refer to Table D-1 in *Appendix D*.

Measurement Modes TIMPULSE

Examples :DISPlay:PULSe:WAVeform:Y:SCALe:OFFSet -100
 sets the minimum vertical value to -100 dBm.

:DISPlay:PULSe:WAVeform:Y[:SCALe]:PDIVision(?)

Sets the vertical axis scale (per division) in the time domain display.

Syntax :DISPlay:PULSe:WAVeform:Y[:SCALe]:PDIVision <amp1>
 :DISPlay:PULSe:WAVeform:Y[:SCALe]:PDIVision?

Arguments <amp1>::=<NRf> specifies the vertical scale. The valid range depends on the display format. Refer to Table D-1 in *Appendix D*.

Measurement Modes TIMPULSE

Examples :DISPlay:PULSe:WAVeform:Y:SCALe:PDIVision 10
 sets the vertical scale to 10 dB/div

:DISPlay:SPECTrum Subgroup

The :DISPlay:SPECTrum commands control the spectrum view.

NOTE. To use a command from this group, you must have a spectrum that is currently displayed in the view, regardless of the measurement mode.

The :DISPlay:SPECTrum:MLINE (multi display lines) commands are available only in the SARTIME (Real Time S/A) mode.

Command Tree	Header	Parameter
	:DISPlay	
	:SPECTrum	
	:BMARker	
	:STATe	<boolean>
	:GRATicule	
	:GRID	OFF FIX FLEX
	:MLINe	
	:AMPLitude	
	:INTerval	<numeric_value>
	:OFFSet	<numeric_value>
	[:STATe]	<boolean>
	:ANNOtation	
	[:STATe]	<boolean>
	:FREQUency	
	:INTerval	<numeric_value>
	:OFFSet	<numeric_value>
	[:STATe]	<boolean>
	:X	
	[:SCALE]	
	:OFFSet	<frequency>
	:PDIVision	<frequency>
	:Y	
	[:SCALE]	
	:FIT	
	:FULL	
	:OFFSet	<amplitude>
	:PDIVision	<amplitude>

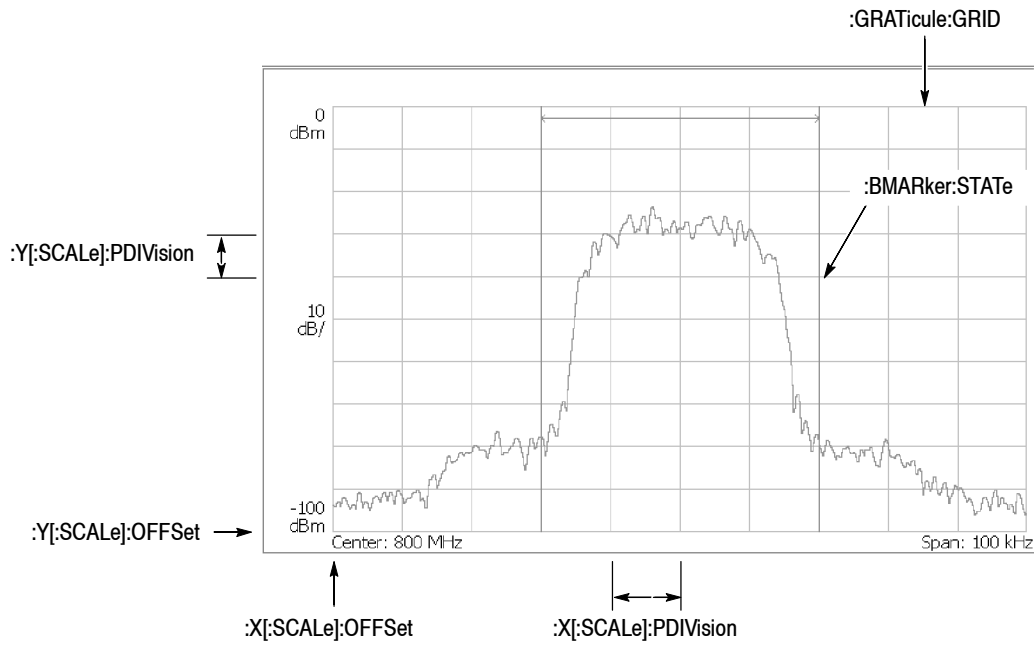

NOTE: Command header `:DISPlay:SPECTrum` is omitted here.

Figure 2- 11: :DISPlay:SPECTrum command setting

:DISPlay:SPECTrum:BMARker:STATe(?)

Determines whether to show the band power marker.

Syntax :DISPlay:SPECTrum:BMARker:STATe { OFF | ON | 0 | 1 }
:DISPlay:SPECTrum:BMARker:STATe?

Arguments OFF or 0 hides the band power marker.
ON or 1 shows the band power marker.

Measurement Modes All

Examples :DISPlay:SPECTrum:BMARker:STATe ON
shows the band power marker.

:DISPlay:SPECTrum:GRATicule:GRID(?)

Selects or queries how the graticule is displayed.

NOTE. This command is available in the S/A (spectrum analysis) mode except Real Time S/A.

Syntax :DISPlay:SPECTrum:GRATicule:GRID { OFF | FIX | FLEX }
:DISPlay:SPECTrum:GRATicule:GRID?

Arguments OFF hides the graticule.
FIX always shows the 10 divisions × 10 divisions graticule.
FLEX shows the graticule so that one division is set in 1-2-5 sequence.

Measurement Modes All S/A modes except SARTIME and SAZRTIME

Examples :DISPlay:SPECTrum:GRATicule:GRID FIX
always shows the 10 × 10 graticule.

:DISPlay:SPECTrum:MLINE:AMPLitude:INTerval(?)

Sets or queries the interval of the amplitude multi display lines in the spectrum view.

Syntax :DISPlay:SPECTrum:MLINE:AMPLitude:INTerval <value>
 :DISPlay:SPECTrum:MLINE:AMPLitude:INTerval?

Arguments <value>::=<NRf> sets the interval of the amplitude multi display lines.
Range: 0 to 100 dB.

Measurement Modes SARTIME

Examples :DISPlay:SPECTrum:MLINE:AMPLitude:INTerval 5
sets the interval to 5 dB.

:DISPlay:SPECTrum:MLINE:AMPLitude:OFFSet(?)

Sets or queries the offset of the amplitude multi display lines in the spectrum view.

Syntax :DISPlay:SPECTrum:MLINE:AMPLitude:OFFSet <value>
 :DISPlay:SPECTrum:MLINE:AMPLitude:OFFSet?

Arguments <value>::=<NRf> sets the offset of the amplitude multi display lines.
Range: -100 to 0 dBm.

Measurement Modes SARTIME

Examples :DISPlay:SPECTrum:MLINE:AMPLitude:OFFSet -10
sets the offset to -10 dBm.

:DISPlay:SPECTrum:MLINE:AMPLitude[:STATe](?)

Determines whether to show the amplitude multi display lines in the spectrum view.

Syntax :DISPlay:SPECTrum:MLINE:AMPLitude[:STATe] { OFF | ON | 0 | 1 }
:DISPlay:SPECTrum:MLINE:AMPLitude[:STATe]?

Arguments OFF or 0 hides the amplitude multi display lines.
ON or 1 shows the amplitude multi display lines.

Measurement Modes SARTIME

Examples :DISPlay:SPECTrum:MLINE:AMPLitude:STATe ON
shows the amplitude multi display lines.

:DISPlay:SPECTrum:MLINE:ANNotation[:STATe](?)

Determines whether to show the multi display lines readout in the spectrum view.

Syntax :DISPlay:SPECTrum:MLINE:ANNotation[:STATe] { OFF | ON | 0 | 1 }
:DISPlay:SPECTrum:MLINE:ANNotation[:STATe]?

Arguments OFF or 0 hides the multi display lines readout.
ON or 1 shows the multi display lines readout.

Measurement Modes SARTIME

Examples :DISPlay:SPECTrum:MLINE:ANNotation:STATe ON
shows the readout.

:DISPlay:SPECTrum:MLINE:FREQuency:INTerval(?)

Sets or queries the interval of the frequency multi display lines in the spectrum view.

Syntax :DISPlay:SPECTrum:MLINE:FREQuency:INTerval <value>
 :DISPlay:SPECTrum:MLINE:FREQuency:INTerval?

Arguments <value>::=<NRf> sets the interval of the frequency multi display lines.
 Range: 0 to full span (Hz).

Measurement Modes SARTIME

Examples :DISPlay:SPECTrum:MLINE:FREQuency:INTerval 1MHz
 sets the interval to 1 MHz.

:DISPlay:SPECTrum:MLINE:FREQuency:OFFSet(?)

Sets or queries the offset of the frequency multi display lines in the spectrum view.

Syntax :DISPlay:SPECTrum:MLINE:FREQuency:OFFSet <value>
 :DISPlay:SPECTrum:MLINE:FREQuency:OFFSet?

Arguments <value>::=<NRf> sets the offset of the frequency multi display lines.
 Range: Center frequency \pm Span/2 (Hz)

The default value is the center frequency; the frequency multi display lines are placed from the center frequency at regular intervals.

Measurement Modes SARTIME

Examples :DISPlay:SPECTrum:MLINE:FREQuency:OFFSet 2GHz
 sets the offset to 2 GHz.

:DISPlay:SPECTrum:MLINe:FREQuency[:STATe](?)

Determines whether to show the frequency multi display lines in the spectrum view.

Syntax :DISPlay:SPECTrum:MLINe:FREQuency[:STATe] { OFF | ON | 0 | 1 }
 :DISPlay:SPECTrum:MLINe:FREQuency[:STATe]?

Arguments OFF or 0 hides the frequency multi display lines.
 ON or 1 shows the frequency multi display lines.

Measurement Modes SARTIME

Examples :DISPlay:SPECTrum:MLINe:FREQuency:STATe ON
 shows the frequency multi display lines.

:DISPlay:SPECTrum:X[:SCALe]:OFFSet(?)

Sets or queries the minimum horizontal, or frequency, value (left edge) in the spectrum view.

Syntax :DISPlay:SPECTrum:X[:SCALe]:OFFSet <freq>
 :DISPlay:SPECTrum:X[:SCALe]:OFFSet?

Arguments <freq>::=<NRf> specifies the minimum horizontal value in the spectrum view. Refer to *Note on Horizontal Scaling* on page 2-184 for setting the scale.

Measurement Modes All

Examples :DISPlay:SPECTrum:X:SCALe:OFFSet 100MHz
 sets the minimum horizontal value to 100 MHz.

:DISPlay:SPECTrum:X[:SCALe]:PDIVision(?)

Sets or queries the horizontal, or frequency, scale (per division) in the spectrum view.

Syntax :DISPlay:SPECTrum:X[:SCALe]:PDIVision <freq>
 :DISPlay:SPECTrum:X[:SCALe]:PDIVision?

Arguments <freq>::=<NRf> specifies the horizontal scale. Refer to *Note on Horizontal Scaling* on page 2-184 for setting the scale.

Measurement Modes All

Examples :DISPlay:SPECTrum:X:SCALe:PDIVision 100.0E+3
 sets the horizontal scale to 100 kHz/div.

:DISPlay:SPECTrum:Y[:SCALE]:FIT (No Query Form)

Runs the auto-scale on the spectrum view. The auto-scale automatically sets the start value and scale of the vertical axis to display the whole waveform.

Syntax :DISPlay:SPECTrum:Y[:SCALE]:FIT

Arguments None

Measurement Modes All

Examples :DISPlay:SPECTrum:Y:SCALE:FIT
runs the auto-scale on the spectrum view.

:DISPlay:SPECTrum:Y[:SCALE]:FULL (No Query Form)

Sets the vertical axis to the default full-scale value in the spectrum view.

Syntax :DISPlay:SPECTrum:Y[:SCALE]:FULL

Arguments None

Measurement Modes All

Examples :DISPlay:SPECTrum:Y:SCALE:FULL
sets the vertical axis to the default full-scale value in the spectrum view.

:DISPlay:SPECTrum:Y[:SCALe]:OFFSet(?)

Sets or queries the minimum vertical, or amplitude, value (bottom) in the spectrum view.

Syntax :DISPlay:SPECTrum:Y[:SCALe]:OFFSet <amp1>
 :DISPlay:SPECTrum:Y[:SCALe]:OFFSet?

Arguments <amp1>::=<NRf> sets the minimum vertical value. Range: -200 to 0 dBm.

Measurement Modes All

Examples :DISPlay:SPECTrum:Y:SCALe:OFFSet -100
 sets the minimum vertical value to -100 dBm.

:DISPlay:SPECTrum:Y[:SCALe]:PDIVision(?)

Sets or queries the vertical, or amplitude, scale (per division) in the spectrum view.

Syntax :DISPlay:SPECTrum:Y[:SCALe]:PDIVision <amp1>
 :DISPlay:SPECTrum:Y[:SCALe]:PDIVision?

Arguments <amp1>::=<NRf> specifies the horizontal scale in the spectrum view.
 Range: 0 to 10 dB/div.

Measurement Modes All

Examples :DISPlay:SPECTrum:Y:SCALe:PDIVision 10
 sets the vertical scale to 10 dB/div.

:DISPlay:TFRequency Subgroup

The :DISPlay:TFRequency commands control a three-dimensional view (spectrogram).

NOTE. To use a command from this group, you must have selected SARTIME (Real Time S/A) in the :INSTRument[:SElect] command.

In the SASGRAM (S/A with Spectrogram) mode, you cannot set the scale of the spectrogram.

Command Tree	Header	Parameter
	:DISPlay	
	:TFRequency	
	:SGRam	
	:COLor	
	[:SCALE]	
	:OFFSet	<amplitude>
	:RANge	<relative_amplitude>
	:MLINe	
	:ANNotation	
	[:STATe]	<boolean>
	:FREQUency	
	:INTerval	<numeric_value>
	:OFFSet	<numeric_value>
	[:STATe]	<boolean>
	:TIME	
	:INTerval	<numeric_value>
	:OFFSet	<numeric_value>
	[:STATe]	<boolean>
	:X	
	[:SCALE]	
	:OFFSet	<frequency>
	:SPAN	<frequency>
	:Y	
	[:SCALE]	
	:OFFSet	<frame_count>
	:PLINe	<frame_count>

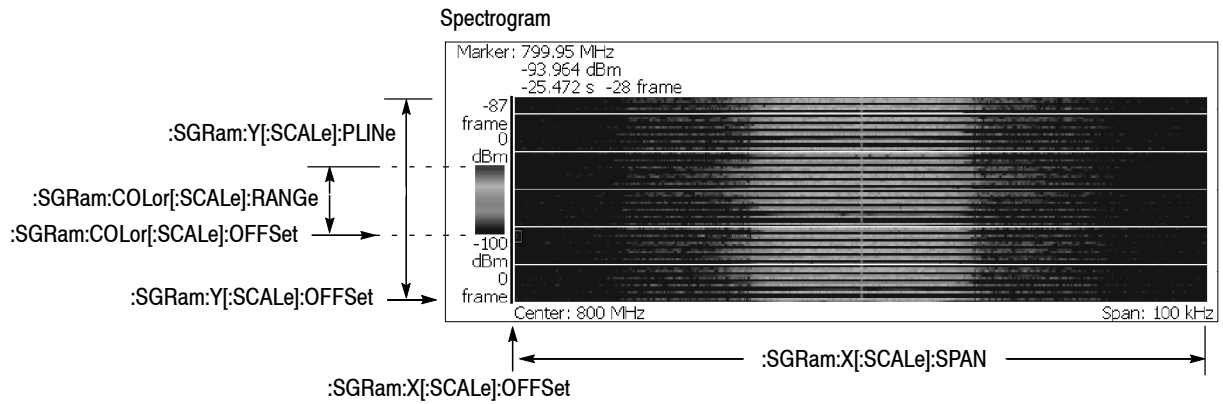

NOTE: Command header :DISPlay:TFrequency is omitted here.

Figure 2- 12: :DISPlay:TFrequency command setting

:DISPlay:TFRequency:SGRam:COLor[:SCALe]:OFFSet(?)

Sets or queries the minimum value (bottom) of the color, or amplitude, axis in the spectrogram.

Syntax :DISPlay:TFRequency:SGRam:COLor[:SCALe]:OFFSet <amp1>

:DISPlay:TFRequency:SGRam:COLor[:SCALe]:OFFSet?

Arguments <amp1>: :=<NRf> specifies the minimum color-axis value.
Range: -200 to 0 dBm.

Measurement Modes SARTIME

Examples :DISPlay:TFRequency:SGRam:COLor:SCALe:OFFSet -100
sets the minimum color-axis value to -100 dBm.

:DISPlay:TFRequency:SGRam:COLor[:SCALe]:RANGe(?)

Sets or queries full-scale value of the color, or amplitude, axis in the spectrogram.

Syntax :DISPlay:TFRequency:SGRam:COLor[:SCALe]:RANGe <rel_amp1>

:DISPlay:TFRequency:SGRam:COLor[:SCALe]:RANGe?

Arguments <rel_amp1>: :={ 10 | 20 | 50 | 100 } [dB] specifies full-scale value of the color axis.

Measurement Modes SARTIME

Examples :DISPlay:TFRequency:SGRam:COLor:SCALe:RANGe 100
sets full-scale value of the color axis to 100 dB.

:DISPlay:TFRequency:SGRam:MLINe:ANNotation[:STATe](?)

Determines whether to show the multi display lines readout in the spectrogram.

Syntax :DISPlay:TFRequency:SGRam:MLINe:ANNotation[:STATe] { OFF | ON
 | 0 | 1 }

:DISPlay:TFRequency:SGRam:MLINe:ANNotation[:STATe]?

Arguments OFF or 0 hides the multi display lines readout.

ON or 1 shows the multi display lines readout.

Measurement Modes SARTIME

Examples :DISPlay:TFRequency:SGRam:MLINe:ANNotation:STATe ON
 shows the readout.

:DISPlay:TFRequency:SGRam:MLINe:FREQuency:INTerval(?)

Sets or queries the interval of the frequency multi display lines in the spectrogram.

Syntax :DISPlay:TFRequency:SGRam:MLINe:FREQuency:INTerval <value>

:DISPlay:TFRequency:SGRam:MLINe:FREQuency:INTerval?

Arguments <value>::=<NRf> sets the interval of the frequency multi display lines.
Range: 0 to full span (Hz).

Measurement Modes SARTIME

Examples :DISPlay:TFRequency:SGRam:MLINe:FREQuency:INTerval 1MHz
 sets the interval to 1 MHz.

:DISPlay:TFREquency:SGRam:MLINe:FREQuency:OFFSet(?)

Sets or queries the offset of the frequency multi display lines in the spectrogram.

Syntax :DISPlay:TFREquency:SGRam:MLINe:FREQuency:OFFSet <value>
:DISPlay:TFREquency:SGRam:MLINe:FREQuency:OFFSet?

Arguments <value>::=<Nrf> sets the offset of the frequency multi display lines.
Range: Center frequency \pm Span/2 (Hz)

The default value is the center frequency; the frequency multi display lines are placed from the center frequency at regular intervals.

Measurement Modes SARTIME

Examples :DISPlay:TFREquency:SGRam:MLINe:FREQuency:OFFSet 2GHz
sets the offset to 2 GHz.

:DISPlay:TFREquency:SGRam:MLINe:FREQuency[:STATe](?)

Determines whether to show the frequency multi display lines in the spectrogram.

Syntax :DISPlay:TFREquency:SGRam:MLINe:FREQuency[:STATe] { OFF | ON
| 0 | 1 }
:DISPlay:TFREquency:SGRam:MLINe:FREQuency[:STATe]?

Arguments OFF or 0 hides the frequency multi display lines.
ON or 1 shows the frequency multi display lines.

Measurement Modes SARTIME

Examples :DISPlay:TFREquency:SGRam:MLINe:FREQuency:STATe ON
shows the frequency multi display lines.

:DISPlay:TFRequency:SGRam:MLINe:TIME:INTerval(?)

Sets or queries the interval of the time multi display lines in the spectrogram.

Syntax :DISPlay:TFRequency:SGRam:MLINe:TIME:INTerval <value>
 :DISPlay:TFRequency:SGRam:MLINe:TIME:INTerval?

Arguments <value>::=<NRf> sets the interval of the time multi display lines.
 Range: 0 second minimum.
 The maximum value depends on acquired data quantity.

Measurement Modes SARTIME

Examples :DISPlay:TFRequency:SGRam:MLINe:TIME:INTerval 1m
 sets the interval to 1 ms.

:DISPlay:TFRequency:SGRam:MLINe:TIME:OFFSet(?)

Sets or queries the offset of the time multi display lines in the spectrogram.

Syntax :DISPlay:TFRequency:SGRam:MLINe:TIME:OFFSet <value>
 :DISPlay:TFRequency:SGRam:MLINe:TIME:OFFSet?

Arguments <value>::=<NRf> sets the offset of the time multi display lines.
 Range: 0 second maximum (Zero represents the latest frame.)
 The minimum value depends on acquired data quantity.

Measurement Modes SARTIME

Examples :DISPlay:TFRequency:SGRam:MLINe:TIME:OFFSet -500u
 sets the offset to -500 μ s.

:DISPlay:TFRequency:SGRam:MLINe:TIME[:STATe](?)

Determines whether to show the time multi display lines in the spectrogram.

Syntax :DISPlay:TFRequency:SGRam:MLINe:TIME[:STATe] { OFF | ON | 0 | 1 }
:DISPlay:TFRequency:SGRam:MLINe:TIME[:STATe]?

Arguments OFF or 0 hides the time multi display lines.
ON or 1 shows the time multi display lines.

Measurement Modes SARTIME

Examples :DISPlay:TFRequency:SGRam:MLINe:TIME:STATe ON
shows the time multi display lines.

:DISPlay:TFRequency:SGRam:X[:SCALe]:OFFSet(?)

Sets or queries the minimum horizontal, or frequency, value (left edge) in the spectrogram.

Syntax :DISPlay:TFRequency:SGRam:X[:SCALe]:OFFSet <freq>

:DISPlay:TFRequency:SGRam:X[:SCALe]:OFFSet?

Arguments <freq>::=<NRf> specifies the minimum horizontal value in the spectrogram. Refer to *Note on Horizontal Scaling* on page 2-184 for setting the scale.

Measurement Modes SARTIME

Examples :DISPlay:TFRequency:SGRam:X:SCALe:OFFSet 100MHz
sets the minimum horizontal value to 100 MHz.

:DISPlay:TFRequency:SGRam:X[:SCALe]:SPAN(?)

Sets or queries the horizontal, or frequency, span in the spectrogram.

Syntax :DISPlay:TFRequency:SGRam:X[:SCALe]:SPAN <freq>

:DISPlay:TFRequency:SGRam:X[:SCALe]:SPAN?

Arguments <freq>::=<NRf> specifies the horizontal span in the spectrogram. Refer to *Note on Horizontal Scaling* on page 2-184 for setting the scale.

Measurement Modes SARTIME

Examples :DISPlay:TFRequency:SGRam:X:SCALe:SPAN 10MHz
sets the span to 10 MHz.

:DISPlay:TFrequency:SGRam:Y[:SCALe]:OFFSet(?)

Sets or queries the minimum horizontal, or frame number, value (bottom) in the spectrogram.

Syntax :DISPlay:TFrequency:SGRam:Y[:SCALe]:OFFSet <value>

:DISPlay:TFrequency:SGRam:Y[:SCALe]:OFFSet?

Arguments <value>::=<NR1> specifies the minimum vertical value in the spectrogram.
Range: Frame # -63999 to 0.

Measurement Modes SARTIME

Examples :DISPlay:TFrequency:SGRam:Y:SCALe:OFFSet -100
sets the minimum vertical value to frame # -100.

:DISPlay:TFrequency:SGRam:Y[:SCALe]:PLINe(?)

Sets or queries the vertical scale (the number of frames per line) when the overview displays a spectrogram.

Frames are thinned out from all the acquired framed data at intervals of the number of frames specified in this command, before the spectrogram is displayed. For example, if you set the argument to 5, the data will be displayed every 5 frames.

Syntax :DISPlay:TFrequency:SGRam:Y[:SCALe]:PLINe <value>

:DISPlay:TFrequency:SGRam:Y[:SCALe]:PLINe?

Arguments <value>::=<NR1> specifies the vertical scale in the spectrogram.
Range: 1 to 1024 frames per line.

Measurement Modes SARTIME

Examples :DISPlay:TFrequency:SGRam:Y:SCALe:PLINe 5
displays the data in the spectrogram every 5 frames.

:DISPlay[:VIEW] Subgroup

The :DISPlay[:VIEW] commands control the display brightness and format.

Command Tree	Header	Parameter
	:DISPlay	
	[:VIEW]	
	:BRIGhtness	<numeric_value>
	:FORMat	V1S V3S V4S VSPL HSPL MULTitude

:DISPlay[:VIEW]:BRIGhtness(?)

Sets or queries the display brightness.

Syntax :DISPlay[:VIEW]:BRIGhtness <value>
 :DISPlay[:VIEW]:BRIGhtness?

Arguments <value>::=<NRf> specifies the brightness. Range: 0 to 1.0.
 1.0 represents the maximum brightness.

NOTE. Using the front-panel keys (**SYSTEM** → **Display Brightness**), the brightness range is 0 to 100% (default: 100%).

Measurement Modes All

Examples :DISPlay:VIEW:BRIGhtness 1
 sets the display brightness to 1 (maximum).

:DISPlay[:VIEW]:FORMat(?)

Selects or queries the view display format.

Syntax :DISPlay[:VIEW]:FORMat { V1S | V3S | V4S | VSPL | HSPL
 | MULTitude }
 :DISPlay[:VIEW]:FORMat?

Arguments V1S specifies that only View 1 is displayed.
 V3S specifies that only View 3 is displayed.
 V4S specifies that only View 4 is displayed.
 VSPL specifies that Views 1 and 4 are tiled horizontally.
 HSPL specifies that Views 1 and 4 are tiled vertically.
 MULTitude specifies that multiple views are displayed simultaneously.

NOTE. You must have selected SASGRAM or SARTIME with the INSTRUMENT[:SELEct] command to use VSPL or HSPL.

You must have selected a measurement mode which has three views to use MULTitude.

Measurement Modes All

Examples :DISPlay:VIEW:FORMat V1S
specifies that only View 1 is displayed.

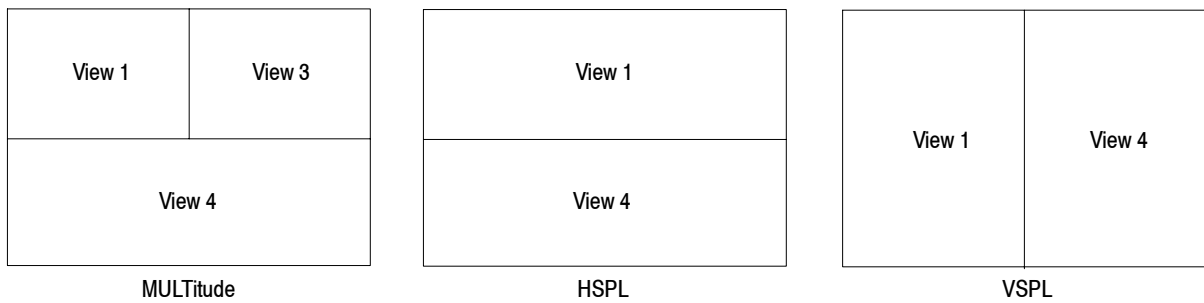

Figure 2- 13: View display formats

Related Commands :INSTRument[:SELEct]

:DISPlay:WAVeform Subgroup

The :DISPlay:WAVeform commands control the time domain display in the main view in the Demod (modulation analysis) and Time (time analysis) modes. There are six types of time domain display associated with six different measurement items:

- Frequency vs. Time
- I/Q level vs. Time
- Frequency shift vs. Time
- AM demodulation display (percentage modulation vs. time)
- FM demodulation display (frequency shift vs. time)
- PM demodulation display (phase shift vs. time)

NOTE. To use a command from this group, you must have selected *DEMADEM* (analog modulation analysis) or *TIMTRAN* (time characteristic analysis) in the :INSTrument[:SELEct] command.

Command Tree	Header	Parameter
	:DISPlay	
	:WAVeform	
	:X	
	[:SCALe]	
	:OFFSet	<time>
	:PDIVision	<time>
	:Y	
	[:SCALe]	
	:FIT	
	:FULL	
	:OFFSet	<amplitude>
	:PDIVision	<amplitude>

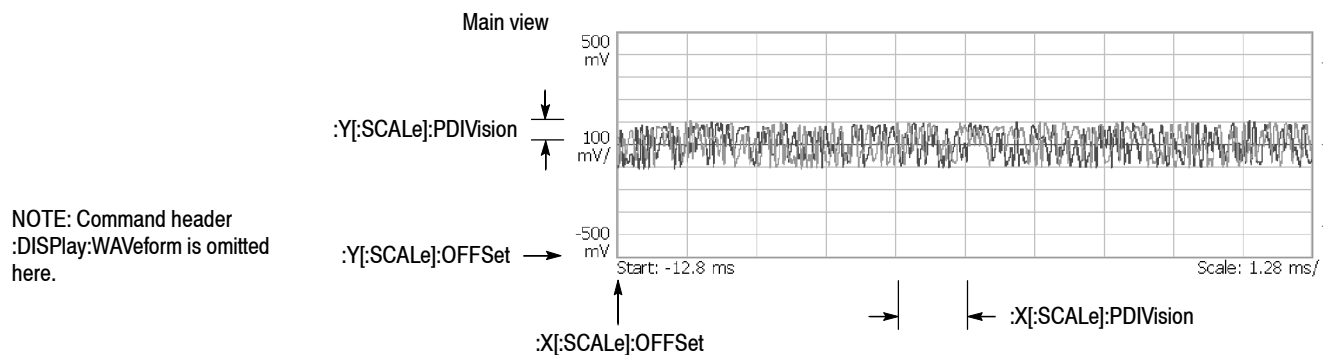

Figure 2-14: :DISPlay:WAVeform command setting

:DISPlay:WAVeform:X[:SCALe]:OFFSet(?)

Sets or queries the minimum value of the horizontal axis (left edge) in the time domain display.

Syntax :DISPlay:WAVeform:X[:SCALe]:OFFSet <time>

:DISPlay:WAVeform:X[:SCALe]:OFFSet?

Arguments <time>::=<NRf> sets the minimum horizontal value. Range: -32000 to 0 s. Refer to *Note on Horizontal Scaling* on page 2-184 for setting the scale.

Measurement Modes DEMADEM, DEMDDEM, TIMTRAN

Examples :DISPlay:WAVeform:X:SCALe:OFFSet -100us
sets the minimum horizontal value to -100 μ s.

:DISPlay:WAVeform:X[:SCALe]:PDIVision(?)

Sets or queries the horizontal, or time, scale (per division) in the time domain display.

Syntax :DISPlay:WAVeform:X[:SCALe]:PDIVision <time>

:DISPlay:WAVeform:X[:SCALe]:PDIVision?

Arguments <time>::=<NRf> specifies the horizontal scale. Range: 0 to 3200 s/div. Refer to *Note on Horizontal Scaling* on page 2-184 for setting the scale.

Measurement Modes DEMADEM, DEMDDEM, TIMTRAN

Examples :DISPlay:WAVeform:X:SCALe:PDIVision 10us
sets the horizontal scale to 10 μ s/div.

:DISPlay:WAVeform:Y[:SCALe]:FIT (No Query Form)

Runs the auto-scale on the time domain display. The auto-scale automatically sets the start value and scale of the vertical axis to display the whole waveform.

Syntax :DISPlay:WAVeform:Y[:SCALe]:FIT

Arguments None

Measurement Modes DEMADEM, DEMDDEM, TIMTRAN

Examples :DISPlay:WAVeform:Y:SCALe:FIT
runs the auto-scale.

:DISPlay:WAVeform:Y[:SCALe]:FULL (No Query Form)

Sets the vertical axis in the time domain display to the default full-scale value.

Syntax :DISPlay:WAVeform:Y[:SCALe]:FULL

Arguments None

Measurement Modes DEMADEM, DEMDDEM, TIMTRAN

Examples :DISPlay:WAVeform:Y:SCALe:FULL
sets the vertical axis in the time domain display to the default full-scale value.

:DISPlay:WAVeform:Y[:SCALe]:OFFSet(?)

Sets or queries the minimum value of the vertical axis (bottom) in the time domain display.

Syntax :DISPlay:WAVeform:Y[:SCALe]:OFFSet <amp1>
 :DISPlay:WAVeform:Y[:SCALe]:OFFSet?

Arguments <amp1>::=<NRf> specifies the minimum value of the vertical axis. The valid range depends on the display format. Refer to Table D-1 in *Appendix D*.

Measurement Modes DEMADEM, DEMDDEM, TIMTRAN

Examples :DISPlay:WAVeform:Y:SCALe:OFFSet -100
 sets the minimum vertical value to -100 dBm.

:DISPlay:WAVeform:Y[:SCALe]:PDIVision(?)

Sets the vertical axis scale (per division) in the time domain display.

Syntax :DISPlay:WAVeform:Y[:SCALe]:PDIVision <amp1>
 :DISPlay:WAVeform:Y[:SCALe]:PDIVision?

Arguments <amp1>::=<NRf> specifies the vertical scale. The valid range depends on the display format. Refer to Table D-1 in *Appendix D*.

Measurement Modes DEMADEM, DEMDDEM, TIMTRAN

Examples :DISPlay:WAVeform:Y:SCALe:PDIVision 10
 sets the vertical scale to 10 dB/div.

:DISPlay Commands (Option)

This section describes the :DISPlay commands for optional analysis software as shown in Table 2-39.

Table 2-39: :DISPlay command subgroups (Option)

Command header	Function	Refer to :
Option 21 Advanced measurement suite related		
:DISPlay:DDEMod	Controls display of the digital modulation analysis.	page 2-251
:DISPlay:RFID:DDEMod	Controls display of the RFID modulation analysis.	page 2-280
:DISPlay:RFID:SPECTrum	Controls the spectrum view in the RFID analysis.	page 2-299
:DISPlay:RFID:WAVEform	Controls the time domain view in the RFID analysis.	page 2-303
:DISPlay:SSOurce:MVlew	Controls the main view display of the signal source analysis.	page 2-307
:DISPlay:SSOurce:SVlew	Controls the subview display of the signal source analysis.	page 2-316
:DISPlay:SSOurce:SPECTrum	Controls the spectrum view in the signal source analysis.	page 2-328
:DISPlay:SSOurce:TFRequency	Controls the three-dimensional view in the signal source analysis.	page 2-332
:DISPlay:SSOurce:WAVEform	Controls the time domain view in the signal source analysis.	page 2-336
Option 23 W-CDMA uplink analysis related		
:DISPlay:AC3Gpp	Controls display of the ACLR analysis in W-CDMA.	page 2-340
:DISPlay:UL3Gpp	Controls display of the uplink analysis in W-CDMA.	page 2-344
Option 24 GSM/EDGE analysis related		
:DISPlay:GSMedge:DDEMod	Controls display of the modulation analysis in GSM/EDGE.	page 2-365
:DISPlay:GSMedge:SPECTrum	Controls the spectrum view in the GSM/EDGE analysis.	page 2-380
:DISPlay:GSMedge:WAVEform	Controls the time domain view in the GSM/EDGE analysis.	page 2-385
Option 25 cdma2000 analysis related		
:DISPlay:FLCDMA2K RLCDMA2K:CCDF	Controls display of the CCDF analysis in cdma2000.	page 2-390
:DISPlay:FLCDMA2K RLCDMA2K:DDEMod	Controls display of the modulation analysis in cdma2000.	page 2-397
:DISPlay:FLCDMA2K RLCDMA2K:SPECTrum	Controls the spectrum view in the cdma2000 analysis.	page 2-409
:DISPlay:RLCDMA2K:WAVEform	Controls the time domain view in the cdma2000 analysis.	page 2-413
Option 26 1xEV-DO analysis related		
:DISPlay:FL1XEVD0 RL1XEVD0:CCDF	Controls display of the CCDF analysis in cdma2000.	page 2-417
:DISPlay:FL1XEVD0 RL1XEVD0:DDEMod	Controls display of the modulation analysis in cdma2000.	page 2-424
:DISPlay:FL1XEVD0 RL1XEVD0:SPECTrum	Controls the spectrum view in the cdma2000 analysis.	page 2-436
:DISPlay:RL1XEVD0:WAVEform	Controls the time domain view in the cdma2000 analysis.	page 2-440

Table 2-39: :DISPlay command subgroups (Option) (Cont.)

Command header	Function	Refer to :
Option 27 3GPP-R5 analysis related		
:DISPlay:DLR5_3GPP	Controls display for the 3GPP-R5 downlink modulation analysis.	page 2-444
:DISPlay:SADLR5_3GPP SAULR5_3GPP	Controls display of the spectrum analysis for 3GPP-R5.	page 2-463
:DISPlay:ULR5_3GPP	Controls display for the 3GPP-R5 uplink modulation analysis.	page 2-467
Option 28 TD-SCDMA analysis related		
:DISPlay:TD_SCDMA:DDEMod	Controls display of the main view and subview.	page 2-482
:DISPlay:TD_SCDMA:SPECtrum	Controls spectrum display in the TD-SCDMA analysis.	page 2-508
Option 29 WLAN analysis related		
:DISPlay:M2WLAN:DDEMod	Controls display in the 802.11n MIMO (2x2) modulation analysis.	page 2-512
:DISPlay:M2WLAN:TFRrequency	Controls the 3-D views in the 802.11n MIMO (2x2) analysis.	page 2-535
:DISPlay:SWLAN:DDEMod	Controls display in the 802.11n (nx1) modulation analysis.	page 2-546
:DISPlay:SWLAN:SPECtrum	Controls the spectrum view in the 802.11n (nx1) analysis.	page 2-574
:DISPlay:SWLAN:TFRrequency	Controls the three-dimensional views in the 802.11n (nx1) analysis.	page 2-578
:DISPlay:WLAN:DDEMod	Controls display in the 802.11a/b/g modulation analysis.	page 2-589
:DISPlay:WLAN:SPECtrum	Controls the spectrum view in the 802.11a/b/g analysis.	page 2-607
Option 40 3GPP-R6 analysis related		
:DISPlay:DLR6_3GPP	Controls display of the modulation analysis for 3GPP-R6 downlink.	page 2-611
:DISPlay:ULR6_3GPP	Controls display of the modulation analysis for 3GPP-R6 uplink.	page 2-633

:DISPlay:DDEMod Subgroup**Modulation Analysis, Option 21 Only**

The :DISPlay:DDEMod commands control display for the digital modulation analysis.

NOTE. To use a command from this group, you must have selected DEMDDEM (digital modulation analysis) in the :INSTrument[:SElect] command.

Command Tree	Header	Parameter
	:DISPlay	
	:DDEMod	
	:CCDF	
	:LINE	
	:GAUSSian	
	[:STATE]	<boolean>
	:MVIew	
	:DStArt	AUTO FIX ADD
	:FORMat	OFF IQVTime FVTime CONSTe VECTor EVM MERRor PERRor IEYE QEYE TEYE STABLe PVTTime AMAM AMPM DAMam DAMPm CCDF PDF
	:HSSHift	LEFT NONE RIGHT
	:RADix	BINary OCTal HEXadecimal
	:X	
	[:SCALE]	
	:OFFSet	<numeric_value>
	:RANGe	<numeric_value>
	:Y	
	[:SCALE]	
	:FIT	
	:FULL	
	:MAXimum	<numeric_value>
	:MINimum	<numeric_value>
	:OFFSet	<numeric_value>
	:RANGe	<numeric_value>
	:NLINearity	
	:LINE	
	:BFIT	
	[:STATE]	<boolean>
	:REFerence	
	[:STATE]	<boolean>
	:MASK	
	[:STATE]	<boolean>

```
:SVIew
:DSStart      AUTO | FIX | ADD
:FORMat       SPECTrum | IQVTime | FVTime
              | CONStE | VECTor | EVM
              | MERRor | PERRor
              | IEYE | QEYE | TEYE | STABle
              | PVTime | AMAM | AMPM
              | DAMam | DAMPm | CCDF | PDF
:HSSHift      LEFT | NONE | RIGHT
:RADix        BINary | OCTal | HEXadecima1
:X
  [:SCALE]
  :OFFSet     <numeric_value>
  :RANGe      <numeric_value>
:Y
  [:SCALE]
  :FIT
  :FULL
  :MAXimum    <numeric_value>
  :MINimum    <numeric_value>
  :OFFSet     <numeric_value>
  :RANGe      <numeric_value>
```

NOTE: Command header :DISPlay:DDEMod is omitted here.

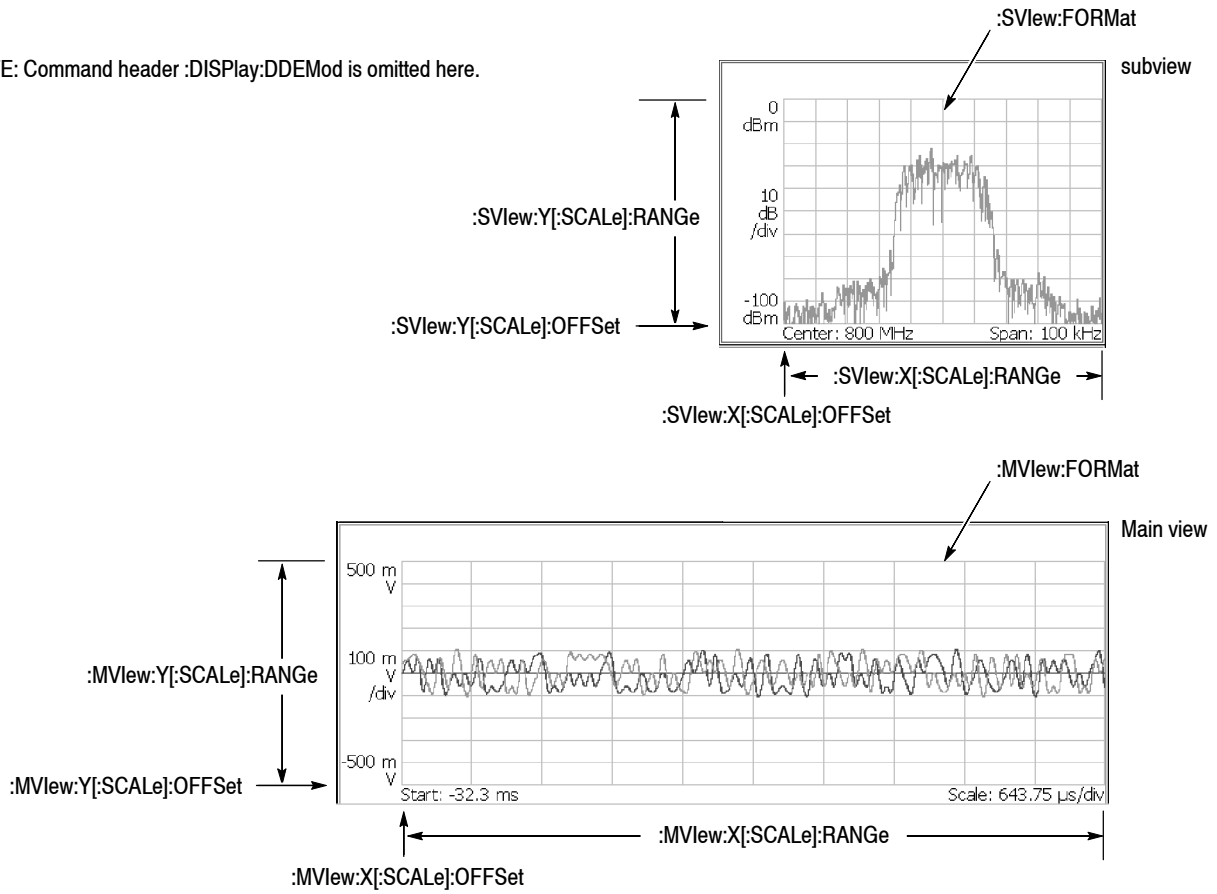

Figure 2- 15: :DISPlay:DDEMod command setting

:DISPlay:DDEMod:CCDF:LINE:GAUSSian[:STATe](?)

Determines whether to display the Gaussian line for CCDF measurement in the digital modulation analysis. This command is valid only when :DISPlay:DDEMod:MView:FORMat is set to CCDF.

Syntax :DISPlay:DDEMod:CCDF:LINE:GAUSSian[:STATe]
 { ON | OFF | 1 | 0 }

 :DISPlay:DDEMod:CCDF:LINE:GAUSSian[:STATe]?

Arguments OFF or 0 shows the Gaussian line.
 ON or 1 hides the Gaussian line.

Measurement Modes DEMDDDEM

Examples :DISPlay:DDEMod:CCDF:LINE:GAUSSian:STATe ON
 displays the Gaussian line for the CCDF measurement.

Related Commands :DISPlay:DDEMod:MView:FORMat

:DISPlay:DDEMod:MView:DStart(?)

Selects or queries the decoding start position for ASK, FSK, and GFSK signals with the decoding format of Manchester or Miller on the main view during the digital modulation analysis.

This command is valid when :DISPlay:DDEMod:MView:FORMat is set to STABLE (symbol table), and [:SENSE]:DDEMod:FORMat is set to ASK, FSK, or GFSK.

Syntax :DISPlay:DDEMod:MView:DStart { AUTO | FIX | ADD }
:DISPlay:DDEMod:MView:DStart?

Arguments AUTO determines the decoding start position automatically.
FIX starts decoding from the beginning of a symbol.
ADD delays the decoding start position by half a symbol.

Measurement Modes DEMDDEM

Examples :DISPlay:DDEMod:MView:DStart AUTO
determines the decoding start position automatically.

Related Commands :DISPlay:DDEMod:MView:FORMat, [:SENSE]:DDEMod:FORMat

:DISPlay:DDEMod:MView:FORMat(?)

Selects or queries the display format of the main view in the digital modulation analysis.

Syntax :DISPlay:DDEMod:MView:FORMat { OFF | IQVTime | FVTime | CONStE
| VECTor | EVM | MERRor | PERRor | IEYE | QEYE | TEYE | STABLE
| PVTTime | AMAM | AMPM | DAMam | DAMPm | CCDF | PDF }
:DISPlay:DDEMod:MView:FORMat?

Arguments The arguments and display formats are listed in Table 2-40:

Table 2-40: Main view display formats

Argument	Display format
OFF	Hides all measurement results
IQVTime	IQ level versus Time
FVTime	Frequency drift versus Time
CONSte	Constellation
VECTor	Vector
EVM	Error vector magnitude (EVM)
MERRor	Amplitude error
PERRor	Phase error
IEYE	Eye diagram (vertical axis: I data)
QEYE	Eye diagram (vertical axis: Q data)
TEYE	Eye diagram (vertical axis: Phase)
STABle	Symbol table
PVTime	Power versus Time
AMAM	AM/AM (vector)
AMPM	AM/PM (vector)
DAMam	AM/AM (dot)
DAMPm	AM/PM (dot)
CCDF	CCDF
PDF	PDF

NOTE. The argument *FVTime* is valid when [:SENSe]:DDEMod:FORMat is GFSK or FSK.

The argument *PVTime* is valid only when [:SENSe]:DDEMod:FORMat is ASK.

The display format is restricted by the modulation type. Refer to the RSA3408A User Manual for details.

Measurement Modes DEMDDEM

Examples :DISPlay:DDEMod:MVIew:FORMat IEYE
selects the eye diagram with I data along the vertical axis.

Related Commands :DISPlay:DDEMod:SVIew:FORMat, [:SENSe]:DDEMod:FORMat

:DISPlay:DDEMod:MVlew:HSSHift(?)

Selects or queries the Q data half symbol shift for an OQPSK modulation signal on the main view during the digital modulation analysis.

NOTE. This command is valid when [:SENSe]:DDEMod:FORMat is set to OQPSK. This command setting affects the :DISPlay:DDEMod:SVlew:HSSHift command setting immediately.

Syntax :DISPlay:DDEMod:MVlew:HSSHift { LEFT | NONE | RIGHT }
:DISPlay:DDEMod:MVlew:HSSHift?

Arguments LEFT shifts Q data by half a symbol in the negative direction on the time axis.
NONE does not shift Q data (default).
RIGHT shifts Q data by half a symbol in the positive direction on the time axis.

Measurement Modes DEMDDEM

Examples :DISPlay:DDEMod:MVlew:HSSHift LEFT
shifts Q data by half a symbol in the negative direction on the time axis.

Related Commands :DISPlay:DDEMod:SVlew:HSSHift, [:SENSe]:DDEMod:FORMat

:DISPlay:DDEMod:MView:RADix(?)

Selects or queries the base of symbols in the main view in the digital modulation analysis.

This command is valid only when :DISPlay:DDEMod:MView:FORMat is set to STABLE (symbol table).

Syntax :DISPlay:DDEMod:MView:RADix { BINary | OCTal | HEXadecimal }
:DISPlay:DDEMod:MView:RADix?

Arguments BINary selects binary notation.
OCTal selects octal notation.
HEXadecimal selects hexadecimal notation.

Measurement Modes DEMDDEM

Examples :DISPlay:DDEMod:MView:RADix BINary
selects binary notation for the symbol table.

Related Commands :DISPlay:DDEMod:MView:FORMat

:DISPlay:DDEMod:MView:X[:SCALe]:OFFSet(?)

Sets or queries the minimum horizontal value (left edge) in the main view during the digital modulation analysis.

This command is not available when :DISPlay:DDEMod:MView:FORMat is set to CONSTe, VECTor, IEYE, QEYE, TEYE, or STABLE.

Syntax :DISPlay:DDEMod:MView:X[:SCALe]:OFFSet <value>
:DISPlay:DDEMod:MView:X[:SCALe]:OFFSet?

Arguments <value>::=<NRf> specifies the minimum horizontal value in the main view. Refer to *Note on Horizontal Scaling* on page 2-184 for setting the scale.

Measurement Modes DEMDDEM

Examples :DISPlay:DDEMod:MView:X:SCALe:OFFSet -40us
sets the minimum horizontal value to -40 μ s when the main view displays IQ level versus time.

Related Commands :DISPlay:DDEMod:MView:FORMat

:DISPlay:DDEMod:MView:X[:SCALE]:RANGe(?)

Sets or queries the full-scale value of the horizontal axis in the main view during the digital modulation analysis.

This command is not available when :DISPlay:DDEMod:MView:FORMat is set to CONSTe, VECTor, IEYE, QEYE, TEYE, STABLE, AMAM, AMPM, DAMam or DAMPm.

Syntax :DISPlay:DDEMod:MView:X[:SCALE]:RANGe <value>

:DISPlay:DDEMod:MView:X[:SCALE]:RANGe?

Arguments <value> ::= <NRf> specifies the full-scale value of the horizontal axis in the main view. Refer to *Note on Horizontal Scaling* on page 2-184 for setting the scale.

Measurement Modes DEMDDEM

Examples :DISPlay:DDEMod:MView:X:SCALE:RANGe 40us
sets the full-scale value of the horizontal axis to 40 μ s when the main view displays IQ level versus time.

Related Commands :DISPlay:DDEMod:MView:FORMat

:DISPlay:DDEMod:MView:Y[:SCALE]:FIT (No Query Form)

Runs auto-scale on the main view during the digital modulation analysis. The auto-scale automatically sets the start value and scale of the vertical axis to display the whole waveform.

This command is not available when :DISPlay:DDEMod:MView:FORMat is set to CONSTe, VECTor, IEYE, QEYE, TEYE, STABLE, AMAM, AMPM, DAMam or DAMPm.

Syntax :DISPlay:DDEMod:MView:Y[:SCALE]:FIT

Arguments None

Measurement Modes DEMDDEM

Examples :DISPlay:DDEMod:MView:Y:SCALE:FIT
runs the auto-scale on the main view.

Related Commands :DISPlay:DDEMod:MView:FORMat

:DISPlay:DDEMod:MView:Y[:SCALE]:FULL (No Query Form)

Sets the vertical axis in the main view to the default full-scale value during the digital modulation analysis.

This command is not available when :DISPlay:DDEMod:MView:FORMat is set to CONSTe, VECTor, IEYE, QEYE, TEYE, STABLE, AMAM, AMPM, DAMam or DAMPm.

Syntax :DISPlay:DDEMod:MView:Y[:SCALE]:FULL

Arguments None

Measurement Modes DEMDDEM

Examples :DISPlay:DDEMod:MView:Y:SCALE:FULL
sets the main view's vertical axis to the default full-scale value.

Related Commands :DISPlay:DDEMod:MView:FORMat

:DISPlay:DDEMod:MView:Y[:SCALe]:MAXimum(?)

Sets or queries the maximum vertical value (top end) in the CCDF main view during the digital modulation analysis.

This command is valid when :DISPlay:DDEMod:MView:FORMat is set to CCDF.

Syntax :DISPlay:DDEMod:MView:Y[:SCALe]:MAXimum <value>
 :DISPlay:DDEMod:MView:Y[:SCALe]:MAXimum?

Arguments <value>::=<NRf> specifies the maximum vertical value in the CCDF view.
 Range: Twice of the minimum value to 100%

The minimum value is set using the :DISPlay:DDEMod:MView:Y[:SCALe]:MINimum command.

Measurement Modes DEMDDDEM

Examples :DISPlay:DDEMod:MView:Y:SCALe:MAXimum 80pct
 sets the maximum vertical value to 80% in the CCDF main view.

Related Commands :DISPlay:DDEMod:MView:Y[:SCALe]:MINimum

:DISPlay:DDEMod:MView:Y[:SCALe]:MINimum(?)

Sets or queries the minimum vertical value (bottom end) in the CCDF main view during the digital modulation analysis.

This command is valid when :DISPlay:DDEMod:MView:FORMat is set to CCDF.

Syntax :DISPlay:DDEMod:MView:Y[:SCALe]:MINimum <value>
:DISPlay:DDEMod:MView:Y[:SCALe]:MINimum?

Arguments <value>::=<NRf> specifies the minimum vertical value in the CCDF view.
Range: 0.01 to 1/2 of the maximum value in percent (%)

The maximum value is set using the :DISPlay:DDEMod:MView:Y[:SCALe]:MAXimum command.

Measurement Modes DEMDDEM

Examples :DISPlay:DDEMod:MView:Y:SCALe:MINimum 0.1pct
sets the minimum vertical value to 0.1% in the CCDF main view.

Related Commands :DISPlay:DDEMod:MView:Y[:SCALe]:MAXimum

:DISPlay:DDEMod:MVew:Y[:SCALE]:OFFSet(?)

Sets or queries the minimum vertical value (bottom) in the main view during the digital modulation analysis.

This command is not available when :DISPlay:DDEMod:MVew:FORMat is set to CONSTe, VECTor, IEYE, QEYE, TEYE, STABLE, AMPM, DAMPm, or CCDF.

The query command is valid when :DISPlay:DDEMod:MVew:FORMat is set to AMAM.

Syntax :DISPlay:DDEMod:MVew:Y[:SCALE]:OFFSet <value>

:DISPlay:DDEMod:MVew:Y[:SCALE]:OFFSet?

Arguments <value>::=<NRf> specifies the minimum vertical value in the main view. The valid range depends on the display format. Refer to Table D-1 in *Appendix D*.

Measurement Modes DEMDDEM

Examples :DISPlay:DDEMod:MVew:Y:SCALE:OFFSet -500mV
sets the minimum vertical value to -500 mV when the main view displays IQ level versus time.

Related Commands :DISPlay:DDEMod:MVew:FORMat

:DISPlay:DDEMod:MView:Y[:SCALe]:RANGe(?)

Sets or queries full-scale value of the vertical axis in the main view during the digital modulation analysis.

This command is not available when :DISPlay:DDEMod:MView:FORMat is set to CONSTe, VECTor, IEYE, QEYE, TEYE, STABLE, AMAM, DAMam, or CCDF.

Syntax :DISPlay:DDEMod:MView:Y[:SCALe]:RANGe <value>

:DISPlay:DDEMod:MView:Y[:SCALe]:RANGe?

Arguments <value>: :=<Nrf> specifies full-scale value of the vertical axis in the main view. The valid range depends on the display format. Refer to Table D-1 in *Appendix D*.

Measurement Modes DEMDDEM

Examples :DISPlay:DDEMod:MView:Y:SCALe:RANGe 500mV
sets full-scale value of the vertical axis to 500 mV when the the main view displays IQ level versus time.

Related Commands :DISPlay:DDEMod:MView:FORMat

:DISPlay:DDEMod:NLINearity:LINE:BFIT[:STATe](?)

Determines whether to display the best-fit line for the AM/AM or AM/PM measurement in the digital modulation analysis.

This command is valid only when :DISPlay:DDEMod:MView:FORMat is set to AMAM, AMPM, DAMam or DAMPm.

Syntax :DISPlay:DDEMod:NLINearity:LINE:BFIT[:STATe] { ON | OFF | 1 | 0 }
:DISPlay:DDEMod:NLINearity:LINE:BFIT[:STATe]?

Arguments ON or 1 shows the best-fit line.
OFF or 0 hides the best-fit line.

Measurement Modes DEMDDEM

Examples :DISPlay:DDEMod:NLINearity:LINE:BFIT:STATe ON
displays the best-fit line for AM/AM or AM/PM measurement.

Related Commands :DISPlay:DDEMod:MView:FORMat

:DISPlay:DDEMod:NLINearity:LINE:REFeRence[:STATe](?)

Determines whether to display the recovered reference line for AM/AM or AM/PM measurement in the digital modulation analysis.

This command is valid only when :DISPlay:DDEMod:MView:FORMat is set to AMAM, AMPM, DAMam or DAMPm.

Syntax :DISPlay:DDEMod:NLINearity:LINE:REFeRence[:STATe] { ON | OFF
| 1 | 0 }

:DISPlay:DDEMod:NLINearity:LINE:REFeRence[:STATe]?

Arguments ON or 1 shows the reference line.

OFF or 0 hides the reference line.

Measurement Modes DEMDDEM

Examples :DISPlay:DDEMod:NLINearity:LINE:REFeRence:STATe ON
displays the reference line for the AM/AM or AM/PM measurement.

Related Commands :DISPlay:DDEMod:MView:FORMat

:DISPlay:DDEMod:NLINearity:MASK[:STATe](?)

Determines whether the linear signal region is visible for the AM/AM measurement in the digital modulation analysis.

This command is valid only when :DISPlay:DDEMod:MView:FORMat is set to AMAM or DAMam.

Syntax :DISPlay:DDEMod:NLINearity:MASK[:STATe] { ON | OFF | 1 | 0 }
:DISPlay:DDEMod:NLINearity:MASK[:STATe]?

Arguments ON or 1 shows the linear signal region mask.
OFF or 0 hides the linear signal region mask.

Measurement Modes DEMDDEM

Examples :DISPlay:DDEMod:NLINearity:MASK:STATe ON
shows the linear signal region mask for the AM/AM measurement.

Related Commands :DISPlay:DDEMod:MView:FORMat

:DISPlay:DDEMod:SVIew:DStArt(?)

Selects or queries the decode start position for ASK, FSK, and GFSK modulation signals on the subview during the digital modulation analysis.

This command is valid when :DISPlay:DDEMod:SVIew:FORMat is set to STABLE (symbol table), and [:SENSe]:DDEMod:FORMat is set to ASK, FSK, or GFSK.

Syntax :DISPlay:DDEMod:SVIew:DStArt { AUTO | FIX | ADD }
:DISPlay:DDEMod:SVIew:DStArt?

Arguments AUTO searches for a possible pattern that matches the format.
FIX fixes the decode criterion inside.
ADD adds a half symbol delay before decoding.

Measurement Modes DEMDDEM

Examples :DISPlay:DDEMod:SVIew:DStArt AUTO
searches for a possible pattern that matches the format.

Related Commands :DISPlay:DDEMod:SVIew:FORMat, [:SENSe]:DDEMod:FORMat

:DISPlay:DDEMod:SVIew:FORMat(?)

Selects or queries the display format of the subview in the digital modulation analysis.

Syntax :DISPlay:DDEMod:SVIew:FORMat { SPECTrum | IQVTime | FVTime
| CONStE | VECTor | EVM | MERRor | PERRor | IEYE | QEYE | TEYE
| STABLE | PVTTime | AMAM | AMPM | DAMam | DAMPm | CCDF | PDF }
:DISPlay:DDEMod:SVIew:FORMat?

Arguments Table 2-41 shows the arguments and display formats.

Table 2-41: Subview display formats

Argument	Display format
SPECtrum	Spectrum
IQVTime	IQ level versus Time
FVTime	Frequency shift versus Time
CONSte	Constellation
VECTor	Vector
EVM	Error vector magnitude (EVM)
MERRor	Amplitude error
PERRor	Phase error
IEYE	Eye diagram (vertical axis: I data)
QEYE	Eye diagram (vertical axis: Q data)
TEYE	Eye diagram (vertical axis: Phase)
STABle	Symbol table
PVTime	Power versus Time
AMAM	AM/AM (vector)
AMPM	AM/PM (vector)
DAMam	AM/AM (dot)
DAMPm	AM/PM (dot)
CCDF	CCDF
PDF	PDF

NOTE. The argument *FVTime* is valid when [:SENSe]:DDEMod:FORMat is GFSK or FSK.

The argument *PVTime* is valid only when [:SENSe]:DDEMod:FORMat is ASK.

The display format is restricted by the modulation type. Refer to the RSA3408A User Manual for details.

Measurement Modes DEMDDEM

Examples :DISPlay:DDEMod:SVIew:FORMat CONSte
displays the constellation in the subview.

Related Commands :DISPlay:DDEMod:MVIew:FORMat, [:SENSe]:DDEMod:FORMat

:DISPlay:DDEMod:SVIew:HSSHift(?)

Selects or queries the Q data half symbol shift for an OQPSK modulation signal on the subview during the digital modulation analysis.

NOTE. This command is valid when [:SENSe]:DDEMod:FORMat is set to OQPSK. This command setting affects the :DISPlay:DDEMod:SVIew:HSSHift command setting immediately.

Syntax :DISPlay:DDEMod:SVIew:HSSHift { LEFT | NONE | RIGHT }
:DISPlay:DDEMod:SVIew:HSSHift?

Arguments LEFT shifts Q data by half a symbol in the negative direction on the time axis.
NONE does not shift Q data (default).
RIGHT shifts Q data by half a symbol in the positive direction on the time axis.

Measurement Modes DEMDDEM

Examples :DISPlay:DDEMod:SVIew:HSSHift LEFT
specifies that half a symbol of Q data is shifted to the left side.

Related Commands :DISPlay:DDEMod:SVIew:HSSHift, [:SENSe]:DDEMod:FORMat

:DISPlay:DDEMod:SVIew:RADix(?)

Selects or queries the base of symbols in the subview during the digital modulation analysis.

This command is valid when :DISPlay:DDEMod:SVIew:FORMat is set to STABLE (symbol table).

Syntax :DISPlay:DDEMod:SVIew:RADix { BINary | OCTal | HEXadecimal }
:DISPlay:DDEMod:SVIew:RADix?

Arguments BINary selects binary notation.
OCTal selects octal notation.
HEXadecimal selects hexadecimal notation.

Measurement Modes DEMDDEM

Examples :DISPlay:DDEMod:MVIew:RADix BINary
selects binary notation for the symbol table.

Related Commands :DISPlay:DDEMod:SVIew:FORMat

:DISPlay:DDEMod:SVIew:X[:SCALe]:OFFSet(?)

Sets or queries the minimum horizontal value (left edge) in the subview during the digital modulation analysis.

This command is not available when :DISPlay:DDEMod:SVIew:FORMat is set to CONSTe, VECTor, IEYE, QEYE, TEYE, or STABLE.

Syntax :DISPlay:DDEMod:SVIew:X[:SCALe]:OFFSet <value>
:DISPlay:DDEMod:SVIew:X[:SCALe]:OFFSet?

Arguments <value>::=<NRf> specifies the minimum horizontal value in the subview. Refer to *Note on Horizontal Scaling* on page 2-184 for setting the scale.

Measurement Modes DEMDDEM

Examples :DISPlay:DDEMod:SVIew:X:SCALe:OFFSet -2.5
sets the minimum horizontal value to -2.5 when the subview displays the constellation.

Related Commands :DISPlay:DDEMod:SVIew:FORMat

:DISPlay:DDEMod:SVIew:X[:SCALe]:RANGe(?)

Sets or queries full-scale value of the horizontal axis in the subview during the digital modulation analysis.

This command is not available when :DISPlay:DDEMod:MVIew:FORMat is set to CONSTe, VECTor, IEYE, QEYE, TEYE, STABLE, AMAM, AMPM, DAMam or DAMPm.

Syntax :DISPlay:DDEMod:SVIew:X[:SCALe]:RANGe <value>

:DISPlay:DDEMod:SVIew:X[:SCALe]:RANGe?

Arguments <value> ::= <NRf> specifies full-scale value of the horizontal axis in the subview. The valid range depends on the display format. Refer to Table D-1 in *Appendix D*.

Measurement Modes DEMDDEM

Examples :DISPlay:DDEMod:SVIew:X:SCALe:RANGe 2.5
sets full-scale value of the horizontal axis to 2.5 when the subview displays the constellation.

Related Commands :DISPlay:DDEMod:SVIew:FORMat

:DISPlay:DDEMod:SVIew:Y[:SCALe]:FIT (No Query Form)

Runs auto-scale on the subview during the digital modulation analysis. The auto-scale automatically sets the start value and scale of the vertical axis to display the whole waveform.

This command is not available when :DISPlay:DDEMod:MVIew:FORMat is set to CONSTe, VECTor, IEYE, QEYE, TEYE, STABLE, AMAM, AMPM, DAMam or DAMPm.

Syntax :DISPlay:DDEMod:SVIew:Y[:SCALe]:FIT

Arguments None

Measurement Modes DEMDDEM

Examples :DISPlay:DDEMod:SVIew:Y:SCALe:FIT
runs the auto-scale on the subview.

Related Commands :DISPlay:DDEMod:SVIew:FORMat

:DISPlay:DDEMod:SVIew:Y[:SCALe]:FULL (No Query Form)

Sets the vertical axis in the subview to the default full-scale value during the digital modulation analysis.

This command is not available when :DISPlay:DDEMod:MVIew:FORMat is set to CONSTe, VECTor, IEYE, QEYE, TEYE, STABLE, AMAM, AMPM, DAMam or DAMPm.

Syntax :DISPlay:DDEMod:SVIew:Y[:SCALe]:FULL

Arguments None

Measurement Modes DEMDDEM

Examples :DISPlay:DDEMod:SVIew:Y:SCALe:FULL
sets the vertical axis in the subview to the default full-scale value.

Related Commands :DISPlay:DDEMod:SVIew:FORMat

:DISPlay:DDEMod:SVIew:Y[:SCALe]:MAXimum(?)

Sets or queries the maximum vertical value (top end) in the CCDF subview during the digital modulation analysis.

This command is valid when :DISPlay:DDEMod:SVIew:FORMat is set to CCDF.

Syntax :DISPlay:DDEMod:SVIew:Y[:SCALe]:MAXimum <value>
 :DISPlay:DDEMod:SVIew:Y[:SCALe]:MAXimum?

Arguments <value>::=<NRf> specifies the maximum vertical value in the CCDF view.
 Range: Twice of the minimum value to 100%

The minimum value is set using the :DISPlay:DDEMod:SVIew:Y[:SCALe]:MINimum command.

Measurement Modes DEMDDEM

Examples :DISPlay:DDEMod:SVIew:Y:SCALe:MAXimum 80pct
 sets the maximum vertical value to 80% in the CCDF subview.

Related Commands :DISPlay:DDEMod:SVIew:Y[:SCALe]:MINimum

:DISPlay:DDEMod:SVIew:Y[:SCALe]:MINimum(?)

Sets or queries the minimum vertical value (bottom end) in the CCDF subview during the digital modulation analysis.

This command is valid when :DISPlay:DDEMod:SVIew:FORMat is set to CCDF.

Syntax :DISPlay:DDEMod:SVIew:Y[:SCALe]:MINimum <value>
:DISPlay:DDEMod:SVIew:Y[:SCALe]:MINimum?

Arguments <value>::=<NRf> specifies the minimum vertical value in the CCDF view.
Range: 0.01 to 1/2 of the maximum value in percent (%)

The maximum value is set using the :DISPlay:DDEMod:SVIew:Y[:SCALe]:MAXimum command.

Measurement Modes DEMDDEM

Examples :DISPlay:DDEMod:SVIew:Y:SCALe:MINimum 0.1pct
sets the minimum vertical value to 0.1% in the CCDF subview.

Related Commands :DISPlay:DDEMod:SVIew:Y[:SCALe]:MAXimum

:DISPlay:DDEMod:SVIew:Y[:SCALE]:OFFSet(?)

Sets or queries the minimum vertical value (bottom) in the subview during the digital modulation analysis.

This command is not available when :DISPlay:DDEMod:SVIew:FORMat is set to CONSTe, VECTor, IEYE, QEYE, TEYE, STABLE, AMPM, DAMPM, or CCDF.

The query command is valid when :DISPlay:DDEMod:SVIew:FORMat is set to AMAM.

Syntax :DISPlay:DDEMod:SVIew:Y[:SCALE]:OFFSet <value>

Arguments <value>::=<NRf> specifies the minimum vertical value in the subview. The valid range depends on the display format. Refer to Table D-1 in *Appendix D*.

Measurement Modes DEMDEM

Examples :DISPlay:DDEMod:SVIew:Y:SCALE:OFFSet -100
sets the minimum vertical value to -100 dBm when the subview displays spectrum.

Related Commands :DISPlay:DDEMod:SVIew:FORMat

:DISPlay:DDEMod:SVIew:Y[:SCALe]:RANGe(?)

Sets or queries full-scale value of the vertical axis in the subview during the digital modulation analysis.

This command is not available when :DISPlay:DDEMod:SVIew:FORMat is set to CONSTe, VECTor, IEYE, QEYE, TEYE, STABLE, AMAM, DAMam, or CCDF.

Syntax :DISPlay:DDEMod:SVIew:Y[:SCALe]:RANGe <value>

:DISPlay:DDEMod:SVIew:Y[:SCALe]:RANGe?

Arguments <value>: :=<NRf> specifies full-scale value of the vertical axis in the subview. The valid range depends on the display format. Refer to Table D-1 in *Appendix D*.

Measurement Modes DEMDDEM

Examples :DISPlay:DDEMod:SVIew:Y:SCALe:RANGe 100
sets full-scale value of the vertical axis to 100 dB when the subview displays spectrum.

Related Commands :DISPlay:DDEMod:SVIew:FORMat

:DISPlay:RFID:DDEMod Subgroup**RFID Analysis, Option 21 Only**

The :DISPlay:RFID:DDEMod commands control display of the main view and subview for the RFID modulation analysis. This command group is valid in the following measurements:

- Carrier
- Power on/down
- RF envelope
- Constellation
- Eye diagram
- Symbol table

NOTE. To use a command from this group, you must have selected DEMRFID (RFID modulation analysis) in the :INSTRument[:SElect] command.

Command Tree	Header	Parameter
	:DISPlay	
	:RFID	
	:DDEMod	
	:MView	
	:AREA	
	[:PERCent]	<numeric_value>
	:BURSt	
	[:NUMBer]	<numeric_value>
	:EDGE	
	[:NUMBer]	<numeric_value>
	:ENVELOpe	
	[:NUMBer]	<numeric_value>
	:GUIDeline	
	[:STATe]	<boolean>
	:X	
	[:SCALE]	
	:OFFSet	<numeric_value>
	:PDIVision	<numeric_value>
	:RANGE	<numeric_value>

```

:Y
  [:SCALE]
    :FIT
    :FULL
    :OFFSet <numeric_value>
    :PDIVision <numeric_value>
    :RANGe <numeric_value>
:SVIew
  :AREA
    [:PERCent] <numeric_value>
  :BURSt
    [:NUMBer] <numeric_value>
  :EDGE
    [:NUMBer] <numeric_value>
  :ENVELOpe
    [:NUMBer] <numeric_value>
  :FORMat SPECTrum | PVTime | FVTime
          | ZSPectrum | RFENvelope
          | CONSTe | VECTor | EYE | STABle
:GUIDeline
  [:STATe] <boolean>
:X
  [:SCALE]
    :OFFSet <numeric_value>
    :PDIVision <numeric_value>
    :RANGe <numeric_value>
:Y
  [:SCALE]
    :FIT
    :FULL
    :OFFSet <numeric_value>
    :PDIVision <numeric_value>
    :RANGe <numeric_value>

```

:DISPlay:RFID:DDEMod:MView:AREA[:PERCent](?)

Sets or queries the percentage of display area (sample points) from the beginning in the selected burst. This command is valid when [:SENse]:RFID:MEASurement is set to CONSTe (constellation) and EYE (eye diagram).

Syntax :DISPlay:RFID:DDEMod:MView:AREA[:PERCent] <value>
 :DISPlay:RFID:DDEMod:MView:AREA[:PERCent]?

Arguments <value>::=<NRf> specifies the percentage of area in the selected burst to display from the beginning.
 Range: 0.1 to 100% (default: 100%). 100% represents the whole burst.

Measurement Modes DEMRFID

Examples :DISPlay:RFID:DDEMod:MView:AREA:PERCent 90
 sets the display area to 90%.

Related Commands [:SENse]:RFID:MEASurement

:DISPlay:RFID:DDEMod:MView:BURSt[:NUMBer](?)

Sets or queries the burst number to display the measurement result in the main view. This command is valid when [:SENse]:RFID:MEASurement is set to RFENvelope, CONSTe, EYE, or STABLE.

Syntax :DISPlay:RFID:DDEMod:MView:BURSt[:NUMBer] <number>
 :DISPlay:RFID:DDEMod:MView:BURSt[:NUMBer]?

Arguments <number>::=<NR1> specifies the burst number. Range: 0 to 31.

Measurement Modes DEMRFID

Examples :DISPlay:RFID:DDEMod:MView:BURSt:NUMBer 5
 sets the burst number to 5.

Related Commands [:SENse]:RFID:MEASurement

:DISPlay:RFID:DDEMod:MView:EDGE[:NUMBER](?)

Sets or queries the edge number to display the measurement result in the main view. This command is valid when [:SENse]:RFID:MEASurement is set to PODown.

Syntax :DISPlay:RFID:DDEMod:MView:EDGE[:NUMBER] <number>
 :DISPlay:RFID:DDEMod:MView:EDGE[:NUMBER]?

Arguments <number>::=<NR1> specifies the edge number.
 Range: 0 to (the number of acquired edges) - 1.

Measurement Modes DEMRFID

Examples :DISPlay:RFID:DDEMod:MView:EDGE:NUMBER 5
 sets the edge number to 5.

Related Commands [:SENse]:RFID:MEASurement

:DISPlay:RFID:DDEMod:MView:ENVELOPE[:NUMBER](?)

Sets or queries the envelope number to display the measurement result in the main view. This command is valid when [:SENse]:RFID:MEASurement is set to RFENvelope, CONSTe, EYE, or STABLE.

Syntax :DISPlay:RFID:DDEMod:MView:ENVELOPE[:NUMBER] <number>
 :DISPlay:RFID:DDEMod:MView:ENVELOPE[:NUMBER]?

Arguments <number>::=<NR1> specifies the envelope number.
 Range: 0 to (the number of acquired envelopes) - 1.

Measurement Modes DEMRFID

Examples :DISPlay:RFID:DDEMod:MView:ENVELOPE:NUMBER 5
 sets the envelope number to 5.

Related Commands [:SENse]:RFID:MEASurement

:DISPlay:RFID:DDEMod:MView:GUIDeline[:STATe](?)

Determines whether to display the guideline in the main view during the RFID analysis. This command is valid when [:SENse]:RFID:MEASurement is set to RFENvelope, CONSte, EYE, or STABle.

Syntax :DISPlay:RFID:DDEMod:MView:GUIDeline[:STATe] { ON | OFF | 1 | 0 }
 :DISPlay:RFID:DDEMod:MView:GUIDeline[:STATe]?

Arguments ON or 1 shows the guideline in the main view.
 OFF or 0 hides the guideline in the main view.

Measurement Modes DEMRFID

Examples :DISPlay:RFID:DDEMod:MView:GUIDeline:STATe ON
 shows the guideline in the main view.

Related Commands [:SENse]:RFID:MEASurement

:DISPlay:RFID:DDEMod:MView:X[:SCALE]:OFFSet(?)

Sets or queries the minimum horizontal value (left edge) in the main view in the RFID analysis.

Syntax :DISPlay:RFID:DDEMod:MView:X[:SCALE]:OFFSet <value>

:DISPlay:RFID:DDEMod:MView:X[:SCALE]:OFFSet?

Arguments <value>::=<Nrf> specifies the minimum horizontal value in the main view. For the setting range, refer to *Note on Horizontal Scaling* on page 2-184.

Measurement Modes DEMRFID

Examples :DISPlay:RFID:DDEMod:MView:X:SCALE:OFFSet -100ms
sets the minimum horizontal value to -100 ms when the main view displays the RF envelope.

Related Commands [:SENse]:RFID:MEASurement

:DISPlay:RFID:DDEMod:MView:X[:SCALE]:PDIVision(?)

Sets or queries the horizontal scale (per division) in the main view during the RFID analysis.

Syntax :DISPlay:RFID:MView:X[:SCALE]:PDIVision <value>

:DISPlay:RFID:MView:X[:SCALE]:PDIVision?

Arguments <value>::=<Nrf> specifies the horizontal scale (per division) in the main view. For the setting range, refer to *Note on Horizontal Scaling* on page 2-184.

Measurement Modes DEMRFID

Examples :DISPlay:RFID:MView:X:SCALE:PDIVision 5ms
sets the horizontal scale to 5 ms/div when the main view displays the RF envelope.

Related Commands [:SENse]:RFID:MEASurement

:DISPlay:RFID:DDEMod:MView:X[:SCALe]:RANGe(?)

Sets or queries the full-scale value of the horizontal axis in the main view in the RFID analysis.

Syntax :DISPlay:RFID:DDEMod:MView:X[:SCALe]:RANGe <value>

 :DISPlay:RFID:DDEMod:MView:X[:SCALe]:RANGe?

Arguments <value>: :=<NRf> specifies the full-scale value of the horizontal axis in the main view. For the setting range, refer to *Note on Horizontal Scaling* on page 2-184.

Measurement Modes DEMRFID

Examples :DISPlay:RFID:DDEMod:MView:X:SCALe:RANGe 10MHz
 sets the full-scale value of the horizontal axis to 10 MHz when the main view displays the carrier spectrum.

Related Commands [:SENSe]:RFID:MEASurement

:DISPlay:RFID:DDEMod:MView:Y[:SCALE]:FIT (No Query Form)

Runs auto-scale on the main view in the RFID analysis.
The auto-scale automatically sets the start value and scale of the vertical axis to fit the waveform to the screen.

Syntax :DISPlay:RFID:DDEMod:MView:Y[:SCALE]:FIT

Arguments None

Measurement Modes DEMRFID

Examples :DISPlay:RFID:DDEMod:MView:Y:SCALE:FIT
runs the auto-scale on the main view.

Related Commands [:SENse]:RFID:MEASurement

:DISPlay:RFID:DDEMod:MView:Y[:SCALE]:FULL (No Query Form)

Sets the vertical axis in the main view to the default full-scale value in the RFID analysis.

Syntax :DISPlay:RFID:DDEMod:MView:Y[:SCALE]:FULL

Arguments None

Measurement Modes DEMRFID

Examples :DISPlay:RFID:DDEMod:MView:Y:SCALE:FULL
sets the main view's vertical axis to the default full-scale value.

Related Commands [:SENse]:RFID:MEASurement

:DISPlay:RFID:DDEMod:MView:Y[:SCALe]:OFFSet(?)

Sets or queries the minimum vertical value (bottom) of the main view in the RFID analysis.

Syntax :DISPlay:RFID:DDEMod:MView:Y[:SCALe]:OFFSet <value>

:DISPlay:RFID:DDEMod:MView:Y[:SCALe]:OFFSet?

Arguments <value>::=<Nrf> specifies the minimum vertical value in the main view. The valid range depends on the display format. Refer to Table D-3 in *Appendix D*.

Measurement Modes DEMRFID

Examples :DISPlay:RFID:DDEMod:MView:Y:SCALe:OFFSet -100
sets the minimum vertical value to -100 dBm when the main view displays the carrier spectrum.

Related Commands [:SENSe]:RFID:MEASurement

:DISPlay:RFID:DDEMod:MView:Y[:SCALe]:PDIVision(?)

Sets or queries the vertical scale (per division) of the main view in the RFID analysis.

Syntax :DISPlay:RFID:DDEMod:MView:Y[:SCALe]:PDIVision <value>

:DISPlay:RFID:DDEMod:MView:Y[:SCALe]:PDIVision?

Arguments <value>::=<Nrf> specifies the vertical scale (per division). The valid range depends on the display format. Refer to Table D-3 in *Appendix D*.

Measurement Modes DEMRFID

Examples :DISPlay:RFID:DDEMod:MView:Y:SCALe:PDIVision 5m
sets the vertical scale to 5 mV/div when the main view displays the RF envelope.

Related Commands [:SENSe]:RFID:MEASurement

:DISPlay:RFID:DDEMod:MView:Y[:SCALE]:RANGe(?)

Sets or queries full-scale value of the vertical axis of the main view in the RFID analysis.

Syntax :DISPlay:RFID:DDEMod:MView:Y[:SCALE]:RANGe <value>

:DISPlay:RFID:DDEMod:MView:Y[:SCALE]:RANGe?

Arguments <value>: :=<NRf> specifies full-scale value of the vertical axis in the main view. The valid range depends on the display format. Refer to Table D-3 in *Appendix D*.

Measurement Modes DEMRFID

Examples :DISPlay:RFID:DDEMod:MView:Y:SCALE:RANGe 100
sets full-scale value of the vertical axis to 100 dB when the main view displays the carrier spectrum.

Related Commands [:SENse]:RFID:MEASurement

:DISPlay:RFID:DDEMod:SVIew:AREA[:PERCent](?)

Sets or queries the percentage of display area (sample points) from the beginning in the selected burst. This command is valid when :DISPlay:RFID:DDEMod:SVIew:FORMat is set to CONSte (constellation) and EYE (eye diagram).

Syntax :DISPlay:RFID:DDEMod:MVIew:AREA[:PERCent] <value>
 :DISPlay:RFID:DDEMod:MVIew:AREA[:PERCent]?

Arguments <value>::=<NRf> specifies the percentage of area in the selected burst to display from the beginning.
 Range: 0.1 to 100% (default: 100%). 100% represents the whole burst.

Measurement Modes DEMRFID

Examples :DISPlay:RFID:DDEMod:MVIew:AREA:PERCent 90
 sets the display area to 90%.

Related Commands :DISPlay:RFID:DDEMod:SVIew:FORMat

:DISPlay:RFID:DDEMod:SVIew:BURSt[:NUMBer](?)

Sets or queries the burst number to display the measurement result in the subview. This command is valid when [:SENse]:RFID:MEASurement is set to RFENvelope, CONSte, EYE, or STABle.

Syntax :DISPlay:RFID:DDEMod:SVIew:BURSt[:NUMBer] <number>
 :DISPlay:RFID:DDEMod:SVIew:BURSt[:NUMBer]?

Arguments <number>::=<NR1> specifies the burst number. Range: 0 to 31.

Measurement Modes DEMRFID

Examples :DISPlay:RFID:DDEMod:SVIew:BURSt:NUMBer 5
 sets the burst number to 5.

Related Commands [:SENse]:RFID:MEASurement

:DISPlay:RFID:DDEMod:SVIew:EDGE[:NUMBER](?)

Sets or queries the edge number to display the measurement result in the subview. This command is valid when [:SENse]:RFID:MEASurement is set to PODown.

Syntax :DISPlay:RFID:DDEMod:SVIew:EDGE[:NUMBER] <number>
 :DISPlay:RFID:DDEMod:SVIew:EDGE[:NUMBER]?

Arguments <number>::=<NR1> specifies the edge number.
 Range: 0 to (the number of acquired edges) - 1.

Measurement Modes DEMRFID

Examples :DISPlay:RFID:DDEMod:SVIew:EDGE:NUMBER 5
 sets the edge number to 5.

Related Commands [:SENse]:RFID:MEASurement

:DISPlay:RFID:DDEMod:SVIew:ENVELOpe[:NUMBER](?)

Sets or queries the envelope number to display the measurement result in the subview. This command is valid when [:SENse]:RFID:MEASurement is set to RFENvelope, CONSTe, EYE, or STABLE.

Syntax :DISPlay:RFID:DDEMod:SVIew:ENVELOpe[:NUMBER] <number>
 :DISPlay:RFID:DDEMod:SVIew:ENVELOpe[:NUMBER]?

Arguments <number>::=<NR1> specifies the envelope number.
 Range: 0 to (the number of acquired envelopes) - 1.

Measurement Modes DEMRFID

Examples :DISPlay:RFID:DDEMod:SVIew:ENVELOpe:NUMBER 5
 sets the envelope number to 5.

Related Commands [:SENse]:RFID:MEASurement

:DISPlay:RFID:DDEMod:SVIew:FORMat(?)

Selects or queries the display format of the subview in the RFID analysis.

Syntax :DISPlay:RFID:DDEMod:SVIew:FORMat { SPECTrum | PVTime | FVTime
 | ZSPectrum | RFENvelope | CONSTe | VECTor | EYE | STABle }

 :DISPlay:RFID:DDEMod:SVIew:FORMat?

Arguments The arguments and display formats are listed below:

Table 2-42: Subview display formats

Argument	Display format
SPECTrum	Spectrum
PVTime	Power versus Time
FVTime	Frequency versus Time
ZSPectrum	Zoomed spectrum
RFENvelope	RF envelope
CONSTe	Constellation
VECTor	Vector
EYE	Eye diagram
STABle	Symbol table

Measurement Modes DEMRFID

Examples :DISPlay:RFID:DDEMod:SVIew:FORMat CONSTe
 displays the constellation in the subview.

Related Commands [:SENSe]:RFID:MEASurement

:DISPlay:RFID:DDEMod:SVIew:GUIDeline[:STATe](?)

Determines whether to display the guideline in the subview during the RFID analysis. This command is valid when [:SENSe]:RFID:MEASurement is set to RFENvelope, CONSt, EYE, or STABLe.

Syntax :DISPlay:RFID:DDEMod:SVIew:GUIDeline[:STATe] { ON | OFF | 1 | 0 }
 :DISPlay:RFID:DDEMod:SVIew:GUIDeline[:STATe]?

Arguments ON or 1 shows the guideline in the subview.
 OFF or 0 hides the guideline in the subview.

Measurement Modes DEMRFID

Examples :DISPlay:RFID:DDEMod:SVIew:GUIDeline:STATe ON
 shows the guideline in the subview.

Related Commands [:SENSe]:RFID:MEASurement

:DISPlay:RFID:DDEMod:SVIew:X[:SCALe]:OFFSet(?)

Sets or queries the minimum horizontal value (left edge) in the subview. This command is valid when :DISPlay:RFID:DDEMod:SVIew:FORMat is set to SPECTrum, PVTime, FVTime, ZSPectrum, or RFENvelope.

Syntax :DISPlay:RFID:DDEMod:SVIew:X[:SCALe]:OFFSet <value>
:DISPlay:RFID:DDEMod:SVIew:X[:SCALe]:OFFSet?

Arguments <value>::=<NRf> specifies the minimum horizontal value in the subview. For the setting range, refer to *Note on Horizontal Scaling* on page 2-184.

Measurement Modes DEMRFID

Examples :DISPlay:RFID:DDEMod:SVIew:X:SCALe:OFFSet -100ms
sets the minimum horizontal value to -100 ms when the subview displays the RF envelope.

Related Commands :DISPlay:RFID:DDEMod:SVIew:FORMat

:DISPlay:RFID:DDEMod:SVIew:X[:SCALe]:PDIVision(?)

Sets or queries the horizontal scale (per division) in the subview. This command is valid when :DISPlay:RFID:DDEMod:SVIew:FORMat is set to SPECTrum, PVTime, FVTime, ZSPectrum, or RFENvelope.

Syntax :DISPlay:RFID:DDEMod:SVIew:X[:SCALe]:PDIVision <value>
:DISPlay:RFID:DDEMod:SVIew:X[:SCALe]:PDIVision?

Arguments <value>::=<NRf> specifies the horizontal scale in the subview. For the setting range, refer to *Note on Horizontal Scaling* on page 2-184.

Measurement Modes DEMRFID

Examples :DISPlay:RFID:DDEMod:SVIew:X:SCALe:PDIVision 5ms
sets the horizontal scale to 5 ms/div when the subview displays the RF envelope.

Related Commands :DISPlay:RFID:DDEMod:SVIew:FORMat

:DISPlay:RFID:DDEMod:SVIew:X[:SCALe]:RANGe(?)

Sets or queries full-scale value of the horizontal axis in the subview.

This command is valid when :DISPlay:RFID:DDEMod:SVIew:FORMat is set to SPECtrum, PVTime, FVTime, ZSPectrum, or RFENvelope.

Syntax :DISPlay:RFID:DDEMod:SVIew:X[:SCALe]:RANGe <value>
 :DISPlay:RFID:DDEMod:SVIew:X[:SCALe]:RANGe?

Arguments <value>::=<Nrf> specifies full-scale value of the horizontal axis in the subview. For the setting range, refer to *Note on Horizontal Scaling* on page 2-184.

Measurement Modes DEMRFID

Examples :DISPlay:RFID:DDEMod:SVIew:X:SCALe:RANGe 10MHz
 sets full-scale value of the horizontal axis to 10 MHz when the subview displays the carrier spectrum.

Related Commands :DISPlay:RFID:DDEMod:SVIew:FORMat

:DISPlay:RFID:DDEMod:SVIew:Y[:SCALe]:FIT (No Query Form)

Runs auto-scale on the subview in the RFID analysis.
The auto-scale automatically sets the start value and scale of the vertical axis to fit the waveform to the screen.

This command is valid when :DISPlay:RFID:DDEMod:SVIew:FORMat is set to SPECTrum, PVTime, FVTime, ZSPectrum, or RFENvelope.

Syntax :DISPlay:RFID:DDEMod:SVIew:Y[:SCALe]:FIT

Arguments None

Measurement Modes DEMRFID

Examples :DISPlay:RFID:DDEMod:SVIew:Y:SCALe:FIT
runs the auto-scale on the subview.

Related Commands :DISPlay:RFID:DDEMod:SVIew:FORMat

:DISPlay:RFID:DDEMod:SVIew:Y[:SCALe]:FULL (No Query Form)

Sets the vertical axis in the subview to the default full-scale value.

This command is valid when :DISPlay:RFID:DDEMod:SVIew:FORMat is set to SPECTrum, PVTime, FVTime, ZSPectrum, or RFENvelope.

Syntax :DISPlay:RFID:DDEMod:SVIew:Y[:SCALe]:FULL

Arguments None

Measurement Modes DEMRFID

Examples :DISPlay:RFID:DDEMod:SVIew:Y:SCALe:FULL
sets the vertical axis in the subview to the default full-scale value.

Related Commands :DISPlay:RFID:DDEMod:SVIew:FORMat

:DISPlay:RFID:DDEMod:SVIew:Y[:SCALe]:OFFSet(?)

Sets or queries the minimum vertical value (bottom) in the subview. This command is valid when :DISPlay:RFID:DDEMod:SVIew:FORMat is set to SPECTrum, PVTime, FVTime, ZSPectrum, or RFENvelope.

Syntax :DISPlay:RFID:DDEMod:SVIew:Y[:SCALe]:OFFSet <value>
:DISPlay:RFID:DDEMod:SVIew:Y[:SCALe]:OFFSet?

Arguments <value>::=<Nrf> specifies the minimum vertical value in the subview. The valid range depends on the display format. Refer to Table D-3 in *Appendix D*.

Measurement Modes DEMRFID

Examples :DISPlay:RFID:DDEMod:SVIew:Y:SCALe:OFFSet -100
sets the minimum vertical value to -100 dBm when the subview displays the spectrum.

Related Commands :DISPlay:RFID:DDEMod:SVIew:FORMat

:DISPlay:RFID:DDEMod:SVIew:Y[:SCALe]:PDIVision(?)

Sets or queries the vertical scale (per division) in the subview. This command is valid when :DISPlay:RFID:DDEMod:SVIew:FORMat is set to SPECTrum, PVTime, FVTime, ZSPectrum, or RFENvelope.

Syntax :DISPlay:RFID:DDEMod:SVIew:Y[:SCALe]:PDIVision <value>
:DISPlay:RFID:DDEMod:SVIew:Y[:SCALe]:PDIVision?

Arguments <value>::=<Nrf> specifies the vertical scale (per division). The valid range depends on the display format. Refer to Table D-3 in *Appendix D*.

Measurement Modes DEMRFID

Examples :DISPlay:RFID:DDEMod:SVIew:Y:SCALe:PDIVision 5m
sets the vertical scale to 5 mV/div when the subview displays the RF envelope.

Related Commands :DISPlay:RFID:DDEMod:SVIew:FORMat

:DISPlay:RFID:DDEMod:SVIew:Y[:SCALe]:RANGe(?)

Sets or queries full-scale value of the vertical axis in the subview.

This command is valid when :DISPlay:RFID:DDEMod:SVIew:FORMat is set to SPECTrum, PVTime, FVTime, ZSPectrum, or RFENvelope.

Syntax :DISPlay:RFID:DDEMod:SVIew:Y[:SCALe]:RANGe <value>
 :DISPlay:RFID:DDEMod:SVIew:Y[:SCALe]:RANGe?

Arguments <value>::=<NRf> specifies full-scale value of the vertical axis in the subview. The valid range depends on the display format. Refer to Table D-3 in *Appendix D*.

Measurement Modes DEMRFID

Examples :DISPlay:RFID:DDEMod:SVIew:Y:SCALe:RANGe 100
 sets full-scale value of the vertical axis to 100 dB when the subview displays the carrier spectrum.

Related Commands :DISPlay:RFID:DDEMod:SVIew:FORMat

:DISPlay:RFID:SPECTrum Subgroup**RFID Analysis, Option 21 Only**

The :DISPlay:RFID:SPECTrum commands control the spectrum display in the RFID (Radio Frequency Identification) measurement.

NOTE. To use a command from this group, you must have selected DEMRFID (RFID analysis) in the :INSTRument[:SElect] command.

Command Tree	Header	Parameter
	:DISPlay	
	:RFID	
	:SPECTrum	
	:X	
	[:SCALE]	
	:OFFSet	<frequency>
	:PDIVision	<frequency>
	:Y	
	[:SCALE]	
	:FIT	
	:FULL	
	:OFFSet	<amplitude>
	:PDIVision	<amplitude>

:DISPlay:RFID:SPECTrum:X[:SCALE]:OFFSet(?)

Sets or queries the minimum horizontal, or frequency, value (left edge) in the spectrum view.

Syntax :DISPlay:RFID:SPECTrum:X[:SCALE]:OFFSet <freq>

:DISPlay:RFID:SPECTrum:X[:SCALE]:OFFSet?

Arguments <freq>::=<Nrf> specifies the minimum horizontal value in the spectrum view. Refer to *Note on Horizontal Scaling* on page 2-184 for setting the scale.

Measurement Modes DEMRFID

Examples :DISPlay:RFID:SPECTrum:X:SCALE:OFFSet 100MHz
sets the minimum horizontal value to 100 MHz.

:DISPlay:RFID:SPECTrum:X[:SCALE]:PDIVision(?)

Sets or queries the horizontal, or frequency, scale (per division) in the spectrum view.

Syntax :DISPlay:RFID:SPECTrum:X[:SCALE]:PDIVision <freq>

:DISPlay:RFID:SPECTrum:X[:SCALE]:PDIVision?

Arguments <freq>::=<Nrf> specifies the horizontal scale (per division). Refer to *Note on Horizontal Scaling* on page 2-184 for setting the scale.

Measurement Modes DEMRFID

Examples :DISPlay:RFID:SPECTrum:X:SCALE:PDIVision 100.0E+3
sets the horizontal scale to 100 kHz/div.

:DISPlay:RFID:SPECTrum:Y[:SCALe]:FIT (No Query Form)

Runs auto-scale on the spectrum view.

The auto-scale automatically sets the start value and scale of the vertical axis to fit the waveform to the screen.

Syntax :DISPlay:RFID:SPECTrum:Y[:SCALe]:FIT

Arguments None

Measurement Modes DEMRFID

Examples :DISPlay:RFID:SPECTrum:Y:SCALe:FIT
runs the auto-scale on the spectrum view.

:DISPlay:RFID:SPECTrum:Y[:SCALe]:FULL (No Query Form)

Sets the vertical axis to the default full-scale value in the spectrum view.

Syntax :DISPlay:RFID:SPECTrum:Y[:SCALe]:FULL

Arguments None

Measurement Modes DEMRFID

Examples :DISPlay:RFID:SPECTrum:Y:SCALe:FULL
sets the vertical axis to the default full-scale value in the spectrum view.

:DISPlay:RFID:SPECTrum:Y[:SCALe]:OFFSet(?)

Sets or queries the minimum vertical, or amplitude, value (bottom) in the spectrum view.

Syntax :DISPlay:RFID:SPECTrum:Y[:SCALe]:OFFSet <ampl>

 :DISPlay:RFID:SPECTrum:Y[:SCALe]:OFFSet?

Arguments <ampl>: :=<NRf> sets the minimum vertical value. Range: -200 to 0 dBm.

Measurement Modes DEMRFID

Examples :DISPlay:RFID:SPECTrum:Y:SCALe:OFFSet -100
 sets the minimum vertical value to -100 dBm.

:DISPlay:RFID:SPECTrum:Y[:SCALe]:PDIVision(?)

Sets or queries the vertical, or amplitude, scale (per division) in the spectrum view.

Syntax :DISPlay:RFID:SPECTrum:Y[:SCALe]:PDIVision <ampl>

 :DISPlay:RFID:SPECTrum:Y[:SCALe]:PDIVision?

Arguments <ampl>: :=<NRf> specifies the vertical scale in the spectrum view.
 Range: 0 to 10 dB/div.

Measurement Modes DEMRFID

Examples :DISPlay:RFID:SPECTrum:Y:SCALe:PDIVision 10
 sets the vertical scale to 10 dB/div.

:DISPlay:RFID:WAVeform Subgroup**RFID Analysis, Option 21 Only**

The :DISPlay:RFID:WAVeform commands control the time domain display in the RFID (Radio Frequency Identification) measurement.

NOTE. To use a command from this group, you must have selected DEMRFID (RFID analysis) in the :INSTRument[:SElect] command.

Command Tree	Header	Parameter
	:DISPlay	
	:RFID	
	:WAVeform	
	:X	
	[:SCALE]	
	:OFFSet	<time>
	:PDIVsion	<time>
	:Y	
	[:SCALE]	
	:FIT	
	:FULL	
	:OFFSet	<amplitude>
	:PDIVsion	<amplitude>

:DISPlay:RFID:WAVeform:X[:SCALe]:OFFSet(?)

Sets or queries the minimum value of the horizontal axis (left edge) in the time domain display.

Syntax :DISPlay:RFID:WAVeform:X[:SCALe]:OFFSet <time>

 :DISPlay:RFID:WAVeform:X[:SCALe]:OFFSet?

Arguments <time>::=<NRf> sets the minimum horizontal value.
Refer to *Note on Horizontal Scaling* on page 2-184 for setting the scale.

Measurement Modes DEMRFID

Examples :DISPlay:RFID:WAVeform:X:SCALe:OFFSet -100us
sets the minimum horizontal value to -100 μ s.

:DISPlay:RFID:WAVeform:X[:SCALe]:PDIVision(?)

Sets or queries the horizontal, or time, scale (per division) in the time domain display.

Syntax :DISPlay:RFID:WAVeform:X[:SCALe]:PDIVision <time>

 :DISPlay:RFID:WAVeform:X[:SCALe]:PDIVision?

Arguments <time>::=<NRf> specifies the horizontal scale.
Refer to *Note on Horizontal Scaling* on page 2-184 for setting the scale.

Measurement Modes DEMRFID

Examples :DISPlay:RFID:WAVeform:X:SCALe:PDIVision 10us
sets the horizontal scale to 10 μ s/div.

:DISPlay:RFID:WAVeform:Y[:SCALe]:FIT (No Query Form)

Runs auto-scale on the time domain display. The auto-scale automatically sets the start value and scale of the vertical axis to fit the waveform to the screen.

Syntax :DISPlay:RFID:WAVeform:Y[:SCALe]:FIT

Arguments None

Measurement Modes DEMRFID

Examples :DISPlay:RFID:WAVeform:Y:SCALe:FIT
runs the auto-scale.

:DISPlay:RFID:WAVeform:Y[:SCALe]:FULL (No Query Form)

Sets the vertical axis in the time domain display to the default full-scale value.

Syntax :DISPlay:RFID:WAVeform:Y[:SCALe]:FULL

Arguments None

Measurement Modes DEMRFID

Examples :DISPlay:RFID:WAVeform:Y:SCALe:FULL
sets the vertical axis in the time domain display to the default full-scale value.

:DISPlay:RFID:WAVEform:Y[:SCALE]:OFFSet(?)

Sets or queries the minimum value (bottom) of the vertical axis in the time domain display.

Syntax :DISPlay:RFID:WAVEform:Y[:SCALE]:OFFSet <amp1>

 :DISPlay:RFID:WAVEform:Y[:SCALE]:OFFSet?

Arguments <amp1>: :=<NRf> specifies the minimum value of the vertical axis.
For the setting range, refer to Table D-1 in *Appendix D*.

Measurement Modes DEMRFID

Examples :DISPlay:RFID:WAVEform:Y:SCALE:OFFSet -100
sets the minimum vertical value to -100 dBm.

:DISPlay:RFID:WAVEform:Y[:SCALE]:PDIVision(?)

Sets the vertical axis scale (per division) in the time domain display.

Syntax :DISPlay:RFID:WAVEform:Y[:SCALE]:PDIVision <amp1>

 :DISPlay:RFID:WAVEform:Y[:SCALE]:PDIVision?

Arguments <amp1>: :=<NRf> specifies the vertical scale.
For the setting range, refer to Table D-1 in *Appendix D*.

Measurement Modes DEMRFID

Examples :DISPlay:RFID:WAVEform:Y:SCALE:PDIVision 10
sets the vertical scale to 10 dB/div.

:DISPlay:SSource:MView Subgroup**Signal Source Analysis, Option 21 Only**

The :DISPlay:SSource:MView commands control display of the main view in the signal source analysis.

NOTE. To use a command from this group, you must have selected TIMSSOURCE (signal source analysis) in the :INSTRument[:SElect] command.

Command Tree	Header	Parameter
	:DISPlay	
	:SSource	
	:MView	
	:X	
	[:SCALE]	
	:OFFSet	<numeric_value>
	:PDIVision	<numeric_value>
	:RANGe	<numeric_value>
	:STARt	<numeric_value>
	:STOP	<numeric_value>
	:Y	
	[:SCALE]	
	:FIT	
	:FULL	
	:OFFSet	<numeric_value>
	:PDIVision	<numeric_value>
	:RANGe	<numeric_value>

:DISPlay:SSource:MView:X[:SCALE]:OFFSet(?)

Sets or queries the minimum horizontal value (left edge) in the main view during the signal source analysis.

This command is valid when [:SENSe]:SSource:MEASurement is set to SPURious (spurious), RTSPurious (real-time spurious), or FVTime (frequency versus time).

Syntax :DISPlay:SSource:MView:X[:SCALE]:OFFSet <value>

:DISPlay:SSource:MView:X[:SCALE]:OFFSet?

Arguments <value> ::= <NRf> specifies the minimum horizontal value in the main view. For the setting range, refer to *Note on Horizontal Scaling* on page 2-184.

Measurement Modes TIMSSOURCE

Examples :DISPlay:SSource:MView:X:SCALE:OFFSet 950MHz
sets the minimum horizontal value to 950 MHz when the main view displays the spurious.

Related Commands [:SENSe]:SSource:MEASurement

:DISPlay:SSource:MView:X[:SCALe]:PDIVision(?)

Sets or queries the horizontal scale (per division) in the main view during the signal source analysis.

This command is valid when [:SENSe]:SSource:MEASurement is set to SPURious (spurious), RTSPurious (real-time spurious), or FVTime (frequency versus time).

Syntax :DISPlay:SSource:MView:X[:SCALe]:PDIVision <value>

:DISPlay:SSource:MView:X[:SCALe]:PDIVision?

Arguments <value>::=<NRf> specifies the horizontal scale (per division) in the main view. For the setting range, refer to *Note on Horizontal Scaling* on page 2-184.

Measurement Modes TIMSSOURCE

Examples :DISPlay:SSource:MView:X:SCALe:PDIVision 1us
sets the horizontal scale to 1 μ s/div when the main view displays the frequency versus time.

Related Commands [:SENSe]:SSource:MEASurement

:DISPlay:SSource:MView:X[:SCALe]:RANGe(?)

Sets or queries the full-scale value of the horizontal axis in the main view during the signal source analysis.

This command is valid when [:SENSe]:SSource:MEASurement is set to SPURious (spurious), RTSPurious (real-time spurious), or FVTime (frequency versus time).

Syntax :DISPlay:SSource:MView:X[:SCALe]:RANGe <value>

:DISPlay:SSource:MView:X[:SCALe]:RANGe?

Arguments <value>::=<NRf> specifies the full-scale value of the horizontal axis in the main view. For the setting range, refer to *Note on Horizontal Scaling* on page 2-184.

Measurement Modes TIMSSOURCE

Examples :DISPlay:SSource:MView:X:SCALe:RANGe 10MHz
sets the full-scale value of the horizontal axis to 10 MHz when the main view displays the spurious.

Related Commands [:SENSe]:SSource:MEASurement

:DISPlay:SSource:MVlew:X[:SCALe]:START(?)

Sets or queries the minimum horizontal value (left edge) in the main view of the phase noise measurement.

This command is valid when [:SENSe]:SSource:MEASurement is set to PNOise (phase noise) or RTPNOise (real-time phase noise)

Syntax :DISPlay:SSource:MVlew:X[:SCALe]:START <value>
 :DISPlay:SSource:MVlew:X[:SCALe]:START?

Arguments <value>::=<NRf> specifies the minimum horizontal value in the main view. For the setting range, refer to *Note on Horizontal Scaling* on page 2-184.

Measurement Modes TIMSSOURCE

Examples :DISPlay:SSource:MVlew:X:SCALe:START 1kHz
 sets the minimum horizontal value to 1 kHz in the main view of the phase noise measurement.

Related Commands [:SENSe]:SSource:MEASurement

:DISPlay:SSource:MVlew:X[:SCALe]:STOP(?)

Sets or queries the maximum horizontal value (right edge) in the main view of the phase noise measurement.

This command is valid when [:SENSe]:SSource:MEASurement is set to PNOise (phase noise) or RTPNoise (real-time phase noise)

Syntax :DISPlay:SSource:MVlew:X[:SCALe]:STOP <value>
 :DISPlay:SSource:MVlew:X[:SCALe]:STOP?

Arguments <value>::=<NRf> specifies the maximum horizontal value in the main view. For the setting range, refer to *Note on Horizontal Scaling* on page 2-184.

Measurement Modes TIMSSOURCE

Examples :DISPlay:SSource:MVlew:X:SCALe:STOP 1MHz
 sets the maximum horizontal value to 1 MHz in the main view of the phase noise measurement.

Related Commands [:SENSe]:SSource:MEASurement

:DISPlay:SSource:MView:Y[:SCALe]:FIT (No Query Form)

Runs auto-scale on the main view during the signal source analysis.
The auto-scale automatically sets the start value and scale of the vertical axis to fit the waveform to the screen.

Syntax :DISPlay:SSource:MView:Y[:SCALe]:FIT

Arguments None

Measurement Modes TIMSSOURCE

Examples :DISPlay:SSource:MView:Y:SCALe:FIT
runs the auto-scale on the main view.

Related Commands [:SENSe]:SSource:MEASurement

:DISPlay:SSource:MView:Y[:SCALe]:FULL (No Query Form)

Sets the vertical axis in the main view to the default full-scale value during the signal source analysis.

Syntax :DISPlay:SSource:MView:Y[:SCALe]:FULL

Arguments None

Measurement Modes TIMSSOURCE

Examples :DISPlay:SSource:MView:Y:SCALe:FULL
sets the main view's vertical axis to the default full-scale value.

Related Commands [:SENSe]:SSource:MEASurement

:DISPlay:SSource:MView:Y[:SCALe]:OFFSet(?)

Sets or queries the minimum vertical value (bottom) in the main view during the signal source analysis.

Syntax :DISPlay:SSource:MView:Y[:SCALe]:OFFSet <value>

 :DISPlay:SSource:MView:Y[:SCALe]:OFFSet?

Arguments <value>::=<NRf> specifies the minimum vertical value in the main view. The valid range depends on the display format. Refer to Table D-4 in *Appendix D*.

Measurement Modes TIMSSOURCE

Examples :DISPlay:SSource:MView:Y:SCALe:OFFSet -100
 sets the minimum vertical value to -100 dBc/Hz in the main view of the phase noise measurement.

Related Commands [:SENSe]:SSource:MEASurement

:DISPlay:SSource:MView:Y[:SCALe]:PDIVision(?)

Sets or queries the vertical scale (per division) in the main view during the signal source analysis.

Syntax :DISPlay:SSource:MView:Y[:SCALe]:PDIVision <value>

 :DISPlay:SSource:MView:Y[:SCALe]:PDIVision?

Arguments <value>::=<NRf> specifies the vertical scale in the main view. For the setting range, refer to Table D-4 in *Appendix D*.

Measurement Modes TIMSSOURCE

Examples :DISPlay:SSource:MView:Y:SCALe:PDIVision 50kHz
 sets the vertical scale to 50 kHz/div in the main view of the frequency versus time measurement.

Related Commands [:SENSe]:SSource:MEASurement

:DISPlay:SSource:MView:Y[:SCALe]:RANGe(?)

Sets or queries full-scale value of the vertical axis in the main view during the signal source analysis.

Syntax :DISPlay:SSource:MView:Y[:SCALe]:RANGe <value>

:DISPlay:SSource:MView:Y[:SCALe]:RANGe?

Arguments <value>: :=<NRf> specifies full-scale value of the vertical axis in the main view. The valid range depends on the display format. Refer to Table D-4 in *Appendix D*.

Measurement Modes TIMSSOURCE

Examples :DISPlay:SSource:MView:Y:SCALe:RANGe 100
sets the vertical full-scale value to 100 dB in the main view of the phase noise measurement.

Related Commands [:SENSe]:SSource:MEASurement

:DISPlay:SSource:SVIew Subgroup**Signal Source Analysis, Option 21 Only**

The :DISPlay:SSource commands control display of the subview in the signal source analysis. This command group is valid in the following measurements:

- Real-time phase noise
- Real-time spurious

NOTE. To use a command from this group, you must have selected TIMSSOURCE (signal source analysis) in the :INSTrument[:SElect] command.

The :DISPLay:SSource:SVIew commands are valid when [:SENSe]:SSource:MEASurement is set to RTPNoise (real-time phase noise) or RTSPurious (real-time spurious).

Command Tree	Header	Parameter
	:DISPlay	
	:SSource	
	:SVIew	
	:COLor	
	[:SCALE]	
	:OFFSet	<numeric_value>
	:RANGe	<numeric_value>
	:FORMat	SPECTrum NGRam RJVTime IPNVtime CNVTime CNVFrequency
	:X	
	[:SCALE]	
	:OFFSet	<numeric_value>
	:PDIVision	<numeric_value>
	:RANGe	<numeric_value>
	:START	<numeric_value>
	:STOP	<numeric_value>
	:Y	
	[:SCALE]	
	:FIT	
	:FULL	
	:OFFSet	<numeric_value>
	:PDIVision	<numeric_value>
	:PLINe	<numeric_value>
	:RANGe	<numeric_value>

:DISPlay:SSource:SVIew:COLor[:SCALE]:OFFSet(?)

Sets or queries the minimum value (bottom) of the color axis in the subview displaying a noisogram.

This command is valid when :DISPlay:SSource:SVIew:FORMat is set to NGRam.

Syntax :DISPlay:SSource:SVIew:COLor[:SCALE]:OFFSet <value>
:DISPlay:SSource:SVIew:COLor[:SCALE]:OFFSet?

Arguments <amp1>: :=<NRf> specifies the minimum color-axis value in the subview.
Range: -230 to +70 dBc/Hz.

Measurement Modes TIMSSOURCE

Examples :DISPlay:SSource:SVIew:COLor:SCALE:OFFSet -100
sets the minimum color-axis value to -100 dBc/Hz.

:DISPlay:SSource:SVIew:COLor[:SCALE]:RANGe(?)

Sets or queries full-scale value of the color axis (C/N) in the subview displaying a noisogram.

This command is valid when :DISPlay:SSource:SVIew:FORMat is set to NGRam.

Syntax :DISPlay:SSource:SVIew:COLor[:SCALE]:RANGe <value>
:DISPlay:SSource:SVIew:COLor[:SCALE]:RANGe?

Arguments <rel_amp1>: :={ 10 | 20 | 50 | 100 } [dB] specifies the full-scale value of the color axis.

Measurement Modes TIMSSOURCE

Examples :DISPlay:SSource:SVIew:COLor:SCALE:RANGe 100
sets full-scale value of the color axis to 100 dB.

:DISPlay:SSource:SVIew:FORMat(?)

Selects or queries the display format of the subview in the signal source analysis.

Syntax :DISPlay:SSource:SVIew:FORMat { SPECTrum | NGRam | RJVTime
| IPNVtime | CNVTime | CNVFrequency }

:DISPlay:SSource:SVIew:FORMat?

Arguments The arguments and display formats are listed in Table 2-43. The subview format depends on the main view format as shown in the table.

Table 2-43: Subview display formats in the signal source analysis

Argument	Subview display format	Measurement ¹
SPECTrum	Spectrum	RTPNoise or RTSPurious
NGRam	Noisogram	RTPNoise or RTSPurious
RJVTime	Random jitter versus Time	RTPNoise
IPNVtime	Integrated phase noise versus Time	RTPNoise
CNVTime	C/N versus Time	RTPNoise
CNVFrequency	C/N versus Offset frequency	RTSPurious

¹ Use the [:SENSe]:SSource:MEASurement command to select the measurement item.

Measurement Modes TIMSSOURCE

Examples :DISPlay:SSource:SVIew:FORMat NGRam
selects the noisogram for the subview display format.

Related Commands [:SENSe]:SSource:MEASurement

:DISPlay:SSource:SVIew:X[:SCALe]:OFFSet(?)

Sets or queries the minimum horizontal value (left edge) in the subview during the signal source analysis.

This command is valid when :DISPlay:SSource:SVIew:FORMat is set to SPECTrum, RJVTime, IPNVtime, or CNVTime.

Syntax :DISPlay:SSource:SVIew:X[:SCALe]:OFFSet <value>
:DISPlay:SSource:SVIew:X[:SCALe]:OFFSet?

Arguments <value>::=<NRf> specifies the minimum horizontal value in the subview. For the setting range, refer to *Note on Horizontal Scaling* on page 2-184.

Measurement Modes TIMSSOURCE

Examples :DISPlay:SSource:SVIew:X:SCALe:OFFSet 1GHz
sets the minimum horizontal value to 1 GHz when the subview displays the spectrum.

Related Commands :DISPlay:SSource:SVIew:FORMat

:DISPlay:SSource:SVIew:X[:SCALe]:PDIVision(?)

Sets or queries the horizontal scale (time per division) in the subview during the signal source analysis.

This command is valid when :DISPlay:SSource:SVIew:FORMat is set to SPECTrum, RJVTime, IPNVtime, or CNVTime.

Syntax :DISPlay:SSource:SVIew:X[:SCALe]:PDIVision <value>
 :DISPlay:SSource:SVIew:X[:SCALe]:PDIVision?

Arguments <value>::=<NRf> specifies the horizontal scale in the subview.
For the setting range, refer to *Note on Horizontal Scaling* on page 2-184.

Measurement Modes TIMSSOURCE

Examples :DISPlay:SSource:SVIew:X:SCALe:PDIVision 1us
sets the horizontal scale to 1 μ s/div when the subview displays the random jitter versus time.

Related Commands :DISPlay:SSource:SVIew:FORMat

:DISPlay:SSource:SVIew:X[:SCALe]:RANGe(?)

Sets or queries the full-scale value of the horizontal axis in the subview during the signal source analysis.

This command is valid when :DISPlay:SSource:SVIew:FORMat is set to SPECtrum, RJVTime, IPNVtime, or CNVTime.

Syntax :DISPlay:SSource:SVIew:X[:SCALe]:RANGe <value>
:DISPlay:SSource:SVIew:X[:SCALe]:RANGe?

Arguments <value>::=<NRf> specifies the full-scale value of the horizontal axis in the subview. For the setting range, refer to *Note on Horizontal Scaling* on page 2-184.

Measurement Modes TIMSSOURCE

Examples :DISPlay:SSource:SVIew:X:SCALe:RANGe 10MHz
sets the full-scale value of the horizontal axis to 10 MHz when the subview displays the spectrum.

Related Commands :DISPlay:SSource:SVIew:FORMat

:DISPlay:SSource:SVIew:X[:SCALe]:START(?)

Sets or queries the minimum horizontal value (left edge) in the subview during the signal source analysis.

This command is valid when :DISPlay:SSource:SVIew:FORMat is set to NGRam or CNVFrequency.

Syntax :DISPlay:SSource:SVIew:X[:SCALe]:START <value>
 :DISPlay:SSource:SVIew:X[:SCALe]:START?

Arguments <value>::=<NRf> specifies the minimum horizontal value in the main view. For the setting range, refer to *Note on Horizontal Scaling* on page 2-184.

Measurement Modes TIMSSOURCE

Examples :DISPlay:SSource:SVIew:X:SCALe:START 1kHz
 sets the minimum horizontal value to 1 kHz in the subview displaying noisogram.

Related Commands :DISPlay:SSource:SVIew:FORMat

:DISPlay:SSource:SVIew:X[:SCALe]:STOP(?)

Sets or queries the maximum horizontal value (right edge) in the subview during the signal source analysis.

This command is valid when :DISPlay:SSource:SVIew:FORMat is set to NGRam or CNVFrequency.

Syntax :DISPlay:SSource:SVIew:X[:SCALe]:STOP <value>
:DISPlay:SSource:SVIew:X[:SCALe]:STOP?

Arguments <value>: :=<NRf> specifies the maximum horizontal value in the subview. For the setting range, refer to *Note on Horizontal Scaling* on page 2-184.

Measurement Modes TIMSSOURCE

Examples :DISPlay:SSource:SVIew:X:SCALe:STOP 1MHz
sets the maximum horizontal value to 1 MHz in the subview displaying noisogram.

Related Commands :DISPlay:SSource:SVIew:FORMat

:DISPlay:SSource:SVIew:Y[:SCALe]:FIT (No Query Form)

Runs auto-scale on the subview during the signal source analysis.
The auto-scale automatically sets the start value and scale of the vertical axis to fit the waveform to the screen.

Syntax :DISPlay:SSource:SVIew:Y[:SCALe]:FIT

Arguments None

Measurement Modes TIMSSOURCE

Examples :DISPlay:SSource:SVIew:Y:SCALe:FIT
runs the auto-scale on the subview.

Related Commands :DISPlay:SSource:SVIew:FORMat

:DISPlay:SSource:SVIew:Y[:SCALe]:FULL (No Query Form)

Sets the vertical axis in the subview to the default full-scale value during the signal source analysis.

Syntax :DISPlay:SSource:SVIew:Y[:SCALe]:FULL

Arguments None

Measurement Modes TIMSSOURCE

Examples :DISPlay:SSource:SVIew:Y:SCALe:FULL
sets the subview's vertical axis to the default full-scale value.

Related Commands :DISPlay:SSource:SVIew:FORMat

:DISPlay:SSource:SVIew:Y[:SCALe]:OFFSet(?)

Sets or queries the minimum vertical value (bottom) in the subview during the signal source analysis.

Syntax :DISPlay:SSource:SVIew:Y[:SCALe]:OFFSet <value>
:DISPlay:SSource:SVIew:Y[:SCALe]:OFFSet?

Arguments <value>::=<NRf> specifies the minimum vertical value in the subview. The valid range depends on the display format. Refer to Table D-4 in *Appendix D*.

Measurement Modes TIMSSOURCE

Examples :DISPlay:SSource:SVIew:Y:SCALe:OFFSet -100
sets the minimum vertical value to -100 dBm in the subview displaying spectrum.

Related Commands :DISPlay:SSource:SVIew:FORMat

:DISPlay:SSource:SVIew:Y[:SCALe]:PDIVision(?)

Sets or queries the vertical scale (per division) in the time domain display.

This command is valid when :DISPlay:SSource:SVIew:FORMat is set to SPECtrum, RJVTime, IPNVtime, CNVTime, or CNVFrequency.

Syntax :DISPlay:SSource:SVIew:Y[:SCALe]:PDIVision <value>
:DISPlay:SSource:SVIew:Y[:SCALe]:PDIVision?

Arguments <value>::=<NRf> specifies the vertical scale. The valid range depends on the display format. Refer to Table D-4 in *Appendix D*.

Measurement Modes TIMSSOURCE

Examples :DISPlay:SSource:SVIew:Y:SCALe:PDIVision 15
sets the vertical scale to 15 dB/div in the subview displaying C/N versus time.

Related Commands :DISPlay:SSource:SVIew:FORMat

:DISPlay:SSource:SVIew:Y[:SCALe]:PLINe(?)

Sets or queries the vertical scale (the number of frames per line) in the subview displaying a noisogram. Frames are thinned out from all the acquired framed data at intervals of the number of frames specified in this command, before the noisogram is displayed. For example, if you set the argument to 5, the data will be displayed every 5 frames.

This command is valid when :DISPlay:SSource:SVIew:FORMat is set to NGRam.

Syntax :DISPlay:SSource:SVIew:Y[:SCALe]:PLINe <value>
 :DISPlay:SSource:SVIew:Y[:SCALe]:PLINe?

Arguments <value> ::= <NR1> specifies the vertical scale for the noisogram.
 Range: 1 to 1024 frames per line.

Measurement Modes TIMSSOURCE

Examples :DISPlay:OVIEw:SGRam:Y:SCALe:PLINe 5
 displays the data in the noisogram every 5 frames.

Related Commands :DISPlay:SSource:SVIew:FORMat

:DISPlay:SSource:SVIew:Y[:SCALe]:RANGe(?)

Sets or queries full-scale value of the vertical axis in the subview during the signal source analysis.

This command is valid when :DISPlay:SSource:SVIew:FORMat is set to SPECtrum, RJVTime, IPNVtime, CNVTime, or CNVFrequency.

Syntax :DISPlay:SSource:SVIew:Y[:SCALe]:RANGe <value>
:DISPlay:SSource:SVIew:Y[:SCALe]:RANGe?

Arguments <value>: :=<NRf> specifies full-scale value of the vertical axis in the subview. The valid range depends on the display format. Refer to Table D-4 in *Appendix D*.

Measurement Modes TIMSSOURCE

Examples :DISPlay:SSource:SVIew:Y:SCALe:RANGe 100
sets full-scale value of the vertical axis to 100 dB when the the subview displays the spectrum.

Related Commands :DISPlay:SSource:SVIew:FORMat

:DISPlay:SSource:SPECTrum Subgroup**Signal Source Analysis, Option 21 Only**

The :DISPlay:SSource:SPECTrum commands control the spectrum display in the signal source analysis. This command group is valid in the following measurements:

- Spurious
- Real-time spurious

NOTE. To use a command from this group, you must have selected TIMSSOURCE (signal source analysis) in the :INSTRument[:SElect] command.

The :DISPLay:SSource:SPECTrum commands are valid when [:SENSE]:SSource:MEASurement is set to SPURious (spurious) or RTSPurious (real-time spurious).

Command Tree	Header	Parameter
	:DISPlay	
	:SSource	
	:SPECTrum	
	:X	
	[:SCALE]	
	:OFFSet	<frequency>
	:PDIVision	<frequency>
	:Y	
	[:SCALE]	
	:FIT	
	:FULL	
	:OFFSet	<amplitude>
	:PDIVision	<amplitude>

:DISPlay:SSource:SPECTrum:X[:SCALe]:OFFSet(?)

Sets or queries the minimum horizontal, or frequency, value (left edge) in the spectrum view.

Syntax :DISPlay:SSource:SPECTrum:X[:SCALe]:OFFSet <freq>
:DISPlay:SSource:SPECTrum:X[:SCALe]:OFFSet?

Arguments <freq>::=<NRf> specifies the minimum horizontal value in the spectrum view. For the setting range, refer to *Note on Horizontal Scaling* on page 2-184.

Measurement Modes TIMSSOURCE

Examples :DISPlay:SSource:SPECTrum:X:SCALe:OFFSet 100MHz
sets the minimum horizontal value to 100 MHz.

:DISPlay:SSource:SPECTrum:X[:SCALe]:PDIVision(?)

Sets or queries the horizontal, or frequency, scale (per division) in the spectrum view.

Syntax :DISPlay:SSource:SPECTrum:X[:SCALe]:PDIVision <freq>
:DISPlay:SSource:SPECTrum:X[:SCALe]:PDIVision?

Arguments <freq>::=<NRf> specifies the horizontal scale (per division). For the setting range, refer to *Note on Horizontal Scaling* on page 2-184.

Measurement Modes TIMSSOURCE

Examples :DISPlay:SSource:SPECTrum:X:SCALe:PDIVision 100.0E+3
sets the horizontal scale to 100 kHz/div.

:DISPlay:SSource:SPECTrum:Y[:SCALe]:FIT (No Query Form)

Runs auto-scale on the spectrum view.
The auto-scale automatically sets the start value and scale of the vertical axis to fit the waveform to the screen.

Syntax :DISPlay:SSource:SPECTrum:Y[:SCALe]:FIT

Arguments None

Measurement Modes TIMSSOURCE

Examples :DISPlay:SSource:SPECTrum:Y:SCALe:FIT
runs the auto-scale on the spectrum view.

:DISPlay:SSource:SPECTrum:Y[:SCALe]:FULL (No Query Form)

Sets the vertical axis to the default full-scale value in the spectrum view.

Syntax :DISPlay:SSource:SPECTrum:Y[:SCALe]:FULL

Arguments None

Measurement Modes TIMSSOURCE

Examples :DISPlay:SSource:SPECTrum:Y:SCALe:FULL
sets the vertical axis to the default full-scale value in the spectrum view.

:DISPlay:SSource:SPECTrum:Y[:SCALe]:OFFSet(?)

Sets or queries the minimum vertical, or amplitude, value (bottom) in the spectrum view.

Syntax :DISPlay:SSource:SPECTrum:Y[:SCALe]:OFFSet <ampl>

:DISPlay:SSource:SPECTrum:Y[:SCALe]:OFFSet?

Arguments <ampl>: :=<NRf> sets the minimum vertical value. Range: -200 to 0 dBm.

Measurement Modes TIMSSOURCE

Examples :DISPlay:SSource:SPECTrum:Y:SCALe:OFFSet -100
sets the minimum vertical value to -100 dBm.

:DISPlay:SSource:SPECTrum:Y[:SCALe]:PDIVision(?)

Sets or queries the vertical, or amplitude, scale (per division) in the spectrum view.

Syntax :DISPlay:SSource:SPECTrum:Y[:SCALe]:PDIVision <ampl>

:DISPlay:SSource:SPECTrum:Y[:SCALe]:PDIVision?

Arguments <ampl>: :=<NRf> specifies the vertical scale in the spectrum view.
Range: 0 to 10 dB/div.

Measurement Modes TIMSSOURCE

Examples :DISPlay:SSource:SPECTrum:Y:SCALe:PDIVision 10
sets the vertical scale to 10 dB/div.

:DISPlay:SSource:TFRrequency Subgroup

Signal Source Analysis, Option 21 Only

The :DISPlay:SSource:TFRrequency commands control a three-dimensional view (noisogram) in the signal source analysis.

NOTE. To use a command from this group, you must have selected *TIMS-SOURCE* (signal source analysis) in the :INSTrument[:SELEct] command.

These commands are valid when :DISPlay:SSource:SVIEW:FORMat is set to *NGRAM* (noisogram).

Command Tree	Header	Parameter
	:DISPlay	
	:SSource	
	:TFRrequency	
	:NGRAM	
	:COLor	
	[:SCALE]	
	:OFFSet	<numeric_value>
	:RANge	<numeric_value>
	:X	
	[:SCALE]	
	:STARt	<frequency>
	:STOP	<frequency>
	:Y	
	[:SCALE]	
	:OFFSet	<frame_count>
	:PLINe	<frame_count>

:DISPlay:SSource:TFrequency:NGRam:COLor[:SCALe]:OFFSet(?)

Sets or queries the minimum value (bottom) of the color axis (C/N) in the noisogram.

Syntax :DISPlay:SSource:TFrequency:NGRam:COLor[:SCALe]:OFFSet <value>
:DISPlay:SSource:TFrequency:NGRam:COLor[:SCALe]:OFFSet?

Arguments <amp1>::=<NRf> specifies the minimum color-axis value.
Range: -230 to 70 dBc/Hz.

Measurement Modes TIMSSOURCE

Examples :DISPlay:SSource:TFrequency:NGRam:COLor:SCALe:OFFSet -50
sets the minimum color-axis value to -50 dBc/Hz.

:DISPlay:SSource:TFrequency:NGRam:COLor[:SCALe]:RANGe(?)

Sets or queries full-scale value of the color, or amplitude, axis in the noisogram.

Syntax :DISPlay:SSource:TFrequency:NGRam:COLor[:SCALe]:RANGe <rel_amp1>
:DISPlay:SSource:TFrequency:NGRam:COLor[:SCALe]:RANGe?

Arguments <rel_amp1>::={ 10 | 20 | 50 | 100 } [dBc/Hz] specifies full-scale value of the color axis.

Measurement Modes TIMSSOURCE

Examples :DISPlay:SSource:TFrequency:NGRam:COLor:SCALe:RANGe 100
sets full-scale value of the color axis to 100 dBc/Hz.

:DISPlay:SSource:TFrequency:NGRam:X[:SCALe]:START(?)

Sets or queries the minimum horizontal value (left edge) in the noisogram.

Syntax :DISPlay:SSource:TFrequency:NGRam:X[:SCALe]:START <freq>
 :DISPlay:SSource:TFrequency:NGRam:X[:SCALe]:START?

Arguments <freq> ::= <Nrf> specifies the minimum horizontal value in the noisogram.
 Range: 10 Hz to 100 MHz.
 Refer to *Note on Horizontal Scaling* on page 2-184 for setting the scale.

Measurement Modes TIMSSOURCE

Examples :DISPlay:SSource:TFrequency:NGRam:X:SCALe:START 1kHz
 sets the minimum horizontal value to 1 kHz.

:DISPlay:SSource:TFrequency:NGRam:X[:SCALe]:STOP(?)

Sets or queries the maximum horizontal value (right edge) in the noisogram.

Syntax :DISPlay:SSource:TFrequency:NGRam:X[:SCALe]:STOP <freq>
 :DISPlay:SSource:TFrequency:NGRam:X[:SCALe]:STOP?

Arguments <freq> ::= <Nrf> specifies the maximum horizontal value in the noisogram.
 Range: 10 Hz to 100 MHz.
 Refer to *Note on Horizontal Scaling* on page 2-184 for setting the scale.

Measurement Modes TIMSSOURCE

Examples :DISPlay:SSource:TFrequency:NGRam:X:SCALe:STOP 1MHz
 sets the maximum horizontal value to 1 MHz.

:DISPlay:SSource:TFRrequency:NGRam:Y[:SCALe]:OFFSet(?)

Sets or queries the minimum horizontal, or frame number, value (bottom) in the noisogram.

Syntax :DISPlay:SSource:TFRrequency:NGRam:Y[:SCALe]:OFFSet <value>
:DISPlay:SSource:TFRrequency:NGRam:Y[:SCALe]:OFFSet?

Arguments <value>::=<NR1> specifies the minimum vertical value in the noisogram.
Range: Frame # -40960 to 0.

Measurement Modes TIMSSOURCE

Examples :DISPlay:SSource:TFRrequency:NGRam:Y:SCALe:OFFSet -100
sets the minimum vertical value to frame # -100.

:DISPlay:SSource:TFRrequency:NGRam:Y[:SCALe]:PLINe(?)

Sets or queries the vertical scale (the number of frames per line) in the noisogram. Frames are thinned out from all the acquired framed data at intervals of the number of frames specified in this command, before the noisogram is displayed. For example, if you set the argument to 5, the data will be displayed every 5 frames.

Syntax :DISPlay:SSource:TFRrequency:NGRam:Y[:SCALe]:PLINe <value>
:DISPlay:SSource:TFRrequency:NGRam:Y[:SCALe]:PLINe?

Arguments <value>::=<NR1> specifies the vertical scale in the noisogram.
Range: 1 to 1024 frames per line.

Measurement Modes TIMSSOURCE

Examples :DISPlay:SSource:TFRrequency:NGRam:Y:SCALe:PLINe 5
displays the data in the noisogram every 5 frames.

:DISPlay:SSource:WAVeform Subgroup

Signal Source Analysis, Option 21 Only

The :DISPlay:SSource:WAVeform commands control the time domain display in the signal source analysis. This command group is valid in the frequency versus time measurement only.

NOTE. To use a command from this group, you must have selected TIMSSOURCE (signal source analysis) in the :INSTrument[:SElect] command.

The :DISPLay:SSource:WAVeform commands are valid when [:SENSe]:SSource:MEASurement is set to FVTime (Frequency versus Time).

Command Tree	Header	Parameter
	:DISPLay	
	:SSource	
	:WAVeform	
	:X	
	[:SCALE]	
	:OFFSet	<time>
	:PDIVsion	<time>
	:Y	
	[:SCALE]	
	:FIT	
	:FULL	
	:OFFSet	<numeric_value>
	:PDIVsion	<numeric_value>

:DISPlay:SSource:WAVeform:X[:SCALe]:OFFSet(?)

Sets or queries the minimum value of the horizontal axis (left edge) in the time domain display.

Syntax :DISPlay:SSource:WAVeform:X[:SCALe]:OFFSet <time>
:DISPlay:SSource:WAVeform:X[:SCALe]:OFFSet?

Arguments <time>::=<NRf> sets the minimum horizontal value.
For the setting range, refer to *Note on Horizontal Scaling* on page 2-184.

Measurement Modes TIMSSOURCE

Examples :DISPlay:SSource:WAVeform:X:SCALe:OFFSet -100ms
sets the minimum horizontal value to -100 ms.

:DISPlay:SSource:WAVeform:X[:SCALe]:PDIVision(?)

Sets or queries the horizontal, or time, scale (per division) in the time domain display.

Syntax :DISPlay:SSource:WAVeform:X[:SCALe]:PDIVision <time>
:DISPlay:SSource:WAVeform:X[:SCALe]:PDIVision?

Arguments <time>::=<NRf> specifies the horizontal scale.
For the setting range, refer to *Note on Horizontal Scaling* on page 2-184.

Measurement Modes TIMSSOURCE

Examples :DISPlay:SSource:WAVeform:X:SCALe:PDIVision 10ms
sets the horizontal scale to 10 ms/div.

:DISPlay:SSource:WAVeform:Y[:SCALe]:FIT (No Query Form)

Runs auto-scale on the time domain display. The auto-scale automatically sets the start value and scale of the vertical axis to fit the waveform to the screen.

Syntax :DISPlay:SSource:WAVeform:Y[:SCALe]:FIT

Arguments None

Measurement Modes TIMSSOURCE

Examples :DISPlay:SSource:WAVeform:Y:SCALe:FIT
runs the auto-scale.

:DISPlay:SSource:WAVeform:Y[:SCALe]:FULL (No Query Form)

Sets the vertical axis to the default full-scale value in the time domain display.

Syntax :DISPlay:SSource:WAVeform:Y[:SCALe]:FULL

Arguments None

Measurement Modes TIMSSOURCE

Examples :DISPlay:SSource:WAVeform:Y:SCALe:FULL
sets the vertical axis in the time domain display to the default full-scale value.

:DISPlay:SSource:WAVeform:Y[:SCALe]:OFFSet(?)

Sets or queries the minimum value (bottom) of the vertical axis in the time domain display.

Syntax :DISPlay:SSource:WAVeform:Y[:SCALe]:OFFSet <amp1>

:DISPlay:SSource:WAVeform:Y[:SCALe]:OFFSet?

Arguments <amp1>::=<NRf> specifies the minimum value of the vertical axis. For the setting range, refer to Table D-4 in *Appendix D*.

Measurement Modes TIMSSOURCE

Examples :DISPlay:SSource:WAVeform:Y:SCALe:OFFSet -100kHz
sets the minimum vertical value to -100 kHz in the frequency vs. time view.

:DISPlay:SSource:WAVeform:Y[:SCALe]:PDIVision(?)

Sets the vertical axis scale (per division) in the time domain display.

Syntax :DISPlay:SSource:WAVeform:Y[:SCALe]:PDIVision <amp1>

:DISPlay:SSource:WAVeform:Y[:SCALe]:PDIVision?

Arguments <amp1>::=<NRf> specifies the vertical scale. For the setting range, refer to Table D-4 in *Appendix D*.

Measurement Modes TIMSSOURCE

Examples :DISPlay:SSource:WAVeform:Y:SCALe:PDIVision 50kHz
sets the vertical scale to 50 kHz/div in the frequency vs. time view.

:DISPlay:AC3Gpp Subgroup

W-CDMA, Option 23 Only

The :DISPlay:AC3Gpp commands control display of the W-CDMA ACLR (Adjacent Channel Leakage Power Ratio) measurement.

NOTE. To use a command in this group, you must have selected SAUL3G (W-CDMA uplink spectrum analysis) in the :INSTRument[:SElect] command.

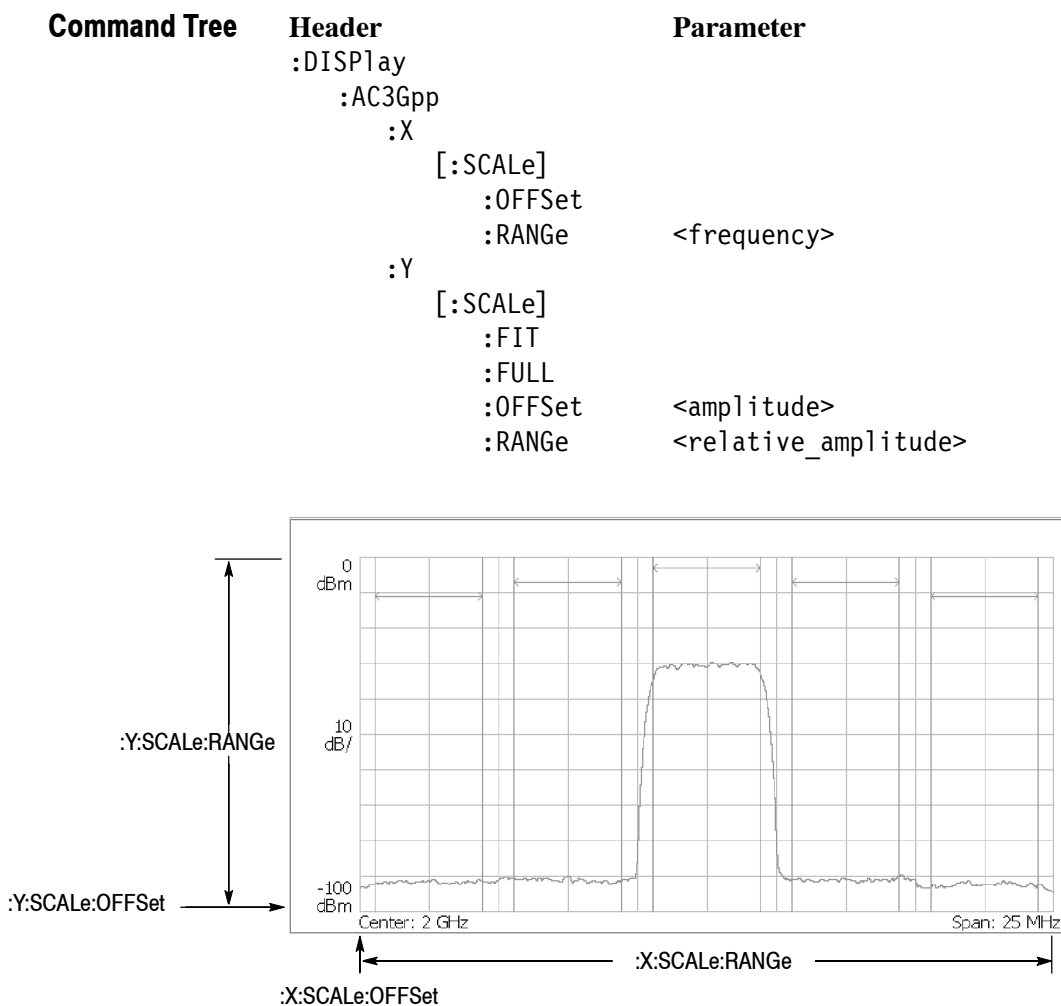

NOTE. Command header :DISPlay:AC3Gpp is omitted here.

Figure 2- 16: :DISPlay:AC3Gpp command setting

:DISPlay:AC3Gpp:X[:SCALE]:OFFSet(?)

Sets or queries the minimum horizontal value (left edge) in the W-CDMA ACLR analysis.

Syntax :DISPlay:AC3Gpp:X[:SCALE]:OFFSet <value>

:DISPlay:AC3Gpp:X[:SCALE]:OFFSet?

Arguments <value>::=<Nrf> specifies the minimum value of the horizontal axis.
Range: Center frequency \pm 25 MHz.
Refer to *Note on Horizontal Scaling* on page 2-184 for setting the scale.

Measurement Modes SAUL3G

Examples :DISPlay:AC3Gpp:X:SCALE:OFFSet 1GHz
sets the minimum value of the horizontal axis to 1 GHz.

:DISPlay:AC3Gpp:X[:SCALE]:RANGe(?)

Sets or queries the full-scale value of the horizontal, or frequency, axis in the W-CDMA ACLR analysis.

Syntax :DISPlay:AC3Gpp:X[:SCALE]:RANGe <value>

:DISPlay:AC3Gpp:X[:SCALE]:RANGe?

Arguments <value>::=<Nrf> specifies the full-scale value of the horizontal axis.
Range: 0 to 25 MHz.
Refer to *Note on Horizontal Scaling* on page 2-184 for setting the scale.

Measurement Modes SAUL3G

Examples :DISPlay:AC3Gpp:X:SCALE:RANGe 25MHz
sets the full-scale value of the horizontal axis to 25 MHz.

:DISPlay:AC3Gpp:Y[:SCALe]:FIT (No Query Form)

Runs auto-scale in the W-CDMA ACLR analysis. The auto-scale automatically sets the start value and scale of the vertical axis to fit the waveform to the screen.

Syntax :DISPlay:AC3Gpp:Y[:SCALe]:FIT

Arguments None

Measurement Modes SAUL3G

Examples :DISPlay:AC3Gpp:Y:SCALe:FIT
runs auto-scale on the main view.

:DISPlay:AC3Gpp:Y[:SCALe]:FULL (No Query Form)

Sets the vertical axis to the default full-scale value in the W-CDMA ACLR analysis.

Syntax :DISPlay:AC3Gpp:Y[:SCALe]:FULL

Arguments None

Measurement Modes SAUL3G

Examples :DISPlay:AC3Gpp:Y:SCALe:FULL
sets the vertical axis to the default full-scale value.

:DISPlay:AC3Gpp:Y[:SCALe]:OFFSet(?)

Queries the minimum vertical value (bottom) in the W-CDMA ACLR analysis.

Syntax :DISPlay:AC3Gpp:Y[:SCALe]:OFFSet <value>

Arguments <value>::=<NRf> sets the minimum vertical value. Range: -200 to +100 dBm.

Measurement Modes SAUL3G

Examples :DISPlay:AC3Gpp:Y:SCALe:OFFSet -100
sets the minimum vertical value to -100 dBm.

:DISPlay:AC3Gpp:Y[:SCALe]:RANGe(?)

Sets or queries the full-scale value of the vertical, or amplitude, axis in the W-CDMA ACLR analysis.

Syntax :DISPlay:AC3Gpp:Y[:SCALe]:RANGe <value>
:DISPlay:AC3Gpp:Y[:SCALe]:RANGe?

Arguments <value>::=<NRf> sets the full-scale value of the vertical axis.
Range: 0 to 100 dBm

Measurement Modes SAUL3G

Examples :DISPlay:AC3Gpp:Y:SCALe:RANGe 100
sets the full-scale value of the vertical axis to 100 dBm.

:DISPlay:UL3Gpp Subgroup**W-CDMA, Option 23 Only**

The :DISPlay:UL3Gpp commands control display of the W-CDMA uplink analysis.

NOTE. To use a command from this group, you must have selected DEMUL3G (W-CDMA uplink modulation analysis) in the :INSTRument[:SElect] command.

Command Tree	Header	Parameter
	:DISPlay	
	:UL3Gpp	
	:AView	
	:SHORTcode	<number>
	:SRATE	R960S R480S R240S R120S R60S R30S R15S
	:TSlot	<number>
	:MView	
	:COLor	
	[:SCALE]	
	:OFFSet	<amplitude>
	:RANge	<relative_amplitude>
	:FORMat	OFF CSGRam CPSHortcode CPSYmbol CPTSlot SCONste SVECTOR SEVM SMERror SPERror SIEYe SQEYe STEYe STABLE CONSte VECTOR
	:RADix	BINary OCTal HEXadecimal
	:X	
	[:SCALE]	
	:OFFSet	<numeric_value>
	:RANge	<numeric_value>
	:Y	
	[:SCALE]	
	:FIT	
	:FULL	
	:OFFSet	<numeric_value>
	:PUNit	RELative ABSolute
	:RANge	<numeric_value>
	:SView	
	:COLor	
	[:SCALE]	
	:OFFSet	<amplitude>
	:RANge	<relative_amplitude>

```

:FORMat      CSGRam | CPSHortcode | CPSYmbol
              | CPTSlot | SCONste | SVECTor | SEVM
              | SMERror | SPERror | SIEYe | SQEYe
              | STEYe | STABle | CONStE | VECTor
              | SPECTrum
:RADix      BINary | OCTal | HEXadecimal
:X
  [:SCALE]
  :OFFSet   <numeric_value>
  :RANGe    <numeric_value>
:Y
  [:SCALE]
  :FIT
  :FULL
  :OFFSet   <numeric_value>
  :PUNit    RELative | ABSolute
  :RANGe    <numeric_value>

```

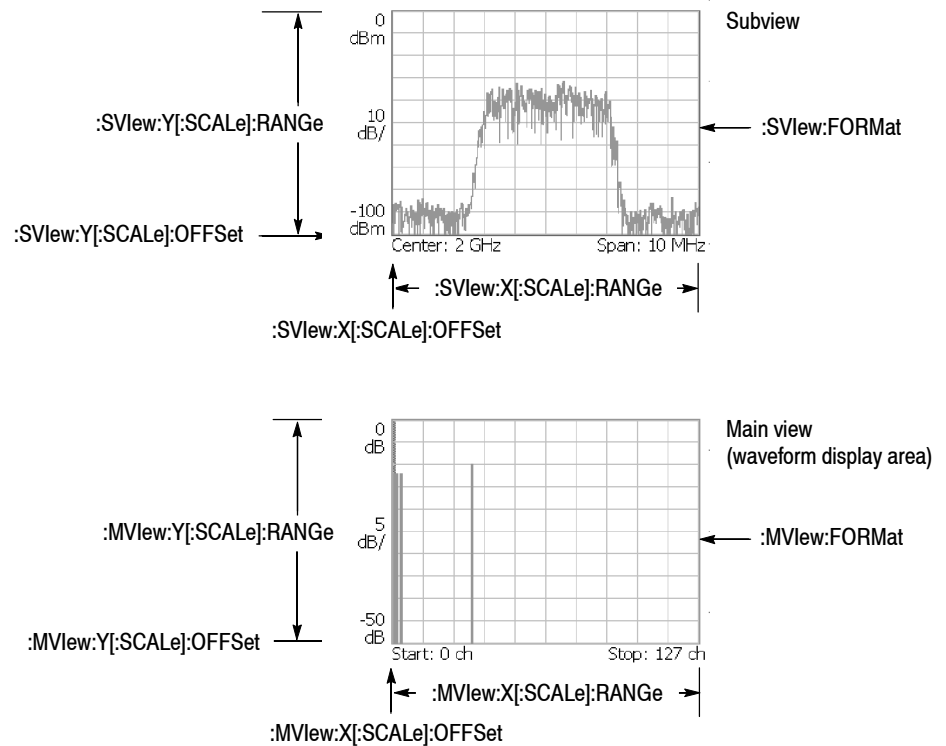

NOTE: Command header :DISPlay:UL3Gpp is omitted here.

Figure 2-17: :DISPlay:UL3Gpp command setting

:DISPlay:UL3Gpp:AVIew:SHORtcode(?)

Sets or queries the short code to be displayed in the W-CDMA uplink analysis.

Syntax :DISPlay:UL3Gpp:AVIew:SHORtcode <number>

:DISPlay:UL3Gpp:AVIew:SHORtcode?

Arguments <number>: :=<NR1> specifies the short code to be displayed.
Range: channel 0 to 511.

Measurement Modes DEMUL3G

Examples :DISPlay:UL3Gpp:AVIew:SHORtcode 100
sets the short code to channel 100.

:DISPlay:UL3Gpp:AVIew:SRATe(?)

Selects or queries the symbol rate for the measurement in the W-CDMA uplink analysis.

Syntax :DISPlay:UL3Gpp:AVIew:SRATe { R960S | R480S | R240S | R120S
| R60S | R30S | R15S }
:DISPlay:UL3Gpp:AVIew:SRATe?

Arguments The arguments specify the symbol rates listed below:

Table 2-44: Symbol rate settings

Argument	Symbol rate
R960S	960k
R480S	480k
R240S	240k
R120S	120k
R60S	60k
R30S	30k
R15S	15k

NOTE. The arguments of R960S, R480S, and R240S are not available for the signal type of PRACH (refer to the [:SENSe]:UL3Gpp:MMODE command on page 2-1202).

Measurement Modes DEMUL3G

Examples :DISPlay:UL3Gpp:AVIew:SRATe R960S
sets the symbol rate to 960 k.

Related Commands [:SENSe]:UL3Gpp:MMODE

:DISPlay:UL3Gpp:AVIew:TSLot(?)

Sets or queries the number of the time slot to be displayed in the W-CDMA uplink analysis.

Syntax :DISPlay:UL3Gpp:AVIew:TSLot <number>

 :DISPlay:UL3Gpp:AVIew:TSLot?

Arguments <number>::=<NRf> specifies the number of the time slot to be displayed.
Range: Slot # -15999 to 0.

Measurement Modes DEMUL3G

Examples :DISPlay:UL3Gpp:AVIew:TSLot -100
 specifies the time slot # -100 is displayed.

:DISPlay:UL3Gpp:MView:COLor[:SCALe]:OFFSet(?)

Sets or queries the minimum value of the color, or amplitude, axis when the main view displays a spectrogram in the W-CDMA uplink analysis.

Syntax :DISPlay:UL3Gpp:MView:COLor[:SCALe]:OFFSet <value>

:DISPlay:UL3Gpp:MView:COLor[:SCALe]:OFFSet?

Arguments <value>::=<NRf> specifies the minimum color-axis value of the spectrogram.
Range: -200 to +100 dBm.

Measurement Modes DEMUL3G

Examples :DISPlay:UL3Gpp:MView:COLor:SCALe:OFFSet -100
sets the minimum color-axis value in the main view to -100 dBm.

:DISPlay:UL3Gpp:MView:COLor[:SCALe]:RANGe(?)

Sets or queries full-scale value of the color, or amplitude, axis when the main view displays a spectrogram in the W-CDMA uplink analysis.

Syntax :DISPlay:UL3Gpp:MView:COLor[:SCALe]:RANGe <value>

:DISPlay:UL3Gpp:MView:COLor[:SCALe]:RANGe?

Arguments <value>::={ 10 | 20 | 50 | 100 } [dB] specifies full-scale value of the color axis of the spectrogram.

Measurement Modes DEMUL3G

Examples :DISPlay:UL3Gpp:MView:COLor:SCALe:RANGe 100
sets full-scale value of the color axis in the main view to 100 dB.

:DISPlay:UL3Gpp:MView:FORMat(?)

Sets or queries the main view display format in the W-CDMA uplink analysis.

Syntax :DISPlay:UL3Gpp:MView:FORMat { OFF | CSGRam | CPSHortcode
 | CPSYmbol | CPTSlot | SCONste | SVEctor | SEVM | SMERror
 | SPERror | SIEYe | SQEYe | STEYe | STABLE | CONSte | VECTor }
 :DISPlay:UL3Gpp:MView:FORMat?

Arguments The arguments and display formats are listed below:

Table 2-45: Main view display formats

Argument	Display format
OFF	Hides all measurement results.
CSGRam	Code domain power spectrogram
CPSHortcode	Code domain power vs short code
CPSYmbol	Code domain power versus symbol
CPTSlot	Code domain power versus time slot
SCONste	Symbol constellation
SVEctor	Symbol vector
SEVM	Symbol EVM
SMERror	Symbol amplitude error
SPERror	Symbol phase error
SIEYe	Symbol eye diagram (vertical axis: I)
SQEYe	Symbol eye diagram (vertical axis: Q)
STEYe	Symbol trellis diagram (vertical axis: Phase)
STABLE	Symbol table
CONSte	Constellation and modulation accuracy measurement results
VECTor	Vector locus

Measurement Modes DEMUL3G

Examples :DISPlay:UL3Gpp:MView:FORMat CSGRam
 displays the code domain power spectrogram in the main view.

:DISPlay:UL3Gpp:MView:RADix(?)

Selects or queries the base of symbols on the main view in the W-CDMA uplink analysis.

NOTE. This command is valid when :DISPlay:UL3Gpp:MView:FORMat is set to STABLE (symbol table).

Syntax :DISPlay:UL3Gpp:MView:RADix { BINary | OCTal | HEXadecimal }
:DISPlay:UL3Gpp:MView:RADix?

Arguments BINary selects binary notation.
OCTal selects octal notation.
HEXadecimal selects hexadecimal notation.

Measurement Modes DEMUL3G

Examples :DISPlay:UL3Gpp:MView:RADix BINary
selects binary notation for the base of symbols in the main view.

Related Commands :DISPlay:UL3Gpp:MView:FORMat

:DISPlay:UL3Gpp:MView:X[:SCALe]:OFFSet(?)

Sets or queries the minimum horizontal value (left edge) in the main view during the W-CDMA uplink analysis.

Syntax :DISPlay:UL3Gpp:MView:X[:SCALe]:OFFSet <value>

 :DISPlay:UL3Gpp:MView:X[:SCALe]:OFFSet?

Arguments <value>::=<Nrf> specifies the minimum horizontal value in the main view. Refer to *Note on Horizontal Scaling* on page 2-184 for setting the scale.

Measurement Modes DEMUL3G

Examples :DISPlay:UL3Gpp:MView:X:SCALe:OFFSet 0
sets the minimum horizontal value to channel 0 when the main view displays a code domain power spectrogram.

:DISPlay:UL3Gpp:MView:X[:SCALe]:RANGe(?)

Sets or queries full-scale value of the horizontal axis in the main view during the W-CDMA uplink analysis.

Syntax :DISPlay:UL3Gpp:MView:X[:SCALe]:RANGe <value>

 :DISPlay:UL3Gpp:MView:X[:SCALe]:RANGe?

Arguments <value>::=<Nrf> specifies full-scale value of the horizontal axis in the main view. Refer to *Note on Horizontal Scaling* on page 2-184 for setting the scale.

Measurement Modes DEMUL3G

Examples :DISPlay:UL3Gpp:MView:X:SCALe:RANGe 512
sets the horizontal full-scale value to 512 channels when the main view displays a code domain power spectrogram.

:DISPlay:UL3Gpp:MView:Y[:SCALE]:FIT (No Query Form)

Runs auto-scale on the main view in the W-CDMA uplink analysis. The auto-scale automatically sets the start value and scale of the vertical axis to fit the waveform to the screen.

This command is valid when :DISPlay:UL3Gpp:MView:FORMat is set to CPHortcode, CPSYmbol, CPTSlot, SEVM, SMERror, or SPERror.

Syntax :DISPlay:UL3Gpp:MView:Y[:SCALE]:FIT

Arguments None

Measurement Modes DEMUL3G

Examples :DISPlay:UL3Gpp:MView:Y:SCALE:FIT
runs the auto-scale on the main view.

Related Commands :DISPlay:UL3Gpp:MView:FORMat

:DISPlay:UL3Gpp:MView:Y[:SCALE]:FULL (No Query Form)

Sets the vertical axis in the main view to the default full-scale value during the W-CDMA uplink analysis.

This command is valid when :DISPlay:UL3Gpp:MView:FORMat is set to CPHortcode, CPSYmbol, CPTSlot, SEVM, SMERror, or SPERror.

Syntax :DISPlay:UL3Gpp:MView:Y[:SCALE]:FULL

Arguments None

Measurement Modes DEMUL3G

Examples :DISPlay:UL3Gpp:MView:Y:SCALE:FULL
sets the main view's vertical axis to the default full-scale value.

Related Commands :DISPlay:UL3Gpp:MView:FORMat

:DISPlay:UL3Gpp:MView:Y[:SCALE]:OFFSet(?)

Sets or queries the minimum vertical value (bottom) in the main view during the W-CDMA uplink analysis.

This command is valid when :DISPlay:UL3Gpp:MView:FORMat is set to CSGRam, CPHortcode, CPSYmbol, CPTSlot, SEVM, SMERror, or SPERror.

Syntax :DISPlay:UL3Gpp:MView:Y[:SCALE]:OFFSet <value>
 :DISPlay:UL3Gpp:MView:Y[:SCALE]:OFFSet?

Arguments <value>::=<NRf> specifies the minimum vertical value in the main view. The valid range depends on the display format. Refer to Table D-5 in *Appendix D*.

Measurement Modes DEMUL3G

Examples :DISPlay:UL3Gpp:MView:Y:SCALE:OFFSet 0
 sets the bottom of the vertical axis to slot 0 when the main view displays a code domain power spectrogram.

Related Commands :DISPlay:UL3Gpp:MView:FORMat

:DISPlay:UL3Gpp:MView:Y[:SCALE]:PUnit(?)

Selects or queries the unit on the Y, or power, axis in the main view during the W-CDMA uplink analysis.

This command is valid when :DISPlay:UL3Gpp:MView:FORMat is set to CSGRam, CPSHortcode, CPSYmbol, or CPTSlot.

Syntax :DISPlay:UL3Gpp:MView:Y[:SCALE]:PUnit { RELative | ABSolute }
:DISPlay:UL3Gpp:MView:Y[:SCALE]:PUnit?

Arguments RELative represents along the Y axis, the relative channel power to the total power of all the channels in dB.

ABSolute represents the absolute power of each channel along the Y axis in dBm.

Measurement Modes DEMUL3G

Examples :DISPlay:UL3Gpp:MView:Y:SCALE:PUnit RELative
represents the relative power along the Y axis in the main view.

Related Commands :DISPlay:UL3Gpp:MView:FORMat

:DISPlay:UL3Gpp:MView:Y[:SCALe]:RANGe(?)

Sets or queries the vertical full-scale value in the main view during the W-CDMA uplink analysis.

This command is valid when :DISPlay:UL3Gpp:MView:FORMat is set to CSGRam, CPHortcode, CPSYmbol, CPTSlot, SEVM, SMERror, or SPERror.

Syntax :DISPlay:UL3Gpp:MView:Y[:SCALe]:RANGe <value>
 :DISPlay:UL3Gpp:MView:Y[:SCALe]:RANGe?

Arguments <value>::=<NRf> specifies the vertical full-scale value in the main view. The valid range depends on the display format. Refer to Table D-5 in *Appendix D*.

Measurement Modes DEMUL3G

Examples :DISPlay:UL3Gpp:MView:Y:SCALe:RANGe 50
 sets the vertical full-scale value to 50 slots when the main view displays a code domain power spectrogram.

Related Commands :DISPlay:UL3Gpp:MView:FORMat

:DISPlay:UL3Gpp:SVIew:COLor[:SCALE]:OFFSet(?)

Sets or queries the minimum value of the color, or amplitude, axis when the subview displays a spectrogram in the W-CDMA uplink analysis.

Syntax :DISPlay:UL3Gpp:SVIew:COLor[:SCALE]:OFFSet <value>
:DISPlay:UL3Gpp:SVIew:COLor[:SCALE]:OFFSet?

Arguments <value>::=<NRf> specifies the minimum color-axis value.
Range: -200 to +100 dBm.

Measurement Modes DEMUL3G

Examples :DISPlay:UL3Gpp:SVIew:COLor:SCALE:OFFSet -100
sets the minimum color-axis value in the subview to -100 dBm.

:DISPlay:UL3Gpp:SVIew:COLor[:SCALE]:RANGe(?)

Sets or queries full-scale value of the color axis when the subview displays a spectrogram in the W-CDMA uplink analysis.

Syntax :DISPlay:UL3Gpp:SVIew:COLor[:SCALE]:RANGe <value>
:DISPlay:UL3Gpp:SVIew:COLor[:SCALE]:RANGe?

Arguments <value>::={ 10 | 20 | 50 | 100 } [dB] specifies full-scale value of the color axis.

Measurement Modes DEMUL3G

Examples :DISPlay:UL3Gpp:SVIew:COLor:SCALE:RANGe 100
sets full-scale value of the subview's color axis to 100 dB.

:DISPlay:UL3Gpp:SVIew:FORMat(?)

Sets or queries the subview display format in the W-CDMA uplink analysis.

Syntax :DISPlay:UL3Gpp:SVIew:FORMat { CSGRam | CPSHortcode | CPSYmbol
| CPTSlot | SCONste | SVECTor | SEVM | SMERror | SPERror | SIEYe
| SQEYe | STEYe | STABLe | CONSte | VECTor | SPECTrum }
:DISPlay:UL3Gpp:SVIew:FORMat?

Arguments The arguments and display formats are listed below:

Table 2-46: Subview display formats

Argument	Display format
CSGRam	Code domain power spectrogram
CPSHortcode	Code domain power versus short code
CPSYmbol	Code domain power versus symbol
CPTSlot	Code domain power versus time slot
SCONste	Symbol constellation
SVECTor	Symbol vector
SEVM	Symbol EVM
SMERror	Symbol amplitude error
SPERror	Symbol phase error
SIEYe	Symbol eye diagram (vertical axis: I)
SQEYe	Symbol eye diagram (vertical axis: Q)
STEYe	Symbol trellis diagram (vertical axis: Phase)
STABLe	Symbol table
CONSte	Constellation
VECTor	Vector locus
SPECTrum	Spectrum

Measurement Modes DEMUL3G

Examples :DISPlay:UL3Gpp:SVIew:FORMat CSGRam
displays the code domain power spectrogram in the subview.

Related Commands :DISPlay:UL3Gpp:MVIew:FORMat

:DISPlay:UL3Gpp:SVIew:RADix(?)

Selects or queries the base of symbols in the subview during the W-CDMA uplink analysis.

NOTE. This command is valid when `:DISPlay:UL3Gpp:SVIew:FORMat` is set to `STABle` (symbol table).

Syntax `:DISPlay:UL3Gpp:SVIew:RADix { BINary | OCTal | HEXadecimal }`
 `:DISPlay:UL3Gpp:SVIew:RADix?`

Arguments `BINary` selects binary notation.
 `OCTal` selects octal notation.
 `HEXadecimal` selects hexadecimal notation.

Measurement Modes `DEMUL3G`

Examples `:DISPlay:UL3Gpp:SVIew:RADix BINary`
 selects the binary notation for the base of symbols in the subview.

Related Commands `:DISPlay:UL3Gpp:SVIew:FORMat`

:DISPlay:UL3Gpp:SVIew:X[:SCALe]:OFFSet(?)

Sets or queries the minimum horizontal value (left edge) in the subview during the W-CDMA uplink analysis.

Syntax :DISPlay:UL3Gpp:SVIew:X[:SCALe]:OFFSet <value>

 :DISPlay:UL3Gpp:SVIew:X[:SCALe]:OFFSet?

Arguments <value>::=<NRf> specifies the minimum horizontal value in the subview. Refer to *Note on Horizontal Scaling* on page 2-184 for setting the scale.

Measurement Modes DEMUL3G

Examples :DISPlay:UL3Gpp:SVIew:X:SCALe:OFFSet 0
sets the minimum horizontal value to channel 0 when the subview displays a code domain power spectrogram.

:DISPlay:UL3Gpp:SVIew:X[:SCALe]:RANGe(?)

Sets or queries full-scale value of the horizontal axis in the subview during the W-CDMA uplink analysis.

Syntax :DISPlay:UL3Gpp:SVIew:X[:SCALe]:RANGe <value>

 :DISPlay:UL3Gpp:SVIew:X[:SCALe]:RANGe?

Arguments <value>::=<NRf> specifies full-scale value of the horizontal axis in the subview. Refer to *Note on Horizontal Scaling* on page 2-184 for setting the scale.

Measurement Modes DEMUL3G

Examples :DISPlay:UL3Gpp:SVIew:X:SCALe:RANGe 512
sets full-scale value of the horizontal axis to 512 channels when the subview displays a code domain power spectrogram.

:DISPlay:UL3Gpp:SVIew:Y[:SCALE]:FIT (No Query Form)

Runs auto-scale on the subview in the W-CDMA uplink analysis. The auto-scale automatically sets the start value and scale of the vertical axis to fit the waveform to the screen.

This command is valid when :DISPlay:UL3Gpp:SVIew:FORMat is set to CPHortcode, CPSYmbol, CPTSlot, SEVM, SMERror, or SPERror.

Syntax :DISPlay:UL3Gpp:SVIew:Y[:SCALE]:FIT

Arguments None

Measurement Modes DEMUL3G

Examples :DISPlay:UL3Gpp:SVIew:Y:SCALE:FIT
runs the auto-scale on the subview.

Related Commands :DISPlay:UL3Gpp:SVIew:FORMat

:DISPlay:UL3Gpp:SVIew:Y[:SCALE]:FULL (No Query Form)

Sets the vertical axis in the subview to the default full-scale value during the W-CDMA uplink analysis.

This command is valid when :DISPlay:UL3Gpp:SVIew:FORMat is set to CPHortcode, CPSYmbol, CPTSlot, SEVM, SMERror, or SPERror.

Syntax :DISPlay:UL3Gpp:SVIew:Y[:SCALE]:FULL

Arguments None

Measurement Modes DEMUL3G

Examples :DISPlay:UL3Gpp:SVIew:Y:SCALE:FULL
sets the subview's vertical axis to the default full-scale value.

Related Commands :DISPlay:UL3Gpp:SVIew:FORMat

:DISPlay:UL3Gpp:SVIew:Y[:SCALE]:OFFSet(?)

Sets or queries the minimum vertical value (bottom) in the subview during the W-CDMA uplink analysis.

This command is valid when :DISPlay:UL3Gpp:MVIew:FORMat is set to CSGRam, CPHortcode, CPSYmbol, CPTSlot, SEVM, SMERror, or SPERror.

Syntax :DISPlay:UL3Gpp:SVIew:Y[:SCALE]:OFFSet <value>

:DISPlay:UL3Gpp:SVIew:Y[:SCALE]:OFFSet?

Arguments <value>::=<NRf> specifies the minimum vertical value in the subview. The valid range depends on the display format. Refer to Table D-5 in *Appendix D*.

Measurement Modes DEMUL3G

Examples :DISPlay:UL3Gpp:SVIew:Y:SCALE:OFFSet 0
sets the bottom of the vertical axis to slot 0 when the subview displays a code domain power spectrogram.

Related Commands :DISPlay:UL3Gpp:SVIew:FORMat

:DISPlay:UL3Gpp:SVIew:Y[:SCALe]:PUNit(?)

Selects or queries the unit on the Y, or power, axis in the subview during the W-CDMA uplink analysis.

This command is valid when :DISPlay:UL3Gpp:SVIew:FORMat is set to CSGRam, CPHortcode, CPSYmbol, or CPTSlot.

Syntax :DISPlay:UL3Gpp:SVIew:Y[:SCALe]:PUNit { RELative | ABSolute }
:DISPlay:UL3Gpp:SVIew:Y[:SCALe]:PUNit?

Arguments RELative represents along the Y axis, the relative channel power to the total power of all the channels in dB.
ABSolute represents the absolute power of each channel along the Y axis in dBm.

Measurement Modes DEMUL3G

Examples :DISPlay:UL3Gpp:SVIew:Y:SCALe:PUNit RELative
represents the relative power along the Y axis in the subview.

Related Commands :DISPlay:UL3Gpp:SVIew:FORMat

:DISPlay:UL3Gpp:SVIew:Y[:SCALe]:RANGe(?)

Sets or queries full-scale value of the vertical axis in the subview during the W-CDMA uplink analysis.

This command is valid when :DISPlay:UL3Gpp:SVIew:FORMat is set to CSGRam, CPHortcode, CPSYmbol, CPTSlot, SEVM, SMERror, or SPERror.

Syntax :DISPlay:UL3Gpp:SVIew:Y[:SCALe]:RANGe <value>
 :DISPlay:UL3Gpp:SVIew:Y[:SCALe]:RANGe?

Arguments <value> ::= <NRf> specifies full-scale value of the vertical axis in the subview. The valid range depends on the display format. Refer to Table D-5 in *Appendix D*.

Measurement Modes DEMUL3G

Examples :DISPlay:UL3Gpp:SVIew:Y:SCALe:RANGe 50
 sets full-scale value of the vertical axis to 50 slots when the subview displays a code domain power spectrogram.

Related Commands :DISPlay:UL3Gpp:SVIew:FORMat

:DISPlay:GSMedge:DDEMod Subgroup**GSM/EDGE, Option 24 Only**

The :DISPlay:GSMedge:DDEMod commands control display of the main view and subview for the GSM/EDGE modulation analysis.

NOTE. To use a command from this group, you must have selected DEM-GSMEDGE (GSM/EDGE analysis) in the :INSTrument[:SElect] command.

Command Tree	Header	Parameter
	:DISPlay	
	:GSMedge	
	:DDEMod	
	:MView	
	FILTer	
	:EINVerse	<boolean>
	:FORMat	CONStE VECTor EVM MERRor PERRor OFF
	:STIME	SYMBol ISYMBol
	:X	
	[:SCALE]	
	:OFFSet	<numeric_value>
	:RANGe	<numeric_value>
	:Y	
	[:SCALE]	
	:FIT	
	:FULL	
	:OFFSet	<numeric_value>
	:RANGe	<numeric_value>
	:SVIew	
	FILTer	
	:EINVerse	<boolean>
	:FORMat	IQVTime SPECTrum CONStE VECTor EVM MERRor PERRor IEYE QEYE TEYE STABle
	:STIME	SYMBol ISYMBol
	:X	
	[:SCALE]	
	:OFFSet	<numeric_value>
	:RANGe	<numeric_value>
	:Y	
	[:SCALE]	
	:FIT	
	:FULL	
	:OFFSet	<numeric_value>
	:RANGe	<numeric_value>

:DISPlay:GSMedge:DDEMod:MView:FILTER:EINVerse(?)

Determines whether to enable or disable the inverse filter for the EDGE signal on the main view set to constellation in the GSM/EDGE analysis.

This command is valid when :DISPlay:GSMedge:DDEMod:MView:FORMat is CONSTe and [:SENSe]:GSMedge:MODulation is EDGE.

Syntax :DISPlay:GSMedge:DDEMod:MView:FILTER:EINVerse { OFF | ON | 0
| 1 }

:DISPlay:GSMedge:DDEMod:MView:FILTER:EINVerse?

Arguments OFF or 0 disables the inverse filter for the EDGE signal.

ON or 1 enables the inverse filter for the EDGE signal.

Measurement Modes DEMGSMEDGE

Examples :DISPlay:GSMedge:DDEMod:MView:FILTER:EINVerse ON
enables the inverse filter for the EDGE signal.

Related Commands :DISPlay:GSMedge:DDEMod:MView:FORMat,
[:SENSe]:GSMedge:MODulation

:DISPlay:GSMedge:DDEMod:MView:FORMat(?)

Selects or queries the display format of the main view in the GSM/EDGE analysis.

Syntax :DISPlay:GSMedge:DDEMod:MView:FORMat { CONStE | VECTor | EVM
| MERRor | PERRor | OFF }
:DISPlay:GSMedge:DDEMod:MView:FORMat?

Arguments Table 2-47 shows the arguments and the display formats.

Table 2-47: Main view display formats

Argument	Display format
CONStE	Constellation
VECTor	Vector
EVM	Error vector magnitude (EVM)
MERRor	Magnitude error
PERRor	Phase error
OFF	Hides all measurement results.

Measurement Modes DEMGSMEDGE

Examples :DISPlay:GSMedge:DDEMod:MView:FORMat CONStE
selects constellation for the main view.

Related Commands :DISPlay:GSMedge:DDEMod:SView:FORMat

:DISPlay:GSMedge:DDEMod:MView:STIME(?)

Sets or queries the slice timing on the main view set to constellation in the GSM/EDGE analysis.

This command is valid when :DISPlay:GSMedge:DDEMod:MView:INVerse is OFF, :DISPlay:GSMedge:DDEMod:MView:FORMat is CONSTe and [:SENSe]:GSMedge:MODulation is EDGE.

Syntax :DISPlay:GSMedge:DDEMod:MView:STIME { SYMBol | ISYMBol }

:DISPlay:GSMedge:DDEMod:MView:STIME?

Arguments SYMBol displays a red point at the symbol position.

ISYMBol displays a red point halfway between two symbols.

Measurement Modes DEMGSMEDGE

Examples :DISPlay:GSMedge:DDEMod:MView:STIME SYMBol
displays a red point at the symbol position.

Related Commands :DISPlay:GSMedge:DDEMod:MView:INVerse,
:DISPlay:GSMedge:DDEMod:MView:FORMat,
[:SENSe]:GSMedge:MODulation

:DISPlay:GSMedge:DDEMod:MView:X[:SCALE]:OFFSet(?)

Sets or queries the minimum horizontal value (left edge) in the main view in the GSM/EDGE analysis.

Syntax :DISPlay:GSMedge:DDEMod:MView:X[:SCALE]:OFFSet <value>
:DISPlay:GSMedge:DDEMod:MView:X[:SCALE]:OFFSet?

Arguments <value>::=<NRf> specifies the minimum horizontal value in the main view. Refer to *Note on Horizontal Scaling* on page 2-184 for setting the scale.

Measurement Modes DEMGSMEDGE

Examples :DISPlay:GSMedge:DDEMod:MView:X:SCALE:OFFSet -20ms
sets the minimum horizontal value to -20 ms when the main view displays EVM.

Related Commands :DISPlay:GSMedge:DDEMod:MView:FORMat

:DISPlay:GSMedge:DDEMod:MView:X[:SCALE]:RANGe(?)

Sets or queries the full-scale value of the horizontal axis in the main view in the GSM/EDGE analysis.

Syntax :DISPlay:GSMedge:DDEMod:MView:X[:SCALE]:RANGe <value>
:DISPlay:GSMedge:DDEMod:MView:X[:SCALE]:RANGe?

Arguments <value>::=<NRf> specifies the full-scale value of the horizontal axis in the main view. Refer to *Note on Horizontal Scaling* on page 2-184 for setting the scale.

Measurement Modes DEMGSMEDGE

Examples :DISPlay:GSMedge:DDEMod:MView:X:SCALE:RANGe 50us
sets the full-scale value of the horizontal axis to 50 μ s when the main view displays EVM.

Related Commands :DISPlay:GSMedge:DDEMod:MView:FORMat

:DISPlay:GSMedge:DDEMod:MView:Y[:SCALE]:FIT (No Query Form)

Runs auto-scale on the main view in the GSM/EDGE analysis.

The auto-scale automatically sets the start value and scale of the vertical axis to fit the waveform to the screen.

This command is valid when :DISPlay:GSMedge:DDEMod:MView:FORMat is set to EVM, MERRor, or PERRor.

Syntax :DISPlay:GSMedge:DDEMod:MView:Y[:SCALE]:FIT

Arguments None

Measurement Modes DEMGSMEDGE

Examples :DISPlay:GSMedge:DDEMod:MView:Y:SCALE:FIT
runs the auto-scale on the main view.

Related Commands :DISPlay:GSMedge:DDEMod:MView:FORMat

:DISPlay:GSMedge:DDEMod:MView:Y[:SCALE]:FULL (No Query Form)

Sets the vertical axis in the main view to the default full-scale value in the GSM/EDGE analysis.

This command is valid when :DISPlay:GSMedge:DDEMod:MView:FORMat is set to EVM, MERRor, or PERRor.

Syntax :DISPlay:GSMedge:DDEMod:MView:Y[:SCALE]:FULL

Arguments None

Measurement Modes DEMGSMEDGE

Examples :DISPlay:GSMedge:DDEMod:MView:Y:SCALE:FULL
sets the main view's vertical axis to the default full-scale value.

Related Commands :DISPlay:GSMedge:DDEMod:MView:FORMat

:DISPlay:GSMedge:DDEMod:MView:Y[:SCALE]:OFFSet(?)

Sets or queries the minimum vertical value in the main view (bottom edge) in the GSM/EDGE analysis.

This command is valid when :DISPlay:GSMedge:DDEMod:MView:FORMat is set to EVM, MERRor, or PERRor.

Syntax :DISPlay:GSMedge:DDEMod:MView:Y[:SCALE]:OFFSet <value>
:DISPlay:GSMedge:DDEMod:MView:Y[:SCALE]:OFFSet?

Arguments <value>: :=<NRf> specifies the minimum vertical value in the main view. The valid range depends on the display format. Refer to Table D-1 in *Appendix D*.

Measurement Modes DEMGSMEDGE

Examples :DISPlay:GSMedge:DDEMod:MView:Y:SCALE:OFFSet 10pct
sets the minimum vertical value to 10% when the main view displays EVM.

Related Commands :DISPlay:GSMedge:DDEMod:MView:FORMat

:DISPlay:GSMedge:DDEMod:MView:Y[:SCALE]:RANGe(?)

Sets or queries full-scale value of the vertical axis in the main view in the GSM/EDGE analysis.

This command is valid when :DISPlay:GSMedge:DDEMod:MView:FORMat is set to EVM, MERRor, or PERRor.

Syntax :DISPlay:GSMedge:DDEMod:MView:Y[:SCALE]:RANGe <value>
 :DISPlay:GSMedge:DDEMod:MView:Y[:SCALE]:RANGe?

Arguments <value> ::= <NRf> specifies full-scale value of the vertical axis in the main view. The valid range depends on the display format. Refer to Table D-1 in *Appendix D*.

Measurement Modes DEMGSMEDGE

Examples :DISPlay:GSMedge:DDEMod:MView:Y:SCALE:RANGe 50pct
 sets full-scale value of the vertical axis to 50% when the the main view displays EVM.

Related Commands :DISPlay:GSMedge:DDEMod:MView:FORMat

:DISPlay:GSMedge:DDEMod:SVIew:FILTer:EINVerse(?)

Determines whether to enable or disable the inverse filter for the EDGE signal on the subview set to constellation in the GSM/EDGE analysis.

This command is valid when :DISPlay:GSMedge:DDEMod:SVIew:FORMat is CONStE and [:SENSe]:GSMedge:MODulation is EDGE.

Syntax :DISPlay:GSMedge:DDEMod:SVIew:FILTer:EINVerse { OFF | ON | 0
| 1 }

:DISPlay:GSMedge:DDEMod:SVIew:FILTer:EINVerse?

Arguments OFF or 0 disables the inverse filter for the EDGE signal.

ON or 1 enables the inverse filter for the EDGE signal.

Measurement Modes DEMGSMEDGE

Examples :DISPlay:GSMedge:DDEMod:SVIew:FILTer:EINVerse ON
enables the inverse filter for the EDGE signal in the subview.

Related Commands :DISPlay:GSMedge:DDEMod:SVIew:FORMat,
[:SENSe]:GSMedge:MODulation

:DISPlay:GSMedge:DDEMod:SVIew:FORMat(?)

Selects or queries the display format of the subview in the GSM/EDGE analysis.

This command is valid when the measurement item is modulation accuracy (MACCuracy), mean carrier power (MCPower), modulation spectrum (MODulation), or power versus time (PVTime).

Syntax :DISPlay:GSMedge:DDEMod:SVIew:FORMat { IQVTime | FVTime | CONStE
| VECTor | EVM | MERRor | PERRor | IEYE | QEYE | TEYE | STABle }

:DISPlay:GSMedge:DDEMod:SVIew:FORMat?

Arguments The arguments and display formats are listed below:

Table 2-48: Subview display formats

Argument	Display format
IQVTime	IQ level versus Time
SPECTrum	Spectrum
CONSte	Constellation
VECTor	Vector
EVM	Error vector magnitude (EVM)
MERRor	Amplitude error
PERRor	Phase error
IEYE	Eye diagram (vertical axis: I data)
QEYE	Eye diagram (vertical axis: Q data)
TEYE	Eye diagram (vertical axis: Phase)
STABle	Symbol table

NOTE. The display format is fixed to spectrum when the measurement item is switching spectrum (SWITching).

Measurement Modes DEMGSMEDGE

Examples :DISPlay:GSMedge:DDEMod:SVIew:FORMat CONSte
displays the constellation in the subview.

Related Commands :DISPlay:GSMedge:DDEMod:MVIew:FORMat,
[:SENSe]:GSMedge:MEASurement

:DISPlay:GSMedge:DDEMod:SVIew:STIME(?)

Sets or queries the slice timing on the subview set to constellation in the GSM/EDGE analysis.

This command is valid when :DISPlay:GSMedge:DDEMod:SVIew:EINVerse is OFF, :DISPlay:GSMedge:DDEMod:SVIew:FORMat is CONStE and [:SENSe]:GSMedge:MODulation is EDGE.

Syntax :DISPlay:GSMedge:DDEMod:SVIew:STIME { SYMBo1 | ISYMbo1 }

:DISPlay:GSMedge:DDEMod:SVIew:STIME?

Arguments SYMBo1 displays a red point at the symbol position.

ISYMbo1 displays a red point halfway between two symbols.

Measurement Modes DEMGSMEDGE

Examples :DISPlay:GSMedge:DDEMod:SVIew:STIME SYMBo1
displays a red point at the symbol position.

Related Commands :DISPlay:GSMedge:DDEMod:SVIew:EINVerse,
:DISPlay:GSMedge:DDEMod:SVIew:FORMat,
[:SENSe]:GSMedge:MODulation

:DISPlay:GSMedge:DDEMod:SVIew:X[:SCALE]:OFFSet(?)

Sets or queries the minimum horizontal value (left edge) in the subview in the GSM/EDGE analysis.

Syntax :DISPlay:GSMedge:DDEMod:SVIew:X[:SCALE]:OFFSet <value>

 :DISPlay:GSMedge:DDEMod:SVIew:X[:SCALE]:OFFSet?

Arguments <value>::=<NRf> specifies the minimum horizontal value in the subview. Refer to *Note on Horizontal Scaling* on page 2-184 for setting the scale.

Measurement Modes DEMGSMEDGE

Examples :DISPlay:GSMedge:DDEMod:SVIew:X:SCALE:OFFSet -2.5
 sets the minimum horizontal value to -2.5 when the subview displays the constellation.

Related Commands :DISPlay:GSMedge:DDEMod:SVIew:FORMat

:DISPlay:GSMedge:DDEMod:SVIew:X[:SCALE]:RANGe(?)

Sets or queries full-scale value of the horizontal axis in the subview in the GSM/EDGE analysis.

Syntax :DISPlay:GSMedge:DDEMod:SVIew:X[:SCALE]:RANGe <value>

 :DISPlay:GSMedge:DDEMod:SVIew:X[:SCALE]:RANGe?

Arguments <value>::=<NRf> specifies full-scale value of the horizontal axis in the subview. Refer to *Note on Horizontal Scaling* on page 2-184 for setting the scale.

Measurement Modes DEMGSMEDGE

Examples :DISPlay:GSMedge:DDEMod:SVIew:X:SCALE:RANGe 2.5
 sets full-scale value of the horizontal axis to 2.5 when the subview displays the constellation.

Related Commands :DISPlay:GSMedge:DDEMod:SVIew:FORMat

:DISPlay:GSMedge:DDEMod:SVIew:Y[:SCALE]:FIT (No Query Form)

Runs auto-scale on the subview in the GSM/EDGE analysis.

The auto-scale automatically sets the start value and scale of the vertical axis to fit the waveform to the screen.

This command is valid when :DISPlay:GSMedge:DDEMod:SVIew:FORMat is set to IQVTime, FVTime, EVM, MERRor, or PERRor.

Syntax :DISPlay:GSMedge:DDEMod:SVIew:Y[:SCALE]:FIT

Arguments None

Measurement Modes DEMGSMEDGE

Examples :DISPlay:GSMedge:DDEMod:SVIew:Y:SCALE:FIT
runs the auto-scale on the subview.

Related Commands :DISPlay:GSMedge:DDEMod:SVIew:FORMat

:DISPlay:GSMedge:DDEMod:SVIew:Y[:SCALE]:FULL (No Query Form)

Sets the vertical axis in the subview to the default full-scale value in the GSM/EDGE analysis.

This command is valid when :DISPlay:GSMedge:DDEMod:SVIew:FORMat is set to IQVTime, FVTime, EVM, MERRor, or PERRor.

Syntax :DISPlay:GSMedge:DDEMod:SVIew:Y[:SCALE]:FULL

Arguments None

Measurement Modes DEMGSMEDGE

Examples :DISPlay:GSMedge:DDEMod:SVIew:Y:SCALE:FULL
sets the vertical axis in the subview to the default full-scale value.

Related Commands :DISPlay:GSMedge:DDEMod:SVIew:FORMat

:DISPlay:GSMedge:DDEMod:SVIew:Y[:SCALe]:OFFSet(?)

Sets or queries the minimum vertical value (bottom edge) in the subview in the GSM/EDGE analysis.

This command is valid when :DISPlay:GSMedge:DDEMod:SVIew:FORMat is set to IQVTime, FVTime, EVM, MERRor, or PERRor.

Syntax :DISPlay:GSMedge:DDEMod:SVIew:Y[:SCALe]:OFFSet <value>

Arguments <value>::=<NRf> specifies the minimum vertical value in the subview. The valid range depends on the display format. Refer to Table D-1 in *Appendix D*.

Measurement Modes DEMGSMEDGE

Examples :DISPlay:GSMedge:DDEMod:SVIew:Y:SCALe:OFFSet 10pct
sets the minimum vertical value to 10% when the subview displays EVM.

Related Commands :DISPlay:GSMedge:DDEMod:SVIew:FORMat

:DISPlay:GSMedge:DDEMod:SVIew:Y[:SCALE]:RANGe(?)

Sets or queries full-scale value of the vertical axis in the subview in the GSM/EDGE analysis.

This command is valid when :DISPlay:GSMedge:DDEMod:SVIew:FORMat is set to IQVTime, FVTime, EVM, MERRor, or PERRor.

Syntax :DISPlay:GSMedge:DDEMod:SVIew:Y[:SCALE]:RANGe <value>
:DISPlay:GSMedge:DDEMod:SVIew:Y[:SCALE]:RANGe?

Arguments <value>: :=<NRf> specifies full-scale value of the vertical axis in the subview. The valid range depends on the display format. Refer to Table D-1 in *Appendix D*.

Measurement Modes DEMGSMEDGE

Examples :DISPlay:GSMedge:DDEMod:SVIew:Y:SCALE:RANGe 50pct
sets full-scale value of the vertical axis to 50% when the subview displays EVM.

Related Commands :DISPlay:GSMedge:DDEMod:SVIew:FORMat

:DISPlay:GSMedge:SPECTrum Subgroup**GSM/EDGE, Option 24 Only**

The :DISPlay:GSMedge:SPECTrum commands control the spectrum display in the modulation spectrum, the switching spectrum, and the spurious measurements under the GSM/EDGE standard.

Command Tree	Header	Parameter
	:DISPlay	
	:GSMedge	
	:SPECTrum	
	:BMARker	
	:STATe	<boolean>
	:X	
	[:SCALE]	
	:OFFSet	<frequency>
	:PDIVsion	<frequency>
	:Y	
	[:SCALE]	
	:FIT	
	:FULL	
	:OFFSet	<amplitude>
	:PDIVsion	<amplitude>

Prerequisites for Use

To use a command from this group, you must have run at least the following two commands:

1. Run the following command to set the measurement mode to GSM/EDGE:

```
:INSTRument[:SElect] "DEMGSMEDGE"
```

2. Run one of the following commands to start the modulation spectrum, the switching spectrum, or the spurious measurement.

- To start the measurement with the default settings:

```
:CONFIgure:GSMedge:MODulation
:CONFIgure:GSMedge:SWITching or
:CONFIgure:GSMedge:SPURious
```
- To start the measurement without modifying the current settings:

```
[:SENSe]:GSMedge:MEASurement { MODulation | SWITching
| SPURious }
```

:DISPlay:GSMedge:SPECTrum:BMARker:STATe(?)

Determines whether to show the spurious marker in the spurious (SPURious) measurement.

Syntax :DISPlay:GSMedge:SPECTrum:BMARker:STATe { OFF | ON | 0 | 1 }
 :DISPlay:GSMedge:SPECTrum:BMARker:STATe?

Arguments OFF or 0 hides the spurious marker.
 ON or 1 shows the spurious marker.

Measurement Modes DEMGSMEDGE

Examples :DISPlay:GSMedge:SPECTrum:BMARker:STATe ON
 shows the spurious marker in the spurious measurement.

:DISPlay:GSMedge:SPECTrum:X[:SCALE]:OFFSet(?)

Sets or queries the minimum value (left edge) of the horizontal axis (frequency) in the spectrum view.

Syntax :DISPlay:GSMedge:SPECTrum:X[:SCALE]:OFFSet <freq>

 :DISPlay:GSMedge:SPECTrum:X[:SCALE]:OFFSet?

Arguments <freq> ::= <NRf> specifies the minimum horizontal value in the spectrum view. Refer to *Note on Horizontal Scaling* on page 2-184 for setting the scale.

Measurement Modes DEMGSMEDGE

Examples :DISPlay:GSMedge:SPECTrum:X:SCALE:OFFSet 100MHz
 sets the minimum horizontal value to 100 MHz.

Related Commands [:SENSe]:FREQuency:BAND?

:DISPlay:GSMedge:SPECTrum:X[:SCALE]:PDIVision(?)

Sets or queries the horizontal scale (frequency per division) in the spectrum view.

Syntax :DISPlay:GSMedge:SPECTrum:X[:SCALE]:PDIVision <freq>

 :DISPlay:GSMedge:SPECTrum:X[:SCALE]:PDIVision?

Arguments <freq> ::= <NRf> sets the horizontal scale (frequency per division).
Range: 5 Hz to 2 MHz (Baseband), 5 Hz to 300 MHz (RF).
Refer to *Note on Horizontal Scaling* on page 2-184 for setting the scale.

Measurement Modes DEMGSMEDGE

Examples :DISPlay:GSMedge:SPECTrum:X:SCALE:PDIVision 100.0E+3
 sets the horizontal scale to 100 kHz/div.

:DISPlay:GSMedge:SPECTrum:Y[:SCALe]:FIT (No Query Form)

Runs auto-scale on the spectrum view.

The auto-scale automatically sets the start value and scale of the vertical axis to fit the waveform to the screen.

Syntax :DISPlay:GSMedge:SPECTrum:Y[:SCALe]:FIT

Arguments None

Measurement Modes DEMGSMEDGE

Examples :DISPlay:GSMedge:SPECTrum:Y:SCALe:FIT
runs the auto-scale on the spectrum view.

:DISPlay:GSMedge:SPECTrum:Y[:SCALe]:FULL (No Query Form)

Sets the vertical axis to the default full-scale value in the spectrum view.

Syntax :DISPlay:GSMedge:SPECTrum:Y[:SCALe]:FULL

Arguments None

Measurement Modes DEMGSMEDGE

Examples :DISPlay:GSMedge:SPECTrum:Y:SCALe:FULL
sets the vertical axis to the default full-scale value in the spectrum view.

:DISPlay:GSMedge:SPECTrum:Y[:SCALe]:OFFSet(?)

Sets or queries the minimum vertical, or amplitude, value (bottom) in the spectrum view.

Syntax :DISPlay:GSMedge:SPECTrum:Y[:SCALe]:OFFSet <ampl>

 :DISPlay:GSMedge:SPECTrum:Y[:SCALe]:OFFSet?

Arguments <ampl>: :=<NRf> sets the minimum vertical value. Range: -200 to +100 dBm.

Measurement Modes DEMGSMEDGE

Examples :DISPlay:GSMedge:SPECTrum:Y:SCALe:OFFSet -100
 sets the minimum vertical value to -100 dBm.

:DISPlay:GSMedge:SPECTrum:Y[:SCALe]:PDIVision(?)

Sets or queries the vertical, or amplitude, scale (per division) in the spectrum view.

Syntax :DISPlay:GSMedge:SPECTrum:Y[:SCALe]:PDIVision <ampl>

 :DISPlay:GSMedge:SPECTrum:Y[:SCALe]:PDIVision?

Arguments <freq>: :=<NRf> specifies the horizontal scale in the spectrum view.
 Range: 0 to 10 dB/div.

Measurement Modes DEMGSMEDGE

Examples :DISPlay:GSMedge:SPECTrum:Y:SCALe:PDIVision 10
 sets the vertical scale to 10 dB/div.

:DISPlay:GSMedge:WAVeform Subgroup**GSM/EDGE, Option 24 Only**

The :DISPlay:GSMedge:WAVeform commands control the time domain display in the main view of the mean carrier power and the power versus time measurements under the GSM/EDGE standard.

Command Tree	Header	Parameter
	:DISPlay	
	:GSMedge	
	:WAVeform	
	:BURSt	FULL REDGe FEDGe
	:X	
	[:SCALe]	
	:OFFSet	<time>
	:PDIVsion	<time>
	:Y	
	[:SCALe]	
	:FIT	
	:FULL	
	:OFFSet	<amplitude>
	:PDIVsion	<amplitude>

Prerequisites for Use

To use a command from this group, you must have run at least the following two commands:

1. Run the following command to set the measurement mode to GSM/EDGE:

```
:INSTrument[:SElect] "DEMGSMEDGE"
```

2. Run one of the following commands to start the mean carrier power or the power versus time measurement:

- To start the measurement with the default settings:

```
:CONFIgure:GSMedge:MCPower or
:CONFIgure:GSMedge:PVTime
```

- To start the measurement without modifying the current settings:

```
[:SENSe]:GSMedge:MEASurement { MCPower | PVTime }
```

:DISPlay:GSMedge:WAVeform:BURSt(?)

Selects or queries how to expand a burst in the power versus time (PVTime) measurement.

This command is executed only when display data exists.

Syntax :DISPlay:GSMedge:WAVeform:BURSt { FULL | REDGe | FEDGe }

:DISPlay:GSMedge:WAVeform:BURSt?

Arguments FULL displays the entire burst.

REDGe expands the rising edge horizontally.

FEDGe expands the falling edge horizontally.

Measurement Modes DEMGSMEDGE

Examples :DISPlay:GSMedge:WAVeform:BURSt REDGe
expands the rising edge horizontally.

:DISPlay:GSMedge:WAVeform:X[:SCALe]:OFFSet(?)

Sets or queries the minimum value of the horizontal axis (left edge) in the time domain display.

Syntax :DISPlay:GSMedge:WAVeform:X[:SCALe]:OFFSet <time>
:DISPlay:GSMedge:WAVeform:X[:SCALe]:OFFSet?

Arguments <time>::=<NRf> sets the minimum horizontal value.
Refer to *Note on Horizontal Scaling* on page 2-184 for setting the scale.

Measurement Modes DEMGSMEDGE

Examples :DISPlay:GSMedge:WAVeform:X:SCALe:OFFSet -100us
sets the minimum horizontal value to -100 μ s.

:DISPlay:GSMedge:WAVeform:X[:SCALe]:PDIVision(?)

Sets or queries the horizontal, or time, scale (per division) in the time domain display.

Syntax :DISPlay:GSMedge:WAVeform:X[:SCALe]:PDIVision <time>
:DISPlay:GSMedge:WAVeform:X[:SCALe]:PDIVision?

Arguments <time>::=<NRf> specifies the horizontal scale.
Refer to *Note on Horizontal Scaling* on page 2-184 for setting the scale.

Measurement Modes DEMGSMEDGE

Examples :DISPlay:GSMedge:WAVeform:X:SCALe:PDIVision 10us
sets the horizontal scale to 10 μ s/div.

:DISPlay:GSMedge:WAVEform:Y[:SCALE]:FIT (No Query Form)

Runs auto-scale on the time domain display. The auto-scale automatically sets the start value and scale of the vertical axis to fit the waveform to the screen.

Syntax :DISPlay:GSMedge:WAVEform:Y[:SCALE]:FIT

Arguments None

Measurement Modes DEMGSMEDGE

Examples :DISPlay:GSMedge:WAVEform:Y:SCALE:FIT
runs the auto-scale.

:DISPlay:GSMedge:WAVEform:Y[:SCALE]:FULL (No Query Form)

Sets the vertical axis in the time domain display to the default full-scale value.

Syntax :DISPlay:GSMedge:WAVEform:Y[:SCALE]:FULL

Arguments None

Measurement Modes DEMGSMEDGE

Examples :DISPlay:GSMedge:WAVEform:Y:SCALE:FULL
sets the vertical axis in the time domain display to the default full-scale value.

:DISPlay:GSMedge:WAVeform:Y[:SCALe]:OFFSet(?)

Sets or queries the minimum value (bottom) of the vertical axis in the time domain display.

Syntax :DISPlay:GSMedge:WAVeform:Y[:SCALe]:OFFSet <amp1>

:DISPlay:GSMedge:WAVeform:Y[:SCALe]:OFFSet?

Arguments <amp1>::=<NRf> specifies the minimum value of the vertical axis. For the setting range, refer to Table D-1 in *Appendix D*.

Measurement Modes DEMGSMEDGE

Examples :DISPlay:GSMedge:WAVeform:Y:SCALe:OFFSet -100
sets the minimum vertical value to -100 dBm.

:DISPlay:GSMedge:WAVeform:Y[:SCALe]:PDIVision(?)

Sets the vertical axis scale (per division) in the time domain display.

Syntax :DISPlay:GSMedge:WAVeform:Y[:SCALe]:PDIVision <amp1>

:DISPlay:GSMedge:WAVeform:Y[:SCALe]:PDIVision?

Arguments <amp1>::=<NRf> specifies the vertical scale. For the setting range, refer to Table D-1 in *Appendix D*.

Measurement Modes DEMGSMEDGE

Examples :DISPlay:GSMedge:WAVeform:Y:SCALe:PDIVision 10
sets the vertical scale to 10 dB/div.

:DISPlay:FLCDMA2K|:RLCDMA2K:CCDF Subgroup

cdma2000, Option 25 Only

The :DISPlay:FLCDMA2K|:RLCDMA2K:CCDF commands control the CCDF measurement view under the cdma2000 forward or reverse link standard.

Command Tree	Header	Parameter
	:DISPlay	
	:FLCDMA2K :RLCDMA2K	
	:CCDF	
	:LINE	
	:GAUSSian	
	[:STATE]	<boolean>
	:REFERence	
	[:STATE]	<boolean>
	:STORe	
	:X	
	[:SCALE]	
	:AUTO	<boolean>
	:MAXimum	<numeric_value>
	:OFFSet	<numeric_value>
	:Y	
	[:SCALE]	
	:FIT	
	:FULL	
	:MAXimum	
	:MINimum	

:DISPlay:FLCDMA2K|RLCDMA2K:CCDF:LINE:GAUSSian[:STATe](?)

Determines whether to display the Gaussian line on the CCDF view.

Syntax :DISPlay:FLCDMA2K|RLCDMA2K:CCDF:LINE:GAUSSian[:STATe]
{ ON | OFF | 1 | 0 }

:DISPlay:FLCDMA2K|RLCDMA2K:CCDF:LINE:GAUSSian[:STATe]?

Arguments ON or 1 enables the Gaussian line display.
OFF or 0 disables the Gaussian line display.

Measurement Modes DEMFLCDMA2K, DEMRLCDMA2K

Examples :DISPlay:FLCDMA2K:CCDF:LINE:GAUSSian ON
displays the Gaussian line on the CCDF view under the cdma2000 forward link standard.

:DISPlay:FLCDMA2K|RLCDMA2K:CCDF:LINE:REFerence[:STATe](?)

Determines whether to display the most recently stored reference line on the CCDF view. This command is available only when a reference line is stored in the instrument memory.

Syntax :DISPlay:FLCDMA2K|RLCDMA2K:CCDF:LINE:REFerence[:STATe]
{ ON | OFF | 1 | 0 }

:DISPlay:FLCDMA2K|RLCDMA2K:CCDF:LINE:REFerence[:STATe]?

Arguments ON or 1 enables to display the reference line.
OFF or 0 disables to display the reference line.

Measurement Modes DEMFLCDMA2K, DEMRLCDMA2K

Examples :DISPlay:FLCDMA2K:CCDF:LINE:REFerence ON
displays the most recently stored reference line on the CCDF view under the cdma2000 forward link standard.

Related Commands :DISPlay:FLCDMA2K|RLCDMA2K:CCDF:LINE:REFerence:STORE

:DISPlay:FLCDMA2K|RLCDMA2K:CCDF:LINE:REFeRence:STORe (No Query Form)

Stores the line currently being displayed on the CCDF view as a reference line.

Syntax :DISP1ay:FLCDMA2K|RLCDMA2K:CCDF:LINE:REFeRence:STORe

Arguments None

Measurement Modes DEMFLCDMA2K, DEMRLCDMA2K

Examples :DISP1ay:FLCDMA2K:CCDF:LINE:REFeRence:STORe
stores the line currently being displayed on the CCDF view as a reference line
under the cdma2000 forward link standard.

Related Commands :DISPLay:FL1XEVO|RLCDMA2K:CCDF:LINE:REFeRence:[:STATe]

:DISPlay:FLCDMA2K|RLCDMA2K:CCDF:X[:SCALe]:AUTO(?)

Determines whether to automatically set the horizontal, or power, scale in the CCDF view.

Syntax :DISPlay:FLCDMA2K|RLCDMA2K:CCDF:X[:SCALe]:AUTO
{ ON | OFF | 1 | 0 }
:DISPlay:FLCDMA2K|RLCDMA2K:CCDF:X[:SCALe]:AUTO?

Arguments ON or 1 specifies that the horizontal scale is set automatically.
OFF or 0 specifies that the horizontal scale is set manually (default). Use the :DISPlay:FLCDMA2K|RLCDMA2K:CCDF:X[:SCALe]:MAXimum and :DISPlay:FLCDMA2K|RLCDMA2K:CCDF:X[:SCALe]:OFFSet commands to set the horizontal axis.

Measurement Modes DEMFLCDMA2K, DEMRLCDMA2K

Examples :DISPlay:FLCDMA2K:CCDF:X:SCALe:AUTO ON
specifies that the horizontal scale is set automatically on the CCDF view under the cdma2000 forward link standard.

Related Commands :DISPlay:FLCDMA2K|RLCDMA2K:CCDF:X[:SCALe]:MAXimum
:DISPlay:FLCDMA2K|RLCDMA2K:CCDF:X[:SCALe]:OFFSet

:DISPlay:FLCDMA2K|RLCDMA2K:CCDF:X[:SCALE]:MAXimum(?)

Sets or queries the maximum horizontal, or power, scale in the CCDF view.

Syntax :DISPlay:FLCDMA2K|RLCDMA2K:CCDF:X[:SCALE]:MAXimum <value>
 :DISPlay:FLCDMA2K|RLCDMA2K:CCDF:X[:SCALE]:MAXimum?

Arguments <value>::=<NRf> specifies the maximum horizontal value.
 Range: 0 to 15.01 dB.
 Refer to *Note on Horizontal Scaling* on page 2-184 for setting the scale.

Measurement Modes DEMFLCDMA2K, DEMRLCDMA2K

Examples :DISPlay:FLCDMA2K:CCDF:X:SCALE:MAXimum 15dB
 sets the maximum horizontal value to 15 dB on the CCDF view under the
 cdma2000 forward link standard.

Related Commands :DISPlay:FLCDMA2K|RLCDMA2K:CCDF:X[:SCALE]:AUTO

:DISPlay:FLCDMA2K|RLCDMA2K:CCDF:X[:SCALE]:OFFSet(?)

Sets or queries the start value of the horizontal axis in the CCDF view.

Syntax :DISPlay:FLCDMA2K|RLCDMA2K:CCDF:X[:SCALE]:OFFSet <value>
 :DISPlay:FLCDMA2K|RLCDMA2K:CCDF:X[:SCALE]:OFFSet?

Arguments <value>::=<NRf> specifies the start value of the horizontal axis.
 Range: 0 to 15.01 dB.
 Refer to *Note on Horizontal Scaling* on page 2-184 for setting the scale.

Measurement Modes DEMFLCDMA2K, DEMRLCDMA2K

Examples :DISPlay:FLCDMA2K:CCDF:X:SCALE:OFFSet 10dB
 sets the start value of the horizontal axis to 10 dB on the CCDF view under the
 cdma2000 forward link standard.

Related Commands :DISPlay:FLCDMA2K|RLCDMA2K:CCDF:X[:SCALE]:AUTO

:DISPlay:FLCDMA2K|RLCDMA2K:CCDF:Y[:SCALE]:FIT (No Query Form)

Runs auto-scale on the CCDF view. The auto-scale automatically sets the start value and scale of the vertical axis so that the whole waveform is displayed on the screen.

Syntax :DISPlay:FLCDMA2K|RLCDMA2K:CCDF:Y[:SCALE]:FIT

Arguments None

Measurement Modes DEMFLCDMA2K, DEMRLCDMA2K

Examples :DISPlay:FLCDMA2K:CCDF:Y:SCALE:FIT
runs auto-scale on the CCDF view under the cdma2000 forward link standard.

:DISPlay:FLCDMA2K|RLCDMA2K:CCDF:Y[:SCALE]:FULL (No Query Form)

Sets the vertical axis to the default full-scale value in the CCDF view.

Syntax :DISPlay:FLCDMA2K|RLCDMA2K:CCDF:Y[:SCALE]:FULL

Arguments None

Measurement Modes DEMFLCDMA2K, DEMRLCDMA2K

Examples :DISPlay:FLCDMA2K:CCDF:Y:SCALE:FULL
sets the vertical axis to the default full-scale value in the CCDF view under the cdma2000 forward link standard.

:DISPlay:FLCDMA2K|:RLCDMA2K:CCDF:Y[:SCALE]:MAXimum(?)

Sets or queries the maximum vertical value (top) in the CCDF view.

Syntax :DISPlay:FLCDMA2K|:RLCDMA2K:CCDF:Y[:SCALE]:MAXimum <value>
 :DISPlay:FLCDMA2K|:RLCDMA2K:CCDF:Y[:SCALE]:MAXimum?

Arguments <value>::=<NRf> specifies the maximum vertical value.
 Range: 10⁻⁹ to 100%

Measurement Modes DEMFLCDMA2K, DEMRLCDMA2K

Examples :DISPlay:FLCDMA2K:CCDF:Y:SCALE:MAXimum 90PCT
 sets the maximum vertical value to 90% in the CCDF view under the cdma2000 forward link standard.

:DISPlay:FL1XEVD0|:RL1XEVD0:CCDF:Y[:SCALE]:MINimum(?)

Sets or queries the minimum vertical value (bottom) in the CCDF view.

Syntax :DISPlay:FLCDMA2K|:RLCDMA2K:CCDF:Y[:SCALE]:MINimum <value>
 :DISPlay:FLCDMA2K|:RLCDMA2K:CCDF:Y[:SCALE]:MINimum?

Arguments <value>::=<NRf> specifies the minimum vertical value.
 Range: 10⁻⁹ to 100%

Measurement Modes DEMFLCDMA2K, DEMRLCDMA2K

Examples :DISPlay:FLCDMA2K:CCDF:Y:SCALE:MINimum 20PCT
 sets the minimum vertical value to 20% in the CCDF view under the cdma2000 forward link standard.

:DISPlay:FLCDMA2K|:RLCDMA2K:DDEMod Subgroup*cdma2000, Option 25 Only*

The :DISPlay:FLCDMA2K|:RLCDMA2K:DDEMod commands control display of the main view and subview for the digital modulation related measurement under the cdma2000 forward link or reverse link standard.

Command Tree	Header	Parameter
	:DISPlay	
	:FLCDMA2K :RLCDMA2K	
	:DDEMod	
	:MView	
	:CORDer	HADamard BREVerse
	:FORMat	CDPower MACCuracy EVM MERRor PERRor PCGRam STABle IQPower
	:X	
	[:SCALe]	
	:OFFSet	<numeric_value>
	:RANGe	<numeric_value>
	:Y	
	[:SCALe]	
	:FIT	
	:FULL	
	:OFFSet	<numeric_value>
	:PUNit	RELative ABSolute
	:RANGe	<numeric_value>
	:SView	
	:FORMat	SPECTrum IQPower CONSTe EVM MERRor PERRor
	:X	
	[:SCALe]	
	:OFFSet	<numeric_value>
	:RANGe	<numeric_value>
	:Y	
	[:SCALe]	
	:FIT	
	:FULL	
	:OFFSet	<numeric_value>
	:RANGe	<numeric_value>

:DISPlay:FLCDMA2K|:RLCDMA2K:DDEMod:MVlew:CORDer(?)

Sets or queries the code order of the main view in the digital modulation related measurement. This command is available only when the code domain power measurement is enabled and the :DISPlay:FL1XEVD0|:RL1XEVD0:DDE-Mod:MVlew:FORMatcommand is set to CDPower or PCGram.

Syntax :DISPlay:FLCDMA2K|:RLCDMA2K:DDEMod:MVlew:CORDer
{ HADamard | BREVerse }
:DISPlay:FLCDMA2K|:RLCDMA2K:DDEMod:MVlew:CORDer?

Arguments HADamard specifies the hadamard code order.
BREVerse specifies bit reverse.

Measurement Modes DEMFLCDMA2K, DEMRLCDMA2K

Examples :DISPlay:FLCDMA2K:DDEMod:MVlew:CORDer HADamard
selects the hadamard code order for the code domain power measurement under the cdma2000 forward link standard.

Related Commands :DISPlay:FLCDMA2K|:RLCDMA2K:DDEMod:MVlew:FORMat

:DISPlay:FLCDMA2K[:RLCDMA2K:DDEMod:MVIew:FORMat(?)

Selects or queries the display format of the main view in the digital modulation related measurement.

Syntax :DISPlay:FLCDMA2K[:RLCDMA2K:DDEMod:MVIew:FORMat { CDPower | MACCuracy | EVM | MERRor | PERRor | PCGRam | STABle | IQPower }
:DISPlay:FLCDMA2K[:RLCDMA2K:DDEMod:MVIew:FORMat?

Arguments The arguments and display formats are listed below:

Table 2-49: Display format of the main view

Argument	Display format
CDPower	Code domain power
MACCuracy	Modulation accuracy
EVM	Error vector magnitude (EVM)
MERRor	Amplitude error
PERRor	Phase error
PCGRam	Power codogram
STABle	Symbol table
IQPower	IQ power graph

NOTE. The arguments *CDPower*, *PCGRam*, and *IQPower* are available only when the [:SENSe]:FLCDMA2K[:RLCDMA2K:MEASurement command is set to *CDPower*. The arguments *MACCuracy*, *EVM*, *MERRor*, *PERRor*, and *STABle* are available only when the [:SENSe]:FLCDMA2K[:RLCDMA2K:MEASurement command is set to *MACCuracy*.

Measurement Modes DEMFLCDMA2K, DEMRLCDMA2K

Examples :DISPlay:FLCDMA2K:DDEMod:MVIew:FORMat CDPower
selects the code domain power measurement under the cdma2000 forward link standard.

Related Commands :DISPlay:FLCDMA2K[:RLCDMA2K:DDEMod:SVIew:FORMat
[:SENSe]:FLCDMA2K[:RLCDMA2K:MEASurement

:DISPlay:FLCDMA2K|:RLCDMA2K:DDEMod:MVlew:X[:SCALE]:OFFSet(?)

Sets or queries the minimum horizontal value (left edge) in the main view during the digital modulation related measurement.

Syntax :DISPlay:FLCDMA2K|:RLCDMA2K:DDEMod:MVlew:X[:SCALE]:OFFset <value>
:DISPlay:FLCDMA2K|:RLCDMA2K:DDEMod:MVlew:X[:SCALE]:OFFset?

Arguments <value>::=<NRf> specifies the minimum horizontal value in the main view. Refer to *Note on Horizontal Scaling* on page 2-184 for setting the scale.

Measurement Modes DEMFLCDMA2K, DEMRLCDMA2K

Examples :DISPlay:FLCDMA2K:DDEMod:MVlew:X:SCALE:OFFSet 10
sets the minimum horizontal value to 10 chips when the main view displays EVM under the cdma2000 forward link standard.

Related Commands :DISPlay:FLCDMA2K|:RLCDMA2K:DDEMod:MVlew:FORMat

:DISPlay:FLCDMA2K|:RLCDMA2K:DDEMod:MVlew:X[:SCALE]:RANGe(?)

Sets or queries the full-scale value of the horizontal axis in the main view during the digital modulation related measurement.

Syntax :DISPlay:FLCDMA2K|:RLCDMA2K:DDEMod:MVlew:X[:SCALE]:RANGe <value>
:DISPlay:FLCDMA2K|:RLCDMA2K:DDEMod:MVlew:X[:SCALE]:RANGe?

Arguments <value>::=<NRf> specifies the full-scale value of the horizontal axis in the main view. Refer to *Note on Horizontal Scaling* on page 2-184 for setting the scale.

Measurement Modes DEMFLCDMA2K, DEMRLCDMA2K

Examples :DISPlay:FLCDMA2K:DDEMod:MVlew:X:SCALE:RANGe 512
sets the full-scale value of the horizontal axis to 512 chips when the main view displays EVM under the cdma2000 forward link standard.

Related Commands :DISPlay:FLCDMA2K|:RLCDMA2K:DDEMod:MVlew:FORMat

:DISPlay:FLCDMA2K|:RLCDMA2K:DDEMod:MVIew:Y[:SCALE]:FIT (No Query Form)

Runs auto-scale on the main view during the digital modulation related measurement. The auto-scale automatically sets the start value and scale of the vertical axis so that the whole waveform is displayed on the screen.

Syntax :DISPlay:FLCDMA2K|:RLCDMA2K:DDEMod:MVIew:Y[:SCALE]:FIT

Arguments None

Measurement Modes DEMFLCDMA2K, DEMRLCDMA2K

Examples :DISPlay:FLCDMA2K:DDEMod:MVIew:Y:SCALE:FIT
runs auto-scale on the main view under the cdma2000 forward link standard.

Related Commands :DISPlay:FLCDMA2K|:RLCDMA2K:DDEMod:MVIew:FORMat

:DISPlay:FLCDMA2K|:RLCDMA2K:DDEMod:MVIew:Y[:SCALE]:FULL (No Query Form)

Sets the vertical axis in the main view to the default full-scale value during the digital modulation related measurement.

Syntax :DISPlay:FLCDMA2K|RLCDMA2K:DDEMod:MVIew:Y[:SCALE]:FULL

Arguments None

Measurement Modes DEMFLCDMA2K, DEMRLCDMA2K

Examples :DISPlay:FLCDMA2K:DDEMod:MVIew:Y:SCALE:FULL
sets the vertical axis in the main view to the default full-scale value under the cdma2000 forward link standard.

Related Commands :DISPlay:FLCDMA2K|:RLCDMA2K:DDEMod:MVIew:FORMat

:DISPlay:FLCDMA2K|:RLCDMA2K:DDEMod:MVlew:Y[:SCALE]:OFFSet(?)

Sets or queries the minimum vertical value (bottom) in the main view during the digital modulation related measurement.

Syntax :DISPlay:FLCDMA2K|:RLCDMA2K:DDEMod:MVlew:Y[:SCALE]:OFFSet <value>
 :DISPlay:FLCDMA2K|:RLCDMA2K:DDEMod:MVlew:Y[:SCALE]:OFFSet?

Arguments <value>: :=<NRf> specifies the minimum vertical value in the main view. The valid range depends on the display format. Refer to Table D-6 in *Appendix D*.

Measurement Modes DEMFLCDMA2K, DEMRLCDMA2K

Examples :DISPlay:FLCDMA2K:DDEMod:MVlew:Y:SCALE:OFFSet -1mPCT
 sets the minimum vertical value to -1m% when the main view displays EVM under the cdma2000 forward link standard.

Related Commands :DISPlay:FLCDMA2K|:RLCDMA2K:DDEMod:MVlew:FORMat

:DISPlay:FLCDMA2K|:RLCDMA2K:DDEMod:MVlew:Y[:SCALE]:PUNit(?)

Selects or queries the unit on the Y, or power, axis in the main view during the digital modulation related measurement. This command is available only when the :DISPlay:FL1XEVD0|:RL1XEVD0:DDEMod :MVlew:FORMat command is set to CDPower or PCGRam.

Syntax :DISPlay:FLCDMA2K|:RLCDMA2K:DDEMod:MVlew:Y[:SCALE]:PUNit
{ RELative | ABSolute }
:DISPlay:FLCDMA2K|:RLCDMA2K:DDEMod:MVlew:Y[:SCALE]:PUNit?

Arguments RELative represents the relative channel power to the total power of all the channels along the Y axis in dB.
ABSolute represents the absolute power of each channel along the Y axis in dBm.

Measurement Modes DEMFLCDMA2K, DEMRLCDMA2K

Examples :DISPlay:FLCDMA2K:DDEMod:MVlew:Y:SCALE:PUNit ABSolute
sets the Y axis unit in the main view to Absolute under the cdma2000 forward link standard.

Related Commands :DISPlay:FLCDMA2K|:RLCDMA2K:DDEMod:MVlew:FORMat

:DISPlay:FLCDMA2K|:RLCDMA2K:DDEMod:MVIew:Y[:SCALe]:RANGe(?)

Sets or queries the full-scale value of the vertical axis in the main view during the digital modulation related measurement.

Syntax :DISPlay:FLCDMA2K|:RLCDMA2K:DDEMod:MVIew:Y[:SCALe]:RANGe <value>
 :DISPlay:FLCDMA2K|:RLCDMA2K:DDEMod:MVIew:Y[:SCALe]:RANGe?

Arguments <value>: :=<NRf> specifies the full-scale value of the vertical axis in the main view. The valid range depends on the display format. Refer to Table D-6 in *Appendix D*.

Measurement Modes DEMFLCDMA2K, DEMRLCDMA2K

Examples :DISPlay:FLCDMA2K:DDEMod:MVIew:Y:SCALe:RANGe 10PCT
 sets the full-scale value of the vertical axis to 10% when the main view displays EVM under the cdma2000 forward link standard.

Related Commands :DISPlay:FLCDMA2K|:RLCDMA2K:DDEMod:MVIew:FORMat

:DISPlay:FLCDMA2K|:RLCDMA2K:DDEMod:SVIew:FORMat(?)

Selects or queries the display format of the subview in the digital modulation related measurement.

Syntax :DISPlay:FLCDMA2K|:RLCDMA2K:DDEMod:SVIew:FORMat { SPECTrum
| IQPower | CONStE | EVM | MERRor | PERRor }
:DISPlay:FLCDMA2K|:RLCDMA2K:DDEMod:SVIew:FORMat?

Arguments The arguments and display formats are listed below:

Table 2-50: Display format in the subview

Argument	Display format
SPECTrum	Spectrum
IQPower	IQ power graph
CONStE	Constellation
EVM	Error vector magnitude (EVM)
MERRor	Amplitude error
PERRor	Phase error

NOTE. The IQPower argument is available only when the [:SENSe]:FLCDMA2K|:RLCDMA2K:MEASurement command is set to CDPower or MACCuracy.

Measurement Modes DEMFLCDMA2K, DEMRLCDMA2K

Examples :DISPlay:FLCDMA2K:DDEMod:SVIew:FORMat SPECTrum
displays the spectrum in the subview under the cdma2000 forward link standard.

Related Commands :DISPlay:FLCDMA2K|RLCDMA2K:DDEMod:MVIew:FORMat

:DISPlay:FLCDMA2K|RLCDMA2K:DDEMod:SVIew:X[:SCALE]:OFFSet(?)

Sets or queries the minimum horizontal value (left edge) in the main view during the digital modulation related measurement.

Syntax :DISPlay:FLCDMA2K|RLCDMA2K:DDEMod:SVIew:X[:SCALE]:OFFset <value>
:DISPlay:FLCDMA2K|RLCDMA2K:DDEMod:SVIew:X[:SCALE]:OFFset?

Arguments <value>::=<NRf> specifies the minimum horizontal value in the subview. Refer to *Note on Horizontal Scaling* on page 2-184 for setting the scale.

Measurement Modes DEMFLCDMA2K, DEMRLCDMA2K

Examples :DISPlay:FLCDMA2K:DDEMod:SVIew:X:SCALE:OFFSet 10
sets the minimum horizontal value to 10 chips when the subview displays EVM under the cdma2000 forward link standard.

Related Commands :DISPlay:FLCDMA2K|RLCDMA2K:DDEMod:SVIew:FORMat

:DISPlay:FLCDMA2K|RLCDMA2K:DDEMod:SVIew:X[:SCALE]:RANGe(?)

Sets or queries the full-scale value of the horizontal axis in the subview during the digital modulation related measurement.

Syntax :DISPlay:FLCDMA2K|RLCDMA2K:DDEMod:SVIew:X[:SCALE]:RANGe <value>
:DISPlay:FLCDMA2K|RLCDMA2K:DDEMod:SVIew:X[:SCALE]:RANGe?

Arguments <value>::=<NRf> specifies the full-scale value of the horizontal axis in the subview. Refer to *Note on Horizontal Scaling* on page 2-184 for setting the scale.

Measurement Modes DEMFLCDMA2K, DEMRLCDMA2K

Examples :DISPlay:FLCDMA2K:DDEMod:SVIew:X:SCALE:RANGe 512
sets the full-scale value of the horizontal axis to 512 chips when the subview displays EVM under the cdma2000 forward link standard.

Related Commands :DISPlay:FLCDMA2K|RLCDMA2K:DDEMod:SVIew:FORMat

:DISPlay:FLCDMA2K|:RLCDMA2K:DDEMod:SVIew:Y[:SCALe]:FIT (No Query Form)

Runs auto-scale on the subview during the digital modulation related measurement. The auto-scale automatically sets the start value and scale of the vertical axis so that the whole waveform is displayed on the screen.

Syntax :DISPlay:FLCDMA2K|:RLCDMA2K:DDEMod:SVIew:Y[:SCALe]:FIT

Arguments None

Measurement Modes DEMFLCDMA2K, DEMRLCDMA2K

Examples :DISPlay:FLCDMA2K:DDEMod:SVIew:Y:SCALe:FIT
runs auto-scale on the subview under the cdma2000 forward link standard.

Related Commands :DISPlay:FLCDMA2K|:RLCDMA2K:DDEMod:SVIew:FORMat

:DISPlay:FLCDMA2K|:RLCDMA2K:DDEMod:SVIew:Y[:SCALe]:FULL (No Query Form)

Sets the vertical axis in the subview to the default full-scale value during the digital modulation related measurement.

Syntax :DISPlay:FLCDMA2K|:RLCDMA2K:DDEMod:SVIew:Y[:SCALe]:FULL

Arguments None

Measurement Modes DEMFLCDMA2K, DEMRLCDMA2K

Examples :DISPlay:FLCDMA2K:DDEMod:SVIew:Y:SCALe:FULL
sets the vertical axis in the subview to the default full-scale value under the cdma2000 forward link standard.

Related Commands :DISPlay:FLCDMA2K|:RLCDMA2K:DDEMod:SVIew:FORMat

:DISPlay:FLCDMA2K|:RLCDMA2K:DDEMod:SVIew:Y[:SCALe]:OFFSet(?)

Sets or queries the minimum vertical value (bottom) in the subview during the digital modulation related measurement.

Syntax :DISPlay:FLCDMA2K|:RLCDMA2K:DDEMod:SVIew:Y[:SCALe]:OFFSet <value>
 :DISPlay:FLCDMA2K|:RLCDMA2K:DDEMod:SVIew:Y[:SCALe]:OFFSet?

Arguments <value>::=<NRf> specifies the minimum vertical value in the subview. The valid range depends on the display format. Refer to Table D-6 in *Appendix D*.

Measurement Modes DEMFLCDMA2K, DEMRLCDMA2K

Examples :DISPlay:FLCDMA2K:DDEMod:SVIew:Y:SCALe:OFFSet -100dBm
 sets the minimum vertical value to -100 dBm when the subview displays spectrum under the cdma2000 forward link standard.

Related Commands :DISPlay:FLCDMA2K|:RLCDMA2K:DDEMod:SVIew:FORMat

:DISPlay:FLCDMA2K|:RLCDMA2K:DDEMod:SVIew:Y[:SCALe]:RANGe(?)

Sets or queries the full-scale value of the vertical axis in the subview during the digital modulation related measurement.

Syntax :DISPlay:FLCDMA2K|:RLCDMA2K:DDEMod:SVIew:Y[:SCALe]:RANGe <value>
 :DISPlay:FLCDMA2K|:RLCDMA2K:DDEMod:SVIew:Y[:SCALe]:RANGe?

Arguments <value>::=<NRf> specifies the full-scale value of the vertical axis in the subview. The valid range depends on the display format. Refer to Table D-6 in *Appendix D*.

Measurement Modes DEMFLCDMA2K, DEMRLCDMA2K

Examples :DISPlay:FLCDMA2K:DDEMod:SVIew:Y:SCALe:RANGe 100dB
 sets the full-scale value of the vertical axis to 100 dB when the subview displays spectrum under the cdma2000 forward link standard.

Related Commands :DISPlay:FLCDMA2K|:RLCDMA2K:DDEMod:SVIew:FORMat

:DISPlay:FLCDMA2K|:RLCDMA2K:SPECTrum Subgroup*cdma2000, Option 25 Only*

The :DISPlay:FL1XEVD0|:RL1XEVD0:SPECTrum commands control the spectrum display in the channel power, intermodulation, spectrum emission mask (SEM), and occupied bandwidth measurements under the cdma2000 forward link or reverse link standard.

Command Tree	Header	Parameter
	:DISPlay	
	:FLCDMA2K :RLCDMA2K	
	:SPECTrum	
	:X	
	[:SCALE]	
	:OFFSet	<numeric_value>
	:PDIVison	<numeric_value>
	:Y	
	[:SCALE]	
	:FIT	
	:FULL	
	:OFFSet	<numeric_value>
	:PDIVison	<numeric_value>

:DISPlay:FLCDMA2K|RLCDMA2K:SPECTrum:X[:SCALe]:OFFSet(?)

Sets or queries the minimum value (left edge) of the horizontal axis (frequency) in the spectrum view.

Syntax :DISPlay:FLCDMA2K|RLCDMA2K:SPECTrum:X[:SCALe]:OFFSet <value>

:DISPlay:FLCDMA2K|RLCDMA2K:SPECTrum:X[:SCALe]:OFFSet?

Arguments <value>::=<NRf> specifies the minimum horizontal value in the spectrum view. Refer to *Note on Horizontal Scaling* on page 2-184 for setting the scale.

Measurement Modes DEMFLCDMA2K, DEMRLCDMA2K

Examples :DISPlay:FLCDMA2K:SPECTrum:X:SCALe:OFFSet 100MHz
sets the minimum horizontal value to 100 MHz in the spectrum view under the cdma2000 forward link standard.

:DISPlay:FLCDMA2K|RLCDMA2K:SPECTrum:X[:SCALe]:PDIVision(?)

Sets or queries the horizontal, or frequency, scale (per division) in the spectrum view.

Syntax :DISPlay:FLCDMA2K|RLCDMA2K:SPECTrum:X[:SCALe]:PDIVision <value>

:DISPlay:FLCDMA2K|RLCDMA2K:SPECTrum:X[:SCALe]:PDIVision?

Arguments <value>::=<NRf> specifies the horizontal scale in the spectrum view. Refer to *Note on Horizontal Scaling* on page 2-184 for setting the scale.

Measurement Modes DEMFLCDMA2K, DEMRLCDMA2K

Examples :DISPlay:FLCDMA2K:SPECTrum:X:SCALe:PDIVision 100kHz
sets the horizontal scale to 100 kHz/div in the spectrum view under the cdma2000 forward link standard.

:DISPlay:FLCDMA2K|RLCDMA2K:SPECTrum:Y[:SCALE]:FIT (No Query Form)

Runs auto-scale on the spectrum view. The auto-scale automatically sets the start value and scale of the vertical axis so that the whole waveform is displayed on the screen.

Syntax :DISPlay:FLCDMA2K|RLCDMA2K:SPECTrum:Y[:SCALE]:FIT

Arguments None

Measurement Modes DEMFLCDMA2K, DEMRLCDMA2K

Examples :DISPlay:FLCDMA2K:SPECTrum:Y:SCALE:FIT
runs auto-scale on the spectrum view under the cdma2000 forward link standard.

:DISPlay:FLCDMA2K|RLCDMA2K:SPECTrum:Y[:SCALE]:FULL (No Query Form)

Sets the vertical axis to the default full-scale value in the spectrum view.

Syntax :DISPlay:FLCDMA2K|RLCDMA2K:SPECTrum:Y[:SCALE]:FULL

Arguments None

Measurement Modes DEMFLCDMA2K, DEMRLCDMA2K

Examples :DISPlay:FLCDMA2K:SPECTrum:Y:SCALE:FULL
sets the vertical axis to the default full-scale value in the spectrum view under the cdma2000 forward link standard.

:DISPlay:FLCDMA2K|:RLCDMA2K:SPECTrum:Y[:SCALE]:OFFSet(?)

Sets or queries the minimum vertical, or amplitude value (bottom) in the spectrum view.

Syntax :DISPlay:FLCDMA2K|:RLCDMA2K:SPECTrum:Y[:SCALE]:OFFSet <value>

:DISPlay:FLCDMA2K|:RLCDMA2K:SPECTrum:Y[:SCALE]:OFFSet?

Arguments <value>::=<NRf> specifies the minimum vertical value.
Range: -200 to 100 dBm

Measurement Modes DEMFLCDMA2K, DEMRLCDMA2K

Examples :DISPlay:FLCDMA2K:SPECTrum:Y:SCALE:OFFSet -100dBm
sets the minimum vertical value to -100 dBm in the spectrum view under the cdma2000 forward link standard.

:DISPlay:FLCDMA2K|:RLCDMA2K:SPECTrum:Y[:SCALE]:PDIVision(?)

Sets or queries the vertical, or amplitude, scale (per division) in the spectrum view.

Syntax :DISPlay:FLCDMA2K|:RLCDMA2K:SPECTrum:Y[:SCALE]:PDIVision <value>

:DISPlay:FLCDMA2K|:RLCDMA2K:SPECTrum:Y[:SCALE]:PDIVision?

Arguments <value>::=<NRf> specifies the vertical scale in the spectrum view.
Range: 0 to 10 dB/div

Measurement Modes DEMFLCDMA2K, DEMRLCDMA2K

Examples :DISPlay:FLCDMA2K:SPECTrum:Y:SCALE:PDIVision 10
sets the vertical scale to 10 dB/div in the spectrum view under the cdma2000 forward link standard.

:DISPlay:RLCDMA2K:WAVEform Subgroup*cdma2000, Option 25 Only*

The :DISPlay:RLCDMA2K:WAVEform commands control the time domain display in the main view of the gated output power measurement under the cdma2000 reverse link standard.

Command Tree	Header	Parameter
	:DISPlay	
	:RLCDMA2K	
	:WAVEform	
	:X	
	[:SCALE]	
	:OFFSet	<numeric_value>
	:PDIVison	<numeric_value>
	:Y	
	[:SCALE]	
	:FIT	
	:FULL	
	:OFFSet	<numeric_value>
	:PDIVison	<numeric_value>

:DISPlay:RLCDMA2K:WAVeform:X[:SCALe]:OFFSet(?)

Sets or queries the minimum value (left edge) of the horizontal axis (frequency) in the time domain display.

Syntax :DISPlay:RLCDMA2K:WAVeform:X[:SCALe]:OFFSet <value>

:DISPlay:RLCDMA2K:WAVeform:X[:SCALe]:OFFSet?

Arguments <value>::=<NRf> specifies the minimum horizontal value.
Range: approximately -416.67 μ s to approximately 415 μ s
(since the resolution of the time axis depends on the span setting of the instrument, the upper and lower limit values are set to the nearest value of a multiple of its resolution.)

Measurement Modes DEMRLCDMA2K

Examples :DISPlay:RLCDMA2K:WAVeform:X:SCALe:OFFSet -100us
sets the minimum horizontal value to -100 μ s in the time domain display under the cdma2000 reverse link standard.

:DISPlay:RLCDMA2K:WAVeform:X[:SCALe]:PDIVision(?)

Sets or queries the horizontal, or time, scale (per division) in the time domain display.

Syntax :DISPlay:RLCDMA2K:WAVeform:X[:SCALe]:PDIVision <value>

:DISPlay:RLCDMA2K:WAVeform:X[:SCALe]:PDIVision?

Arguments <value>::=<NRf> specifies the horizontal scale.
Range: approximately 0.1627 μ s to approximately 833.33 μ s
(since the resolution of the time axis depends on the span setting of the instrument, the upper and lower limit values are set to the nearest value of a multiple of its resolution.)

Measurement Modes DEMRLCDMA2K

Examples :DISPlay:FLCDMA2K:WAVeform:X:SCALe:PDIVision 10us
sets the horizontal scale to 10 μ s/div in the time domain display under the cdma2000 forward link standard.

:DISPlay:RLCDMA2K:WAVEform:Y[:SCALE]:FIT (No Query Form)

Runs auto-scale on the time domain display. The auto-scale automatically sets the start value and scale of the vertical axis so that the whole waveform is displayed on the screen.

Syntax :DISPlay:RLCDMA2K:WAVEform:Y[:SCALE]:FIT

Arguments None

Measurement Modes DEMRLCDMA2K

Examples :DISPlay:FLCDMA2K:WAVEform:Y:SCALE:FIT
runs auto-scale on the time domain display under the cdma2000 reverse link standard.

:DISPlay:RLCDMA2K:WAVEform:Y[:SCALE]:FULL (No Query Form)

Sets the vertical axis to the default full-scale value in the time domain display.

Syntax :DISPlay:RLCDMA2K:WAVEform:Y[:SCALE]:FULL

Arguments None

Measurement Modes DEMRLCDMA2K

Examples :DISPlay:RLCDMA2K:WAVEform:Y:SCALE:FULL
sets the vertical axis to the default full-scale value in the time domain display under the cdma2000 reverse link standard.

:DISPlay:RLCDMA2K:WAVeform:Y[:SCALe]:OFFSet(?)

Sets or queries the minimum vertical, or amplitude value (bottom) in the time domain display.

Syntax :DISPlay:RLCDMA2K:WAVeform:Y[:SCALe]:OFFSet <value>

:DISPlay:RLCDMA2K:WAVeform:Y[:SCALe]:OFFSet?

Arguments <value>::=<NRf> specifies the minimum vertical value.
Range: -200 to 100 dBm

Measurement Modes DEMRLCDMA2K

Examples :DISPlay:RLCDMA2K:WAVeform:Y:SCALe:OFFSet -100dBm
sets the minimum vertical value to -100 dBm in the time domain display under the cdma2000 reverse link standard.

:DISPlay:RLCDMA2K:WAVeform:Y[:SCALe]:PDIVision(?)

Sets or queries the vertical, or amplitude, scale (per division) in the time domain display.

Syntax :DISPlay:RLCDMA2K:WAVeform:Y[:SCALe]:PDIVision <numeric_value>

:DISPlay:RLCDMA2K:WAVeform:Y[:SCALe]:PDIVision?

Arguments <value>::=<NRf> specifies the vertical scale in the time domain display.
Range: 1.0 E-5 to 10 dB

Measurement Modes DEMRLCDMA2K

Examples :DISPlay:RLCDMA2K:WAVeform:Y:SCALe:PDIVision 10dB
sets the vertical scale to 10 dB/div in the time domain display under the cdma2000 reverse link standard.

:DISPlay:FL1XEVD0|:RL1XEVD0:CCDF Subgroup**1xEV-DO, Option 26 Only**

The :DISPlay:FL1XEVD0|:RL1XEVD0:CCDF commands control the CCDF measurement view under the 1xEV-DO forward link or reverse link standard.

Command Tree	Header	Parameter
	:DISPlay	
	:FL1XEVD0 :RL1XEVD0	
	:CCDF	
	:LINE	
	:GAUSSian	
	[:STATe]	<boolean>
	:REFerence	
	[:STATe]	<boolean>
	:STORe	
	:X	
	[:SCALe]	
	:AUTO	<boolean>
	:MAXimum	<numeric_value>
	:OFFSet	<numeric_value>
	:Y	
	[:SCALe]	
	:FIT	
	:FULL	
	:MAXimum	<numeric_value>
	:MINimum	<numeric_value>

:DISPlay:FL1XEVD0|:RL1XEVD0:CCDF:LINE:GAUSSian[:STATe](?)

Determines whether to display the Gaussian line on the CCDF view.

Syntax :DISPlay:FL1XEVD0|:RL1XEVD0:CCDF:LINE:GAUSSian[:STATe] { ON | OFF
| 1 | 0 }

:DISPlay:FL1XEVD0|:RL1XEVD0:CCDF:LINE:GAUSSian[:STATe]?

Arguments ON or 1 enables the Gaussian line display.

OFF or 0 disables the Gaussian line display.

Measurement Modes DEMFL1XEVD0, DEMRL1XEVD0

Examples :DISPlay:FL1XEVD0:CCDF:LINE:GAUSSian:STATe ON
displays the Gaussian line on the CCDF view under the 1xEV-DO forward link standard.

:DISPlay:FL1XEVD0|:RL1XEVD0:CCDF:LINE:REFerence[:STATe](?)

Determines whether to display the most recently stored reference line on the CCDF view. This command is available only when a reference line is stored in the instrument memory.

Syntax :DISPlay:FL1XEVD0|RL1XEVD0:CCDF:LINE:REFerence[:STATe] { ON | OFF
| 1 | 0 }

:DISPlay:FL1XEVD0|RL1XEVD0:CCDF:LINE:REFerence[:STATe]?

Arguments ON or 1 enables to display the reference line.

OFF or 0 disables to display the reference line.

Measurement Modes DEMFL1XEVD0, DEMRL1XEVD0

Examples :DISPlay:FL1XEVD0:CCDF:LINE:REFerence:STATe ON
displays the most recently stored reference line on the CCDF view under the 1xEV-DO forward link standard.

Related Commands :DISPlay:FL1XEVD0|:RL1XEVD0:CCDF:LINE:REFerence:STORE

:DISPlay:FL1XEVD0|:RL1XEVD0:CCDF:LINE:REFeRence:STORe (No Query Form)

Stores the line currently being displayed on the CCDF view as a reference line.

Syntax :DISPlay:FL1XEVD0|:RL1XEVD0:CCDF:LINE:REFeRence:STORe

Arguments None

Measurement Modes DEMFL1XEVD0, DEMRL1XEVD0

Examples :DISPlay:FL1XEVD0:CCDF:LINE:REFeRence:STORe
stores the line currently being displayed on the CCDF view as a reference line under the 1xEV-DO forward link standard.

Related Commands :DISPLay:FL1XEVO|:RL1XEVD0:CCDF:LINE:REFeRence[::STATe]

:DISPlay:FL1XEVD0|:RL1XEVD0:CCDF:X[:SCALe]:AUTO(?)

Determines whether to automatically set the horizontal, or power, scale in the CCDF view.

Syntax :DISPlay:FL1XEVD0|:RL1XEVD0:CCDF:X[:SCALe]:AUTO { ON | OFF
 | 1 | 0 }
 :DISPlay:FL1XEVD0|:RL1XEVD0:CCDF:X[:SCALe]:AUTO?

Arguments ON or 1 specifies that the horizontal scale is set automatically.
 OFF or 0 specifies that the horizontal scale is set manually (default).
 Use the :DISPlay:FL1XEVD0|:RL1XEVD0:CCDF:X[:SCALe]:MAXimum
 and DISPlay:FL1XEVD0|:RL1XEVD0:CCDF:X[:SCALe]:OFFSet commands
 to set the horizontal axis.

Measurement Modes DEMFL1XEVD0, DEMRL1XEVD0

Examples :DISPlay:FL1XEVD0:CCDF:X:SCALe:AUTO ON
 specifies that the horizontal scale is set automatically on the CCDF view under
 the 1xEV-DO forward link standard.

Related Commands :DISPlay:FL1XEVD0|:RL1XEVD0:CCDF:X[:SCALe]:MAXimum,
 :DISPlay:FL1XEVD0|:RL1XEVD0:CCDF:X[:SCALe]:OFFSet

:DISPlay:FL1XEVD0|:RL1XEVD0:CCDF:X[:SCALe]:MAXimum(?)

Sets or queries the maximum horizontal, or power, scale in the CCDF view.

Syntax :DISPlay:FL1XEVD0|:RL1XEVD0:CCDF:X[:SCALe]:MAXimum <value>
:DISPlay:FL1XEVD0|:RL1XEVD0:CCDF:X[:SCALe]:MAXimum?

Arguments <value>::=<NRf> specifies the maximum horizontal value.
Range: 0 to 15.01 dB.
Refer to *Note on Horizontal Scaling* on page 2-184 for setting the scale.

Measurement Modes DEMFL1XEVD0, DEMRL1XEVD0

Examples :DISPlay:FL1XEVD0:CCDF:X:SCALe:MAXimum 15dB
sets the maximum horizontal value to 15 dB on the CCDF view under the 1xEV-DO forward link standard.

Related Commands :DISPlay:FL1XEVD0|:RL1XEVD0:CCDF:X[:SCALe]:AUTO

:DISPlay:FL1XEVD0|:RL1XEVD0:CCDF:X[:SCALe]:OFFSet(?)

Sets or queries the start value of the horizontal axis in the CCDF view.

Syntax :DISPlay:FL1XEVD0|:RL1XEVD0:CCDF:X[:SCALe]:OFFSet <value>
:DISPlay:FL1XEVD0|:RL1XEVD0:CCDF:X[:SCALe]:OFFSet?

Arguments <value>::=<NRf> specifies the start value of the horizontal axis.
Range: 0 to 15.01 dB.
Refer to *Note on Horizontal Scaling* on page 2-184 for setting the scale.

Measurement Modes DEMFL1XEVD0, DEMRL1XEVD0

Examples :DISPlay:FL1XEVD0:CCDF:X:SCALe:OFFSet 10dB
sets the start value of the horizontal axis to 10 dB on the CCDF view under the 1xEV-DO forward link standard.

Related Commands :DISPlay:FL1XEVD0|:RL1XEVD0:CCDF:X[:SCALe]:AUTO

:DISPlay:FL1XEVD0|:RL1XEVD0:CCDF:Y[:SCALE]:FIT (No Query Form)

Runs auto-scale on the CCDF view. The auto-scale automatically sets the start value and scale of the vertical axis so that the whole waveform is displayed on the screen.

Syntax :DISPlay:FL1XEVD0|:RL1XEVD0:CCDF:Y[:SCALE]:FIT

Arguments None

Measurement Modes DEMFL1XEVD0, DEMRL1XEVD0

Examples :DISPlay:FL1XEVD0:CCDF:Y:SCALE:FIT
runs auto-scale on the CCDF view under the 1xEV-DO forward link standard.

:DISPlay:FL1XEVD0|:RL1XEVD0:CCDF:Y[:SCALE]:FULL (No Query Form)

Sets the vertical axis to the default full-scale value in the CCDF view.

Syntax :DISPlay:FL1XEVD0|:RL1XEVD0:CCDF:Y[:SCALE]:FULL

Arguments None

Measurement Modes DEMFL1XEVD0, DEMRL1XEVD0

Examples :DISPlay:FL1XEVD0:CCDF:Y:SCALE:FULL
sets the vertical axis to the default full-scale value in the CCDF view under the 1xEV-DO forward link standard.

:DISPlay:FL1XEVD0|:RL1XEVD0:CCDF:Y[:SCALe]:MAXimum(?)

Sets or queries the maximum vertical value (top) in the CCDF view.

Syntax :DISPlay:FL1XEVD0|:RL1XEVD0:CCDF:Y[:SCALe]:MAXimum <value>
:DISPlay:FL1XEVD0|:RL1XEVD0:CCDF:Y[:SCALe]:MAXimum?

Arguments <value>::=<NRf> specifies the maximum vertical value. Range: 10⁻⁹ to 100%

Measurement Modes DEMFL1XEVD0, DEMRL1XEVD0

Examples :DISPlay:FL1XEVD0:CCDF:Y:SCALe:MAXimum 90PCT
sets the maximum vertical value to 90% in the CCDF view under the 1xEV-DO forward link standard.

:DISPlay:FL1XEVD0|:RL1XEVD0:CCDF:Y[:SCALe]:MINimum(?)

Sets or queries the minimum vertical value (bottom) in the CCDF view.

Syntax :DISPlay:FL1XEVD0|:RL1XEVD0:CCDF:Y[:SCALe]:MINimum <value>
:DISPlay:FL1XEVD0|:RL1XEVD0:CCDF:Y[:SCALe]:MINimum?

Arguments <value>::=<NRf> specifies the minimum vertical value. Range: 10⁻⁹ to 100%

Measurement Modes DEMFL1XEVD0, DEMRL1XEVD0

Examples :DISPlay:FL1XEVD0:CCDF:Y:SCALe:MINimum 20PCT
sets the minimum vertical value to 20% in the CCDF view under the 1xEV-DO forward link standard.

:DISPlay:FL1XEVD0|:RL1XEVD0:DDEMod Subgroup**1xEV-DO, Option 26 Only**

The :DISPlay:FL1XEVD0|:RL1XEVD0:DDEMod commands control display of the main view and subview for the digital modulation related measurement under the 1xEV-DO forward link or reverse link standard.

Command Tree	Header	Parameter
	:DISPlay	
	:FL1XEVD0 :RL1XEVD0	
	:DDEMod	
	:MView	
	:CORDer	HADamard BREVerse
	:FORMat	CDPower MACCuracy EVM MERRor PERRor PCGRam STABle IQPower
	:X	
	[:SCALe]	
	:OFFSet	<numeric_value>
	:RANGe	<numeric_value>
	:Y	
	[:SCALe]	
	:FIT	
	:FULL	
	:OFFSet	<numeric_value>
	:PUNit	RELative ABSolute
	:RANGe	<numeric_value>
	:SView	
	:FORMat	SPECtrum IQPower CONSTe EVM MERRor PERRor
	:X	
	[:SCALe]	
	:OFFSet	<numeric_value>
	:RANGe	<numeric_value>
	:Y	
	[:SCALe]	
	:FIT	
	:FULL	
	:OFFSet	<numeric_value>
	:RANGe	<numeric_value>

:DISPlay:FL1XEVD0|:RL1XEVD0:DDEMod:MVIew:CORDer(?)

Sets or queries the code order of the main view in the digital modulation related measurement. This command is valid when the code domain power measurement is enabled and :DISPlay:FL1XEVD0|:RL1XEVD0:DDEMod:MVIew:FORMat is CDPower or PCGram.

Syntax :DISPlay:FL1xEVD0|:RL1XEVD0:DDEMod:MVIew:CORDer
 { HADamard | BREVerse }
 :DISPlay:FL1xEVD0|:RL1XEVD0:DDEMod:MVIew:CORDer?

Arguments HADamard specifies the hadamard code order.
 BREVerse specifies bit reverse.

Measurement Modes DEMFL1XEVD0, DEMRL1XEVD0

Examples :DISPlay:FL1XEVD0:DDEMod:MVIew:CORDer HADamard
 selects the hadamard code order for the code domain power measurement under the 1xEV-DO forward link standard.

Related Commands :DISPlay:FL1XEVD0|:RL1XEVD0:DDEMod:MVIew:FORMat

:DISPlay:FL1XEVD0|:RL1XEVD0:DDEMod:MVlew:FORMat(?)

Selects or queries the display format of the main view in the digital modulation related measurement.

Syntax :DISPlay:FL1XEVD0|:RL1XEVD0:DDEMod:MVlew:FORMat { CDPower | MACCuracy | EVM | MERRor | PERRor | PCGRam | STABle | IQPower }

:DISPlay:FL1XEVD0|:RL1XEVD0:DDEMod:MVlew:FORMat?

Arguments The arguments and display formats are listed below:

Table 2-51: Display format of the main view

Argument	Display format
CDPower	Code domain power
MACCuracy	Modulation accuracy
EVM	Error vector magnitude (EVM)
MERRor	Amplitude error
PERRor	Phase error
PCGRam	Power codogram
STABle	Symbol table
IQPower	IQ power graph

NOTE. The CDPower, PCGRam, and IQPower arguments are available only when the [:SENSe]:FL1XEVD0|:RL1XEVD0:MEASurement command is set to CDPower. The MACCuracy, EVM, MERRor, PERRor, and STABle arguments are available only when the [:SENSe]:FL1XEVD0|:RL1XEVD0:MEASurement command is set to MACCuracy.

Measurement Modes DEMFL1XEVD0, DEMRL1XEVD0

Examples :DISPlay:FL1XEVD0:DDEMod:MVlew:FORMat CDPower
selects the code domain power measurement under the 1xEV-DO forward link standard.

Related Commands :DISPlay:FL1XEVD0|:RL1XEVD0:DDEMod:SVlew:FORMat, [:SENSe]:FL1XEVD0|:RL1XEVD0:MEASurement

:DISPlay:FL1XEVD0|:RL1XEVD0:DDEMod:MView:X[:SCALE]:OFFSet(?)

Sets or queries the minimum horizontal value (left edge) in the main view during the digital modulation related measurement.

Syntax :DISPlay:FL1XEVD0|:RL1XEVD0:DDEMod:MView:X[:SCALE]:OFFSet <value>
:DISPlay:FL1XEVD0|:RL1XEVD0:DDEMod:MView:X[:SCALE]:OFFSet?

Arguments <value>::=<Nrf> specifies the minimum horizontal value in the main view. Refer to *Note on Horizontal Scaling* on page 2-184 for setting the scale.

Measurement Modes DEMFL1XEVD0, DEMRL1XEVD0

Examples :DISPlay:FL1XEVD0:DDEMod:MView:X:SCALE:OFFSet 10
sets the minimum horizontal value to 10 chips when the main view displays EVM under the 1xEV-DO forward link standard.

Related Commands :DISPlay:FL1XEVD0|:RL1XEVD0:DDEMod:MView:FORMat

:DISPlay:FL1XEVD0|:RL1XEVD0:DDEMod:MView:X[:SCALE]:RANGe(?)

Sets or queries the full-scale value of the horizontal axis in the main view during the digital modulation related measurement.

Syntax :DISPlay:FL1XEVD0|:RL1XEVD0:DDEMod:MView:X[:SCALE]:RANGe <value>
:DISPlay:FL1XEVD0|:RL1XEVD0:DDEMod:MView:X[:SCALE]:RANGe?

Arguments <value>::=<Nrf> specifies the full-scale value of the horizontal axis in the main view. Refer to *Note on Horizontal Scaling* on page 2-184 for setting the scale.

Measurement Modes DEMFL1XEVD0, DEMRL1XEVD0

Examples :DISPlay:FL1XEVD0:DDEMod:MView:X:SCALE:RANGe 512
sets the full-scale value of the horizontal axis to 512 chips when the main view displays EVM under the 1xEV-DO forward link standard.

Related Commands :DISPlay:FL1XEVD0|:RL1XEVD0:DDEMod:MView:FORMat

:DISPlay:FL1XEVD0|:RL1XEVD0:DDEMod:MVlew:Y[:SCALE]:FIT (No Query Form)

Runs auto-scale on the main view during the digital modulation related measurement. The auto-scale automatically sets the start value and scale of the vertical axis so that the whole waveform is displayed on the screen.

Syntax :DISPlay:FL1XEVD0|:RL1XEVD0:DDEMod:MVlew:Y[:SCALE]:FIT

Arguments None

Measurement Modes DEMFL1XEVD0, DEMRL1XEVD0

Examples :DISPlay:FL1XEVD0:DDEMod:MVlew:Y:SCALE:FIT
runs auto-scale on the main view under the 1xEV-DO forward link standard.

Related Commands :DISPlay:FL1XEVD0|:RL1XEVD0:DDEMod:MVlew:FORMat

:DISPlay:FL1XEVD0|:RL1XEVD0:DDEMod:MVlew:Y[:SCALE]:FULL (No Query Form)

Sets the vertical axis in the main view to the default full-scale value during the digital modulation related measurement.

Syntax :DISPlay:FL1XEVD0|:RL1XEVD0:DDEMod:MVlew:Y[:SCALE]:FULL

Arguments None

Measurement Modes DEMFL1XEVD0, DEMRL1XEVD0

Examples :DISPlay:FL1XEVD0:DDEMod:MVlew:Y:SCALE:FULL
sets vertical axis in the main view to the default full-scale value under the 1xEV-DO forward link standard.

Related Commands :DISPlay:FL1XEVD0|:RL1XEVD0:DDEMod:MVlew:FORMat

:DISPlay:FL1XEVD0|:RL1XEVD0:DDEMod:MVIew:Y[:SCALe]:OFFSet(?)

Sets or queries the minimum vertical value in the main view (bottom) during the digital modulation related measurement.

Syntax :DISPlay:FL1XEVD0|:RL1XEVD0:DDEMod:MVIew:Y[:SCALe]:OFFSet <value>
:DISPlay:FL1XEVD0|:RL1XEVD0:DDEMod:MVIew:Y[:SCALe]:OFFSet?

Arguments <value>: :=<NRf> specifies the minimum vertical value in the main view. The valid range depends on the display format. Refer to Table D-7 in *Appendix D*.

Measurement Modes DEMFL1XEVD0, DEMRL1XEVD0

Examples :DISPlay:FL1XEVD0:DDEMod:MVIew:Y:SCALe:OFFSet -10PCT
sets the minimum vertical value to -10% when the main view displays EVM under the 1xEV-DO forward link standard.

Related Commands :DISPlay:FL1XEVD0|:RL1XEVD0:DDEMod:MVIew:FORMat

:DISPlay:FL1XEVD0|:RL1XEVD0:DDEMod:MVlew:Y[:SCALe]:PUNit(?)

Selects or queries the unit on the Y, or power, axis in the main view during the digital modulation related measurement. This command is available only when the :DISPlay:FL1XEVD0|:RL1XEVD0:DDEMod :MVlew:FORMat command is set to CDPower or PCGRam.

Syntax :DISPlay:FL1XEVD0|:RL1XEVD0:DDEMod:MVlew:Y[:SCALe]:PUNit
{ RELative | ABSolute }
:DISPlay:FL1XEVD0|:RL1XEVD0:DDEMod:MVlew:Y[:SCALe]:PUNit?

Arguments RELative represents the relative channel power to the total power of all the channels along the Y axis in dB.
ABSolute represents the absolute power of each channel along the Y axis in dBm.

Measurement Modes DEMFL1XEVD0, DEMRL1XEVD0

Examples :DISPlay:FL1XEVD0:DDEMod:MVlew:Y:SCALe:PUNit ABSolute
sets the Y axis unit in the main view to Absolute under the 1xEV-DO forward link standard.

Related Commands :DISPlay:FL1XEVD0|:RL1XEVD0:DDEMod:MVlew:FORMat

:DISPlay:FL1XEVD0|:RL1XEVD0:DDEMod:MVIew:Y[:SCALe]:RANGe(?)

Sets or queries the full-scale value of the vertical axis in the main view during the digital modulation related measurement.

Syntax :DISPlay:FL1XEVD0|:RL1XEVD0:DDEMod:MVIew:Y[:SCALe]:RANGe <value>
:DISPlay:FL1XEVD0|:RL1XEVD0:DDEMod:MVIew:Y[:SCALe]:RANGe?

Arguments <value>: :=<NRf> specifies the full-scale value of the vertical axis in the main view. The valid range depends on the display format. Refer to Table D-7 in *Appendix D*.

Measurement Modes DEMFL1XEVD0, DEMRL1XEVD0

Examples :DISPlay:FL1XEVD0:DDEMod:MVIew:Y:SCALe:RANGe 10PCT
sets the full-scale value of the vertical axis to 10% when the main view displays EVM under the 1xEV-DO forward link standard.

Related Commands :DISPlay:FL1XEVD0|:RL1XEVD0:DDEMod:MVIew:FORMat

:DISPlay:FL1XEVD0|:RL1XEVD0:DDEMod:SVIew:FORMat(?)

Selects or queries the display format of the subview in the digital modulation related measurement.

Syntax :DISPlay:FL1XEVD0|:RL1XEVD0:DDEMod:SVIew:FORMat { SPECTrum
 | IQPower | CONSte | EVM | MERRor | PERRor }
 :DISPlay:FL1XEVD0|:RL1XEVD0:DDEMod:SVIew:FORMat?

Arguments The arguments and display formats are listed below:

Table 2-52: Display format in the subview

Argument	Display format
SPECTrum	Spectrum
IQPower	IQ power graph
CONSte	Constellation
EVM	Error vector magnitude (EVM)
MERRor	Amplitude error
PERRor	Phase error

NOTE. The argument *IQPower* is available only when the [:SENSe]:FL1XEVD0|:RL1XEVD0:MEASurement command is set to *CDPower* or *MACCuracy*.

Measurement Modes DEMFL1XEVD0, DEMRL1XEVD0

Examples :DISPlay:FL1XEVD0:DDEMod:SVIew:FORMat SPECTrum
displays the spectrum in the subview under the 1xEV-DO forward link standard.

Related Commands :DISPlay:FL1XEVD0|:RL1XEVD0:DDEMod:MVIew:FORMat

:DISPlay:FL1XEVD0|:RL1XEVD0:DDEMod:SVIew:X[:SCALe]:OFFSet(?)

Sets or queries the minimum horizontal value (left edge) in the main view during the digital modulation related measurement.

Syntax :DISPlay:FL1XEVD0|:RL1XEVD0:DDEMod:SVIew:X[:SCALe]:OFFSet <value>
:DISPlay:FL1XEVD0|:RL1XEVD0:DDEMod:SVIew:X[:SCALe]:OFFSet?

Arguments <value>::=<NRf> specifies the minimum horizontal value in the subview. Refer to *Note on Horizontal Scaling* on page 2-184 for setting the scale.

Measurement Modes DEMFL1XEVD0, DEMRL1XEVD0

Examples :DISPlay:FL1XEVD0:DDEMod:SVIew:X:SCALe:OFFSet 10
sets the minimum horizontal value to 10 chips when the subview displays EVM under the 1xEV-DO forward link standard.

Related Commands :DISPlay:FL1XEVD0|:RL1XEVD0:DDEMod:SVIew:FORMat

:DISPlay:FL1XEVD0|:RL1XEVD0:DDEMod:SVIew:X[:SCALe]:RANGe(?)

Sets or queries the full-scale value of the horizontal axis in the subview during the digital modulation related measurement.

Syntax :DISPlay:FL1XEVD0|:RL1XEVD0:DDEMod:SVIew:X[:SCALe]:RANGe <value>
:DISPlay:FL1XEVD0|:RL1XEVD0:DDEMod:SVIew:X[:SCALe]:RANGe?

Arguments <value>::=<NRf> specifies the full-scale value of the horizontal axis in the subview. Refer to *Note on Horizontal Scaling* on page 2-184 for setting the scale.

Measurement Modes DEMFL1XEVD0, DEMRL1XEVD0

Examples :DISPlay:FL1XEVD0:DDEMod:SVIew:X:SCALe:RANGe 512
sets the full-scale value of the horizontal axis to 512 chips when the subview displays EVM under the 1xEV-DO forward link standard.

Related Commands :DISPlay:FL1XEVD0|:RL1XEVD0:DDEMod:SVIew:FORMat

:DISPlay:FL1XEVD0|:RL1XEVD0:DDEMod:SVIew:Y[:SCALe]:FIT (No Query Form)

Runs auto-scale on the subview during the digital modulation related measurement. The auto-scale automatically sets the start value and scale of the vertical axis so that the whole waveform is displayed on the screen.

Syntax :DISPlay:FL1XEVD0|:RL1XEVD0:DDEMod:SVIew:Y[:SCALe]:FIT

Arguments None

Measurement Modes DEMFL1XEVD0, DEMRL1XEVD0

Examples :DISPlay:FL1XEVD0:DDEMod:SVIew:Y:SCALe:FIT
runs auto-scale on the subview under the 1xEV-DO forward link standard.

Related Commands :DISPlay:FL1XEVD0|:RL1XEVD0:DDEMod:SVIew:FORMat

:DISPlay:FL1XEVD0|:RL1XEVD0:DDEMod:SVIew:Y[:SCALe]:FULL (No Query Form)

Sets the vertical axis in the subview to the default full-scale value during the digital modulation related measurement.

Syntax :DISPlay:FL1XEVD0|:RL1XEVD0:DDEMod:SVIew:Y[:SCALe]:FULL

Arguments None

Measurement Modes DEMFL1XEVD0, DEMRL1XEVD0

Examples :DISPlay:FL1XEVD0:DDEMod:SVIew:Y:SCALe:FULL
sets the vertical axis in the subview to the default full-scale value under the 1xEV-DO forward link standard.

Related Commands :DISPlay:FL1XEVD0|:RL1XEVD0:DDEMod:SVIew:FORMat

:DISPlay:FL1XEVD0|:RL1XEVD0:DDEMod:SVIew:Y[:SCALe]:OFFSet(?)

Sets or queries the minimum vertical value in the subview (bottom) during the digital modulation related measurement.

Syntax :DISPlay:FL1XEVD0|:RL1XEVD0:DDEMod:SVIew:Y[:SCALe]:OFFSet <value>
:DISPlay:FL1XEVD0|:RL1XEVD0:DDEMod:SVIew:Y[:SCALe]:OFFSet?

Arguments <value>::=<NRf> specifies the minimum vertical value in the subview. The valid range depends on the display format. Refer to Table D-7 in *Appendix D*.

Measurement Modes DEMFL1XEVD0, DEMRL1XEVD0

Examples :DISPlay:FL1XEVD0:DDEMod:SVIew:Y:SCALe:OFFSet -100dBm
sets the minimum vertical value to -100 dBm when the subview displays spectrum under the 1xEV-DO forward link standard.

Related Commands :DISPlay:FL1XEVD0|:RL1XEVD0:DDEMod:SVIew:FORMat

:DISPlay:FL1XEVD0|:RL1XEVD0:DDEMod:SVIew:Y[:SCALe]:RANGe(?)

Sets or queries the full-scale value of the vertical axis in the subview during the digital modulation related measurement.

Syntax :DISPlay:FL1XEVD0|:RL1XEVD0:DDEMod:SVIew:Y[:SCALe]:RANGe <value>
:DISPlay:FL1XEVD0|:RL1XEVD0:DDEMod:SVIew:Y[:SCALe]:RANGe?

Arguments <value>::=<NRf> specifies the full-scale value of the vertical axis in the subview. The valid range depends on the display format. Refer to Table D-7 in *Appendix D*.

Measurement Modes DEMFL1XEVD0, DEMRL1XEVD0

Examples :DISPlay:FL1XEVD0:DDEMod:SVIew:Y:SCALe:RANGe 100dB
sets the full-scale value of the vertical axis to 100 dB when the subview displays spectrum under the 1xEV-DO forward link standard.

Related Commands :DISPlay:FL1XEVD0|:RL1XEVD0:DDEMod:SVIew:FORMat

:DISPlay:FL1XEVD0|:RL1XEVD0:SPECtrum Subgoup

1xEV-DO, Option 26 Only

The :DISPlay:FL1XEVD0|:RL1XEVD0:SPECtrum commands control the spectrum display in the channel power, intermodulation, spectrum emission mask (SEM), and occupied bandwidth measurements under the 1xEV-DO forward link or reverse link standard.

Command Tree	Header	Parameter
	:DISPlay	
	:FL1XEVD0 :RL1XEVD0	
	:SPECtrum	
	:X	
	[:SCALE]	
	:OFFSet	<numeric_value>
	:PDIVison	<numeric_value>
	:Y	
	[:SCALE]	
	:FIT	
	:FULL	
	:OFFSet	<numeric_value>
	:PDIVison	<numeric_value>

:DISPlay:FL1XEVD0|:RL1XEVD0:SPECTrum:X[:SCALe]:OFFSet(?)

Sets or queries the minimum value (left edge) of the horizontal axis (frequency) in the spectrum view.

Syntax :DISPlay:FL1XEVD0|:RL1XEVD0:SPECTrum:X[:SCALe]:OFFSet <value>
:DISPlay:FL1XEVD0|:RL1XEVD0:SPECTrum:X[:SCALe]:OFFSet?

Arguments <value>::=<NRf> specifies the minimum horizontal value in the spectrum view. Refer to *Note on Horizontal Scaling* on page 2-184 for setting the scale.

Measurement Modes DEMFL1XEVD0, DEMRL1XEVD0

Examples :DISPlay:FL1XEVD0:SPECTrum:X:SCALe:OFFSet 100MHZ
sets the minimum horizontal value to 100 MHz in the spectrum view under the 1xEV-DO forward link standard.

:DISPlay:FL1XEVD0|:RL1XEVD0:SPECTrum:X[:SCALe]:PDIVision(?)

Sets or queries the horizontal, or frequency, scale (per division) in the spectrum view.

Syntax :DISPlay:FL1XEVD0|:RL1XEVD0:SPECTrum:X[:SCALe]:PDIVision <value>
:DISPlay:FL1XEVD0|:RL1XEVD0:SPECTrum:X[:SCALe]:PDIVision?

Arguments <value>::=<NRf> specifies the horizontal scale in the spectrum view. Refer to *Note on Horizontal Scaling* on page 2-184 for setting the scale.

Measurement Modes DEMFL1XEVD0, DEMRL1XEVD0

Examples :DISPlay:FL1XEVD0:SPECTrum:X:SCALe:PDIVision 100kHz
sets the horizontal scale to 100 kHz/div in the spectrum view under the 1xEV-DO forward link standard.

:DISPlay:FL1XEVD0|:RL1XEVD0:SPECTrum:Y[:SCALe]:FIT (No Query Form)

Runs auto-scale on the spectrum view. The auto-scale automatically sets the start value and scale of the vertical axis so that the whole waveform is displayed on the screen.

Syntax :DISPlay:FL1XEVD0|:RL1XEVD0:SPECTrum:Y[:SCALe]:FIT

Arguments None

Measurement Modes DEMFL1XEVD0, DEMRL1XEVD0

Examples :DISPlay:FL1XEVD0:SPECTrum:Y:SCALe:FIT
runs auto-scale on the spectrum view under the 1xEV-DO forward link standard.

:DISPlay:FL1XEVD0|:RL1XEVD0:SPECTrum:Y[:SCALe]:FULL (No Query Form)

Sets the vertical axis to the default full-scale value in the spectrum view.

Syntax :DISPlay:FL1XEVD0|:RL1XEVD0:SPECTrum:Y[:SCALe]:FULL

Arguments None

Measurement Modes DEMFL1XEVD0, DEMRL1XEVD0

Examples :DISPlay:FL1XEVD0:SPECTrum:Y:SCALe:FULL
sets the vertical axis to the default full-scale value in the spectrum view under the 1xEV-DO forward link standard.

:DISPlay:FL1XEVD0|:RL1XEVD0:SPECTrum:Y[:SCALe]:OFFSet(?)

Sets or queries the minimum vertical, or amplitude value (bottom) in the spectrum view.

Syntax :DISPlay:FL1XEVD0|:RL1XEVD0:SPECTrum:Y[:SCALe]:OFFSet <value>
:DISPlay:FL1XEVD0|:RL1XEVD0:SPECTrum:Y[:SCALe]:OFFSet?

Arguments <value>::=<NRf> specifies the minimum vertical value.
Range: -200 to 100 dBm

Measurement Modes DEMFL1XEVD0, DEMRL1XEVD0

Examples :DISPlay:FL1XEVD0:SPECTrum:Y:SCALe:OFFSet -100dBm
sets the minimum vertical value to -100 dBm in the spectrum view under the 1xEV-DO forward link standard.

:DISPlay:FL1XEVD0|:RL1XEVD0:SPECTrum:Y[:SCALe]:PDIVision(?)

Sets or queries the vertical, or amplitude, scale (per division) in the spectrum view.

Syntax :DISPlay:FL1XEVD0|:RL1XEVD0:SPECTrum:Y[:SCALe]:PDIVision <value>
:DISPlay:FL1XEVD0|:RL1XEVD0:SPECTrum:Y[:SCALe]:PDIVision?

Arguments <value>::=<NRf> specifies the vertical scale in the spectrum view.
Range: 0 to 10 dB/div

Measurement Modes DEMFL1XEVD0, DEMRL1XEVD0

Examples :DISPlay:FL1XEVD0:SPECTrum:Y:SCALe:PDIVision 10dB
sets the vertical scale to 10 dB/div in the spectrum view under the 1xEV-DO forward link standard.

:DISPlay:FL1XEVD0:WAVEform Subgroup

1xEV-DO, Option 26 Only

The :DISPlay:FL1XEVD0:WAVEform commands control the time domain display in the main view of the gated output power measurement under the 1xEV-DO forward link standard.

Command Tree	Header	Parameter
	:DISPlay	
	:FL1XEVD0	
	:WAVEform	
	:X	
	[:SCALE]	
	:OFFSet	<numeric_value>
	:PDIVision	<numeric_value>
	:Y	
	[:SCALE]	
	:FIT	
	:FULL	
	:OFFSet	<numeric_value>
	:PDIVision	<numeric_value>

:DISPlay:FL1XEVD0:WAVEform:X[:SCALE]:OFFSet(?)

Sets or queries the minimum value (left edge) of the horizontal axis (frequency) in the time domain display.

Syntax :DISPlay:FL1XEVD0:WAVEform:X[:SCALE]:OFFSet <value>

:DISPlay:FL1XEVD0:WAVEform:X[:SCALE]:OFFSet?

Arguments <value>::=<NRf> specifies the minimum horizontal value.
Range: approximately $-416.67 \mu\text{s}$ to approximately $415 \mu\text{s}$
(since the resolution of the time axis depends on the span setting of the instrument, the upper and lower limit values are set to the nearest value of a multiple of its resolution.)

Measurement Modes DEMFL1XEVD0

Examples :DISPlay:FL1XEVD0:WAVEform:X:SCALE:OFFSet -100us
sets the minimum horizontal value to $-100 \mu\text{s}$ in the time domain display under the 1xEV-DO forward link standard.

:DISPlay:FL1XEVD0:WAVEform:X[:SCALE]:PDIVision(?)

Sets or queries the horizontal, or time, scale (per division) in the time domain display.

Syntax :DISPlay:FL1XEVD0:WAVEform:X[:SCALE]:PDIVision <value>

:DISPlay:FL1XEVD0:WAVEform:X[:SCALE]:PDIVision?

Arguments <value>::=<NRf> specifies the horizontal scale.
Range: approximately $0.1627 \mu\text{s}$ to approximately $833.33 \mu\text{s}$
(since the resolution of the time axis depends on the span setting of the instrument, the upper and lower limit values are set to the nearest value of a multiple of its resolution.)

Measurement Modes DEMFL1XEVD0

Examples :DISPlay:FL1XEVD0:WAVEform:X:SCALE:PDIVision 10us
sets the horizontal scale to $10 \mu\text{s}/\text{div}$ in the time domain display under the 1xEV-DO forward link standard.

:DISPlay:FL1XEVD0:WAVEform:Y[:SCALE]:FIT (No Query Form)

Runs auto-scale on the time domain display. The auto-scale automatically sets the start value and scale of the vertical axis so that the whole waveform is displayed on the screen.

Syntax :DISPlay:FL1XEVD0:WAVEform:Y[:SCALE]:FIT

Arguments None

Measurement Modes DEMFL1XEVD0

Examples :DISPlay:FL1XEVD0:WAVEform:Y:SCALE:FIT
runs auto-scale on the time domain display under the 1xEV-DO forward link standard.

:DISPlay:FL1XEVD0:WAVEform:Y[:SCALE]:FULL (No Query Form)

Sets the vertical axis to the default full-scale value in the time domain display.

Syntax :DISPlay:FL1XEVD0:WAVEform:Y[:SCALE]:FULL

Arguments None

Measurement Modes DEMFL1XEVD0

Examples :DISPlay:FL1XEVD0:WAVEform:Y:SCALE:FULL
sets the vertical axis to the default full-scale value in the time domain display under the 1xEV-DO forward link standard.

:DISPlay:FL1XEVD0:WAVEform:Y[:SCALE]:OFFSet(?)

Sets or queries the minimum vertical, or amplitude value (bottom) in the time domain display.

Syntax :DISPlay:FL1XEVD0:WAVEform:Y[:SCALE]:OFFSet <value>
:DISPlay:FL1XEVD0:WAVEform:Y[:SCALE]:OFFSet?

Arguments <value>::=<Nrf> specifies the minimum vertical value.
Range: -200 to 100 dB

Measurement Modes DEMFL1XEVD0

Examples :DISPlay:FL1XEVD0:WAVEform:Y:SCALE:OFFSet -100dBm
sets the minimum vertical value to -100 dBm in the time domain display under the 1xEV-DO forward link standard.

:DISPlay:FL1XEVD0:WAVEform:Y[:SCALE]:PDIVision(?)

Sets or queries the vertical, or amplitude, scale (per division) in the time domain display.

Syntax :DISPlay:FL1XEVD0:WAVEform:Y[:SCALE]:PDIVision <value>
:DISPlay:FL1XEVD0:WAVEform:Y[:SCALE]:PDIVision?

Arguments <value>::=<Nrf> specifies the vertical scale in the time domain display.
Range: 1.0 E-5 to 10 dB

Measurement Modes DEMFL1XEVD0

Examples :DISPlay:FL1XEVD0:WAVEform:Y:SCALE:PDIVision 10dB
sets the vertical scale to 10 dB/div in the time domain display under the 1xEV-DO forward link standard.

:DISPlay:DLR5_3GPP Subgroup

3GPP-R5, Option 27 Only

The :DISPlay:DLR5_3GPP commands control display of the 3GPP-R5 downlink modulation analysis.

NOTE. *To use a command from this group, you must have selected DEMDLR5_3G (3GPP-R5 downlink modulation analysis) in the :INSTrument[:SElect] command.*

Command Tree	Header	Parameter
	:DISPlay	
	:DLR5_3GPP	
	:AVIew	
	:CCODE	<number>
	:MSLot	
	:HEAD	<numeric_value>
	[:STATe]	<boolean>
	:SHORTcode	<number>
	:SRATE	COMPOSITE R960S R480S R240S R120S R60S R30S R15S R7P5S
	:SSCHpart	<boolean>
	:TSLot	<number>
	:MPIew :SVIew	
	:COLor	
	[:SCALE]	
	:OFFSet	<amplitude>
	:RANge	<relative_amplitude>
	:ELENgth	<numeric_value>
	:FORMat	OFF CSGRam CPCCode CPSHortcode CPSYmbol CPTSlot SCONste SVECTOR SEVM SMERror SPERror SIEYe SQEYe STEYe STABLE CONSte VECTOR SPECTrum
	:POWer	
	:SElect	CODE PSCH SSCH
	[:TOTal]	<boolean>
	:RADix	BINary OCTal HEXadecimal
	:ROtation	<numeric_value>
	:X	
	[:SCALE]	
	:OFFSet	<numeric_value>
	:RANge	<numeric_value>
	:Y	
	[:SCALE]	
	:FIT	
	:FULL	
	:OFFSet	<numeric_value>
	:PUNit	RELative ABSolute
	:RANge	<numeric_value>

:DISPlay:DLR5_3GPP:AVIew:CCODE(?)

Sets or queries the channelization code to position the marker in the 3GPP-R5 downlink modulation analysis.

Syntax :DISPlay:DLR5_3GPP:AVIew:CCODE <number>
 :DISPlay:DLR5_3GPP:AVIew:CCODE?

Arguments <number>::=<NR1> specifies the channelization code number.
 Range: Channel 0 to 511.

Measurement Modes DEMDLR5_3G

Examples :DISPlay:DLR5_3GPP:AVIew:CCODE 100
 sets the channelization code to 100 to position the marker.

:DISPlay:DLR5_3GPP:AVIew:MSLot:HEAD(?)

Sets or queries the index of the time slot to be displayed at the left edge on the view when :DISPlay:DLR5_3GPP:AVIew:MSLot[:STATe] is On. This function is not supported by local operation.

Syntax :DISPlay:DLR5_3GPP:AVIew:MSLot:HEAD <number>
 :DISPlay:DLR5_3GPP:AVIew:MSLot:HEAD?

Arguments <number>::=<NR1> specifies the index of the time slot to be displayed at the left edge on the view. Range: -15985 to -14.

When the number of analyzed time slots is 15 or less, this command has no effect on the analyzer setting and the query returns the value of $-\lceil(\text{the number of analyzed time slots}) - 1\rceil$.

Measurement Modes DEMDLR5_3G

Examples :DISPlay:DLR5_3GPP:AVIew:MSLot:HEAD -100
 sets the number of the head of the time slot to -100.

Related Commands :DISPlay:DLR5_3GPP:AVIew:MSLot[:STATe]

:DISPlay:DLR5_3GPP:AVIew:MSLot[:STATe](?)

Determines whether to display the multiple or the single slot. The multiple slot is valid when :DISPlay:DLR5_3GPP:MVIew:FORMat is set to CPSYmbol, CPRSlot, SEVM, SMERror, SPERror, or CSGRam

Syntax :DISPlay:DLR5_3GPP:AVIew:MSLot[:STATe] { OFF | ON | 0 | 1 }
:DISPlay:DLR5_3GPP:AVIew:MSLot[:STATe]?

Arguments OFF or 0 displays the single slot.
ON or 1 displays the multiple slot. You can specify the index of the time slot to be displayed at the left edge on the view with the :DISPlay:DLR5_3GPP:AVIew:MSLot:HEAD command.

Measurement Modes DEMDLR5_3G

Examples :DISPlay:DLR5_3GPP:AVIew:MSLot:STATe ON
displays the multiple slot.

Related Commands :DISPlay:DLR5_3GPP:AVIew:MSLot:HEAD,
:DISPlay:DLR5_3GPP:MVIew:FORMat

:DISPlay:DLR5_3GPP:AVIew:SHORtcode(?)

Sets or queries the short code (channelization code) to position the marker in the 3GPP-R5 downlink modulation analysis.

This command is equivalent to :DISPlay:DLR5_3GPP:AVIew:CCODE.

Syntax :DISPlay:DLR5_3GPP:AVIew:SHORtcode <number>
 :DISPlay:DLR5_3GPP:AVIew:SHORtcode?

Arguments <number>::=<NR1> specifies the short code number.
 Range: Channel 0 to 511.

Measurement Modes DEMDLR5_3G

Examples :DISPlay:DLR5_3GPP:AVIew:SHORtcode 100
 sets the short code to 100 to position the marker.

Related Commands :DISPlay:DLR5_3GPP:AVIew:CCODE

:DISPlay:DLR5_3GPP:AVIew:SRATe(?)

Sets or queries the symbol rate for the measurement in the 3GPP-R5 downlink modulation analysis.

Syntax :DISPlay:DLR5_3GPP:AVIew:SRATe { COMPOSITE | R960S | R480S
| R240S | R120S | R60S | R30S | R15S | R7P5S }
:DISPlay:DLR5_3GPP:AVIew:SRATe?

Arguments The arguments specify the symbol rates as listed below:

Table 2-53: Symbol rate settings

Argument	Symbol rate
COMPOSITE (default)	Corresponds to multi-rate
R960S	960 k
R480S	480 k
R240S	240 k
R120S	120 k
R60S	60 k
R30S	30 k
R15S	15 k
R7P5S	7.5 k

NOTE. If a normal analysis does not result, select OFF in the [:SENSe] :DLR5_3GPP:COMPOSITE command and then select one of the symbol rates (other than COMPOSITE) listed in Table 3-10.

Measurement Modes DEMDLR5_3G

Examples :DISPlay:DLR5_3GPP:AVIew:SRATe R960S
sets the symbol rate to 960 k.

Related Commands [:SENSe]:DLR5_3GPP:COMPOSITE

:DISPlay:DLR5_3GPP:AVIew:SSCHpart(?)

Determines whether to show SCH at the head of data in the 3GPP-R5 downlink modulation analysis.

Syntax :DISPlay:DLR5_3GPP:AVIew:SSCHpart { OFF | ON | 0 | 1 }
 :DISPlay:DLR5_3GPP:AVIew:SSCHpart?

Arguments OFF or 0 hides SCH.
 ON or 1 shows SCH.

Measurement Modes DEMDLR5_3G

Examples :DISPlay:DLR5_3GPP:AVIew:SSCHpart ON
 shows SCH.

:DISPlay:DLR5_3GPP:AVIew:TSLot(?)

Sets or queries the number of the time slot to be displayed in the 3GPP-R5 downlink modulation analysis.

Syntax :DISPlay:DLR5_3GPP:AVIew:TSLot <number>
 :DISPlay:DLR5_3GPP:AVIew:TSLot?

Arguments <number>::=<NR1> specifies the number of the time slot to be displayed.
 Range: Slot -15999 to 0.

Measurement Modes DEMDLR5_3G

Examples :DISPlay:DLR5_3GPP:AVIew:TSLot -100
 sets the time slot number to -100.

:DISPlay:DLR5_3GPP:MView|:SVIew:COLor[:SCALe]:OFFSet(?)

Sets or queries the minimum value on the color, or amplitude, axis when the view displays a spectrogram in the 3GPP-R5 modulation analysis.

Syntax :DISPlay:DLR5_3GPP:MView|:SVIew:COLor[:SCALe]:OFFSet <value>
:DISPlay:DLR5_3GPP:MView|:SVIew:COLor[:SCALe]:OFFSet?

Arguments <value>::=<NRf> specifies the minimum value on the color axis.
Range: -100 to 0 dBm.

Measurement Modes DEMDLR5_3G

Examples :DISPlay:DLR5_3GPP:MView:COLor:SCALe:OFFSet -100
sets the minimum value on the color axis in the main view to -100 dBm.

Related Commands :DISPlay:DLR5_3GPP:MView|:SVIew:FORMat

:DISPlay:DLR5_3GPP:MView|:SVIew:COLor[:SCALe]:RANGe(?)

Sets or queries full-scale value of the color, or amplitude, axis when the view displays a spectrogram in the 3GPP-R5 modulation analysis.

Syntax :DISPlay:DLR5_3GPP:MView|:SVIew:COLor[:SCALe]:RANGe <value>
:DISPlay:DLR5_3GPP:MView|:SVIew:COLor[:SCALe]:RANGe?

Arguments <value>::={ 5 | 10 | 20 | 50 } [dB] specifies full-scale value of the color axis in the spectrogram view.

Measurement Modes DEMDLR5_3G

Examples :DISPlay:DLR5_3GPP:MView:COLor:SCALe:RANGe 50
sets full-scale value of the color axis to 50 dB.

Related Commands :DISPlay:DLR5_3GPP:MView|:SVIew:FORMat

:DISPlay:DLR5_3GPP:MView|:SView:ELENgth(?)

Selects or queries the eye length of the eye diagram in the main view or subview during the 3GPP-R5 modulation analysis. This command is valid when :DISPlay:DLR5_3GPP:MView|:SView:FORMat is set to SIEYe, SQEYe, or STEYe.

Syntax :DISPlay:DLR5_3GPP:MView|:SView:ELENgth <value>
 :DISPlay:DLR5_3GPP:MView|:SView:ELENgth?

Arguments <value>::=<NR1> specifies the eye length of the eye diagram.
 Range: 1 to 16.

Measurement Modes DEM DLR5_3G

Examples :DISPlay:DLR5_3GPP:MView:ELENgth 8
 sets the eye length to 8 in the main view.

Related Commands :DISPlay:DLR5_3GPP:MView|:SView:FORMat

:DISPlay:DLR5_3GPP:MView|:SVIew:FORMat(?)

Selects or queries the main view or subview display format in the 3GPP-R5 modulation analysis.

Syntax :DISPlay:DLR5_3GPP:MView|:SVIew:FORMat { OFF | CSGRam
| CPCCode | CPShortcode | CPSYmbol | CPTSlot | SCONste | SVEctor
| SEVM | SMERror | SPERror | SIEYe | SQEYe | STEYe | STABle
| CONSte | VECTor | SPECTrum }

:DISPlay:DLR5_3GPP:MView|:SVIew:FORMat?

Arguments Table 2-54 shows the arguments and display formats.

Table 2-54: 3GPP-R5 downlink modulation analysis display formats

Argument	Format
OFF	Hides all measurement results
CSGRam	Code domain power spectrogram
CPCCode	Code domain power versus channelization code
CPShortcode	Code domain power versus short code
CPSYmbol	Code domain power versus symbol
CPTSlot	Code domain power versus time slot
SCONste	Symbol constellation
SVEctor	Symbol vector
SEVM	Symbol EVM
SMERror	Symbol amplitude error
SPERror	Symbol phase error
SIEYe	Symbol eye diagram (vertical axis: I)
SQEYe	Symbol eye diagram (vertical axis: Q)
STEYe	Symbol trellis diagram (vertical axis: Phase)
STABle	Symbol table
CONSte	Constellation and modulation accuracy measurement results
VECTor	Vector locus
SPECTrum	Spectrum (subview only)

Measurement Modes DEMDLR5_3G

Examples :DISPlay:DLR5_3GPP:MVIew:FORMat CSGRam
displays the code domain power spectrogram in the main view.

:DISPlay:DLR5_3GPP:MView|:SVIew:POWer[:TOTa1](?)

Determines whether to display the total power for each time slot in the Code power versus Time slot view. This command is valid when :DISPlay :DLR5_3GPP:MView|:SVIew:FORMat is set to CPTSlot (Code power versus Time slot).

Syntax :DISPlay:DLR5_3GPP:MVIew|:SVIew:POWer[:TOTa1]
 { ON | OFF | 1 | 0 }

:DISPlay:DLR5_3GPP:MVIew|:SVIew:POWer[:TOTa1]?

Arguments OFF or 0 displays power of the channel specified with the :DISPlay :DLR5_3GPP:AVIew:CNUMBER command.

 ON or 1 displays the total power of all channels for each time slot.

Measurement Modes DEMDLR5_3G

Examples :DISPlay:DLR5_3GPP:MVIew:POWer:TOTa1 ON
displays the total power of all channels for each time slot in the main view.

Related Commands :DISPlay:DLR5_3GPP:MVIew|:SVIew:FORMat

:DISPlay:DLR5_3GPP:MView|:SVIew:POWer:SElect(?)

Selects or queries the channel to show the measured power in the Code power versus Time slot view. This command is valid when :DISPlay:DLR5_3GPP:MView|:SVIew:FORMat is set to CPTSlot (Code power versus Time slot).

Syntax :DISPlay:DLR5_3GPP:MView|:SVIew:POWer:SElect
 { CODE | PSCH | SSCH }
 :DISPlay:DLR5_3GPP:MView|:SVIew:POWer:SElect?

Arguments CODE shows the power of all channels or the specified channel, depending on the setting of the :DISPlay:DLR5_3GPP:MView|:SVIew:POWer[:TOTAl] command.
 PSCH shows the power of the P-SCH (Primary Synchronization Channel).
 SSCH shows the power of the S-SCH (Secondary Synchronization Channel).

Measurement Modes DEMDLR5_3G

Examples :DISPlay:DLR5_3GPP:MView:POWer:SElect SSCH
 shows the power of the S-SCH in the main view.

Related Commands :DISPlay:DLR5_3GPP:MView|:SVIew:FORMat,
 :DISPlay:DLR5_3GPP:MView|:SVIew:POWer[:TOTAl]

:DISPlay:DLR5_3GPP:MView|:SView:RADix(?)

Selects or queries the base of symbols on the main view or subview in the 3GPP-R5 modulation analysis. This command is valid when :DISPlay :DLR5_3GPP:MView|:SView:FORMat is STABle (symbol table).

Syntax :DISPlay:DLR5_3GPP:MView|:SView:RADix
 { BINary | OCTal | HEXadecimal }

 :DISPlay:DLR5_3GPP:MView|:SView:RADix?

Arguments BINary selects binary notation.

 OCTal selects octal notation.

 HEXadecimal selects hexadecimal notation.

Measurement Modes DEMDLR5_3G

Examples :DISPlay:DLR5_3GPP:MView:RADix BINary
 selects binary notation for the base of symbols in the main view.

Related Commands :DISPlay:DLR5_3GPP:MView|:SView:FORMat

:DISPlay:DLR5_3GPP:MView|:SVIew:ROTation(?)

Selects or queries the rotation of the symbol table in the main view or subview during the 3GPP-R5 modulation analysis. This command is valid when :DISPlay:DLR5_3GPP:MView|:SVIew:FORMat is set to STABLE (symbol table).

Syntax :DISPlay:DLR5_3GPP:MView|:SVIew:ROTation <value>
 :DISPlay:DLR5_3GPP:MView|:SVIew:ROTation?

Arguments <value>::=<NR1> specifies the rotation of the symbol table.
 Range: 0 to 3.

Measurement Modes DEMDLR5_3G

Examples :DISPlay:DLR5_3GPP:MView:ROTation 1
 sets the rotation to 1 in the main view.

Related Commands :DISPlay:DLR5_3GPP:MView|:SVIew:FORMat

:DISPlay:DLR5_3GPP:MView|:SVIew:X[:SCALe]:OFFSet(?)

Sets or queries the minimum horizontal value (left edge) on the main view or subview in the 3GPP-R5 modulation analysis.

Syntax :DISPlay:DLR5_3GPP:MVIEw|:SVIEw:X[:SCALe]:OFFSet <value>

 :DISPlay:DLR5_3GPP:MVIEw|:SVIEw:X[:SCALe]:OFFSet?

Arguments <value>::=<NRf> specifies the minimum horizontal value.
Refer to *Note on Horizontal Scaling* on page 2-184 for setting the scale.

Measurement Modes DEMDLR5_3G

Examples :DISPlay:DLR5_3GPP:MVIEw:X:SCALe:OFFSet 0
sets the minimum horizontal value to channel 0 when the main view displays a code domain power spectrogram.

Related Commands :DISPlay:DLR5_3GPP:MVIEw|:SVIEw:FORMat

:DISPlay:DLR5_3GPP:MView|:SVIew:X[:SCALe]:RANGe(?)

Sets or queries full-scale value of the horizontal axis in the main view or subview in the 3GPP-R5 modulation analysis.

Syntax :DISPlay:DLR5_3GPP:MVIEw|:SVIEw:X[:SCALe]:RANGe <value>

 :DISPlay:DLR5_3GPP:MVIEw|:SVIEw:X[:SCALe]:RANGe?

Arguments <value>::=<NRf> specifies full-scale value of the horizontal axis.
Refer to *Note on Horizontal Scaling* on page 2-184 for setting the scale.

Measurement Modes DEMDLR5_3G

Examples :DISPlay:DLR5_3GPP:MVIEw:X:SCALe:RANGe 512
sets the horizontal full-scale value to 512 channels when the main view displays a code domain power spectrogram.

Related Commands :DISPlay:DLR5_3GPP:MVIEw|:SVIEw:FORMat

:DISPlay:DLR5_3GPP:MView|:SVIew:Y[:SCALe]:FIT (No Query Form)

Runs auto-scale on the main view or subview in the 3GPP-R5 modulation analysis. The auto-scale automatically sets the start value and scale of the vertical axis to best display the waveform.

This command is valid when :DISPlay:DLR5_3GPP:MView|:SVIew:FORMat is CPSHortcode, CPSYmbol, CPTSlot, SEVM, SMERror, or SPERror.

Syntax :DISPlay:DLR5_3GPP:MView|:SVIew:Y[:SCALe]:FIT

Arguments None

Measurement Modes DEMDLR5_3G

Examples :DISPlay:DLR5_3GPP:MView|:SVIew:Y:SCALe:FIT
runs the auto-scale on the main view.

Related Commands :DISPlay:DLR5_3GPP:MView|:SVIew:FORMat

:DISPlay:DLR5_3GPP:MView|:SVIew:Y[:SCALe]:FULL (No Query Form)

Sets the main view or subview's vertical axis to the default full-scale value in the 3GPP-R5 modulation analysis.

This command is valid when :DISPlay:DLR5_3GPP:MView|:SVIew:FORMat is set to CPSHortcode, CPSYmbol, CPTSlot, SEVM, SMERror, or SPERror.

Syntax :DISPlay:DLR5_3GPP:MView|:SVIew:Y[:SCALe]:FULL

Arguments None

Measurement Modes DEMDLR5_3G

Examples :DISPlay:DLR5_3GPP:MView:Y:SCALe:FULL
sets the main view's vertical axis to the default full-scale value.

Related Commands :DISPlay:DLR5_3GPP:MView|:SVIew:FORMat

:DISPlay:DLR5_3GPP:MVlew|:SVlew:Y[:SCALe]:OFFSet(?)

Sets or queries the minimum vertical value (bottom) in the main view or subview in the 3GPP-R5 modulation analysis.

This command is valid when :DISPlay:DLR5_3GPP:MVlew|:SVlew:FORMat is set to CPHortcode, CPSYmbol, CPTSlot, SEVM, SMERror, or SPERror.

Syntax :DISPlay:DLR5_3GPP:MVlew|:SVlew:Y[:SCALe]:OFFSet <value>
 :DISPlay:DLR5_3GPP:MVlew|:SVlew:Y[:SCALe]:OFFSet?

Arguments <value>::=<NRf> specifies the minimum vertical value in the main view. The valid range depends on the display format. Refer to Table D-5 in *Appendix D*.

Measurement Modes DEMDLR5_3G

Examples :DISPlay:DLR5_3GPP:MVlew:Y:SCALe:OFFSet 0
 sets the bottom of the vertical axis to channel 0 when the main view displays a code domain power spectrogram.

Related Commands :DISPlay:DLR5_3GPP:MVlew|:SVlew:FORMat

:DISPlay:DLR5_3GPP:MView]:SVIew:Y[:SCALe]:PUNit(?)

Selects or queries the unit on the Y (color) axis in the main view or subview during the 3GPP-R5 modulation analysis.

This command is valid when :DISPlay:DLR5_3GPP:MView]:SVIew:FORMat is set to CSGRam, CPSHortcode, CPSYmbol, or CPTSlot.

Syntax :DISPlay:DLR5_3GPP:MView]:SVIew:Y[:SCALe]:PUNit
{ RELative | ABSolute }

:DISPlay:DLR5_3GPP:MView]:SVIew:Y[:SCALe]:PUNit?

Arguments RELative represents the relative channel power to the total power of all the channels along the Y axis in dB.

ABSolute represents the absolute power of each channel along the Y axis in dBm.

Measurement Modes DEMDLR5_3G

Examples :DISPlay:DLR5_3GPP:MView]:SVIew:Y:SCALe:PUNit RELative
represents the relative power along the Y axis in the main view.

Related Commands :DISPlay:DLR5_3GPP:MView]:SVIew:FORMat

:DISPlay:DLR5_3GPP:MView|:SVIew:Y[:SCALe]:RANGe(?)

Sets or queries full-scale value of the vertical axis in the main view or subview in the 3GPP-R5 modulation analysis.

This command is valid when :DISPlay:DLR5_3GPP:MView|:SVIew:FORMat is set to CSGRam, CPHortcode, CPSYmbol, CPTSlot, SEVM, SMERror, or SPERror.

Syntax :DISPlay:DLR5_3GPP:MView|:SVIew:Y[:SCALe]:RANGe <value>

:DISPlay:DLR5_3GPP:MView|:SVIew:Y[:SCALe]:RANGe?

Arguments <value>::=<NRf> specifies full-scale value of the vertical axis. The valid range depends on the display format. Refer to Table D-5 in *Appendix D*.

Measurement Modes DEMDLR5_3G

Examples :DISPlay:DLR5_3GPP:MView:Y:SCALe:RANGe 50
sets the vertical full-scale value to 50 slots when the main view displays a power codogram.

Related Commands :DISPlay:DLR5_3GPP:MView|:SVIew:FORMat

:DISPlay:SADLR5_3GPP|:SAULR5_3GPP Subgroup**3GPP-R5, Option 27 Only**

The :DISPlay:SADLR5_3GPP|:SAULR5_3GPP commands control display of the spectrum analysis of the channel power, ACLR, spectrum emission mask, EBW, OBW, and carrier frequency measurements under the 3GPP-R5 standard.

NOTE. To use a command in this group, you must have selected SADLR5_3G (3GPP-R5 downlink spectrum analysis) or SAULR5_3G (3GPP-R5 uplink spectrum analysis) using the :INSTRument[:SElect] command.

Command Tree	Header	Parameter
	:DISPlay	
	:SADLR5_3GPP :SAULR5_3GPP	
	:SPECTrum	
	:X	
	[:SCALE]	
	:OFFSet	
	:PDIVision	<frequency>
	:Y	
	[:SCALE]	
	:FIT	
	:FULL	
	:OFFSet	<amplitude>
	:PDIVision	<relative_amplitude>

:DISPlay:SADLR5_3GPP|:SAULR5_3GPP:SPECTrum:X[:SCALe]:OFFSet(?)

Sets or queries the minimum horizontal value (left edge) in the spectrum view.

Syntax :DISPlay:SADLR5_3GPP|:SAULR5_3GPP:SPECTrum:X[:SCALe]:OFFSet
 <value>

 :DISPlay:SADLR5_3GPP|:SAULR5_3GPP:SPECTrum:X[:SCALe]:OFFSet?

Arguments <value>::=<Nrf> specifies the minimum value of the horizontal axis.
 Range: Center frequency ± 25 MHz.
 Refer to *Note on Horizontal Scaling* on page 2-184 for setting the scale.

Measurement Modes SADLR5_3G, SAULR5_3G

Examples :DISPlay:SADLR5_3GPP:SPECTrum:X:SCALe:OFFSet 1GHz
 sets the minimum value of the horizontal axis to 1 GHz.

:DISPlay:SADLR5_3GPP|:SAULR5_3GPP:SPECTrum:X[:SCALe]:PDIVision(?)

Sets or queries the horizontal, or frequency, scale (per division) in the spectrum view.

Syntax :DISPlay:SADLR5_3GPP|:SAULR5_3GPP:SPECTrum:X[:SCALe]:PDIVision
 <value>

 :DISPlay:SADLR5_3GPP|:SAULR5_3GPP:SPECTrum:X[:SCALe]:PDIVision?

Arguments <value>::=<Nrf> specifies the horizontal scale (per division).
 Range: 0 to 2.5 MHz.
 Refer to *Note on Horizontal Scaling* on page 2-184 for setting the scale.

Measurement Modes SADLR5_3G, SAULR5_3G

Examples :DISPlay:SADLR5_3GPP:SPECTrum:X:SCALe:PDIVision 2.5MHz
 sets the horizontal scale to 2.5 MHz/div.

:DISPlay:SADLR5_3GPP|SAULR5_3GPP:SPECTrum:Y[:SCALe]:FIT (No Query Form)

Runs auto-scale on the spectrum view. The auto-scale automatically sets the start value and scale of the vertical axis to best display the waveform.

Syntax :DISPlay:SADLR5_3GPP|SAULR5_3GPP:SPECTrum:Y[:SCALe]:FIT

Arguments None

Measurement Modes SADLR5_3G, SAULR5_3G

Examples :DISPlay:SADLR5_3GPP:SPECTrum:Y:SCALe:FIT
runs the auto-scale on the spectrum view.

:DISPlay:SADLR5_3GPP|SAULR5_3GPP:SPECTrum:Y[:SCALe]:FULL (No Query Form)

Sets the vertical axis to the default full-scale value in the spectrum view.

Syntax :DISPlay:SADLR5_3GPP|SAULR5_3GPP:SPECTrum:Y[:SCALe]:FULL

Arguments None

Measurement Modes SADLR5_3G, SAULR5_3G

Examples :DISPlay:SADLR5_3GPP:SPECTrum:Y:SCALe:FULL
sets the vertical axis to the default full-scale value in the spectrum view.

:DISPlay:SADLR5_3GPP|:SAULR5_3GPP:SPECTrum:Y[:SCALe]:OFFSet(?)

Queries the minimum vertical value (bottom) on the spectrum view.

Syntax :DISPlay:SADLR5_3GPP|:SAULR5_3GPP:SPECTrum:Y[:SCALe]:OFFSet
 <value>

:DISPlay:SADLR5_3GPP|:SAULR5_3GPP:SPECTrum:Y[:SCALe]:OFFSet?

Arguments <value>::=<NRf> sets the minimum vertical value. Range: -200 to +100 dBm.

Measurement Modes SADLR5_3G

Examples :DISPlay:SADLR5_3GPP:Y:SCALe:OFFSet -100
 sets the minimum vertical value to -100 dBm.

:DISPlay:SADLR5_3GPP|:SAULR5_3GPP:SPECTrum:Y[:SCALe]:PDIVision(?)

Sets or queries the vertical, or amplitude, scale (per division) in the spectrum view.

Syntax :DISPlay:SADLR5_3GPP|:SAULR5_3GPP:SPECTrum:Y[:SCALe]:PDIVision
 <value>

:DISPlay:SADLR5_3GPP|:SAULR5_3GPP:SPECTrum:Y[:SCALe]:PDIVision?

Arguments <value>::=<NRf> sets the vertical scale (per division). Range: 0 to 10 dB.

Measurement Modes SADLR5_3G

Examples :DISPlay:SADLR5_3GPP:Y:SCALe:PDIVision 10
 sets the full-scale value of the vertical axis to 10 dB/div.

:DISPlay:ULR5_3GPP Subgroup**3GPP-R5, Option 27 Only**

The :DISPlay:ULR5_3GPP commands control display of the 3GPP-R5 uplink modulation analysis.

NOTE. To use a command from this group, you must have selected *DEMULR5_3G* (3GPP-R5 uplink modulation analysis) in the *:INSTrument[:SElect]* command.

Command Tree	Header	Parameter
	:DISPlay	
	:ULR5_3GPP	
	:AVIEW	
	:CNUMBER	<number>
	:SRATE	R960S R480S R240S R120S R60S R30S R15S
	:TSLot	<number>
	:MVIEW :SVIEW	
	:COLor	
	[:SCALE]	
	:OFFSet	<amplitude>
	:RANge	<relative_amplitude>
	:ELENgth	<numeric_value>
	:FORMat	OFF ANACK CSGRam CPCNumber CPSymbol CPTSlot SCONste SVECTOR SEVM SMERror SPERror SIEYe SQEYe STEYe STABLE CONSte VECTOR SPECTrum
	:POWER	
	[:TOTal]	<boolean>
	:RADix	BINary OCTal HEXadecimal
	:ROTation	<numeric_value>
	:X	
	[:SCALE]	
	:OFFSet	<numeric_value>
	:RANge	<numeric_value>
	:Y	
	[:SCALE]	
	:FIT	
	:FULL	
	:OFFSet	<numeric_value>
	:PUNit	RELative ABSolute
	:RANge	<numeric_value>

:DISPlay:ULR5_3GPP:AVIew:CNUMber(?)

Sets or queries the channel number to position the marker in the 3GPP-R5 uplink modulation analysis.

Syntax :DISPlay:ULR5_3GPP:AVIew:CNUMber <number>
 :DISPlay:ULR5_3GPP:AVIew:CNUMber?

Arguments <number>::=<NR1> specifies the channel number.
 Range: Channel 0 to 7.

Measurement Modes DEMULR5_3G

Examples :DISPlay:ULR5_3GPP:AVIew:CNUMber 5
 sets the channel number to 5 to position the marker.

:DISPlay:ULR5_3GPP:AVIew:SRATe(?)

Sets or queries the symbol rate for the measurement in the 3GPP-R5 uplink modulation analysis.

Syntax :DISPlay:ULR5_3GPP:AVIew:SRATe { R960S | R480S | R240S | R120S
| R60S | R30S | R15S }
:DISPlay:ULR5_3GPP:AVIew:SRATe?

Arguments The arguments specify the symbol rates as listed below:

Table 2-55: Symbol rate settings

Argument	Symbol rate
R960S	960 k
R480S	480 k
R240S	240 k
R120S	120 k
R60S	60 k
R30S	30 k
R15S	15 k

Measurement Modes DEMULR5_3G

Examples :DISPlay:ULR5_3GPP:AVIew:SRATe R960S
sets the symbol rate to 960 k.

:DISPlay:ULR5_3GPP:AVIew:TSLot(?)

Sets or queries the number of the time slot to be displayed in the 3GPP-R5 modulation analysis.

Syntax :DISPlay:ULR5_3GPP:AVIew:TSLot <number>

:DISPlay:ULR5_3GPP:AVIew:TSLot?

Arguments <number>: :=<NR1> specifies the number of the time slot to be displayed.
Range: Slot -15999 to 0.

Measurement Modes DEMULR5_3G

Examples :DISPlay:ULR5_3GPP:AVIew:TSLot -100
sets the time slot number to -100.

:DISPlay:ULR5_3GPP:MView|:SVIew:COLor[:SCALe]:OFFSet(?)

Sets or queries the minimum value on the color, or amplitude, axis when the view displays a spectrogram in the 3GPP-R5 modulation analysis.

Syntax :DISPlay:ULR5_3GPP:MView|:SVIew:COLor[:SCALe]:OFFSet <value>
:DISPlay:ULR5_3GPP:MView|:SVIew:COLor[:SCALe]:OFFSet?

Arguments <value>::=<NRf> specifies the minimum value on the color axis.
Range: -100 to 0 dBm.

Measurement Modes DEMULR5_3G

Examples :DISPlay:ULR5_3GPP:MView:COLor:SCALe:OFFSet -100
sets the minimum value on the color axis in the main view to -100 dBm.

Related Commands :DISPlay:ULR5_3GPP:MView|:SVIew:FORMat

:DISPlay:ULR5_3GPP:MView|:SVIew:COLor[:SCALe]:RANGe(?)

Sets or queries full-scale value of the color, or amplitude, axis when the view displays a spectrogram in the 3GPP-R5 modulation analysis.

Syntax :DISPlay:ULR5_3GPP:MView|:SVIew:COLor[:SCALe]:RANGe <value>
:DISPlay:ULR5_3GPP:MView|:SVIew:COLor[:SCALe]:RANGe?

Arguments <value>::={ 5 | 10 | 20 | 50 } [dB] specifies full-scale value of the color axis in the spectrogram view.

Measurement Modes DEMULR5_3G

Examples :DISPlay:ULR5_3GPP:MView:COLor:SCALe:RANGe 50
sets full-scale value of the color axis to 50 dB.

Related Commands :DISPlay:ULR5_3GPP:MView|:SVIew:FORMat

:DISPlay:ULR5_3GPP:MView|:SView:ELENgth(?)

Selects or queries the eye length of the eye diagram in the main view or subview during the 3GPP-R5 modulation analysis. This command is valid when :DISPlay:ULR5_3GPP:MView|:SView:FORMat is set to SIEYe, SQEYe, or STEYe.

Syntax :DISPlay:ULR5_3GPP:MView|:SView:ELENgth <value>
 :DISPlay:ULR5_3GPP:MView|:SView:ELENgth?

Arguments <value>::=<NR1> specifies the eye length of the eye diagram.
 Range: 1 to 16.

Measurement Modes DEMULR5_3G

Examples :DISPlay:ULR5_3GPP:MView:ELENgth 8
 sets the eye length to 8 in the main view.

Related Commands :DISPlay:ULR5_3GPP:MView|:SView:FORMat

:DISPlay:ULR5_3GPP:MView|:SVIew:FORMat(?)

Selects or queries the main view or subview display format in the 3GPP-R5 modulation analysis.

Syntax :DISPlay:ULR5_3GPP:MView|:SVIew:FORMat { OFF | ANACK | CSGRam
| CPCNumber | CPSYmbol | CPTSlot | SCONste | SVEctor
| SEVM | SMERror | SPERror | SIEYe | SQEYe | STEYe
| STABLE | CONSte | VECTor | SPECTrum }
:DISPlay:ULR5_3GPP:MView|:SVIew:FORMat?

Arguments Table 2-54 shows the arguments and display formats.

Table 2-56: 3GPP-R5 uplink modulation analysis display formats

Argument	Format
OFF	Hides all measurement results
ANACK	ACK/NACK
CSGRam	Code domain power spectrogram
CPCNumber	Code domain power versus channelization code
CPSYmbol	Code domain power versus symbol
CPTSlot	Code domain power versus time slot
SCONste	Symbol constellation
SVEctor	Symbol vector
SEVM	Symbol EVM
SMERror	Symbol amplitude error
SPERror	Symbol phase error
SIEYe	Symbol eye diagram (vertical axis: I)
SQEYe	Symbol eye diagram (vertical axis: Q)
STEYe	Symbol trellis diagram (vertical axis: Phase)
STABLE	Symbol table
CONSte	Constellation and modulation accuracy measurement results
VECTor	Vector locus
SPECTrum	Spectrum (subview only)

Measurement Modes DEMULR5_3G

Examples :DISPlay:ULR5_3GPP:MVIew:FORMat CSGRam
displays the code domain power spectrogram in the main view.

:DISPlay:ULR5_3GPP:MVIew|:SVIew:POWer[:TOTa1](?)

Determines whether to display the total power for each time slot in the Code power versus Time slot view. This command is valid when :DISPlay :ULR5_3GPP:MVIew|:SVIew:FORMat is set to CPTSlot (Code power versus Time slot).

Syntax :DISPlay:ULR5_3GPP:MVIew|:SVIew:POWer[:TOTa1]
 { ON | OFF | 1 | 0 }

:DISPlay:ULR5_3GPP:MVIew|:SVIew:POWer[:TOTa1]?

Arguments OFF or 0 displays power of the channel specified with the :DISPlay :ULR5_3GPP:AVIew:CNUMber command.

ON or 1 displays the total power of all channels for each time slot.

Measurement Modes DEMULR5_3G

Examples :DISPlay:ULR5_3GPP:MVIew:POWer:TOTa1 ON
displays the total power of all channels for each time slot in the main view.

Related Commands :DISPlay:ULR5_3GPP:MVIew|:SVIew:FORMat,
:DISPlay:ULR5_3GPP:AVIew:CNUMber

:DISPlay:ULR5_3GPP:MView|:SVIew:RADix(?)

Selects or queries the base of symbols on the main view or subview during the 3GPP-R5 modulation analysis. This command is valid when :DISPlay:ULR5_3GPP:MView|:SVIew:FORMat is STABLE (symbol table).

Syntax :DISPlay:ULR5_3GPP:MView|:SVIew:RADix
 { BINary | OCTal | HEXadecimal }
 :DISPlay:ULR5_3GPP:MView|:SVIew:RADix?

Arguments BINary selects binary notation.
 OCTal selects octal notation.
 HEXadecimal selects hexadecimal notation.

Measurement Modes DEMULR5_3G

Examples :DISPlay:ULR5_3GPP:MView:RADix BINary
 selects binary notation for the base of symbols in the main view.

Related Commands :DISPlay:ULR5_3GPP:MView|:SVIew:FORMat

:DISPlay:ULR5_3GPP:MView|:SView:ROtation(?)

Selects or queries the rotation of the symbol table in the main view or subview during the 3GPP-R5 modulation analysis. This command is valid when :DISPlay:ULR5_3GPP:MView|:SView:FORMat is set to STABLE (symbol table).

Syntax :DISPlay:ULR5_3GPP:MView|:SView:ROtation <value>
 :DISPlay:ULR5_3GPP:MView|:SView:ROtation?

Arguments <value>::=<NR1> specifies the rotation of the symbol table.
 Range: 0 to 3.

Measurement Modes DEMULR5_3G

Examples :DISPlay:ULR5_3GPP:MView:ROtation 1
 sets the rotation to 1 in the main view.

Related Commands :DISPlay:ULR5_3GPP:MView|:SView:FORMat

:DISPlay:ULR5_3GPP:MView|:SVIew:X[:SCALe]:OFFSet(?)

Sets or queries the minimum horizontal value (left edge) on the main view or subview in the 3GPP-R5 modulation analysis.

Syntax :DISPlay:ULR5_3GPP:MView|:SVIew:X[:SCALe]:OFFSet <value>
:DISPlay:ULR5_3GPP:MView|:SVIew:X[:SCALe]:OFFSet?

Arguments <value>::=<NRf> specifies the minimum horizontal value.
Refer to *Note on Horizontal Scaling* on page 2-184 for setting the scale.

Measurement Modes DEMULR5_3G

Examples :DISPlay:ULR5_3GPP:MView:X:SCALe:OFFSet 0
sets the minimum horizontal value to channel 0 when the main view displays a code domain power spectrogram.

Related Commands :DISPlay:ULR5_3GPP:MView|:SVIew:FORMat

:DISPlay:ULR5_3GPP:MView|:SVIew:X[:SCALe]:RANGe(?)

Sets or queries full-scale value of the horizontal axis in the main view or subview in the 3GPP-R5 modulation analysis.

Syntax :DISPlay:ULR5_3GPP:MView|:SVIew:X[:SCALe]:RANGe <value>
:DISPlay:ULR5_3GPP:MView|:SVIew:X[:SCALe]:RANGe?

Arguments <value>::=<NRf> specifies full-scale value of the horizontal axis.
Refer to *Note on Horizontal Scaling* on page 2-184 for setting the scale.

Measurement Modes DEMULR5_3G

Examples :DISPlay:ULR5_3GPP:MView:X:SCALe:RANGe 512
sets the horizontal full-scale value to 512 channels when the main view displays a code domain power spectrogram.

Related Commands :DISPlay:ULR5_3GPP:MView|:SVIew:FORMat

:DISPlay:ULR5_3GPP:MView|:SVIew:Y[:SCALe]:FIT (No Query Form)

Runs auto-scale on the main view or subview in the 3GPP-R5 modulation analysis. The auto-scale automatically sets the start value and scale of the vertical axis to best display the waveform.

This command is valid when :DISPlay:ULR5_3GPP:MView|:SVIew:FORMat is CPHortcode, CPSYmbol, CPTSlot, SEVM, SMERror, or SPERror.

Syntax :DISPlay:ULR5_3GPP:MView|:SVIew:Y[:SCALe]:FIT

Arguments None

Measurement Modes DEMULR5_3G

Examples :DISPlay:ULR5_3GPP:MView|:SVIew:Y:SCALe:FIT
runs the auto-scale on the main view.

Related Commands :DISPlay:ULR5_3GPP:MView|:SVIew:FORMat

:DISPlay:ULR5_3GPP:MView|:SVIew:Y[:SCALe]:FULL (No Query Form)

Sets the main view or subview's vertical axis to the default full-scale value in the 3GPP-R5 modulation analysis.

This command is valid when :DISPlay:ULR5_3GPP:MView|:SVIew:FORMat is set to CPHortcode, CPSYmbol, CPTSlot, SEVM, SMERror, or SPERror.

Syntax :DISPlay:ULR5_3GPP:MView|:SVIew:Y[:SCALe]:FULL

Arguments None

Measurement Modes DEMULR5_3G

Examples :DISPlay:ULR5_3GPP:MView:Y:SCALe:FULL
sets the main view's vertical axis to the default full-scale value.

Related Commands :DISPlay:ULR5_3GPP:MView|:SVIew:FORMat

:DISPlay:ULR5_3GPP:MView|:SVIew:Y[:SCALe]:OFFSet(?)

Sets or queries the minimum vertical value (bottom) in the main view or subview in the 3GPP-R5 modulation analysis.

This command is valid when :DISPlay:ULR5_3GPP:MView|:SVIew:FORMat is set to CPShortcode, CPSSymbol, CPSSlot, SEVM, SMERror, or SPERror.

Syntax :DISPlay:ULR5_3GPP:MView|:SVIew:Y[:SCALe]:OFFSet <value>
:DISPlay:ULR5_3GPP:MView|:SVIew:Y[:SCALe]:OFFSet?

Arguments <value>::=<Nrf> specifies the minimum vertical value in the main view. The valid range depends on the display format. Refer to Table D-5 in *Appendix D*.

Measurement Modes DEMULR5_3G

Examples :DISPlay:ULR5_3GPP:MView:Y:SCALe:OFFSet 0
sets the bottom of the vertical axis to channel 0 when the main view displays a code domain power spectrogram.

Related Commands :DISPlay:ULR5_3GPP:MView|:SVIew:FORMat

:DISPlay:ULR5_3GPP:MVIew|:SVIew:Y[:SCALe]:PUNit(?)

Selects or queries the unit on the Y (color) axis in the main view or subview during the 3GPP-R5 modulation analysis.

This command is valid when :DISPlay:ULR5_3GPP:MVIew|:SVIew:FORMat is set to CSGRam, CPSHortcode, CPSYmbol, or CPTSlot.

Syntax :DISPlay:ULR5_3GPP:MVIew|:SVIew:Y[:SCALe]:PUNit
 { RELative | ABSolute }

:DISPlay:ULR5_3GPP:MVIew|:SVIew:Y[:SCALe]:PUNit?

Arguments RELative represents the relative channel power to the total power of all the channels along the Y axis in dB.

ABSolute represents the absolute power of each channel along the Y axis in dBm.

Measurement Modes DEMULR5_3G

Examples :DISPlay:ULR5_3GPP:MVIew|:SVIew:Y:SCALe:PUNit RELative
 represents the relative power along the Y axis in the main view.

Related Commands :DISPlay:ULR5_3GPP:MVIew|:SVIew:FORMat

:DISPlay:ULR5_3GPP:MView|:SVIew:Y[:SCALe]:RANGe(?)

Sets or queries full-scale value of the vertical axis in the main view or subview in the 3GPP-R5 modulation analysis.

This command is valid when :DISPlay:ULR5_3GPP:MView|:SVIew:FORMat is set to CSGRam, CPShortcode, CPSSymbol, CPtSlot, SEVM, SMERror, or SPERror.

Syntax :DISPlay:ULR5_3GPP:MView|:SVIew:Y[:SCALe]:RANGe <value>

:DISPlay:ULR5_3GPP:MView|:SVIew:Y[:SCALe]:RANGe?

Arguments <value>::=<Nrf> specifies full-scale value of the vertical axis. The valid range depends on the display format. Refer to Table D-5 in *Appendix D*.

Measurement Modes DEMULR5_3G

Examples :DISPlay:ULR5_3GPP:MView:Y:SCALe:RANGe 50
sets the vertical full-scale value to 50 slots when the main view displays a power codogram.

Related Commands :DISPlay:ULR5_3GPP:MView|:SVIew:FORMat

:DISPlay:TD_SCDMA:DDEMod Subgroup

TD-SCDMA Analysis, Option 28 Only

The :DISPlay:TD_SCDMA:DDEMod commands control display of the main view and subview for the digital modulation related measurement under TD-SCDMA standard.

NOTE. To use a command from this group, you must have selected *DEMTD_SCDMA (TD-SCDMA analysis)* in the *:INSTRument[:SElect]* command.

Command Tree	Header	Parameter
	:DISPlay	
	:TD_SCDMA	
	:DDEMod	
	:MView	
	:FORMat	MACCuracy SCONste EVM MERRor PERRor CDPower CVSFrame CVSYmbol PCGRam TPVTime LPVTime SPVTime STable
	:RADix	BINary OCTal HEXadecimal
	:X	
	[:SCALE]	
	:OFFSet	<numeric_value>
	:PDIVision	<numeric_value>
	:RANGe	<numeric_value>
	:Y	
	[:SCALE]	
	:FIT	
	:FULL	
	:OFFSet	<numeric_value>
	:PDIVision	<numeric_value>
	:PUNit	RELative ABSolute
	:RANGe	<numeric_value>
	:ZOOM	
	:MCONtrol	
	[:START]	
	:END	
	:MRPower	<numeric_value>
	:OPower	<numeric_value>
	:TSlot	
	[:START]	

```

:SVIEW
:FORMat      SPECTrum | MACCuracy | SCONste
              | EVM | MERRor | PERRor
              | CDPower | CVSFrame | CVSYmbol
              | PCGRam | TPVTime | LPVTime
              | SPVTime | STable
:RADix      BINary | OCTal | HEXadecimal
:X
  [:SCALE]
  :OFFSet    <numeric_value>
  :PDIVision <numeric_value>
  :RANGe     <numeric_value>
:Y
  [:SCALE]
  :FIT
  :FULL
  :OFFSet    <numeric_value>
  :PDIVision RELative | ABSolute
  :PUNit     RELative | ABSolute
  :RANGe     <numeric_value>
:ZOOM
:MCONtrol
  [:START]
  :END
:TSLot
  [:START]

```

:DISPlay:TD_SCDMA:DDEMod:MVlew:FORMat(?)

Selects or queries the display format of the main view in the digital modulation related measurement.

Syntax :DISPlay:TD_SCDMA:DDEMod:MVlew:FORMat { MACCuracy | SCONste | EVM | MERRor | PERRor | CDPower | CVSFrame | CVSYmbol | PCGRam | TPVTime | LPVTime | SPVTime | STABle }

:DISPlay:TD_SCDMA:DDEMod:MVlew:FORMat?

Arguments The arguments and display formats are listed below:

Argument	Display format
MACCuracy	Modulation accuracy
SCONste	Symbol constellation
EVM	Error vector magnitude (EVM)
MERRor	Amplitude (magnitude) error
PERRor	Phase error
CDPower	Code domain power
CVSFrame	Code domain power versus subframe
CVSYmbol	Code domain power versus symbol
PCGRam	Power codogram
TPVTime	Timeslot power versus time
SPVTime	Subframe power versus time
STABle	Symbol table

NOTE. The arguments *CDPower* and *PCGRam* are available only when the *[[:SENSe]:TD_SCDMA:MEASurement]* command is set to *CDPower*. The arguments *MACCuracy*, *EVM*, *MERRor*, *PERRor*, and *STABle* are available only when the *[[:SENSe]:TD_SCDMA:MEASurement]* command is set to *MACCuracy*.

Measurement Modes DEMTD_SCDMA

Examples :DISPlay:TD_SCDMA:DDEMod:MVIew:FORMat CDPower
selects the code domain power measurement under the TD-SCDMA standard.

Related Commands :DISPlay:TD_SCDMA:DDEMod:SVIew:FORMat
[:SENSe]:TD_SCDMA:MEASurement

:DISPlay:TD_SCDMA:DDEMod:MVIew:RADix(?)

Sets or queries the base of symbols on the main view during the TD-SCDMA analysis. This command is valid when :DISPlay:TD_SCDMA:DDEMod:MVIew:FORMat is set to STABLE.

Syntax :DISPlay:TD_SCDMA:DDEMod:MVIew:RADix { BINary | OCTal
| HEXadecimal }

:DISPlay:TD_SCDMA:DDEMod:MVIew:RADix?

Arguments The arguments and base display are listed below:

Argument	Base
BINary	Binary notation
OCTal	Octal notation
HEXadecimal	Hexadecimal notation

Measurement Modes DEMTD_SCDMA

Examples :DISPlay:TD_SCDMA:DDEMod:MVIew:RADix BINary
sets the main view display to show the symbols in binary under the TD-SCDMA standard.

:DISPlay:TD_SCDMA:DDEMod:MVlew:X[:SCALE]:OFFSet(?)

Sets or queries the minimum horizontal value (left edge) in the main view during the digital modulation related measurement.

NOTE. This command is not available when `:DISPlay:TD_SCDMA:DDEMod:MVlew:FORMat` is set to `MACCuracy`.

Syntax `:DISPlay:TD_SCDMA:DDEMod:MVlew:X[:SCALE]:OFFset <numeric_value>`
`:DISPlay:TD_SCDMA:DDEMod:MVlew:X[:SCALE]:OFFset?`

Arguments `<numeric_value>::=<NRf>` specifies the minimum horizontal value in the main view. Refer to *Note on Horizontal Scaling* on page 2-184 for setting the scale.

Measurement Modes `DEMTD_SCDMA`

Examples `:DISPlay:TD_SCDMA:DDEMod:MVlew:X:SCALE:OFFSet 10`
sets the minimum horizontal value to 10 chips when the main view displays EVM under the TD-SCDMA standard.

Related Commands `:DISPlay:TD_SCDMA:DDEMod:MVlew:FORMat`

:DISPlay:TD_SCDMA:DDEMod:MVIew:X[:SCALe]:PDIVision(?)

Sets or queries the horizontal, or time, scale (per division) in the main view. This command is valid when :DISPlay:TD_SCDMA:DDEMod:MVIew:FORMat is set to TPVTime, LPVTime, or SPVTime.

Syntax :DISPlay:TD_SCDMA:DDEMod:MVIew:X[:SCALe]:PDIVision
<numeric_value>
:DISPlay:TD_SCDMA:DDEMod:MVIew:X[:SCALe]:PDIVision?

Arguments <numeric_value>::=<NRF> specifies the horizontal scale in the main view. Refer to *Note on Horizontal Scaling* on page 2-184 for setting the scale.

Measurement Modes DEMTD_SCDMA

Examples :DISPlay:TD_SCDMA:DDEMod:MVIew:X:SCALe:PDIVision 1us
sets the horizontal scale to 1 ms/div in the main view under the TD-SCDMA standard.

:DISPlay:TD_SCDMA:DDEMod:MVlew:X[:SCALE]:RANGe(?)

Sets or queries the full-scale value of the horizontal axis in the main view during the digital modulation related measurement.

NOTE. This command is not available when `:DISPlay:TD_SCDMA:DDEMod:MVlew:FORMat` is set to `MACCuracy`.

Syntax `:DISPlay:TD_SCDMA:DDEMod:MVlew:X[:SCALE]:RANGe <numeric_value>`
`:DISPlay:TD_SCDMA:DDEMod:MVlew:X[:SCALE]:RANGe?`

Arguments `<numeric_value>::=<NRf>` specifies the full-scale value of the horizontal axis in the main view. Refer to *Note on Horizontal Scaling* on page 2-184 for setting the scale.

Measurement Modes `DEMTD_SCDMA`

Examples `:DISPlay:TD_SCDMA:DDEMod:MVlew:X:SCALE:RANGe 512`
sets the full-scale value of the horizontal axis to 512 chips when the main view displays EVM under the TD-SCDMA standard.

Related Commands `:DISPlay:TD_SCDMA:DDEMod:MVlew:FORMat`

:DISPlay:TD_SCDMA:DDEMod:MView:Y[:SCALE]:FIT (No Query Form)

Runs auto-scale on the main view during the digital modulation related measurement. The auto-scale automatically sets the start value and scale of the vertical axis so that the whole waveform is displayed on the screen.

Syntax :DISPlay:TD_SCDMA:DDEMod:MView:Y[:SCALE]:FIT

Arguments None

Measurement Modes DEMTD_SCDMA

Examples :DISPlay:TD_SCDMA:DDEMod:MView:Y:SCALE:FIT
runs auto-scale on the main view under the TD-SCDMA standard.

Related Commands :DISPlay:TD_SCDMA:DDEMod:MView:FORMat

:DISPlay:TD_SCDMA:DDEMod:MView:Y[:SCALE]:FULL (No Query Form)

Sets the vertical axis in the main view to the default full-scale value during the digital modulation related measurement.

Syntax :DISPlay:TD_SCDMA:DDEMod:MView:Y[:SCALE]:FULL

Arguments None

Measurement Modes DEMTD_SCDMA

Examples :DISPlay:TD_SCDMA:DDEMod:MView:Y:SCALE:FULL
sets the main view's vertical axis to the default full-scale value under the TD-SCDMA standard.

Related Commands :DISPlay:TD_SCDMA:DDEMod:MView:FORMat

:DISPlay:TD_SCDMA:DDEMod:MView:Y[:SCALE]:OFFSet(?)

Sets or queries the minimum vertical value in the main view (bottom) during the digital modulation related measurement.

Syntax :DISPlay:TD_SCDMA:DDEMod:MView:Y[:SCALE]:OFFSet <numeric_value>
:DISPlay:TD_SCDMA:DDEMod:MView:Y[:SCALE]:OFFSet?

Arguments <numeric_value>::=<Nrf> specifies the minimum vertical value in the main view. The valid range depends on the display format. Refer to Table D-8 in *Appendix D*.

Measurement Modes DEMTD_SCDMA

Examples :DISPlay:TD_SCDMA:DDEMod:MView:Y:SCALE:OFFSet -1mPCT
sets the minimum vertical value to -1m% when the main view displays EVM under the TD-SCDMA standard.

Related Commands :DISPlay:TD_SCDMA:DDEMod:MView:FORMat

:DISPlay:TD_SCDMA:DDEMod:MView:Y[:SCALE]:PDIVision(?)

Sets or queries the vertical, or power, scale (per division) in the main view. This command is valid when :DISPlay:TD_SCDMA:DDEMod:MView:FORMat is set to TPVTime, LPVTime, or SPVTime.

Syntax :DISPlay:TD_SCDMA:DDEMod:MView:Y[:SCALE]:PDIVision
<numeric_value>
:DISPlay:TD_SCDMA:DDEMod:MView:Y[:SCALE]:PDIVision?

Arguments <numeric_value>::=<Nrf> specifies the vertical scale in the main view.

Measurement Modes DEMTD_SCDMA

Examples :DISPlay:TD_SCDMA:DDEMod:MView:Y[:SCALE]:PDIVision 1dBm
sets the vertical scale to 1 dBm/div in the main view under the TD-SCDMA standard.

:DISPlay:TD_SCDMA:DDEMod:MView:Y[:SCALe]:PUNit(?)

Selects or queries the unit on the Y, or power, axis in the main view during the digital modulation related measurement. This command is valid when :DISPlay:TD_SCDMA:DDEMod:MView:FORMat is set to CDPower, CVSYmbol, or CVSFrame.

Syntax :DISPlay:TD_SCDMA:DDEMod:MView:Y[:SCALe]:PUNit
{ RELative | ABSolute }
:DISPlay:TD_SCDMA:DDEMod:MView:Y[:SCALe]:PUNit?

Arguments RELative represents the relative channel power to the total power of all the channels along the Y axis in dB.
ABSolute represents the absolute power of each channel along the Y axis in dBm.

Measurement Modes DEMTD_SCDMA

Examples :DISPlay:TD_SCDMA:DDEMod:MView:Y:SCALe:PUNit ABSolute
sets the Y axis unit in the main view to Absolute under the TD-SCDMA standard.

Related Commands :DISPlay:TD_SCDMA:DDEMod:MView:FORMat

:DISPlay:TD_SCDMA:DDEMod:MVIew:Y[:SCALE]:RANGe(?)

Sets or queries the full-scale value of the vertical axis in the main view during the digital modulation related measurement.

Syntax :DISPlay:TD_SCDMA:DDEMod:MVIew:Y[:SCALE]:RANGe <numeric_value>
 :DISPlay:TD_SCDMA:DDEMod:MVIew:Y[:SCALE]:RANGe?

Arguments <numeric_value>::=<NRf> specifies the full-scale value of the vertical axis in the main view. The valid range depends on the display format. Refer to Table D-8 in *Appendix D*.

Measurement Modes DEMTD_SCDMA

Examples :DISPlay:TD_SCDMA:DDEMod:MVIew:Y:SCALE:RANGe 10PCT
 sets the full-scale value of the vertical axis to 10% when the main view displays EVM under the TD-SCDMA standard.

Related Commands :DISPlay:TD_SCDMA:DDEMod:MVIew:FORMat

:DISPlay:TD_SCDMA:DDEMod:MView:ZOOM:MCONtrol[:START] (No Query Form)

Sets the zoom to the transmit mask start in the main view during the digital modulation related measurement. This command is valid when :DISPlay:TD_SCDMA:DDEMod:MView:FORMat is set to LPVTime.

Syntax :DISPlay:TD_SCDMA:DDEMod:MView:ZOOM:MCONtrol[:START]

Arguments None

Measurement Modes DEMTD_SCDMA

Examples :DISPlay:TD_SCDMA:DDEMod:MView:ZOOM:MCONtrol:START
Sets the zoom to the transmit mask start.

:DISPlay:TD_SCDMA:DDEMod:MView:ZOOM:MCONtrol:END (No Query Form)

Sets the zoom to the transmit mask end in the main view during the digital modulation related measurement. This command is valid when :DISPlay:TD_SCDMA:DDEMod:MView:FORMat is set to LPVTime.

Syntax :DISPlay:TD_SCDMA:DDEMod:MView:ZOOM:MCONtrol:END

Arguments None

Measurement Modes DEMTD_SCDMA

Examples :DISPlay:TD_SCDMA:DDEMod:MView:ZOOM:MCONtrol:END
Sets the zoom to the transmit mask end.

:DISPlay:TD_SCDMA:DDEMod:MVlew:ZOOM:MCONtrol:MRPower (No Query Form)

Sets the zoom to the maximum transmit mid-ramp power in the main view during the digital modulation related measurement. This command is valid only when :DISPlay:TD_SCDMA:DDEMod:MVlew:FORMat is set to LPVTime.

Syntax :DISPlay:TD_SCDMA:DDEMod:MVlew:ZOOM:MCONtrol:MRPower

Arguments None

Measurement Modes DEMTD_SCDMA

Examples :DISPlay:TD_SCDMA:DDEMod:MVlew:ZOOM:MCONtrol:MRPower
Sets the zoom to the maximum transmit mid-ramp power

:DISPlay:TD_SCDMA:DDEMod:MVlew:ZOOM:MCONtrol:OPower (No Query Form)

Sets the zoom to the maximum transmit off power in the main view during the digital modulation related measurement. This command is valid only when :DISPlay:TD_SCDMA:DDEMod:MVlew:FORMat is set to LPVTime.

Syntax :DISPlay:TD_SCDMA:DDEMod:MVlew:ZOOM:MCONtrol:OPower

Arguments None

Measurement Modes DEMTD_SCDMA

Examples :DISPlay:TD_SCDMA:DDEMod:MVlew:ZOOM:MCONtrol:OPower
Sets the zoom to the maximum transmit off power.

:DISPlay:TD_SCDMA:DDEMod:MView:ZOOM:TSLot[:START] (No Query Form)

Sets the zoom to the timeslot start in the main view during the digital modulation related measurement. This command is valid only when :DISPlay:TD_SCDMA:DDEMod:MView:FORMat is set to TPVTime.

Syntax :DISPlay:TD_SCDMA:DDEMod:MView:ZOOM:TSLot[:START]

Arguments None

Measurement Modes DEMTD_SCDMA

Examples :DISPlay:TD_SCDMA:DDEMod:MView:ZOOM:TSLot:START
Sets the zoom to the timeslot start.

:DISPlay:TD_SCDMA:DDEMod:SVIew:FORMat(?)

Selects or queries the display format of the subview in the digital modulation related measurement.

Syntax :DISPlay:TD_SCDMA:DDEMod:SVIew:FORMat { SPECTrum | MACCuracy | SCONste | EVM | MERRor | PERRor | CDPower | CVSFrame | CVSYmbol | PCGRam | TPVTime | LPVTime | SPVTime | STable }

:DISPlay:TD_SCDMA:DDEMod:SVIew:FORMat?

Arguments The arguments and display formats are listed below:

Argument	Display format
SPECTrum	Spectrum
MACCuracy	Modulation accuracy
SCONste	Symbol constellation
EVM	Error vector magnitude (EVM)
MERRor	Amplitude (magnitude) error
PERRor	Phase error
CDPower	Code domain power
CVSFrame	Code domain power versus subframe
CVSYmbol	Code domain power versus symbol
PCGRam	Power codogram
TPVTime	Timeslot power versus time
LPVTime	Power versus time with limit mask
SPVTime	Subframe power versus time
STABLE	Symbol table

Measurement Modes DEMTD_SCDMA

Examples :DISPlay:TD_SCDMA:DDEMod:SVIew:FORMat SPECTrum
displays the spectrum in the subview under the TD-SCDMA standard.

Related Commands :DISPlay:TD_SCDMA:DDEMod:MVIew:FORMat

:DISPlay:TD_SCDMA:DDEMod:SVIew:RADix(?)

Sets or queries the base of symbols on the subview during the TD-SCDMA analysis.

NOTE. This command is valid only when :DISPlay:TD_SCDMA:SVIew:FORMat is set to STABLE.

Syntax :DISPlay:TD_SCDMA:DDEMod:SVIew:RADix { BINary | OCTal
| HEXadecimal }

:DISPlay:TD_SCDMA:DDEMod:SVIew:RADix?

Arguments The arguments and base display are listed below:

Argument	Base
BINary	Binary notation
OCTal	Octal notation
HEXadecimal	Hexadecimal notation

Measurement Modes DEMTD_SCDMA

Examples :DISPlay:TD_SCDMA:DDEMod:SVIew:RADix BINary
sets the subview display to show the symbols in binary under the TD-SCDMA standard.

:DISPlay:TD_SCDMA:DDEMod:SVIew:X[:SCALE]:OFFSet(?)

Sets or queries the minimum horizontal value (left edge) in the subview during the digital modulation related measurement.

NOTE. This command is not available when :DISPlay:TD_SCDMA:DDEMod:SVIew:FORMat is set to MACCuracy.

Syntax :DISPlay:TD_SCDMA:DDEMod:SVIew:X[:SCALE]:OFFSet <numeric_value>
 :DISPlay:TD_SCDMA:DDEMod:SVIew:X[:SCALE]:OFFSet?

Arguments <numeric_value>::=<NRf> specifies the minimum horizontal value in the subview. Refer to *Note on Horizontal Scaling* on page 2-184 for setting the scale.

Measurement Modes DEMTD_SCDMA

Examples :DISPlay:TD_SCDMA:DDEMod:SVIew:X:SCALE:OFFSet 10
 sets the minimum horizontal value to 10 chips when the subview displays EVM under the TD-SCDMA standard.

Related Commands :DISPlay:TD_SCDMA:DDEMod:SVIew:FORMat

:DISPlay:TD_SCDMA:DDEMod:SVIew:X[:SCALE]:PDIVision(?)

Sets or queries the horizontal, or time, scale (per division) in the subview. This command is valid when :DISPlay:TD_SCDMA:DDEMod:SVIew:FORMat is set to TPVTime, LPVTime, or SPVTime.

Syntax :DISPlay:TD_SCDMA:DDEMod:SVIew:X[:SCALE]:PDIVision
<numeric_value>
:DISPlay:TD_SCDMA:DDEMod:SVIew:X[:SCALE]:PDIVision?

Arguments <numeric_value>::=<NRF> specifies the horizontal scale in the subview. Refer to *Note on Horizontal Scaling* on page 2-184 for setting the scale.

Measurement Modes DEMTD_SCDMA

Examples :DISPlay:TD_SCDMA:DDEMod:SVIew:X[:SCALE]:PDIVision 1us
sets the horizontal scale to 1 ms/div in the subview under the TD-SCDMA standard.

:DISPlay:TD_SCDMA:DDEMod:SVIew:X[:SCALe]:RANGe(?)

Sets or queries the full-scale value of the horizontal axis in the subview during the digital modulation related measurement.

NOTE. This command is not available when :DISPlay:TD_SCDMA:DDEMod:SVIew:FORMat is set to MACCuracy.

Syntax :DISPlay:TD_SCDMA:DDEMod:SVIew:X[:SCALe]:RANGe <numeric_value>
 :DISPlay:TD_SCDMA:DDEMod:SVIew:X[:SCALe]:RANGe?

Arguments <numeric_value>::=<NRf> specifies the full-scale value of the horizontal axis in the subview. Refer to *Note on Horizontal Scaling* on page 2-184 for setting the scale.

Measurement Modes DEMTD_SCDMA

Examples :DISPlay:TD_SCDMA:DDEMod:SVIew:X:SCALe:RANGe 512
 sets the full-scale value of the horizontal axis to 512 chips when the subview displays EVM under the TD-SCDMA standard.

Related Commands :DISPlay:TD_SCDMA:DDEMod:SVIew:FORMat

:DISPlay:TD_SCDMA:DDEMod:SVIew:Y[:SCALE]:FIT (No Query Form)

Runs auto-scale on the subview during the digital modulation related measurement. The auto-scale automatically sets the start value and scale of the vertical axis so that the whole waveform is displayed on the screen.

Syntax :DISPlay:TD_SCDMA:DDEMod:SVIew:Y[:SCALE]:FIT

Arguments None

Measurement Modes DEMTD_SCDMA

Examples :DISPlay:TD_SCDMA:DDEMod:SVIew:Y:SCALE:FIT
runs auto-scale on the subview under the TD-SCDMA standard.

Related Commands :DISPlay:TD_SCDMA:DDEMod:SVIew:FORMat

:DISPlay:TD_SCDMA:DDEMod:SVIew:Y[:SCALE]:FULL (No Query Form)

Sets the vertical axis in the subview to the default full-scale value during the digital modulation related measurement.

Syntax :DISPlay:TD_SCDMA:DDEMod:SVIew:Y[:SCALE]:FULL

Arguments None

Measurement Modes DEMTD_SCDMA

Examples :DISPlay:TD_SCDMA:DDEMod:SVIew:Y:SCALE:FULL
sets the subview's vertical axis to the default full-scale value under the TD-SCDMA standard.

Related Commands :DISPlay:TD_SCDMA:DDEMod:SVIew:FORMat

:DISPlay:TD_SCDMA:DDEMod:SVIew:Y[:SCALe]:OFFSet(?)

Sets or queries the minimum vertical value (bottom) in the subview during the digital modulation related measurement.

NOTE. *NOTE.* This command is not available when :DISPlay:TD_SCDMA:DDEMod:SVIew:FORMat is set to MACCuracy.

Syntax :DISPlay:TD_SCDMA:DDEMod:SVIew:Y[:SCALe]:OFFSet<numeric_value>
 :DISPlay:TD_SCDMA:DDEMod:SVIew:Y[:SCALe]:OFFSet?

Arguments <numeric_value>::=<NRf> specifies the minimum vertical value in the subview. The valid range depends on the display format. Refer to Table D-8 in Appendix D.

Measurement Modes DEMTD_SCDMA

Examples :DISPlay:TD_SCDMA:DDEMod:SVIew:Y:SCALe:OFFSet -100dB
 sets the minimum vertical value to -100 dBm when the subview displays spectrum under the TD-SCDMA standard.

Related Commands :DISPlay:TD_SCDMA:DDEMod:SVIew:FORMat

:DISPlay:TD_SCDMA:DDEMod:SVIew:Y[:SCALe]:PDIVision(?)

Sets or queries the vertical, or power, scale (per division) in the subview. This command is valid when :DISPlay:TD_SCDMA:DDEMod:SVIew:FORMat is set to TPVTime, LPVTime, or SPVTime.

Syntax :DISPlay:TD_SCDMA:DDEMod:SVIew:Y[:SCALe]:PDIVision
<numeric_value>
:DISPlay:TD_SCDMA:DDEMod:SVIew:Y[:SCALe]:PDIVision?

Arguments <numeric_value>::=<NRF> specifies the vertical scale in the subview.

Measurement Modes DEMTD_SCDMA

Examples :DISPlay:TD_SCDMA:DDEMod:SVIew:Y:SCALe:PDIVision 1dBm
sets the vertical scale to 1 dBm/div in the subview under the TD-SCDMA standard.

:DISPlay:TD_SCDMA:DDEMod:SVIew:Y[:SCALe]:PUNit(?)

Selects or queries the unit on the Y, or power, axis in the subview during the digital modulation related measurement.

This command is valid when :DISPlay:TD_SCDMA:DDEMod:SVIew:FORMat is set to CDPower, CVSYmbol, PCGRam, or CVSFrame.

Syntax :DISPlay:TD_SCDMA:DDEMod:SVIew:Y[:SCALe]:PUNit{RELative|ABSolute}
 :DISPlay:TD_SCDMA:DDEMod:SVIew:Y[:SCALe]:PUNit?

Arguments RELative represents the relative channel power to the total power of all the channels along the Y axis in dB.

 ABSolute represents the absolute power of each channel along the Y axis in dBm.

Measurement Modes DEMTD_SCDMA

Examples :DISPlay:TD_SCDMA:DDEMod:SVIew:Y:SCALe:PUNit ABSolute
 sets the Y axis unit in the subview to Absolute under the TD-SCDMA standard.

Related Commands :DISPlay:TD_SCDMA:DDEMod:SVIew:FORMat

:DISPlay:TD_SCDMA:DDEMod:SVIew:Y[:SCALE]:RANGe(?)

Sets or queries the full-scale value of the vertical axis in the subview during the digital modulation related measurement.

Syntax :DISPlay:TD_SCDMA:DDEMod:SVIew:Y[:SCALE]:RANGe <numeric_value>
 :DISPlay:TD_SCDMA:DDEMod:SVIew:Y[:SCALE]:RANGe?

Arguments <numeric_value>::=<NRf> specifies the full-scale value of the vertical axis in the subview. The valid range depends on the display format. Refer to Table D-8 in *Appendix D*.

Measurement Modes DEMTD_SCDMA

Examples :DISPlay:TD_SCDMA:DDEMod:SVIew:Y:SCALE:RANGe 100dB
 sets the full-scale value of the vertical axis to 100 dB when the subview displays spectrum under the TD-SCDMA standard.

Related Commands :DISPlay:TD_SCDMA:DDEMod:SVIew:FORMat

:DISPlay:TD_SCDMA:DDEMod:SVIew:ZOOM:MCONtrol[:START] (No Query Form)

Sets the zoom to the transmit mask start in the subview during the digital modulation related measurement. This command is valid only when :DISPlay:TD_SCDMA:DDEMod:SVIew:FORMat is set to LPVTime.

Syntax :DISPlay:TD_SCDMA:DDEMod:SVIew:ZOOM:MCONtrol[:START]

Arguments None

Measurement Modes DEMTD_SCDMA

Examples :DISPlay:TD_SCDMA:DDEMod:SVIew:ZOOM:MCONtrol[:START]
Sets the zoom to the transmit mask start.

:DISPlay:TD_SCDMA:DDEMod:SVIew:ZOOM:MCONtrol:END (No Query Form)

Sets the zoom to the transmit mask end in the subview during the digital modulation related measurement. This command is valid only when :DISPlay:TD_SCDMA:DDEMod:SVIew:FORMat is set to LPVTime.

Syntax :DISPlay:TD_SCDMA:DDEMod:SVIew:ZOOM:MCONtrol:END

Arguments None

Measurement Modes DEMTD_SCDMA

Examples :DISPlay:TD_SCDMA:DDEMod:SVIew:ZOOM:MCONtrol:END
Sets the zoom to the transmit mask end.

:DISPlay:TD_SCDMA:DDEMod:SVIew:ZOOM:TSLot[:START] (No Query Form)

Sets the zoom to the timeslot start in the subview during the digital modulation related measurement. This command is available only when :DISPlay :TD_SCDMA:DDEMod:SVIew:FORMat is set to TPVTime.

Syntax :DISPlay:TD_SCDMA:DDEMod:SVIew:ZOOM:TSLot[:START]

Arguments None

Measurement Modes DEMTD_SCDMA

Examples :DISPlay:TD_SCDMA:DDEMod:SVIew:ZOOM:TSLot[:START]
Sets the zoom to the timeslot start.

:DISPlay:TD_SCDMA:SPECTrum Subgroup

TD-SCDMA Analysis, Option 28 Only

The :DISPlay:TD_SCDMA:SPECTrum commands control the spectrum display in the channel power, intermodulation, spectrum emission mask (SEM), and occupied bandwidth measurements under the TD-SCDMA standard.

NOTE. To use a command from this group, you must have selected *DEMTD_SCDMA (TD-SCDMA analysis)* in the *:INSTrument[:SElect]* command.

Command Tree	Header	Parameter
	:DISPlay	
	:TD_SCDMA	
	:SPECTrum	
	:X	
	[:SCALE]	
	:OFFSet	<numeric_value>
	:PDIVision	<numeric_value>
	:Y	
	[:SCALE]	
	:FIT	
	:FULL	
	:OFFSet	<numeric_value>
	:PDIVision	<numeric_value>

:DISPlay:TD_SCDMA:SPECTrum:X[:SCALe]:OFFSet(?)

Sets or queries the minimum value (left edge) of the horizontal axis (frequency) in the spectrum view.

Syntax :DISPlay:TD_SCDMA:SPECTrum:X[:SCALe]:OFFSet <numeric_value>
 :DISPlay:TD_SCDMA:SPECTrum:X[:SCALe]:OFFSet?

Arguments <numeric_value>::=<NRF> specifies the minimum horizontal value in the spectrum view. Refer to *Note on Horizontal Scaling* on page 2-184 for setting the scale.

Measurement Modes DEMTD_SCDMA

Example :DISPlay:TD_SCDMA:SPECTrum:X:SCALe:OFFSet 100MHz
 sets the minimum horizontal value to 100 MHz in the spectrum view under the TD-SCDMA standard.

:DISPlay:TD_SCDMA:SPECTrum:X[:SCALe]:PDIVision(?)

Sets or queries the horizontal, or frequency, scale (per division) in the spectrum view.

Syntax :DISPlay:TD_SCDMA:SPECTrum:X[:SCALe]:PDIVision <numeric_value>
 :DISPlay:TD_SCDMA:SPECTrum:X[:SCALe]:PDIVision?

Arguments <numeric_value>::=<NRF> specifies the horizontal scale in the spectrum view. Refer to *Note on Horizontal Scaling* on page 2-184 for setting the scale.

Measurement Modes DEMTD_SCDMA

Example :DISPlay:TD_SCDMA:SPECTrum:X:SCALe:PDIVision 100kHz
 sets the horizontal scale to 100 kHz/div in the spectrum view under the TD-SCDMA standard.

:DISPlay:TD_SCDMA:SPECTrum:Y[:SCALE]:FIT (No Query Form)

Runs autoscale on the spectrum view. The auto-scale automatically sets the value and scale of the vertical axis so that the whole waveform is displayed on the screen.

Syntax :DISPlay:TD_SCDMA:SPECTrum:Y[:SCALE]:FIT

Arguments None

Measurement Modes DEMTD_SCDMA

Example :DISPlay:TD_SCDMA:SPECTrum:Y:SCALE:FIT
runs auto-scale on the spectrum view under the TD-SCDMA standard.

:DISPlay:TD_SCDMA:SPECTrum:Y[:SCALE]:FULL (No Query Form)

Sets the vertical axis to the default full-scale value in the spectrum view.

Syntax :DISPlay:TD_SCDMA:SPECTrum:Y[:SCALE]:FULL

Arguments None

Measurement Modes DEMTD_SCDMA

Example :DISPlay:TD_SCDMA:SPECTrum:Y:SCALE:FULL
sets the vertical axis to the default full-scale value in the spectrum view under the TD-SCDMA standard.

:DISPlay:TD_SCDMA:SPECTrum:Y[:SCALe]:OFFSet(?)

Sets or queries the minimum vertical, or amplitude value (bottom) in the spectrum view.

Syntax :DISPlay:TD_SCDMA:SPECTrum:Y[:SCALe]:OFFSet <numeric_value>
:DISPlay:TD_SCDMA:SPECTrum:Y[:SCALe]:OFFSet?

Arguments <numeric_value>::=<NRf> specifies the minimum vertical value.
Range: -200 to 100 dBm

Measurement Modes DEMTD_SCDMA

Example :DISPlay:TD_SCDMA:SPECTrum:Y:SCALe:OFFSet -100dBm
sets the minimum vertical value to -100 dBm in the spectrum view under the TD-SCDMA standard.

:DISPlay:TD_SCDMA:SPECTrum:Y[:SCALe]:PDIVision(?)

Sets or queries the vertical, or power, scale (per division) in the spectrum view.

Syntax :DISPlay:TD_SCDMA:SPECTrum:Y[:SCALe]:PDIVision <numeric_value>
:DISPlay:TD_SCDMA:SPECTrum:Y[:SCALe]:PDIVision?

Arguments <numeric_value>::=<NRf> specifies the vertical scale in the spectrum view.
Range: 0 to 10 dB/div

Measurement Modes DEMTD_SCDMA

Example :DISPlay:TD_SCDMA:SPECTrum:Y:SCALe:PDIVision 10dB
sets the vertical scale to 10 dB/div in the spectrum view under the TD-SCDMA standard.

:DISPlay:M2WLAN:DDEMod Subgroup**WLAN, Option 29 Only**

The :DISPlay:M2WLAN:DDEMod commands control display of the main view and subview for the IEEE802.11n MIMO (2x2) analysis.

NOTE. To use a command from this group, you must have selected DEMM2WLAN (IEEE802.11n MIMO (2x2) analysis) in the :INSTrument[:SElect] command.

Use the [:SENSe]:M2WLAN:MEASurement command to select the measurement item in the MIMO (2x2) analysis.

Command Tree	Header	Parameter
	:DISPlay	
	:M2WLAN	
	:DDEMod	
	:MVieW	
	:MCONteNt	EVM MERRor PERRor
	:RADix	BINary OCTal HEXadecima1
	:RXANteNna	
	[:SElect]	ONE TWO
	:TYPE	GRAPh LIST
	:X	
	[:SCALE]	
	:OFFSet	<numeric_value>
	:PDIVision	<time>
	:RANGe	<numeric_value>
	:Y	
	[:SCALE]	
	:FIT	
	:FULL	
	:OFFSet	<numeric_value>
	:PDIVision	<amplitude>
	:PWUNit	DBM W
	:RANGe	<numeric_value>
	:UNIT	HZ PPM
	:SVieW	
	:FORMat	SPECTrum RX2Waveform ATGRam ATFuction PTGRam PTFunction DGRam DPRofile CONSTe VECTor EVTime PVTime SCConste SCVector EVSC PVSC FERRor STABle
	:MCONteNt	EVM MERRor PERRor
	:RADix	BINary OCTal HEXadecima1

```
:RXAntenna
  [:SElect]      ONE | TWO
:X
  [:SCALE]
    :OFFSet      <numeric_value>
    :PDIVision   <time>
    :RANGe       <numeric_value>
:Y
  [:SCALE]
    :FIT
    :FULL
    :OFFSet      <numeric_value>
    :PDIVision   <amplitude>
    :PWUNit      DBM | W
    :RANGe       <numeric_value>
    :UNIT        HZ | PPM
```

:DISPlay:M2WLAN:DDEMod:MView:MCONTENT(?)

Selects or queries the measurement content of the main view in the 802.11n MIMO (2x2) analysis. This command is valid when [:SENSe]:M2WLAN:MEASurement is set to EVTime or EVSC.

Syntax :DISPlay:M2WLAN:DDEMod:MView:MCONTENT { EVM | MERRor | PERRor }
 :DISPlay:M2WLAN:DDEMod:MView:MCONTENT?

Arguments EVM selects the EVM.
 MERRor selects the magnitude (amplitude) error.
 PERRor selects the phase error.

Measurement Modes DEMM2WLAN

Examples :DISPlay:M2WLAN:DDEMod:MView:MCONTENT EVM
 selects the EVM for the main view content.

Related Commands [:SENSe]:M2WLAN:MEASurement

:DISPlay:M2WLAN:DDEMod:MView:RADix(?)

Selects or queries the base of symbols in the main view during the 802.11n MIMO (2x2) analysis. This command is valid when [:SENSe]:M2WLAN:MEASurement is set to STABLE (symbol table).

Syntax :DISPlay:M2WLAN:DDEMod:MView:RADix
 { BINary | OCTal | HEXadecimal }
 :DISPlay:M2WLAN:DDEMod:MView:RADix?

Arguments BINary selects binary notation.
 OCTal selects octal notation.
 HEXadecimal selects hexadecimal notation.

Measurement Modes DEMM2WLAN

Examples :DISPlay:M2WLAN:DDEMod:MView:RADix BINary
 selects binary notation for the symbol table.

Related Commands :DISPlay:M2WLAN:DDEMod:SVIew:FORMat

:DISPlay:M2WLAN:DDEMod:MView:RXAntenna[:SElect](?)

Selects or queries the receiving antenna to display data in the main view during the 802.11n MIMO (2x2) analysis.

Syntax :DISPlay:M2WLAN:DDEMod:MView:RXAntenna[:SElect] { ONE | TWO }
 :DISPlay:M2WLAN:DDEMod:MView:RXAntenna[:SElect]?

Arguments ONE displays the measurement results for signals received by Rx Antenna 1.
 TWO displays the measurement results for signals received by Rx Antenna 2.

Measurement Modes DEMM2WLAN

Examples :DISPlay:M2WLAN:DDEMod:MView:RXAntenna:SElect ONE
 displays the results for signals received by Rx Antenna 1 in the main view.

:DISPlay:M2WLAN:DDEMod:MView:TYPE(?)

Selects or queries the display type in the main view during the 802.11n MIMO (2x2) analysis. This command is valid when [:SENSe]:M2WLAN:MEASurement is set to EVTime, PVTime, CONSte, EVSC, PVSC, SCConste, FERRor, or STABLE.

Syntax :DISPlay:M2WLAN:DDEMod:MView:TYPE { GRAPH | LIST }
 :DISPlay:M2WLAN:DDEMod:MView:TYPE?

Arguments GRAPH displays the measurement results in a graph.
 LIST displays the measurement results in a list.

Measurement Modes DEMM2WLAN

Examples :DISPlay:M2WLAN:DDEMod:MView:RADix GRAPH
 selects the graph display.

Related Commands [:SENSe]:M2WLAN:MEASurement

:DISPlay:M2WLAN:DDEMod:MView:X[:SCALE]:OFFSet(?)

Sets or queries the minimum horizontal value (left edge) in the main view during the 802.11n MIMO (2x2) analysis.

Syntax :DISPlay:M2WLAN:DDEMod:MView:X[:SCALE]:OFFSet <value>

:DISPlay:M2WLAN:DDEMod:MView:X[:SCALE]:OFFSet?

Arguments <value>::=<Nrf> specifies the minimum horizontal value in the main view. Refer to *Note on Horizontal Scaling* on page 2-184 for setting the scale.

Measurement Modes DEMM2WLAN

Examples :DISPlay:M2WLAN:DDEMod:MView:X:SCALE:OFFSet -40us
sets the minimum horizontal value to -40 μ s when the main view displays the frequency error.

Related Commands [:SENSe]:M2WLAN:MEASurement

:DISPlay:M2WLAN:DDEMod:MView:X[:SCALE]:PDIVision(?)

Sets or queries the horizontal scale (time per division) for the time domain display in the main view. This command is valid when [:SENSe]:M2WLAN:MEASurement is set to EVTime, PVTime, EVSC, PVSC, or FERRor (EVSC and PVSC are for non-OFDM display data).

Syntax :DISPlay:M2WLAN:DDEMod:MView:X[:SCALE]:PDIVision <time>

:DISPlay:M2WLAN:DDEMod:MView:X[:SCALE]:PDIVision?

Arguments <time>::=<Nrf> specifies the horizontal scale. Refer to *Note on Horizontal Scaling* on page 2-184 for setting the scale.

Measurement Modes DEMM2WLAN

Examples :DISPlay:M2WLAN:DDEMod:MView:X:SCALE:PDIVision 10us
sets the horizontal scale to 10 μ s/div in the the frequency error view.

Related Commands [:SENSe]:M2WLAN:MEASurement

:DISPlay:M2WLAN:DDEMod:MView:X[:SCALe]:RANGe(?)

Sets or queries the full-scale value of the horizontal axis in the main view during the 802.11n MIMO (2x2) analysis.

Syntax :DISPlay:M2WLAN:DDEMod:MView:X[:SCALe]:RANGe <value>

 :DISPlay:M2WLAN:DDEMod:MView:X[:SCALe]:RANGe?

Arguments <value>::=<NRf> specifies a full-scale value of the horizontal axis.
Refer to *Note on Horizontal Scaling* on page 2-184 for setting the scale.

Measurement Modes DEMM2WLAN

Examples :DISPlay:M2WLAN:DDEMod:MView:X:SCALe:RANGe 40us
sets the full-scale value of the horizontal axis to 40 μ s when the main view displays the frequency error.

Related Commands [:SENSe]:M2WLAN:MEASurement

:DISPlay:M2WLAN:DDEMod:MView:Y[:SCALE]:FIT (No Query Form)

Runs auto-scale on the main view during the 802.11n MIMO (2x2) analysis. The auto-scale automatically sets the start value and scale of the vertical axis to fit the waveform to the screen.

Syntax :DISPlay:M2WLAN:DDEMod:MView:Y[:SCALE]:FIT

Arguments None

Measurement Modes DEMM2WLAN

Examples :DISPlay:M2WLAN:DDEMod:MView:Y:SCALE:FIT
runs the auto-scale on the main view.

Related Commands [:SENSe]:M2WLAN:MEASurement

:DISPlay:M2WLAN:DDEMod:MView:Y[:SCALE]:FULL (No Query Form)

Sets the vertical axis in the main view to the default full-scale value during the 802.11n MIMO (2x2) analysis.

Syntax :DISPlay:M2WLAN:DDEMod:MView:Y[:SCALE]:FULL

Arguments None

Measurement Modes DEMM2WLAN

Examples :DISPlay:M2WLAN:DDEMod:MView:Y:SCALE:FULL
sets the main view's vertical axis to the default full-scale value.

Related Commands [:SENSe]:M2WLAN:MEASurement

:DISPlay:M2WLAN:DDEMod:MView:Y[:SCALE]:OFFSet(?)

Sets or queries the minimum vertical value (bottom) in the main view during the 802.11n MIMO (2x2) analysis.

Syntax :DISPlay:M2WLAN:DDEMod:MView:Y[:SCALE]:OFFSet <value>
 :DISPlay:M2WLAN:DDEMod:MView:Y[:SCALE]:OFFSet?

Arguments <value>::=<NRf> specifies the minimum vertical value in the main view. The valid range depends on the display format. Refer to Table D-9 in *Appendix D*.

Measurement Modes DEMM2WLAN

Examples :DISPlay:M2WLAN:DDEMod:MView:Y:SCALE:OFFSet -15pct
 sets the minimum vertical value to -15% when the main view displays the EVM versus Time.

Related Commands [:SENSe]:M2WLAN:MEASurement

:DISPlay:M2WLAN:DDEMod:MView:Y[:SCALE]:PDIVision(?)

Sets or queries the vertical scale (per division) in the time domain display in the main view. This command is valid when [:SENSe]:M2WLAN:MEASurement is set to EVTime, PVTime, EVSC, PVSC, or FERRor (EVSC and PVSC are for non-OFDM display data).

Syntax :DISPlay:M2WLAN:DDEMod:MView:Y[:SCALE]:PDIVision <value>
 :DISPlay:M2WLAN:DDEMod:MView:Y[:SCALE]:PDIVision?

Arguments <value>::=<NRf> specifies the vertical scale in the main view. The valid range depends on the display format. Refer to Table D-9 in *Appendix D*.

Measurement Modes DEMM2WLAN

Examples :DISPlay:M2WLAN:DDEMod:MView:Y:SCALE:PDIVision 10pct
 sets the vertical scale to 10%/div in the EVM versus Time view.

Related Commands [:SENSe]:M2WLAN:MEASurement

:DISPlay:M2WLAN:DDEMod:MView:Y[:SCALE]:PWUnit(?)

Selects or queries the unit of power for the delay profile measurement in the main view during the 802.11n MIMO (2x2) analysis. This command is valid when [:SENSe]:M2WLAN:MEASurement is set to DPRofile (delay profile).

Syntax :DISPlay:M2WLAN:DDEMod:MView:Y[:SCALE]:PWUnit { DBM | W }
 :DISPlay:M2WLAN:DDEMod:MView:Y[:SCALE]:PWUnit?

Arguments DBM selects dBm for the unit of power.
 W selects watt for the unit of power.

Measurement Modes DEMM2WLAN

Examples :DISPlay:M2WLAN:DDEMod:MView:Y:SCALE:PWUnit DBM
 selects dBm for the unit of power for the delay profile.

Related Commands [:SENSe]:M2WLAN:MEASurement

:DISPlay:M2WLAN:DDEMod:MView:Y[:SCALe]:RANGe(?)

Sets or queries full-scale value of the vertical axis in the main view during the 802.11n MIMO (2x2) analysis.

Syntax :DISPlay:M2WLAN:DDEMod:MView:Y[:SCALe]:RANGe <value>

:DISPlay:M2WLAN:DDEMod:MView:Y[:SCALe]:RANGe?

Arguments <value>: :=<NRf> specifies a full-scale value of the vertical axis.
The valid setting range depends on the display format. Refer to Table D-9 in *Appendix D*.

Measurement Modes DEMM2WLAN

Examples :DISPlay:M2WLAN:DDEMod:MView:Y:SCALe:RANGe 10
sets full-scale value of the vertical axis to 10% when the the main view displays the EVM versus Time.

Related Commands [:SENSe]:M2WLAN:MEASurement

:DISPlay:M2WLAN:DDEMod:MView:Y[:SCALE]:UNIT(?)

Selects or queries the unit of the vertical axis for the frequency error measurement in the 802.11n MIMO (2x2) analysis. This command is valid when [:SENSe]:M2WLAN:MEASurement is set to FERRor (frequency error).

Syntax :DISPlay:M2WLAN:DDEMod:MView:Y[:SCALE]:UNIT { HZ | PPM }
 :DISPlay:M2WLAN:DDEMod:MView:Y[:SCALE]:UNIT?

Arguments HZ selects Hz for the unit of the vertical axis.
 PPM selects ppm for the unit of the vertical axis.

Measurement Modes DEMM2WLAN

Examples :DISPlay:M2WLAN:DDEMod:MView:Y:SCALE:UNIT HZ
 selects Hz for the unit of the vertical axis in the frequency error measurement.

Related Commands [:SENSe]:M2WLAN:MEASurement

:DISPlay:M2WLAN:DDEMod:SVIew:FORMat(?)

Selects or queries the display format of the subview in the 802.11n MIMO (2x2) analysis.

Syntax :DISPlay:M2WLAN:DDEMod:SVIew:FORMat { SPECTrum | RX2Waveform | ATGRam | ATFuction | PTGRam | PTFunction | DGRam | DPRofile | CONSte | VECTor | EVTime | PVTime | SCConste | SCVector | EVSC | PVSC | FERRor | STABle }

:DISPlay:M2WLAN:DDEMod:SVIew:FORMat?

Arguments The arguments and display formats are listed below:

Table 2-57: Subview display formats, MIMO

Argument	Display format
SPECTrum	Spectrum
RX2WAVEform	Rx anntena #1 and #2 waveforms
ATGRam	Amplitude transfogram
ATFunction	Amplitude transfer function
PTGRam	Phase transfogram
PTFunction	Phase transfer function
DGRam	Delayogram
DPRofile	Delay pofile
CONSte	Constellation
VECTor	Vector
EVTime	EVM versus Time
PVTime	Power versus Time
SCConste	Subcarrier constellation
SCVector	Subcarrier vector
EVSC	EVM versus Subcarrier
PVSC	Power versus Subcarrier
FERRor	Frequency error
STABle	Symbol table

Measurement Modes DEMM2WLAN

Examples :DISPlay:M2WLAN:DDEMod:SVIew:FORMat CONSte
displays the constellation in the subview.

Related Commands [:SENSe]:M2WLAN:MEASurement

:DISPlay:M2WLAN:DDEMod:SVIew:MCONtent(?)

Selects or queries the measurement content of the subview in the 802.11n MIMO (2x2) analysis. This command is valid when :DISPlay:M2WLAN:DDEMod:SVIew:FORMat is set to EVTime or EVSC.

Syntax :DISPlay:M2WLAN:DDEMod:SVIew:MCONtent { EVM | MERRor | PERRor }
:DISPlay:M2WLAN:DDEMod:SVIew:MCONtent?

Arguments EVM selects the EVM.
MERRor selects the magnitude (amplitude) error.
PERRor selects the phase error.

Measurement Modes DEMM2WLAN

Examples :DISPlay:M2WLAN:DDEMod:SVIew:MCONtent EVM
selects the EVM for the subview content.

Related Commands :DISPlay:M2WLAN:DDEMod:SVIew:FORMat

:DISPlay:M2WLAN:DDEMod:SVIew:RADix(?)

Selects or queries the base of symbols in the subview during the 802.11n MIMO (2x2) analysis. This command is valid when :DISPlay:M2WLAN:DDEMod:SVIew:FORMat is set to STABLE (symbol table).

Syntax :DISPlay:M2WLAN:DDEMod:SVIew:RADix
 { BINary | OCTal | HEXadecimal }

 :DISPlay:M2WLAN:DDEMod:SVIew:RADix?

Arguments BINary selects binary notation.

 OCTal selects octal notation.

 HEXadecimal selects hexadecimal notation.

Measurement Modes DEMM2WLAN

Examples :DISPlay:M2WLAN:DDEMod:SVIew:RADix BINary
 selects binary notation for the symbol table.

Related Commands :DISPlay:M2WLAN:DDEMod:SVIew:FORMat

:DISPlay:M2WLAN:DDEMod:SVIew:RXAntenna[:SElect](?)

Selects or queries the receiving antenna to display data in the subview during the 802.11n MIMO (2x2) analysis.

Syntax :DISPlay:M2WLAN:DDEMod:SVIew:RXAntenna[:SElect] { ONE | TWO }

 :DISPlay:M2WLAN:DDEMod:SVIew:RXAntenna[:SElect]?

Arguments ONE displays the measurement results for signals received by Rx Antenna 1.

 TWO displays the measurement results for signals received by Rx Antenna 2.

Measurement Modes DEMM2WLAN

Examples :DISPlay:M2WLAN:DDEMod:SVIew:RXAntenna:SElect ONE
 displays the results for signals received by Rx Antenna 1 in the subview.

:DISPlay:M2WLAN:DDEMod:SVIew:X[:SCALe]:OFFSet(?)

Sets or queries the minimum horizontal value (left edge) in the subview during the 802.11n MIMO (2x2) analysis.

Syntax :DISPlay:M2WLAN:DDEMod:SVIew:X[:SCALe]:OFFSet <value>
:DISPlay:M2WLAN:DDEMod:SVIew:X[:SCALe]:OFFSet?

Arguments <value>::=<Nrf> specifies the minimum horizontal value in the subview. Refer to *Note on Horizontal Scaling* on page 2-184 for setting the scale.

Measurement Modes DEMM2WLAN

Examples :DISPlay:M2WLAN:DDEMod:SVIew:X:SCALe:OFFSet -40us
sets the minimum horizontal value to -40 μ s when the subview displays the frequency error.

Related Commands :DISPlay:M2WLAN:DDEMod:SVIew:FORMat

:DISPlay:M2WLAN:DDEMod:SVIew:X[:SCALe]:PDIVision(?)

Sets or queries the horizontal scale (time per division) for the time domain display in the subview. This command is valid when :DISPlay:M2WLAN:DDEMod:SVIew:FORMat is set to EVTime, PVTime, EVSC, PVSC, or FERRor (EVSC and PVSC are for non-OFDM display data).

Syntax :DISPlay:M2WLAN:DDEMod:SVIew:X[:SCALe]:PDIVision <time>
:DISPlay:M2WLAN:DDEMod:SVIew:X[:SCALe]:PDIVision?

Arguments <time>::=<Nrf> specifies the horizontal scale in the subview. Refer to *Note on Horizontal Scaling* on page 2-184 for setting the scale.

Measurement Modes DEMM2WLAN

Examples :DISPlay:M2WLAN:DDEMod:SVIew:X:SCALe:PDIVision 10us
sets the horizontal scale to 10 μ s/div in the the frequency error view.

Related Commands :DISPlay:M2WLAN:DDEMod:SVIew:FORMat

:DISPlay:M2WLAN:DDEMod:SVIew:X[:SCALe]:RANGe(?)

Sets or queries full-scale value of the horizontal axis in the subview during the 802.11n MIMO (2x2) analysis.

Syntax :DISPlay:M2WLAN:DDEMod:SVIew:X[:SCALe]:RANGe <value>

 :DISPlay:M2WLAN:DDEMod:SVIew:X[:SCALe]:RANGe?

Arguments <value> ::= <NRf> specifies a full-scale value of the horizontal axis.
Refer to *Note on Horizontal Scaling* on page 2-184 for setting the scale.

Measurement Modes DEMM2WLAN

Examples :DISPlay:M2WLAN:DDEMod:SVIew:X:SCALe:RANGe 40us
sets the full-scale value of the horizontal axis to 40 μ s when the subview displays the frequency error.

Related Commands :DISPlay:M2WLAN:DDEMod:SVIew:FORMat

:DISPlay:M2WLAN:DDEMod:SVIew:Y[:SCALe]:FIT (No Query Form)

Runs auto-scale on the subview during the 802.11n MIMO (2x2) analysis. The auto-scale automatically sets the start value and scale of the vertical axis to fit the waveform to the screen.

Syntax :DISPlay:M2WLAN:DDEMod:SVIew:Y[:SCALe]:FIT

Arguments None

Measurement Modes DEMM2WLAN

Examples :DISPlay:M2WLAN:DDEMod:SVIew:Y:SCALe:FIT
runs the auto-scale on the subview.

Related Commands :DISPlay:M2WLAN:DDEMod:SVIew:FORMat

:DISPlay:M2WLAN:DDEMod:SVIew:Y[:SCALe]:FULL (No Query Form)

Sets the vertical axis in the subview to the default full-scale value during the 802.11n MIMO (2x2) analysis.

Syntax :DISPlay:M2WLAN:DDEMod:SVIew:Y[:SCALe]:FULL

Arguments None

Measurement Modes DEMM2WLAN

Examples :DISPlay:M2WLAN:DDEMod:SVIew:Y:SCALe:FULL
sets the vertical axis in the subview to the default full-scale value.

Related Commands :DISPlay:M2WLAN:DDEMod:SVIew:FORMat

:DISPlay:M2WLAN:DDEMod:SVIew:Y[:SCALe]:OFFSet(?)

Sets or queries the minimum vertical value (bottom) in the subview during the 802.11n MIMO (2x2) analysis.

Syntax :DISPlay:M2WLAN:DDEMod:SVIew:Y[:SCALe]:OFFSet <value>

:DISPlay:M2WLAN:DDEMod:SVIew:Y[:SCALe]:OFFSet?

Arguments <value>: :=<Nrf> specifies the minimum vertical value in the subview. The valid setting range depends on the display format. Refer to Table D-9 in *Appendix D*.

Measurement Modes DEMM2WLAN

Examples :DISPlay:M2WLAN:DDEMod:SVIew:Y:SCALe:OFFSet -15pct
sets the minimum vertical value to -15% when the subview displays the EVM versus Time.

Related Commands :DISPlay:M2WLAN:DDEMod:SVIew:FORMat

:DISPlay:M2WLAN:DDEMod:SVIew:Y[:SCALe]:PDIVision(?)

Sets or queries the vertical scale (per division) for the time domain display in the subview. This command is valid when :DISPlay:M2WLAN:DDEMod:SVIew:FORMat is set to EVTime, PVTime, EVSC, PVSC, or FERRor (EVSC and PVSC are for non-OFDM display data).

Syntax :DISPlay:M2WLAN:DDEMod:SVIew:Y[:SCALe]:PDIVision <value>
:DISPlay:M2WLAN:DDEMod:SVIew:Y[:SCALe]:PDIVision?

Arguments <value>::=<NRf> specifies the vertical scale in the subview. The valid setting range depends on the display format. Refer to Table D-9 in *Appendix D*.

Measurement Modes DEMM2WLAN

Examples :DISPlay:M2WLAN:DDEMod:SVIew:Y:SCALe:PDIVision 5pct
sets the vertical scale to 5%/div in the EVM versus Time.

Related Commands :DISPlay:M2WLAN:DDEMod:SVIew:FORMat

:DISPlay:M2WLAN:DDEMod:SVIew:Y[:SCALe]:PWUNit(?)

Selects or queries the unit of power for the delay profile measurement in the subview during the 802.11n MIMO (2x2) analysis.

This command is valid when :DISPlay:M2WLAN:DDEMod:SVIew:FORMat is set to DPRofile (delay profile).

Syntax :DISPlay:M2WLAN:DDEMod:SVIew:Y[:SCALe]:PWUNit { DBM | W }
:DISPlay:M2WLAN:DDEMod:SVIew:Y[:SCALe]:PWUNit?

Arguments DBM selects dBm for the unit of power.
W selects watt for the unit of power.

Measurement Modes DEMM2WLAN

Examples :DISPlay:M2WLAN:DDEMod:SVIew:Y:SCALe:PWUNit DBM
selects dBm for the unit of power in the delay profile.

Related Commands :DISPlay:M2WLAN:DDEMod:SVIew:FORMat

:DISPlay:M2WLAN:DDEMod:SVIew:Y[:SCALe]:RANGe(?)

Sets or queries full-scale value of the vertical axis in the subview during the 802.11n MIMO (2x2) analysis.

Syntax :DISPlay:M2WLAN:DDEMod:SVIew:Y[:SCALe]:RANGe <value>

:DISPlay:M2WLAN:DDEMod:SVIew:Y[:SCALe]:RANGe?

Arguments <value>: :=<NRf> specifies full-scale value of the vertical axis in the subview. The valid setting range depends on the display format. Refer to Table D-9 in *Appendix D*.

Measurement Modes DEMM2WLAN

Examples :DISPlay:M2WLAN:DDEMod:SVIew:Y:SCALe:RANGe 10pct
sets full-scale value of the vertical axis to 10% when the subview displays the EVM versus Time.

Related Commands :DISPlay:M2WLAN:DDEMod:SVIew:FORMat

:DISPlay:M2WLAN:DDEMod:SVIew:Y[:SCALe]:UNIT(?)

Sets or queries the unit of the vertical axis for the frequency error measurement in the subview during the 802.11n MIMO (2x2) analysis. This command is valid when :DISPlay:M2WLAN:DDEMod:SVIew:FORMat is set to FERRor (frequency error).

Syntax :DISPlay:M2WLAN:DDEMod:SVIew:Y[:SCALe]:UNIT { HZ | PPM }
 :DISPlay:M2WLAN:DDEMod:SVIew:Y[:SCALe]:UNIT?

Arguments HZ selects Hz for the unit of the vertical axis.
 PPM selects ppm for the unit of the vertical axis.

Measurement Modes DEMM2WLAN

Examples :DISPlay:M2WLAN:DDEMod:SVIew:Y:SCALe:UNIT HZ
 selects Hz for the unit of the vertical axis in the frequency error measurement.

Related Commands :DISPlay:M2WLAN:DDEMod:SVIew:FORMat

:DISPlay:M2WLAN:TFRequency Subgroup

WLAN, Option 29 Only

The :DISPlay:M2WLAN:TFRequency commands control the following three-dimensional views in the IEEE802.11n MIMO (2x2) analysis.

- Transfogram (Amplitude and Phase)
- Delayogram

NOTE. *To use a command from this group, you must have selected DEMM2WLAN (IEEE802.11n MIMO (2x2) analysis) in the :INSTrument[:SElect] command.*

Command Tree	Header	Parameter
	:DISPlay	
	:M2WLAN	
	:TFRequency	
	:ATGRam	
	:COLor	
	[:SCALE]	
	:OFFSet	<numeric_value>
	:RANge	<numeric_value>
	:X	
	[:SCALE]	
	:OFFSet	<numeric_value>
	:RANge	<numeric_value>
	:Y	
	[:SCALE]	
	:OFFSet	<numeric_value>
	:PLINe	<numeric_value>
	:DGRam	
	:COLor	
	[:SCALE]	
	:OFFSet	<numeric_value>
	:RANge	<numeric_value>
	:X	
	[:SCALE]	
	:OFFSet	<numeric_value>
	:RANge	<numeric_value>
	:Y	
	[:SCALE]	
	:OFFSet	<numeric_value>
	:PLINe	<numeric_value>
	:PTGRam	
	:COLor	
	[:SCALE]	
	:OFFSet	<numeric_value>
	:RANge	<numeric_value>
	:X	
	[:SCALE]	
	:OFFSet	<numeric_value>
	:RANge	<numeric_value>
	:Y	
	[:SCALE]	
	:OFFSet	<numeric_value>
	:PLINe	<numeric_value>

:DISPlay:M2WLAN:TFRrequency:ATGRam:COLor[:SCALe]:OFFSet(?)

Sets or queries the minimum value (bottom edge) of the color axis (amplitude) in the amplitude transfogram.

Syntax :DISPlay:M2WLAN:TFRrequency:ATGRam:COLor[:SCALe]:OFFSet <value>

:DISPlay:M2WLAN:TFRrequency:ATGRam:COLor[:SCALe]:OFFSet?

Arguments <value>::=<Nrf> specifies the minimum color-axis value.
Range: -200 to 0 dBm.

Measurement Modes DEMM2WLAN

Examples :DISPlay:M2WLAN:TFRrequency:ATGRam:COLor:SCALe:OFFSet -100
sets the minimum color-axis value to -100 dBm.

:DISPlay:M2WLAN:TFRrequency:ATGRam:COLor[:SCALe]:RANGe(?)

Sets or queries the full-scale value of the color axis (amplitude) in the amplitude transfogram.

Syntax :DISPlay:M2WLAN:TFRrequency:ATGRam:COLor[:SCALe]:RANGe <value>

:DISPlay:M2WLAN:TFRrequency:ATGRam:COLor[:SCALe]:RANGe?

Arguments <value>::={ 10 | 20 | 50 | 100 } [dB] specifies the full-scale value of the color axis.

Measurement Modes DEMM2WLAN

Examples :DISPlay:M2WLAN:TFRrequency:ATGRam:COLor:SCALe:RANGe 100
sets the full-scale value of the color axis to 100 dB.

:DISPlay:M2WLAN:TFrequency:ATGRam:X[:SCALE]:OFFSet(?)

Sets or queries the minimum value (left edge) of the horizontal axis (subcarrier number) in the amplitude transfogram.

Syntax :DISPlay:M2WLAN:TFrequency:ATGRam:X[:SCALE]:OFFSet <value>

 :DISPlay:M2WLAN:TFrequency:ATGRam:X[:SCALE]:OFFSet?

Arguments <value>::=<NRf> specifies the minimum horizontal value.
Range: -64 to 8.

Measurement Modes DEMM2WLAN

Examples :DISPlay:M2WLAN:TFrequency:ATGRam:X:SCALE:OFFSet -28
sets the minimum horizontal value to the subcarrier #-28.

:DISPlay:M2WLAN:TFrequency:ATGRam:X[:SCALE]:RANGe(?)

Sets or queries the full-scale value of the horizontal axis (subcarrier number) in the amplitude transfogram.

Syntax :DISPlay:M2WLAN:TFrequency:ATGRam:X[:SCALE]:RANGe <value>

 :DISPlay:M2WLAN:TFrequency:ATGRam:X[:SCALE]:RANGe?

Arguments <value>::=<NRf> specifies the horizontal full-scale.
Range: 16 to 128.

Measurement Modes DEMM2WLAN

Examples :DISPlay:M2WLAN:TFrequency:ATGRam:X:SCALE:RANGe 64
sets the horizontal full-scale to 64 subcarriers.

:DISPlay:M2WLAN:TFrequency:ATGRam:Y[:SCALe]:OFFSet(?)

Sets or queries the minimum value (bottom edge) of the vertical axis (packet number) in the amplitude transfoqram.

Syntax :DISPlay:M2WLAN:TFrequency:ATGRam:Y[:SCALe]:OFFSet <value>
:DISPlay:M2WLAN:TFrequency:ATGRam:Y[:SCALe]:OFFSet?

Arguments <value>::=<NR1> specifies the minimum vertical value.
Range: -[(the number of packets in the analysis range) - 1] to 0.
Zero (0) represents the latest packet.

Measurement Modes DEMM2WLAN

Examples :DISPlay:M2WLAN:TFrequency:ATGRam:Y:SCALe:OFFSet -100
sets the minimum vertical value to Packet # -100.

:DISPlay:M2WLAN:TFrequency:ATGRam:Y[:SCALe]:PLINe(?)

Sets or queries the vertical scale (the number of packets per line) in the amplitude transfoqram. Packets are thinned out from all the acquired framed data at intervals of the number of packets specified in this command, before the amplitude transfoqram is displayed. For example, if you set the argument to 5, the data will be displayed every 5 packets.

Syntax :DISPlay:M2WLAN:TFrequency:ATGRam:Y[:SCALe]:PLINe <value>
:DISPlay:M2WLAN:TFrequency:ATGRam:Y[:SCALe]:PLINe?

Arguments <value>::=<NR1> specifies the vertical scale in the amplitude transfoqram.
Range: 1 to 1024 packets per line.

Measurement Modes DEMM2WLAN

Examples :DISPlay:M2WLAN:TFrequency:ATGRam:Y:SCALe:PLINe 5
displays the data in the amplitude transfoqram every 5 packets.

:DISPlay:M2WLAN:TFrequency:DGRam:COLor[:SCALe]:OFFSet(?)

Sets or queries the minimum value (bottom edge) of the color axis (amplitude) in the delayogram.

Syntax :DISPlay:M2WLAN:TFrequency:DGRam:COLor[:SCALe]:OFFSet <value>

:DISPlay:M2WLAN:TFrequency:DGRam:COLor[:SCALe]:OFFSet?

Arguments <value>::=<NRf> specifies the minimum color-axis value.
Range: -200 to 0 dBm.

Measurement Modes DEMM2WLAN

Examples :DISPlay:M2WLAN:TFrequency:DGRam:COLor:SCALe:OFFSet -100
sets the minimum color-axis value to -100 dBm.

:DISPlay:M2WLAN:TFrequency:DGRam:COLor[:SCALe]:RANGe(?)

Sets or queries the full-scale value of the color axis (amplitude) in the delayogram.

Syntax :DISPlay:M2WLAN:TFrequency:DGRam:COLor[:SCALe]:RANGe <value>

:DISPlay:M2WLAN:TFrequency:DGRam:COLor[:SCALe]:RANGe?

Arguments <value>::={ 10 | 20 | 50 | 100 } [dB] specifies the full-scale value of the color axis.

Measurement Modes DEMM2WLAN

Examples :DISPlay:M2WLAN:TFrequency:DGRam:COLor:SCALe:RANGe 50
sets full-scale value of the color axis to 50 dB.

:DISPlay:M2WLAN:TFRrequency:DGRam:X[:SCALe]:OFFSet(?)

Sets or queries the minimum value (left edge) of the horizontal axis (time) in the delayogram.

Syntax :DISPlay:M2WLAN:TFRrequency:DGRam:X[:SCALe]:OFFSet <time>
:DISPlay:M2WLAN:TFRrequency:DGRam:X[:SCALe]:OFFSet?

Arguments <time>::=<NRf> specifies the minimum horizontal value in the delayogram.
Range: $-S_0/2$ to $[S_0/2 - (\text{horizontal full scale})]$ (sec).
Where S_0 is the initial horizontal full scale.

Measurement Modes DEMM2WLAN

Examples :DISPlay:M2WLAN:TFRrequency:DGRam:X:SCALe:OFFSet -2.5ns
sets the minimum horizontal value to -2.5 ns.

:DISPlay:M2WLAN:TFRrequency:DGRam:X[:SCALe]:RANGe(?)

Sets or queries the full-scale value of the horizontal axis (time) in the delayogram.

Syntax :DISPlay:M2WLAN:TFRrequency:DGRam:X[:SCALe]:RANGe <time>
:DISPlay:M2WLAN:TFRrequency:DGRam:X[:SCALe]:RANGe?

Arguments <time>::=<NRf> specifies the full-scale value of the horizontal axis.
Range: $S_0/16$ to S_0 (sec), where S_0 is the initial horizontal full scale.

Measurement Modes DEMM2WLAN

Examples :DISPlay:M2WLAN:TFRrequency:DGRam:X:SCALe:RANGe 5ns
sets the horizontal full-scale to 5 ns.

:DISPlay:M2WLAN:TFrequency:DGRam:Y[:SCALe]:OFFSet(?)

Sets or queries the minimum value (bottom edge) of the vertical axis (packet number) in the delayogram.

Syntax :DISPlay:M2WLAN:TFrequency:DGRam:Y[:SCALe]:OFFSet <value>

:DISPlay:M2WLAN:TFrequency:DGRam:Y[:SCALe]:OFFSet?

Arguments <value> ::= <NR1> specifies the minimum vertical value.
Range: -[(the number of packets in the analysis range) - 1] to 0.
Zero (0) represents the latest packet.

Measurement Modes DEMM2WLAN

Examples :DISPlay:M2WLAN:TFrequency:DGRam:Y:SCALe:OFFSet -100
sets the minimum vertical value to Packet # -100.

:DISPlay:M2WLAN:TFrequency:DGRam:Y[:SCALe]:PLINe(?)

Sets or queries the vertical scale (the number of packets per line) in the delayogram. Packets are thinned out from all the acquired framed data at intervals of the number of packets specified in this command, before the delayogram is displayed. For example, if you set the argument to 5, the data will be displayed every 5 packets.

Syntax :DISPlay:M2WLAN:TFrequency:DGRam:Y[:SCALe]:PLINe <value>

:DISPlay:M2WLAN:TFrequency:DGRam:Y[:SCALe]:PLINe?

Arguments <value> ::= <NR1> specifies the vertical scale in the delayogram.
Range: 1 to 1024 packets per line.

Measurement Modes DEMM2WLAN

Examples :DISPlay:M2WLAN:TFrequency:DGRam:Y:SCALe:PLINe 5
displays the data in the delayogram every 5 packets.

:DISPlay:M2WLAN:TFRrequency:PTGRam:COLor[:SCALE]:OFFSet(?)

Sets or queries the minimum value (bottom edge) of the color axis (phase) in the phase transfogram.

Syntax :DISPlay:M2WLAN:TFRrequency:PTGRam:COLor[:SCALE]:OFFSet <value>
:DISPlay:M2WLAN:TFRrequency:PTGRam:COLor[:SCALE]:OFFSet?

Arguments <value>::=<NRf> specifies the minimum color-axis value.
Range: -1200 to 400°.

Measurement Modes DEMM2WLAN

Examples :DISPlay:M2WLAN:TFRrequency:PTGRam:COLor:SCALE:OFFSet -100
sets the minimum color-axis value to -100°.

:DISPlay:M2WLAN:TFRrequency:PTGRam:COLor[:SCALE]:RANGe(?)

Sets or queries the full-scale value of the color axis (phase) in the phase transfogram.

Syntax :DISPlay:M2WLAN:TFRrequency:PTGRam:COLor[:SCALE]:RANGe <value>
:DISPlay:M2WLAN:TFRrequency:PTGRam:COLor[:SCALE]:RANGe?

Arguments <value>::=<NRf> specifies full-scale value of the color axis.
Range: 800 μ to 800°.

Measurement Modes DEMM2WLAN

Examples :DISPlay:M2WLAN:TFRrequency:PTGRam:COLor:SCALE:RANGe 100
sets the full-scale value of the color axis to 100°.

:DISPlay:M2WLAN:TFrequency:PTGRam:X[:SCALE]:OFFSet(?)

Sets or queries the minimum value (left edge) of the horizontal axis (subcarrier number) in the phase transfoqram.

Syntax :DISPlay:M2WLAN:TFrequency:PTGRam:X[:SCALE]:OFFSet <value>

 :DISPlay:M2WLAN:TFrequency:PTGRam:X[:SCALE]:OFFSet?

Arguments <value>::=<NRf> specifies the minimum horizontal value.
Range: -64 to 8.

Measurement Modes DEMM2WLAN

Examples :DISPlay:M2WLAN:TFrequency:PTGRam:X:SCALE:OFFSet -28
sets the minimum horizontal value to the subcarrier #-28.

:DISPlay:M2WLAN:TFrequency:PTGRam:X[:SCALE]:RANGe(?)

Sets or queries the full-scale value of the horizontal axis (subcarrier number) in the phase transfoqram.

Syntax :DISPlay:M2WLAN:TFrequency:PTGRam:X[:SCALE]:RANGe <value>

 :DISPlay:M2WLAN:TFrequency:PTGRam:X[:SCALE]:RANGe?

Arguments <value>::=<NRf> specifies the horizontal full-scale.
Range: 16 to 128.

Measurement Modes DEMM2WLAN

Examples :DISPlay:M2WLAN:TFrequency:PTGRam:X:SCALE:RANGe 64
sets the horizontal full-scale to 64 subcarriers.

:DISPlay:M2WLAN:TFRrequency:PTGRam:Y[:SCALe]:OFFSet(?)

Sets or queries the minimum value (bottom edge) of the vertical axis (packet number) in the phase transfogram.

Syntax :DISPlay:M2WLAN:TFRrequency:PTGRam:Y[:SCALe]:OFFSet <value>
:DISPlay:M2WLAN:TFRrequency:PTGRam:Y[:SCALe]:OFFSet?

Arguments <value>::=<NR1> specifies the minimum vertical value.
Range: -[(the number of packets in the analysis range) - 1] to 0.
Zero (0) represents the latest packet.

Measurement Modes DEMM2WLAN

Examples :DISPlay:M2WLAN:TFRrequency:PTGRam:Y:SCALe:OFFSet -100
sets the minimum vertical value to Packet # -100.

:DISPlay:M2WLAN:TFRrequency:PTGRam:Y[:SCALe]:PLINe(?)

Sets or queries the vertical scale (the number of packets per line) in the phase transfogram. Packets are thinned out from all the acquired framed data at intervals of the number of packets specified in this command, before the amplitude transfogram is displayed. For example, if you set the argument to 5, the data will be displayed every 5 packets.

Syntax :DISPlay:M2WLAN:TFRrequency:PTGRam:Y[:SCALe]:PLINe <value>
:DISPlay:M2WLAN:TFRrequency:PTGRam:Y[:SCALe]:PLINe?

Arguments <value>::=<NR1> specifies the vertical scale in the phase transfogram.
Range: 1 to 1024 packets per line.

Measurement Modes DEMM2WLAN

Examples :DISPlay:M2WLAN:TFRrequency:PTGRam:Y:SCALe:PLINe 5
displays the data in the phase transfogram every 5 packets.

:DISPlay:SWLAN:DDEMod Subgroup**WLAN, Option 29 Only**

The :DISPlay:SWLAN:DDEMod commands control display of the main view and subview for the IEEE802.11n (nx1) analysis.

NOTE. To use a command from this group, you must have selected DEMSWLAN (IEEE802.11n (nx1) analysis) in the :INSTRument[:SElect] command.

To control the spectrum display in the Spectrum Mask measurement, use the :DISPlay:SWLAN:SPECTrum commands.

To select the measurement item in the 802.11n (nx1) analysis, use the [:SENSe]:SWLAN:MEASurement command.

Command Tree	Header	Parameter
	:DISPlay	
	:SWLAN	
	:DDEMod	
	:MVIew	
	:FORMat	OLINearity DOLinearity
	:MCONtent	EVM MERRor PERRor
	:RADix	BINary OCTal HEXadecimal
	:TYPE	GRAPh LIST
	:X	
	[:SCALe]	
	:CHANnel	
	:BANDwidth	
	:BWIDth	<numeric_value>
	:CPOSition	LOWer CENTer UPPer
	:OFFSet	<numeric_value>
	:PDIVision	<time>
	:RANGe	<numeric_value>
	:Y	
	[:SCALe]	
	:FIT	
	:FULL	
	:OFFSet	<numeric_value>
	:PDIVision	<amplitude>
	:PWUNit	DBM W
	:RANGe	<numeric_value>
	:UNIT	HZ PPM

```

:SVIew
  :FORMat          SPECTrum | ATGRam | ATFuction
                   | PTGRam | PTFunction | DGRam
                   | DPRofile | CONSTe | VECTor
                   | EVTime | PVTime | SCConste
                   | SCVector | EVSC | PVSC
                   | FERRor | OFLatness
                   | OLINearity | DOLinearity
                   | STABle
  :MCONTent        EVM | MERRor | PERRor
  :RADix           BINary | OCTal | HEXadecimal
  :X
    [:SCALE]
      :CHANnel
        :BANDwidth
          |:BWIDth <numeric_value>
        :CPOSITION LOWER | CENTER | UPPER
        :OFFSet     <numeric_value>
        :PDIVision  <time>
        :RANGE      <numeric_value>
  :Y
    [:SCALE]
      :FIT
      :FULL
      :OFFSet      <numeric_value>
      :PDIVision   <amplitude>
      :PWUNIT      DBM | W
      :RANGE       <numeric_value>
      :UNIT        HZ | PPM

```

:DISPlay:SWLAN:DDEMod:MView:FORMat(?)

Selects or queries the display format of the main view in the OFDM linearity measurement in the 802.11n (nx1) analysis. This command is valid when [:SENSe]:SWLAN:MEASurement is set to OLinearity.

Syntax :DISPlay:SWLAN:DDEMod:MView:FORMat { OLinearity | DOLinearity }
 :DISPlay:SWLAN:DDEMod:MView:FORMat?

Arguments OLinearity selects vector display for the OFDM linearity measurement (default).
 DOLinearity selects dot display for the OFDM linearity measurement.

Measurement Modes DEMSWLAN

Examples :DISPlay:SWLAN:DDEMod:MView:FORMat OLinearity
 selects vector display for the OFDM linearity measurement.

Related Commands [:SENSe]:SWLAN:MEASurement

:DISPlay:SWLAN:DDEMod:MView:MCONTENT(?)

Selects or queries the measurement content of the main view in the 802.11n (nx1) analysis. This command is valid when [:SENSe]:SWLAN:MEASurement is set to EVTime or EVSC.

Syntax :DISPlay:SWLAN:DDEMod:MView:MCONTENT { EVM | MERRor | PERRor }
 :DISPlay:SWLAN:DDEMod:MView:MCONTENT?

Arguments EVM selects the EVM.
 MERRor selects the magnitude (amplitude) error.
 PERRor selects the phase error.

Measurement Modes DEMSWLAN

Examples :DISPlay:SWLAN:DDEMod:MView:MCONTENT EVM
 selects the EVM for the main view content.

Related Commands [:SENSe]:SWLAN:MEASurement

:DISPlay:SWLAN:DDEMod:MView:RADix(?)

Selects or queries the base of symbols in the main view in the 802.11n (nx1) analysis. This command is valid when [:SENSe]:SWLAN:MEASurement is set to STABLE (symbol table).

Syntax :DISPlay:SWLAN:DDEMod:MView:RADix
 { BINary | OCTal | HEXadecimal }

 :DISPlay:SWLAN:DDEMod:MView:RADix?

Arguments BINary selects binary notation.

 OCTal selects octal notation.

 HEXadecimal selects hexadecimal notation.

Measurement Modes DEMSWLAN

Examples :DISPlay:SWLAN:DDEMod:MView:RADix BINary
 selects binary notation for the symbol table.

Related Commands [:SENSe]:SWLAN:MEASurement

:DISPlay:SWLAN:DDEMod:MView:TYPE(?)

Selects or queries the display type in the main view during the 802.11n (nx1) analysis. This command is valid when [:SENSe]:SWLAN:MEASurement is set to EVTime, PVTim, CONSte, EVSC, PVSC, SCConste, FERRor, OFLatness, OLINearity, or STABLE.

Syntax :DISPlay:SWLAN:DDEMod:MView:TYPE { GRAPH | LIST }
 :DISPlay:SWLAN:DDEMod:MView:RADix?

Arguments GRAPH displays the measurement results in a graph.
 LIST displays the measurement results in a list.

Measurement Modes DEMSWLAN

Examples :DISPlay:SWLAN:DDEMod:MView:RADix GRAPH
 selects the graph display.

Related Commands [:SENSe]:SWLAN:MEASurement

:DISPlay:SWLAN:DDEMod:MVIew:X[:SCALE]:CHANnel:BANDwidth|:BWIDth(?)

Sets or queries the channel bandwidth for the OFDM flatness measurement in the main view during the 802.11n (nx1) analysis. This command is valid when [:SENSe]:SWLAN:MEASurement is set to OFLatness.

Syntax :DISPlay:SWLAN:DDEMod:MVIew:X[:SCALE]:CHANnel:BANDwidth
 |:BWIDth <value>

 :DISPlay:SWLAN:DDEMod:MVIew:X[:SCALE]:CHANnel:BANDwidth
 |:BWIDth?

Arguments <value>::=<NRf> specifies the channel bandwidth.
Setting value: 20 MHz or 40 MHz.

Measurement Modes DEMSWLAN

Examples :DISPlay:SWLAN:DDEMod:MVIew:X:SCALE:CHANnel:BANDwidth 40MHz
sets the channel bandwidth to 40 MHz for the OFDM flatness measurement.

Related Commands [:SENSe]:SWLAN:MEASurement

:DISPlay:SWLAN:DDEMod:MView:X[:SCALe]:CPOsition(?)

Selects or queries the carrier position for the 20 MHz channel in the OFDM flatness measurement in the main view. This command is valid when [:SENSE]:SWLAN:MEASurement is set to OFLatness (OFDM flatness).

Syntax :DISPlay:SWLAN:DDEMod:MView:X[:SCALe]:CPOsition
 { LOWER | CENTer | UPPer }

:DISPlay:SWLAN:DDEMod:MView:X[:SCALe]:CPOsition?

Arguments LOWER selects the upper 20 MHz of a 40 MHz channel as the carrier position.
 CENTer selects the center of a 40 MHz channel as the carrier position.
 UPPer selects the lower 20 MHz of a 40 MHz channel as the carrier position.

Measurement Modes DEMSWLAN

Examples :DISPlay:SWLAN:DDEMod:MView:X:SCALe:CPOsition UPPer
 selects the upper 20 MHz of a 40 MHz channel as the carrier position.

Related Commands [:SENSE]:SWLAN:MEASurement

:DISPlay:SWLAN:DDEMod:MView:X[:SCALE]:OFFSet(?)

Sets or queries the minimum horizontal value (left edge) in the main view during the 802.11n (nx1) analysis.

Syntax :DISPlay:SWLAN:DDEMod:MView:X[:SCALE]:OFFSet <value>

:DISPlay:SWLAN:DDEMod:MView:X[:SCALE]:OFFSet?

Arguments <value>::=<Nrf> specifies the minimum horizontal value in the main view. Refer to *Note on Horizontal Scaling* on page 2-184 for setting the scale.

Measurement Modes DEMSWLAN

Examples :DISPlay:SWLAN:DDEMod:MView:X:SCALE:OFFSet -40us
sets the minimum horizontal value to -40 μ s when the main view displays power versus time.

Related Commands [:SENSe]:SWLAN:MEASurement

:DISPlay:SWLAN:DDEMod:MView:X[:SCALE]:PDIVision(?)

Sets or queries the horizontal scale (time per division) for the time domain display in the main view. This command is valid when [:SENSe]:SWLAN:MEASurement is set to PVTime, EVTime, EVSC, PVSC, or FERRor (EVSC and PVSC are for non-OFDM display data).

Syntax :DISPlay:SWLAN:DDEMod:MView:X[:SCALE]:PDIVision <time>

:DISPlay:SWLAN:DDEMod:MView:X[:SCALE]:PDIVision?

Arguments <time>::=<Nrf> specifies the horizontal scale in the main view. Refer to *Note on Horizontal Scaling* on page 2-184 for setting the scale.

Measurement Modes DEMSWLAN

Examples :DISPlay:SWLAN:DDEMod:MView:X:SCALE:PDIVision 10us
sets the horizontal scale to 10 μ s/div.

Related Commands [:SENSe]:SWLAN:MEASurement

:DISPlay:SWLAN:DDEMod:MView:X[:SCALe]:RANGe(?)

Sets or queries the full-scale value of the horizontal axis in the main view during the 802.11n (nx1) analysis.

Syntax :DISPlay:SWLAN:DDEMod:MView:X[:SCALe]:RANGe <value>

:DISPlay:SWLAN:DDEMod:MView:X[:SCALe]:RANGe?

Arguments <value>::=<NRf> specifies a full-scale value of the horizontal axis. Refer to *Note on Horizontal Scaling* on page 2-184 for setting the scale.

Measurement Modes DEMSWLAN

Examples :DISPlay:SWLAN:DDEMod:MView:X:SCALe:RANGe 40us
sets the full-scale value of the horizontal axis to 40 μ s when the main view displays power versus time.

Related Commands [:SENSe]:SWLAN:MEASurement

:DISPlay:SWLAN:DDEMod:MView:Y[:SCALE]:FIT (No Query Form)

Runs auto-scale on the main view during the 802.11n (nx1) analysis. The auto-scale automatically sets the start value and scale of the vertical axis to fit the waveform to the screen.

Syntax :DISPlay:SWLAN:DDEMod:MView:Y[:SCALE]:FIT

Arguments None

Measurement Modes DEMSWLAN

Examples :DISPlay:SWLAN:DDEMod:MView:Y:SCALE:FIT
runs the auto-scale on the main view.

Related Commands [:SENSe]:SWLAN:MEASurement

:DISPlay:SWLAN:DDEMod:MView:Y[:SCALE]:FULL (No Query Form)

Sets the vertical axis in the main view to the default full-scale value during the 802.11n (nx1) analysis.

Syntax :DISPlay:SWLAN:DDEMod:MView:Y[:SCALE]:FULL

Arguments None

Measurement Modes DEMSWLAN

Examples :DISPlay:SWLAN:DDEMod:MView:Y:SCALE:FULL
sets the main view's vertical axis to the default full-scale value.

Related Commands [:SENSe]:SWLAN:MEASurement

:DISPlay:SWLAN:DDEMod:MView:Y[:SCALe]:OFFSet(?)

Sets or queries the minimum vertical value in the main view (bottom) during the 802.11n (nx1) analysis.

Syntax :DISPlay:SWLAN:DDEMod:MView:Y[:SCALe]:OFFSet <value>
 :DISPlay:SWLAN:DDEMod:MView:Y[:SCALe]:OFFSet?

Arguments <value>::=<NRf> specifies the minimum vertical value in the main view. The valid range depends on the display format. Refer to Table D-9 in *Appendix D*.

Measurement Modes DEMSWLAN

Examples :DISPlay:M2WLAN:DDEMod:MView:Y:SCALe:OFFSet -15pct
 sets the minimum vertical value to -15% when the main view displays the EVM versus Time.

Related Commands [:SENSe]:SWLAN:MEASurement

:DISPlay:SWLAN:DDEMod:MView:Y[:SCALe]:PDIVision(?)

Sets or queries the vertical scale (per division) in the time domain display in the main view. This command is valid when [:SENSe]:SWLAN:MEASurement is set to PVTime, EVTime, EVSC, PVSC, or FERRor (EVSC and PVSC are for non-OFDM display data).

Syntax :DISPlay:SWLAN:DDEMod:MView:Y[:SCALe]:PDIVision <value>
 :DISPlay:SWLAN:DDEMod:MView:Y[:SCALe]:PDIVision?

Arguments <value>::=<NRf> specifies the vertical scale. The valid range depends on the display format. Refer to Table D-9 in *Appendix D*.

Measurement Modes DEMSWLAN

Examples :DISPlay:SWLAN:DDEMod:MView:Y:SCALe:PDIVision 10dB
 sets the vertical scale to 10 dB/div.

Related Commands [:SENSe]:SWLAN:MEASurement

:DISPlay:SWLAN:DDEMod:MView:Y[:SCALE]:PWUnit(?)

Selects or queries the unit of power for the delay profile measurement in the main view during the 802.11n (nx1) analysis. This command is valid when [:SENSe]:SWLAN:MEASurement is set to DPRofile (delay profile).

Syntax :DISPlay:SWLAN:DDEMod:MView:Y[:SCALE]:PWUnit { DBM | W }
 :DISPlay:SWLAN:DDEMod:MView:Y[:SCALE]:PWUnit?

Arguments DBM selects dBm for the unit of power.
 W selects watt for the unit of power.

Measurement Modes DEMSWLAN

Examples :DISPlay:SWLAN:DDEMod:MView:Y:SCALE:PWUnit DBM
 selects dBm for the unit of power for the delay profile.

Related Commands [:SENSe]:SWLAN:MEASurement

:DISPlay:SWLAN:DDEMod:MView:Y[:SCALE]:RANGe(?)

Sets or queries full-scale value of the vertical axis in the main view during the 802.11n (nx1) analysis.

Syntax :DISPlay:SWLAN:DDEMod:MView:Y[:SCALE]:RANGe <value>

:DISPlay:SWLAN:DDEMod:MView:Y[:SCALE]:RANGe?

Arguments <value>: :=<Nrf> specifies a full-scale value of the vertical axis. The valid setting range depends on the display format. Refer to Table D-9 in *Appendix D*.

Measurement Modes DEMSWLAN

Examples :DISPlay:SWLAN:DDEMod:MView:Y:SCALE:RANGe 20dB
sets full-scale value of the vertical axis to 20 dB when the the main view displays power versus time.

Related Commands [:SENSe]:SWLAN:MEASurement

:DISPlay:SWLAN:DDEMod:MView:Y[:SCALe]:UNIT(?)

Selects or queries the unit of the vertical axis for the frequency error measurement in the main view during the 802.11n (nx1) analysis. This command is valid when [:SENSe]:SWLAN:MEASurement is set to FERRor (frequency error).

Syntax :DISPlay:SWLAN:DDEMod:MView:Y[:SCALe]:UNIT { HZ | PPM }
 :DISPlay:SWLAN:DDEMod:MView:Y[:SCALe]:UNIT?

Arguments HZ selects Hz for the unit of the vertical axis.
 PPM selects ppm for the unit of the vertical axis.

Measurement Modes DEMSWLAN

Examples :DISPlay:SWLAN:DDEMod:MView:Y:SCALe:UNIT HZ
 selects Hz for the unit of the vertical axis in the frequency error measurement.

Related Commands [:SENSe]:SWLAN:MEASurement

:DISPlay:SWLAN:DDEMod:SVIew:FORMat(?)

Selects or queries the display format of the subview in the 802.11n (nx1) analysis.

Syntax :DISPlay:SWLAN:DDEMod:SVIew:FORMat { SPECTrum | ATGRam
| ATFuction | PTGRam | PTFunction | DGRam | DPRofile | CONSte
| VECTor | EVTime | PVTime | SCConste | SCVector | EVSC | PVSC
| FERRor | OFLatness | OLINearity | DOLinearity | STABLE }
:DISPlay:SWLAN:DDEMod:SVIew:FORMat?

Arguments The arguments and display formats are listed below:

Table 2-58: Subview display formats, nx1

Argument	Display format
SPECTrum	Spectrum
ATGRam	Amplitude transfogram
ATFunction	Amplitude transfer function
PTGRam	Phase transfogram
PTFunction	Phase transfer function
DGRam	Delayogram
DPRofile	Delay pofile
CONSte	Constellation
VECTor	Vector
EVTime	EVM versus Time
PVTime	Power versus Time
SCConste	Subcarrier constellation
SCVector	Subcarrier vector
EVSC	EVM versus Subcarrier
PVSC	Power versus Subcarrier
FERRor	Frequency error
OFLatness	OFDM flatness
OLINearity	OFDM linearity (vector display)
DOLinearity	OFDM linearity (dot display)
STABLE	Symbol table

Measurement Modes DEMSWLAN

Examples :DISPlay:SWLAN:DDEMod:SVIew:FORMat CONSte
displays the constellation in the subview.

Related Commands [:SENSe]:SWLAN:MEASurement

:DISPlay:SWLAN:DDEMod:SVIew:MCONtent(?)

Selects or queries the measurement content of the subview in the 802.11n (nx1) analysis. This command is valid when :DISPlay:SWLAN:DDEMod:SVIew:FORMat is set to EVTime or EVSC.

Syntax :DISPlay:SWLAN:DDEMod:SVIew:MCONtent { EVM | MERRor | PERRor }
:DISPlay:SWLAN:DDEMod:SVIew:MCONtent?

Arguments EVM selects the EVM.
MERRor selects the magnitude (amplitude) error.
PERRor selects the phase error.

Measurement Modes DEMSWLAN

Examples :DISPlay:SWLAN:DDEMod:SVIew:MCONtent EVM
selects the EVM for the subview content.

Related Commands :DISPlay:SWLAN:DDEMod:SVIew:FORMat

:DISPlay:SWLAN:DDEMod:SVIew:RADix(?)

Selects or queries the base of symbols in the subview during the 802.11n (nx1) analysis. This command is valid when :DISPlay:SWLAN:DDEMod:SVIew:FORMat is set to STABLE (symbol table).

Syntax :DISPlay:SWLAN:DDEMod:SVIew:RADix
{ BINary | OCTal | HEXadecimal }
:DISPlay:SWLAN:DDEMod:SVIew:RADix?

Arguments BINary selects binary notation.
OCTal selects octal notation.
HEXadecimal selects hexadecimal notation.

Measurement Modes DEMSWLAN

Examples :DISPlay:SWLAN:DDEMod:SVIew:RADix BINary
selects binary notation for the symbol table.

Related Commands :DISPlay:SWLAN:DDEMod:SVIew:FORMat

:DISPlay:SWLAN:DDEMod:SVIew:X[:SCALe]:CHANnel:BANDwidth|:BWIDth(?)

Sets or queries the channel bandwidth for the OFDM flatness measurement in the subview during the 802.11n (nx1) analysis. This command is valid when :DISPlay:SWLAN:DDEMod:SVIew:FORMat is set to OFLatness.

Syntax :DISPlay:SWLAN:DDEMod:SVIew:X[:SCALe]:CHANnel:BANDwidth
 |:BWIDth <value>

 :DISPlay:SWLAN:DDEMod:SVIew:X[:SCALe]:CHANnel:BANDwidth
 |:BWIDth?

Arguments <value>::=<NRf> specifies the channel bandwidth.
 Setting value: 20 MHz or 40 MHz.

Measurement Modes DEMSWLAN

Examples :DISPlay:SWLAN:DDEMod:SVIew:X:SCALe:CHANnel:BANDwidth 40MHz
 sets the channel bandwidth to 40 MHz for the OFDM flatness measurement.

Related Commands :DISPlay:SWLAN:DDEMod:SVIew:FORMat

:DISPlay:SWLAN:DDEMod:SVIew:X[:SCALe]:CPOsition(?)

Selects or queries the carrier position for the 20 MHz channel in the OFDM flatness measurement in the subview. This command is valid when :DISPlay:SWLAN:DDEMod:SVIew:FORMat is set to OFLatness.

Syntax :DISPlay:SWLAN:DDEMod:SVIew:X[:SCALe]:CPOsition
{ LOWer | CENTer | UPPer }

:DISPlay:SWLAN:DDEMod:SVIew:X[:SCALe]:CPOsition

Arguments LOWer selects the upper 20 MHz of a 40 MHz channel as the carrier position.

CENTer selects the center of a 40 MHz channel as the carrier position.

UPPer selects the lower 20 MHz of a 40 MHz channel as the carrier position.

Measurement Modes DEMSWLAN

Examples :DISPlay:SWLAN:DDEMod:SVIew:X:SCALe:CPOsition UPPer
displays the results for the upper 20 MHz channel of a 40 MHz channel.

Related Commands :DISPlay:SWLAN:DDEMod:SVIew:FORMat

:DISPlay:SWLAN:DDEMod:SVIew:X[:SCALe]:OFFSet(?)

Sets or queries the minimum horizontal value (left edge) in the subview during the 802.11n (nx1) analysis.

Syntax :DISPlay:SWLAN:DDEMod:SVIew:X[:SCALe]:OFFSet <value>
 :DISPlay:SWLAN:DDEMod:SVIew:X[:SCALe]:OFFSet?

Arguments <value>::=<NRf> specifies the minimum horizontal value in the subview. Refer to *Note on Horizontal Scaling* on page 2-184 for setting the scale.

Measurement Modes DEMSWLAN

Examples :DISPlay:SWLAN:DDEMod:SVIew:X:SCALe:OFFSet -2.5
 sets the minimum horizontal value to -2.5 when the subview displays the constellation.

Related Commands :DISPlay:SWLAN:DDEMod:SVIew:FORMat

:DISPlay:SWLAN:DDEMod:SVIew:X[:SCALe]:PDIVision(?)

Sets or queries the horizontal scale (time per division) for the time domain display in the subview. This command is valid when DISPlay:SWLAN:DDEMod:SVIew:FORMat is set to PVTime, EVTime, EVSC, PVSC, or FERRor (EVSC and PVSC are for non-OFDM display data).

Syntax :DISPlay:SWLAN:DDEMod:SVIew:X[:SCALe]:PDIVision <time>
 :DISPlay:SWLAN:DDEMod:SVIew:X[:SCALe]:PDIVision?

Arguments <time>::=<NRf> specifies the horizontal scale in the subview. Refer to *Note on Horizontal Scaling* on page 2-184 for setting the scale.

Measurement Modes DEMSWLAN

Examples :DISPlay:SWLAN:DDEMod:SVIew:X:SCALe:PDIVision 10us
 sets the horizontal scale to 10 μ s/div.

Related Commands :DISPlay:SWLAN:DDEMod:SVIew:FORMat

:DISPlay:SWLAN:DDEMod:SVIew:X[:SCALE]:RANGe(?)

Sets or queries full-scale value of the horizontal axis in the subview during the 802.11n (nx1) analysis.

Syntax :DISPlay:SWLAN:DDEMod:SVIew:X[:SCALE]:RANGe <value>
 :DISPlay:SWLAN:DDEMod:SVIew:X[:SCALE]:RANGe?

Arguments <value>::=<NRf> specifies a full-scale value of the horizontal axis.
Refer to *Note on Horizontal Scaling* on page 2-184 for setting the scale.

Measurement Modes DEMSWLAN

Examples :DISPlay:SWLAN:DDEMod:SVIew:X:SCALE:RANGe 40us
sets the full-scale value of the horizontal axis to 40 μ s when the subview displays power versus time.

Related Commands :DISPlay:SWLAN:DDEMod:SVIew:FORMat

:DISPlay:SWLAN:DDEMod:SVIew:Y[:SCALe]:FIT (No Query Form)

Runs auto-scale on the subview during the 802.11n (nx1) analysis.
The auto-scale automatically sets the start value and scale of the vertical axis to fit the waveform to the screen.

Syntax :DISPlay:SWLAN:DDEMod:SVIew:Y[:SCALe]:FIT

Arguments None

Measurement Modes DEMSWLAN

Examples :DISPlay:SWLAN:DDEMod:SVIew:Y:SCALe:FIT
runs the auto-scale on the subview.

Related Commands :DISPlay:SWLAN:DDEMod:SVIew:FORMat

:DISPlay:SWLAN:DDEMod:SVIew:Y[:SCALe]:FULL (No Query Form)

Sets the vertical axis in the subview to the default full-scale value during the 802.11n (nx1) analysis.

Syntax :DISPlay:SWLAN:DDEMod:SVIew:Y[:SCALe]:FULL

Arguments None

Measurement Modes DEMSWLAN

Examples :DISPlay:SWLAN:DDEMod:SVIew:Y:SCALe:FULL
sets the vertical axis in the subview to the default full-scale value.

Related Commands :DISPlay:SWLAN:DDEMod:SVIew:FORMat

:DISPlay:SWLAN:DDEMod:SVIew:Y[:SCALe]:OFFSet(?)

Sets or queries the minimum vertical value (bottom) in the subview during the 802.11n (nx1) analysis.

Syntax :DISPlay:SWLAN:DDEMod:SVIew:Y[:SCALe]:OFFSet <value>
 :DISPlay:SWLAN:DDEMod:SVIew:Y[:SCALe]:OFFSet?

Arguments <value>::=<Nrf> specifies the minimum vertical value in the subview. The valid setting range depends on the display format. Refer to Table D-9 in *Appendix D*.

Measurement Modes DEMSWLAN

Examples :DISPlay:SWLAN:DDEMod:SVIew:Y:SCALe:OFFSet -100
 sets the minimum vertical value to -100 dBm when the subview displays power versus time.

Related Commands :DISPlay:SWLAN:DDEMod:SVIew:FORMat

:DISPlay:SWLAN:DDEMod:SVIew:Y[:SCALe]:PDIVision(?)

Sets or queries the vertical scale (per division) for the time domain display in the subview. This command is valid when :DISPlay:SWLAN:DDEMod:SVIew:FORMat is set to PVTime, EVTime, EVSC, PVSC, or FERRor (EVSC and PVSC are for non-OFDM display data).

Syntax :DISPlay:SWLAN:DDEMod:SVIew:Y[:SCALe]:PDIVision <value>
 :DISPlay:SWLAN:DDEMod:SVIew:Y[:SCALe]:PDIVision?

Arguments <value>: :=<NRf> specifies the vertical scale in the subview.
 The valid setting range depends on the display format. Refer to Table D-9 in *Appendix D*.

Measurement Modes DEMSWLAN

Examples :DISPlay:SWLAN:DDEMod:SVIew:Y:SCALe:PDIVision 5
 sets the vertical scale to 5 dB/div when the subview displays power versus time.

Related Commands :DISPlay:SWLAN:DDEMod:SVIew:FORMat

:DISPlay:SWLAN:DDEMod:SVIew:Y[:SCALe]:PWUNit(?)

Selects or queries the unit of power for the delay profile measurement in the subview during the 802.11n (nx1) analysis. This command is valid when :DISPlay:SWLAN:DDEMod:SVIew:FORMat is set to DPRofile (delay profile).

Syntax :DISPlay:SWLAN:DDEMod:SVIew:Y[:SCALe]:PWUNit { DBM | W }
:DISPlay:SWLAN:DDEMod:SVIew:Y[:SCALe]:PWUNit?

Arguments DBM selects dBm for the unit of power.
W selects watt for the unit of power.

Measurement Modes DEMSWLAN

Examples :DISPlay:SWLAN:DDEMod:SVIew:Y:SCALe:PWUNit DBM
selects dBm for the unit of power for the delay profile.

Related Commands :DISPlay:SWLAN:DDEMod:SVIew:FORMat

:DISPlay:SWLAN:DDEMod:SVIew:Y[:SCALe]:RANGe(?)

Sets or queries full-scale value of the vertical axis in the subview during the 802.11n (nx1) analysis.

Syntax :DISPlay:SWLAN:DDEMod:SVIew:Y[:SCALe]:RANGe <value>

:DISPlay:SWLAN:DDEMod:SVIew:Y[:SCALe]:RANGe?

Arguments <value>: :=<NRf> specifies a full-scale value of the vertical axis. The valid setting range depends on the display format. Refer to Table D-9 in *Appendix D*.

Measurement Modes DEMSWLAN

Examples :DISPlay:SWLAN:DDEMod:SVIew:Y:SCALe:RANGe 100
sets full-scale value of the vertical axis to 100 dB when the subview displays power versus time.

Related Commands :DISPlay:SWLAN:DDEMod:SVIew:FORMat

:DISPlay:SWLAN:DDEMod:SVIew:Y[:SCALe]:UNIT(?)

Sets or queries the unit of the vertical axis for the frequency error measurement in the subview during the 802.11n (nx1) analysis.
This command is valid when :DISPlay:SWLAN:DDEMod:SVIew:FORMat is set to FERRor (frequency error).

Syntax :DISPlay:SWLAN:DDEMod:SVIew:Y[:SCALe]:UNIT { HZ | PPM }
:DISPlay:SWLAN:DDEMod:SVIew:Y[:SCALe]:UNIT?

Arguments HZ selects Hz for the unit of the vertical axis.
PPM selects ppm for the unit of the vertical axis.

Measurement Modes DEMSWLAN

Examples :DISPlay:SWLAN:DDEMod:SVIew:Y:SCALe:UNIT HZ
selects Hz for the unit of the vertical axis in the frequency error measurement.

Related Commands :DISPlay:SWLAN:DDEMod:SVIew:FORMat

:DISPlay:SWLAN:SPECTrum Subgroup

WLAN, Option 29 Only

The :DISPlay:SWLAN:SPECTrum commands control the display for the spectrum mask measurement in the IEEE802.11n (nx1) analysis.

NOTE. To use a command from this group, you must have selected DEMSWLAN (IEEE802.11n (nx1) analysis) in the :INSTRument[:SElect] command.

Command Tree	Header	Parameter
	:DISPlay	
	:SWLAN	
	:SPECTrum	
	:X	
	[:SCALE]	
	:OFFSet	<frequency>
	:PDIVision	<frequency>
	:Y	
	[:SCALE]	
	:FIT	
	:FULL	
	:OFFSet	<amplitude>
	:PDIVision	<amplitude>

:DISPlay:SWLAN:SPECTrum:X[:SCALe]:OFFSet(?)

Sets or queries the minimum horizontal, or frequency, value (left edge) in the spectrum view.

Syntax :DISPlay:SWLAN:SPECTrum:X[:SCALe]:OFFSet <freq>
 :DISPlay:SWLAN:SPECTrum:X[:SCALe]:OFFSet?

Arguments <freq>::=<NRf> specifies the minimum horizontal value in the spectrum view. Refer to *Note on Horizontal Scaling* on page 2-184 for setting the scale.

Measurement Modes DEMSWLAN

Examples :DISPlay:SWLAN:SPECTrum:X:SCALe:OFFSet 100MHz
 sets the minimum horizontal value to 100 MHz.

:DISPlay:SWLAN:SPECTrum:X[:SCALe]:PDIVision(?)

Sets or queries the horizontal scale (frequency per division) in the spectrum view.

Syntax :DISPlay:SWLAN:SPECTrum:X[:SCALe]:PDIVision <freq>
 :DISPlay:SWLAN:SPECTrum:X[:SCALe]:PDIVision?

Arguments <freq>::=<NRf> specifies the horizontal scale (per division). Refer to *Note on Horizontal Scaling* on page 2-184 for setting the scale.

Measurement Modes DEMSWLAN

Examples :DISPlay:SWLAN:SPECTrum:X:SCALe:PDIVision 100.0E+3
 sets the horizontal scale to 100 kHz/div.

:DISPlay:SWLAN:SPECTrum:Y[:SCALE]:FIT (No Query Form)

Runs auto-scale on the spectrum view.

The auto-scale automatically sets the start value and scale of the vertical axis to fit the waveform to the screen.

Syntax :DISPlay:SWLAN:SPECTrum:Y[:SCALE]:FIT

Arguments None

Measurement Modes DEMSWLAN

Examples :DISPlay:SWLAN:SPECTrum:Y:SCALE:FIT
runs the auto-scale on the spectrum view.

:DISPlay:SWLAN:SPECTrum:Y[:SCALE]:FULL (No Query Form)

Sets the vertical axis to the default full-scale value in the spectrum view.

Syntax :DISPlay:SWLAN:SPECTrum:Y[:SCALE]:FULL

Arguments None

Measurement Modes DEMSWLAN

Examples :DISPlay:SWLAN:SPECTrum:Y:SCALE:FULL
sets the vertical axis to the default full-scale value in the spectrum view.

:DISPlay:SWLAN:SPECTrum:Y[:SCALe]:OFFSet(?)

Sets or queries the minimum vertical, or amplitude, value (bottom) in the spectrum view.

Syntax :DISPlay:SWLAN:SPECTrum:Y[:SCALe]:OFFSet <amp1>
:DISPlay:SWLAN:SPECTrum:Y[:SCALe]:OFFSet?

Arguments <amp1>::=<NRf> sets the minimum vertical value. Range: -200 to 0 dBm.

Measurement Modes DEMSWLAN

Examples :DISPlay:SWLAN:SPECTrum:Y:SCALe:OFFSet -100
sets the minimum vertical value to -100 dBm.

:DISPlay:SWLAN:SPECTrum:Y[:SCALe]:PDIVision(?)

Sets or queries the vertical scale (amplitude per division) in the spectrum view.

Syntax :DISPlay:SWLAN:SPECTrum:Y[:SCALe]:PDIVision <amp1>
:DISPlay:SWLAN:SPECTrum:Y[:SCALe]:PDIVision?

Arguments <amp1>::=<NRf> specifies the vertical scale in the spectrum view.
Range: 0 to 10 dB/div.

Measurement Modes DEMSWLAN

Examples :DISPlay:SWLAN:SPECTrum:Y:SCALe:PDIVision 10
sets the vertical scale to 10 dB/div.

:DISPlay:SWLAN:TFRequency Subgroup

WLAN, Option 29 Only

The :DISPlay:SWLAN:TFRequency commands control the following three-dimensional views in the IEEE802.11n (nx1) analysis.

- Transfogram (Amplitude and Phase)
- Delayogram

NOTE. *To use a command from this group, you must have selected DEMSWLAN (IEEE802.11n (nx1) analysis) in the :INSTRument[:SElect] command.*

Command Tree	Header	Parameter
	:DISPlay	
	:SWLAN	
	:TFRequency	
	:ATGRam	
	:COLor	
	[:SCALE]	
	:OFFSet	<numeric_value>
	:RANge	<numeric_value>
	:X	
	[:SCALE]	
	:OFFSet	<numeric_value>
	:RANge	<numeric_value>
	:Y	
	[:SCALE]	
	:OFFSet	<numeric_value>
	:PLINe	<numeric_value>
	:DGRam	
	:COLor	
	[:SCALE]	
	:OFFSet	<numeric_value>
	:RANge	<numeric_value>
	:X	
	[:SCALE]	
	:OFFSet	<numeric_value>
	:RANge	<numeric_value>
	:Y	
	[:SCALE]	
	:OFFSet	<numeric_value>
	:PLINe	<numeric_value>
	:PTGRam	
	:COLor	
	[:SCALE]	
	:OFFSet	<numeric_value>
	:RANge	<numeric_value>
	:X	
	[:SCALE]	
	:OFFSet	<numeric_value>
	:RANge	<numeric_value>
	:Y	
	[:SCALE]	
	:OFFSet	<numeric_value>
	:PLINe	<numeric_value>

:DISPlay:SWLAN:TFRrequency:ATGRam:COLor[:SCALE]:OFFSet(?)

Sets or queries the minimum value (bottom edge) of the color axis (amplitude) in the amplitude transfogram.

Syntax :DISPlay:SWLAN:TFRrequency:ATGRam:COLor[:SCALE]:OFFSet <value>

 :DISPlay:SWLAN:TFRrequency:ATGRam:COLor[:SCALE]:OFFSet?

Arguments <value>::=<NRf> specifies the minimum color-axis value.
Range: -200 to 0 dBm.

Measurement Modes DEMSWLAN

Examples :DISPlay:SWLAN:TFRrequency:ATGRam:COLor:SCALE:OFFSet -100
sets the minimum color-axis value to -100 dBm.

:DISPlay:SWLAN:TFRrequency:ATGRam:COLor[:SCALE]:RANGe(?)

Sets or queries the full-scale value of the color axis (amplitude) in the amplitude transfogram.

Syntax :DISPlay:SWLAN:TFRrequency:ATGRam:COLor[:SCALE]:RANGe <value>

 :DISPlay:SWLAN:TFRrequency:ATGRam:COLor[:SCALE]:RANGe?

Arguments <value>::={ 10 | 20 | 50 | 100 } [dB] specifies the full-scale value of the color axis.

Measurement Modes DEMSWLAN

Examples :DISPlay:SWLAN:TFRrequency:ATGRam:COLor:SCALE:RANGe 100
sets the full-scale value of the color axis to 100 dB.

:DISPlay:SWLAN:TFrequency:ATGRam:X[:SCALe]:OFFSet(?)

Sets or queries the minimum value (left edge) of the horizontal axis (subcarrier number) in the amplitude transfogram.

Syntax :DISPlay:SWLAN:TFrequency:ATGRam:X[:SCALe]:OFFSet <value>
:DISPlay:SWLAN:TFrequency:ATGRam:X[:SCALe]:OFFSet?

Arguments <value>::=<NRf> specifies the minimum horizontal value.
Range: -64 to 8.

Measurement Modes DEMSWLAN

Examples :DISPlay:SWLAN:TFrequency:ATGRam:X:SCALe:OFFSet -28
sets the minimum horizontal value to the subcarrier #-28.

:DISPlay:SWLAN:TFrequency:ATGRam:X[:SCALe]:RANGe(?)

Sets or queries the full-scale value of the horizontal axis (subcarrier number) in the amplitude transfogram.

Syntax :DISPlay:SWLAN:TFrequency:ATGRam:X[:SCALe]:RANGe <value>
:DISPlay:SWLAN:TFrequency:ATGRam:X[:SCALe]:RANGe?

Arguments <value>::=<NRf> specifies the horizontal full-scale.
Range: 16 to 128.

Measurement Modes DEMSWLAN

Examples :DISPlay:SWLAN:TFrequency:ATGRam:X:SCALe:RANGe 64
sets the horizontal full-scale to 64 subcarriers.

:DISPlay:SWLAN:TFRrequency:ATGRam:Y[:SCALe]:OFFSet(?)

Sets or queries the minimum value (bottom edge) of the vertical axis (packet number) in the amplitude transfogram.

Syntax :DISPlay:SWLAN:TFRrequency:ATGRam:Y[:SCALe]:OFFSet <value>

:DISPlay:SWLAN:TFRrequency:ATGRam:Y[:SCALe]:OFFSet?

Arguments <value> ::= <NR1> specifies the minimum vertical value.
Range: -[(the number of packets in the analysis range) - 1] to 0.
Zero (0) represents the latest packet.

Measurement Modes DEMSWLAN

Examples :DISPlay:SWLAN:TFRrequency:ATGRam:Y:SCALe:OFFSet -100
sets the minimum vertical value to Packet # -100.

:DISPlay:SWLAN:TFRrequency:ATGRam:Y[:SCALe]:PLINe(?)

Sets or queries the vertical scale (the number of packets per line) in the amplitude transfogram. Packets are thinned out from all the acquired framed data at intervals of the number of packets specified in this command, before the amplitude transfogram is displayed. For example, if you set the argument to 5, the data will be displayed every 5 packets.

Syntax :DISPlay:SWLAN:TFRrequency:ATGRam:Y[:SCALe]:PLINe <value>

:DISPlay:SWLAN:TFRrequency:ATGRam:Y[:SCALe]:PLINe?

Arguments <value> ::= <NR1> specifies the vertical scale in the amplitude transfogram.
Range: 1 to 1024 packets per line.

Measurement Modes DEMSWLAN

Examples :DISPlay:SWLAN:TFRrequency:ATGRam:Y:SCALe:PLINe 5
displays the data in the amplitude transfogram every 5 packets.

:DISPlay:SWLAN:TFRrequency:DGRam:COLor[:SCALE]:OFFSet(?)

Sets or queries the minimum value (bottom edge) of the color axis (amplitude) in the delayogram.

Syntax :DISPlay:SWLAN:TFRrequency:DGRam:COLor[:SCALE]:OFFSet <value>
:DISPlay:SWLAN:TFRrequency:DGRam:COLor[:SCALE]:OFFSet?

Arguments <value>::=<NRf> specifies the minimum color-axis value.
Range: -200 to 0 dBm.

Measurement Modes DEMSWLAN

Examples :DISPlay:SWLAN:TFRrequency:DGRam:COLor:SCALE:OFFSet -100
sets the minimum color-axis value to -100 dBm.

:DISPlay:SWLAN:TFRrequency:DGRam:COLor[:SCALE]:RANGe(?)

Sets or queries the full-scale value of the color axis (amplitude) in the delayogram.

Syntax :DISPlay:SWLAN:TFRrequency:DGRam:COLor[:SCALE]:RANGe <value>
:DISPlay:SWLAN:TFRrequency:DGRam:COLor[:SCALE]:RANGe?

Arguments <value>::={ 10 | 20 | 50 | 100 } [dB] specifies the full-scale value of the color axis.

Measurement Modes DEMSWLAN

Examples :DISPlay:SWLAN:TFRrequency:DGRam:COLor:SCALE:RANGe 50
sets full-scale value of the color axis to 50 dB.

:DISPlay:SWLAN:TFRrequency:DGRam:X[:SCALE]:OFFSet(?)

Sets or queries the minimum value (left edge) of the horizontal axis (time) in the delayogram.

Syntax :DISPlay:SWLAN:TFRrequency:DGRam:X[:SCALE]:OFFSet <time>

 :DISPlay:SWLAN:TFRrequency:DGRam:X[:SCALE]:OFFSet?

Arguments <time> ::= <NRf> specifies the minimum horizontal value in the delayogram.
Range: $-S_0/2$ to $[S_0/2 - (\text{horizontal full scale})]$ (sec).
Where S_0 is the initial horizontal full scale.

Measurement Modes DEMSWLAN

Examples :DISPlay:SWLAN:TFRrequency:DGRam:X:SCALE:OFFSet -2.5ns
sets the minimum horizontal value to -2.5 ns.

:DISPlay:SWLAN:TFRrequency:DGRam:X[:SCALE]:RANGe(?)

Sets or queries the full-scale value of the horizontal axis (time) in the delayogram.

Syntax :DISPlay:SWLAN:TFRrequency:DGRam:X[:SCALE]:RANGe <time>

 :DISPlay:SWLAN:TFRrequency:DGRam:X[:SCALE]:RANGe?

Arguments <time> ::= <NRf> specifies the full-scale value of the horizontal axis.
Range: $S_0/16$ to S_0 (sec), where S_0 is the initial horizontal full scale.

Measurement Modes DEMSWLAN

Examples :DISPlay:SWLAN:TFRrequency:DGRam:X:SCALE:RANGe 5ns
sets the horizontal full-scale to 5 ns.

:DISPlay:SWLAN:TFRrequency:DGRam:Y[:SCALE]:OFFSet(?)

Sets or queries the minimum value (bottom edge) of the vertical axis (packet number) in the delayogram.

Syntax :DISPlay:SWLAN:TFRrequency:DGRam:Y[:SCALE]:OFFSet <value>
:DISPlay:SWLAN:TFRrequency:DGRam:Y[:SCALE]:OFFSet?

Arguments <value>::=<NR1> specifies the minimum vertical value.
Range: -[(the number of packets in the analysis range) - 1] to 0.
Zero (0) represents the latest packet.

Measurement Modes DEMSWLAN

Examples :DISPlay:SWLAN:TFRrequency:DGRam:Y:SCALE:OFFSet -100
sets the minimum vertical value to Packet # -100.

:DISPlay:SWLAN:TFRrequency:DGRam:Y[:SCALE]:PLINE(?)

Sets or queries the vertical scale (the number of packets per line) in the delayogram. Packets are thinned out from all the acquired framed data at intervals of the number of packets specified in this command, before the delayogram is displayed. For example, if you set the argument to 5, the data will be displayed every 5 packets.

Syntax :DISPlay:SWLAN:TFRrequency:DGRam:Y[:SCALE]:PLINE <value>
:DISPlay:SWLAN:TFRrequency:DGRam:Y[:SCALE]:PLINE?

Arguments <value>::=<NR1> specifies the vertical scale in the delayogram.
Range: 1 to 1024 packets per line.

Measurement Modes DEMSWLAN

Examples :DISPlay:SWLAN:TFRrequency:DGRam:Y:SCALE:PLINE 5
displays the data in the delayogram every 5 packets.

:DISPlay:SWLAN:TFRrequency:PTGRam:COLor[:SCALE]:OFFSet(?)

Sets or queries the minimum value (bottom edge) of the color axis (phase) in the phase transfogram.

Syntax :DISPlay:SWLAN:TFRrequency:PTGRam:COLor[:SCALE]:OFFSet <value>

:DISPlay:SWLAN:TFRrequency:PTGRam:COLor[:SCALE]:OFFSet?

Arguments <value>::=<NRf> specifies the minimum color-axis value.
Range: -1200 to 400°.

Measurement Modes DEMSWLAN

Examples :DISPlay:SWLAN:TFRrequency:PTGRam:COLor:SCALE:OFFSet -100
sets the minimum color-axis value to -100°.

:DISPlay:SWLAN:TFRrequency:PTGRam:COLor[:SCALE]:RANGe(?)

Sets or queries the full-scale value of the color axis (phase) in the phase transfogram.

Syntax :DISPlay:SWLAN:TFRrequency:PTGRam:COLor[:SCALE]:RANGe <value>

:DISPlay:SWLAN:TFRrequency:PTGRam:COLor[:SCALE]:RANGe?

Arguments <value>::=<NRf> specifies full-scale value of the color axis.
Range: 800 μ to 800°.

Measurement Modes DEMSWLAN

Examples :DISPlay:SWLAN:TFRrequency:PTGRam:COLor:SCALE:RANGe 100
sets the full-scale value of the color axis to 100°.

:DISPlay:SWLAN:TFrequency:PTGRam:X[:SCALe]:OFFSet(?)

Sets or queries the minimum value (left edge) of the horizontal axis (subcarrier number) in the phase transfogram.

Syntax :DISPlay:SWLAN:TFrequency:PTGRam:X[:SCALe]:OFFSet <value>

:DISPlay:SWLAN:TFrequency:PTGRam:X[:SCALe]:OFFSet?

Arguments <value>::=<NRf> specifies the minimum horizontal value.
Range: -64 to 8.

Measurement Modes DEMSWLAN

Examples :DISPlay:SWLAN:TFrequency:PTGRam:X:SCALe:OFFSet -28
sets the minimum horizontal value to the subcarrier #-28.

:DISPlay:SWLAN:TFrequency:PTGRam:X[:SCALe]:RANGe(?)

Sets or queries the full-scale value of the horizontal axis (subcarrier number) in the phase transfogram.

Syntax :DISPlay:SWLAN:TFrequency:PTGRam:X[:SCALe]:RANGe <value>

:DISPlay:SWLAN:TFrequency:PTGRam:X[:SCALe]:RANGe?

Arguments <value>::=<NRf> specifies the horizontal full-scale.
Range: 16 to 128.

Measurement Modes DEMSWLAN

Examples :DISPlay:SWLAN:TFrequency:PTGRam:X:SCALe:RANGe 64
sets the horizontal full-scale to 64 subcarriers.

:DISPlay:SWLAN:TFrequency:PTGRam:Y[:SCALe]:OFFSet(?)

Sets or queries the minimum value (bottom edge) of the vertical axis (packet number) in the phase transfoqram.

Syntax :DISPlay:SWLAN:TFrequency:PTGRam:Y[:SCALe]:OFFSet <value>

:DISPlay:SWLAN:TFrequency:PTGRam:Y[:SCALe]:OFFSet?

Arguments <value>::=<NR1> specifies the minimum vertical value.
Range: -[(the number of packets in the analysis range) - 1] to 0.
Zero (0) represents the latest packet.

Measurement Modes DEMSWLAN

Examples :DISPlay:SWLAN:TFrequency:PTGRam:Y:SCALe:OFFSet -100
sets the minimum vertical value to Packet # -100.

:DISPlay:SWLAN:TFrequency:PTGRam:Y[:SCALe]:PLINe(?)

Sets or queries the vertical scale (the number of packets per line) in the phase transfoqram. Packets are thinned out from all the acquired framed data at intervals of the number of packets specified in this command, before the amplitude transfoqram is displayed. For example, if you set the argument to 5, the data will be displayed every 5 packets.

Syntax :DISPlay:SWLAN:TFrequency:PTGRam:Y[:SCALe]:PLINe <value>

:DISPlay:SWLAN:TFrequency:PTGRam:Y[:SCALe]:PLINe?

Arguments <value>::=<NR1> specifies the vertical scale in the phase transfoqram.
Range: 1 to 1024 packets per line.

Measurement Modes DEMSWLAN

Examples :DISPlay:SWLAN:TFrequency:PTGRam:Y:SCALe:PLINe 5
displays the data in the phase transfoqram every 5 packets.

:DISPlay:WLAN:DDEMod Subgroup

WLAN, Option 29 Only

The :DISPlay:WLAN:DDEMod commands control display of the main view and subview for the IEEE802.11n a/b/g analysis.

NOTE. To use a command from this group, you must have selected DEMWLAN (WLAN analysis) in the :INSTrument[:SElect] command.

To control spectrum display in the Spectrum Mask measurement, use the :DISPlay:WLAN:SPECTrum commands.

To select the measurement item in the WLAN analysis, use the [:SENSe]:WLAN:MEASurement command.

Command Tree	Header	Parameter
	:DISPlay	
	:WLAN	
	:DDEMod	
	:MView	
	:FORMat	OLINearity DOLinearity
	:MCONtent	EVM MERRor PERRor
	:RADix	BINary OCTal HEXadecimal
	:X	
	[:SCALE]	
	:OFFSet	<numeric_value>
	:PDIVision	<time>
	:RANGe	<numeric_value>
	:Y	
	[:SCALE]	
	:FIT	
	:FULL	
	:OFFSet	<numeric_value>
	:PDIVision	<amplitude>
	:RANGe	<numeric_value>
	:SView	
	:FORMat	SPECTrum PVTime EVTime CONSTe VECTor PVSC EVSC SCConste SCVector FERRor OFLatness OLINearity DOLinearity STABle PON POFF
	:MCONtent	EVM MERRor PERRor
	:RADix	BINary OCTal HEXadecimal
	:X	
	[:SCALE]	
	:OFFSet	<numeric_value>
	:PDIVision	<time>
	:RANGe	<numeric_value>
	:Y	
	[:SCALE]	
	:FIT	
	:FULL	
	:OFFSet	<numeric_value>
	:PDIVision	<amplitude>
	:RANGe	<numeric_value>

:DISPlay:WLAN:DDEMod:MVlew:FORMat(?)

Selects or queries the display format of the main view in the OFDM linearity measurement. This command is valid when [:SENSe]:WLAN:MEASurement is set to OLINearity.

Syntax :DISPlay:WLAN:DDEMod:MVlew:FORMat { OLINearity | DOLinearity }
 :DISPlay:WLAN:DDEMod:MVlew:FORMat?

Arguments OLINearity selects vector display for the OFDM linearity measurement (default).

DOLinearity selects dot display for the OFDM linearity measurement.

Measurement Modes DEM WLAN

Examples :DISPlay:WLAN:DDEMod:MVlew:FORMat OLINearity
 selects vector display for the OFDM linearity measurement.

Related Commands [:SENSe]:WLAN:MEASurement

:DISPlay:WLAN:DDEMod:MView:MCONTENT(?)

Selects or queries the measurement content of the main view in the IEEE802.11a/b/g analysis. This command is valid when [:SENSe]:WLAN:MEASurement is set to EVTime or EVSC.

Syntax :DISPlay:WLAN:DDEMod:MView:MCONTENT { EVM | MERRor | PERRor }
 :DISPlay:WLAN:DDEMod:MView:MCONTENT?

Arguments EVM selects the EVM.
 MERRor selects the magnitude (amplitude) error.
 PERRor selects the phase error.

Measurement Modes DEMWLAN

Examples :DISPlay:WLAN:DDEMod:MView:MCONTENT EVM
 selects the EVM for the main view content.

Related Commands [:SENSe]:WLAN:MEASurement

:DISPlay:WLAN:DDEMod:MVlew:RADix(?)

Selects or queries the base of symbols in the main view in the IEEE802.11a/b/g analysis. This command is valid when [:SENSe]:WLAN:MEASurement is set to STABLE (symbol table).

Syntax :DISPlay:WLAN:DDEMod:MVlew:RADix { BINary | OCTal | HEXadecimal }
 :DISPlay:WLAN:DDEMod:MVlew:RADix?

Arguments BINary selects binary notation.
 OCTal selects octal notation.
 HEXadecimal selects hexadecimal notation.

Measurement Modes DEM WLAN

Examples :DISPlay:WLAN:DDEMod:MVlew:RADix BINary
 selects binary notation for the symbol table.

Related Commands :DISPlay:WLAN:DDEMod:SVlew:FORMat

:DISPlay:WLAN:DDEMod:MView:X[:SCALe]:OFFSet(?)

Sets or queries the minimum horizontal value (left edge) in the main view during the IEEE802.11a/b/g analysis.

Syntax :DISPlay:WLAN:DDEMod:MView:X[:SCALe]:OFFSet <value>

:DISPlay:WLAN:DDEMod:MView:X[:SCALe]:OFFSet?

Arguments <value>::=<Nrf> specifies the minimum horizontal value in the main view. Refer to *Note on Horizontal Scaling* on page 2-184 for setting the scale.

Measurement Modes DEMWLAN

Examples :DISPlay:WLAN:DDEMod:MView:X:SCALe:OFFSet -40us
sets the minimum horizontal value to -40 μ s when the main view displays IQ level versus time.

Related Commands [:SENSe]:WLAN:MEASurement

:DISPlay:WLAN:DDEMod:MView:X[:SCALe]:PDIVision(?)

Sets or queries the horizontal scale (time per division) in the time domain display. This command is valid when [:SENSe]:WLAN:MEASurement is set to PVTime, EVTime, EVSC, PVSC, or FERRor (EVSC and PVSC are for non-OFDM display data).

Syntax :DISPlay:WLAN:DDEMod:MView:X[:SCALe]:PDIVision <time>

:DISPlay:WLAN:DDEMod:MView:X[:SCALe]:PDIVision?

Arguments <time>::=<Nrf> specifies the horizontal scale. Range: 0 to 3200 s/div. Refer to *Note on Horizontal Scaling* on page 2-184 for setting the scale.

Measurement Modes DEMWLAN

Examples :DISPlay:WLAN:DDEMod:MView:X:SCALe:PDIVision 10us
sets the horizontal scale to 10 μ s/div.

Related Commands [:SENSe]:WLAN:MEASurement

:DISPlay:WLAN:DDEMod:MVView:X[:SCALE]:RANGe(?)

Sets or queries the full-scale value of the horizontal axis in the main view during the IEEE802.11a/b/g analysis.

Syntax :DISPlay:WLAN:DDEMod:MVView:X[:SCALE]:RANGe <value>

:DISPlay:WLAN:DDEMod:MVView:X[:SCALE]:RANGe?

Arguments <value>: :=<Nrf> specifies the full-scale value of the horizontal axis in the main view. Refer to *Note on Horizontal Scaling* on page 2-184 for setting the scale.

Measurement Modes DEMWLAN

Examples :DISPlay:WLAN:DDEMod:MVView:X:SCALE:RANGe 40us
sets the full-scale value of the horizontal axis to 40 μ s when the main view displays IQ level versus time.

Related Commands [:SENSe]:WLAN:MEASurement

:DISPlay:WLAN:DDEMod:MView:Y[:SCALE]:FIT (No Query Form)

Runs auto-scale on the main view during the IEEE802.11a/b/g analysis. The auto-scale automatically sets the start value and scale of the vertical axis to fit the waveform to the screen.

Syntax :DISPlay:WLAN:DDEMod:MView:Y[:SCALE]:FIT

Arguments None

Measurement Modes DEMWLAN

Examples :DISPlay:WLAN:DDEMod:MView:Y:SCALE:FIT
runs the auto-scale on the main view.

Related Commands [:SENSe]:WLAN:MEASurement

:DISPlay:WLAN:DDEMod:MView:Y[:SCALE]:FULL (No Query Form)

Sets the vertical axis in the main view to the default full-scale value during the IEEE802.11a/b/g analysis.

Syntax :DISPlay:WLAN:DDEMod:MView:Y[:SCALE]:FULL

Arguments None

Measurement Modes DEMWLAN

Examples :DISPlay:WLAN:DDEMod:MView:Y:SCALE:FULL
sets the main view's vertical axis to the default full-scale value.

Related Commands [:SENSe]:WLAN:MEASurement

:DISPlay:WLAN:DDEMod:MVlew:Y[:SCALE]:OFFSet(?)

Sets or queries the minimum vertical value in the main view (bottom) during the IEEE802.11a/b/g analysis.

Syntax :DISPlay:WLAN:DDEMod:MVlew:Y[:SCALE]:OFFSet <value>
 :DISPlay:WLAN:DDEMod:MVlew:Y[:SCALE]:OFFSet?

Arguments <value>::=<Nrf> specifies the minimum vertical value in the main view. The valid range depends on the display format. Refer to Table D-9 in *Appendix D*.

Measurement Modes DEM WLAN

Examples :DISPlay:WLAN:DDEMod:MVlew:Y:SCALE:OFFSet -500mV
 sets the minimum vertical value to -500 mV when the main view displays IQ level versus time.

Related Commands [:SENSe]:WLAN:MEASurement

:DISPlay:WLAN:DDEMod:MVlew:Y[:SCALE]:PDIVision(?)

Sets or queries the vertical scale (per division) in the time domain display. This command is valid when [:SENSe]:WLAN:MEASurement is set to PVTime, EVTime, EVSC, PVSC, or FERRor (EVSC and PVSC are for non-OFDM display data).

Syntax :DISPlay:WLAN:DDEMod:MVlew:Y[:SCALE]:PDIVision <value>
 :DISPlay:WLAN:DDEMod:MVlew:Y[:SCALE]:PDIVision?

Arguments <value>::=<Nrf> specifies the vertical scale. The valid range depends on the display format. Refer to Table D-9 in *Appendix D*.

Measurement Modes DEM WLAN

Examples :DISPlay:WLAN:DDEMod:MVlew:Y:SCALE:PDIVision 10
 sets the vertical scale to 10 dB/div.

Related Commands [:SENSe]:WLAN:MEASurement

:DISPlay:WLAN:DDEMod:MVView:Y[:SCALe]:RANGe(?)

Sets or queries full-scale value of the vertical axis in the main view during the IEEE802.11a/b/g analysis.

Syntax :DISPlay:WLAN:DDEMod:MVView:Y[:SCALe]:RANGe <value>
 :DISPlay:WLAN:DDEMod:MVView:Y[:SCALe]:RANGe?

Arguments <value>: :=<NRf> specifies full-scale value of the vertical axis in the main view. The valid range depends on the display format. Refer to Table D-9 in *Appendix D*.

Measurement Modes DEM WLAN

Examples :DISPlay:WLAN:DDEMod:MVView:Y:SCALe:RANGe 500mV
 sets full-scale value of the vertical axis to 500 mV when the the main view displays IQ level versus time.

Related Commands [:SENSe]:WLAN:MEASurement

:DISPlay:WLAN:DDEMod:SVIew:FORMat(?)

Selects or queries the display format of the subview in the IEEE802.11a/b/g analysis.

Syntax :DISPlay:WLAN:DDEMod:SVIew:FORMat { SPECTrum | PVTime | EVTime
| CONStE | VECTor | PVSC | EVSC | SCConste | SCVector | FERRor
| OFLatness | OLINearity | DOLinearity | STABLE | PON | POFF }

:DISPlay:WLAN:DDEMod:SVIew:FORMat?

Arguments The arguments and display formats are listed below:

Table 2-59: Subview display formats

Argument	Display format
SPECTrum	Spectrum
PVTime	Power versus Time
EVTime	EVM versus Time
CONStE	Constellation
VECTor	Vector
PVSC	Power versus Subcarrier
EVSC	EVM versus Subcarrier
SCConste	Subcarrier Constellation
SCVector	Subcarrier vector
FERRor	Frequency error
OFLatness	OFDM flatness
OLINearity	OFDM linearity (vector display)
DOLinearity	OFDM linearity (dot display)
STABLE	Symbol table
PON ¹	Transmit power on
POFF ¹	Transmit power off

¹ Valid when [:SENSE]:WLAN:MEASurement is set to TPOWER.

Measurement Modes DEMWLAN

Examples :DISPlay:WLAN:DDEMod:SVIew:FORMat CONSTe
displays the constellation in the subview.

Related Commands [:SENSe]:WLAN:MEASurement

:DISPlay:WLAN:DDEMod:SVIew:MCONtent(?)

Selects or queries the measurement content of the subview in the IEEE802.11a/b/g analysis. This command is valid when [:SENSe]:WLAN:MEASurement is set to EVTime or EVSC.

Syntax :DISPlay:WLAN:DDEMod:SVIew:MCONtent { EVM | MERRor | PERRor }
:DISPlay:WLAN:DDEMod:SVIew:MCONtent?

Arguments EVM selects the EVM.
MERRor selects the magnitude (amplitude) error.
PERRor selects the phase error.

Measurement Modes DEM WLAN

Examples :DISPlay:WLAN:DDEMod:SVIew:MCONtent EVM
selects the EVM for the subview content.

Related Commands [:SENSe]:WLAN:MEASurement

:DISPlay:WLAN:DDEMod:SVIew:RADix(?)

Selects or queries the base of symbols in the subview during the IEEE802.11a/b/g analysis.

This command is valid when :DISPlay:WLAN:DDEMod:SVIew:FORMat is set to STABLE (symbol table).

Syntax :DISPlay:WLAN:DDEMod:SVIew:RADix { BINary | OCTal | HEXadecimal }
:DISPlay:WLAN:DDEMod:SVIew:RADix?

Arguments BINary selects binary notation.
OCTal selects octal notation.
HEXadecimal selects hexadecimal notation.

Measurement Modes DEMWLAN

Examples :DISPlay:WLAN:DDEMod:SVIew:RADix BINary
selects binary notation for the symbol table.

Related Commands :DISPlay:WLAN:DDEMod:SVIew:FORMat

:DISPlay:WLAN:DDEMod:SVIew:X[:SCALe]:OFFSet(?)

Sets or queries the minimum horizontal value (left edge) in the subview during the IEEE802.11a/b/g analysis.

Syntax :DISPlay:WLAN:DDEMod:SVIew:X[:SCALe]:OFFSet <value>

:DISPlay:WLAN:DDEMod:SVIew:X[:SCALe]:OFFSet?

Arguments <value>::=<Nrf> specifies the minimum horizontal value in the subview. Refer to *Note on Horizontal Scaling* on page 2-184 for setting the scale.

Measurement Modes DEMWLAN

Examples :DISPlay:WLAN:DDEMod:SVIew:X:SCALe:OFFSet -2.5
sets the minimum horizontal value to -2.5 when the subview displays the constellation.

Related Commands :DISPlay:WLAN:DDEMod:SVIew:FORMat

:DISPlay:WLAN:DDEMod:SVIew:X[:SCALe]:PDIVision(?)

Sets or queries the horizontal scale (time per division) for the time domain display in the subview. This command is valid when [SENSE]:WLAN:MEASurement is set to PVTime, EVTime, EVSC, PVSC, or FERRor (EVSC and PVSC are for non-OFDM display data).

Syntax :DISPlay:WLAN:DDEMod:SVIew:X[:SCALe]:PDIVision <time>

:DISPlay:WLAN:DDEMod:SVIew:X[:SCALe]:PDIVision?

Arguments <time>::=<Nrf> specifies the horizontal scale. Refer to *Note on Horizontal Scaling* on page 2-184 for setting the scale.

Measurement Modes DEMWLAN

Examples :DISPlay:WLAN:DDEMod:SVIew:X:SCALe:PDIVision 10us
sets the horizontal scale to 10 μ s/div.

Related Commands :DISPlay:WLAN:DDEMod:SVIew:FORMat, [SENSE]:WLAN:MEASurement

:DISPlay:WLAN:DDEMod:SVIew:X[:SCALe]:RANGe(?)

Sets or queries full-scale value of the horizontal axis in the subview during the IEEE802.11a/b/g analysis.

Syntax :DISPlay:WLAN:DDEMod:SVIew:X[:SCALe]:RANGe <value>

:DISPlay:WLAN:DDEMod:SVIew:X[:SCALe]:RANGe?

Arguments <value>: :=<NRf> specifies full-scale value of the horizontal axis in the subview. Refer to *Note on Horizontal Scaling* on page 2-184 for setting the scale.

Measurement Modes DEMWLAN

Examples :DISPlay:WLAN:DDEMod:SVIew:X:SCALe:RANGe 2.5
sets full-scale value of the horizontal axis to 2.5 when the subview displays the constellation.

Related Commands :DISPlay:WLAN:DDEMod:SVIew:FORMat

:DISPlay:WLAN:DDEMod:SVIew:Y[:SCALE]:FIT (No Query Form)

Runs auto-scale on the subview during the IEEE802.11a/b/g analysis. The auto-scale automatically sets the start value and scale of the vertical axis to fit the waveform to the screen.

Syntax :DISPlay:WLAN:DDEMod:SVIew:Y[:SCALE]:FIT

Arguments None

Measurement Modes DEMWLAN

Examples :DISPlay:WLAN:DDEMod:SVIew:Y:SCALE:FIT
runs the auto-scale on the subview.

Related Commands :DISPlay:WLAN:DDEMod:SVIew:FORMat

:DISPlay:WLAN:DDEMod:SVIew:Y[:SCALE]:FULL (No Query Form)

Sets the vertical axis in the subview to the default full-scale value during the IEEE802.11a/b/g analysis.

Syntax :DISPlay:WLAN:DDEMod:SVIew:Y[:SCALE]:FULL

Arguments None

Measurement Modes DEMWLAN

Examples :DISPlay:WLAN:DDEMod:SVIew:Y:SCALE:FULL
sets the vertical axis in the subview to the default full-scale value.

Related Commands :DISPlay:WLAN:DDEMod:SVIew:FORMat

:DISPlay:WLAN:DDEMod:SVIew:Y[:SCALe]:OFFSet(?)

Sets or queries the minimum vertical value (bottom) in the subview during the IEEE802.11a/b/g analysis.

Syntax :DISPlay:WLAN:DDEMod:SVIew:Y[:SCALe]:OFFSet <value>

:DISPlay:WLAN:DDEMod:SVIew:Y[:SCALe]:OFFSet?

Arguments <value>::=<Nrf> specifies the minimum vertical value in the subview. The valid range depends on the display format. Refer to Table D-9 in *Appendix D*.

Measurement Modes DEMWLAN

Examples :DISPlay:WLAN:DDEMod:SVIew:Y:SCALe:OFFSet -100
sets the minimum vertical value to -100 dBm when the subview displays spectrum.

Related Commands :DISPlay:WLAN:DDEMod:SVIew:FORMat

:DISPlay:WLAN:DDEMod:SVIew:Y[:SCALe]:PDIVision(?)

Sets or queries the vertical scale (per division) for the time domain display in the subview. This command is valid when [:SENSe]:WLAN:MEASurement is set to PVTime, EVTime, EVSC, PVSC, or FERRor (EVSC and PVSC are for non-OFDM display data).

Syntax :DISPlay:WLAN:DDEMod:SVIew:Y[:SCALe]:PDIVision <value>

:DISPlay:WLAN:DDEMod:SVIew:Y[:SCALe]:PDIVision?

Arguments <value>::=<Nrf> specifies the vertical scale. The valid range depends on the display format. Refer to Table D-9 in *Appendix D*.

Measurement Modes DEMWLAN

Examples :DISPlay:WLAN:DDEMod:SVIew:Y:SCALe:PDIVision 10
sets the vertical scale to 10 dB/div.

Related Commands :DISPlay:WLAN:DDEMod:SVIew:FORMat, [:SENSe]:WLAN:MEASurement

:DISPlay:WLAN:DDEMod:SVIew:Y[:SCALe]:RANGe(?)

Sets or queries full-scale value of the vertical axis in the subview during the IEEE802.11a/b/g analysis.

Syntax :DISPlay:WLAN:DDEMod:SVIew:Y[:SCALe]:RANGe <value>

:DISPlay:WLAN:DDEMod:SVIew:Y[:SCALe]:RANGe?

Arguments <value>: :=<NRf> specifies full-scale value of the vertical axis in the subview. The valid range depends on the display format. Refer to Table D-9 in *Appendix D*.

Measurement Modes DEMWLAN

Examples :DISPlay:WLAN:DDEMod:SVIew:Y:SCALe:RANGe 100
sets full-scale value of the vertical axis to 100 dB when the subview displays spectrum.

Related Commands :DISPlay:WLAN:DDEMod:SVIew:FORMat

:DISPlay:WLAN:SPECTrum Subgroup**WLAN, Option 29 Only**

The :DISPlay:WLAN:SPECTrum commands control display for the spectrum mask and transmit power measurements in the IEEE802.11n a/b/g analysis.

NOTE. To use a command from this group, you must have selected DEMWLAN (WLAN analysis) in the :INSTrument[:SElect] command.

Command Tree	Header	Parameter
	:DISPlay	
	:WLAN	
	:SPECTrum	
	:X	
	[:SCALE]	
	:OFFSet	<frequency>
	:PDIVision	<frequency>
	:Y	
	[:SCALE]	
	:FIT	
	:FULL	
	:OFFSet	<amplitude>
	:PDIVision	<amplitude>

:DISPlay:WLAN:SPECTrum:X[:SCALe]:OFFSet(?)

Sets or queries the minimum horizontal, or frequency, value (left edge) in the spectrum view.

Syntax :DISPlay:WLAN:SPECTrum:X[:SCALe]:OFFSet <freq>

 :DISPlay:WLAN:SPECTrum:X[:SCALe]:OFFSet?

Arguments <freq>::=<Nrf> specifies the minimum horizontal value in the spectrum view. Refer to *Note on Horizontal Scaling* on page 2-184 for setting the scale.

Measurement Modes DEM WLAN

Examples :DISPlay:WLAN:SPECTrum:X:SCALe:OFFSet 100MHz
 sets the minimum horizontal value to 100 MHz.

:DISPlay:WLAN:SPECTrum:X[:SCALe]:PDIVision(?)

Sets or queries the horizontal, or frequency, scale (per division) in the spectrum view.

Syntax :DISPlay:WLAN:SPECTrum:X[:SCALe]:PDIVision <freq>

 :DISPlay:WLAN:SPECTrum:X[:SCALe]:PDIVision?

Arguments <freq>::=<Nrf> specifies the horizontal scale (per division). Refer to *Note on Horizontal Scaling* on page 2-184 for setting the scale.

Measurement Modes DEM WLAN

Examples :DISPlay:WLAN:SPECTrum:X:SCALe:PDIVision 100.0E+3
 sets the horizontal scale to 100 kHz/div.

:DISPlay:WLAN:SPECTrum:Y[:SCALe]:FIT (No Query Form)

Runs auto-scale on the spectrum view.

The auto-scale automatically sets the start value and scale of the vertical axis to fit the waveform to the screen.

Syntax :DISPlay:WLAN:SPECTrum:Y[:SCALe]:FIT

Arguments None

Measurement Modes DEMWLAN

Examples :DISPlay:WLAN:SPECTrum:Y:SCALe:FIT
runs the auto-scale on the spectrum view.

:DISPlay:WLAN:SPECTrum:Y[:SCALe]:FULL (No Query Form)

Sets the vertical axis to the default full-scale value in the spectrum view.

Syntax :DISPlay:WLAN:SPECTrum:Y[:SCALe]:FULL

Arguments None

Measurement Modes DEMWLAN

Examples :DISPlay:WLAN:SPECTrum:Y:SCALe:FULL
sets the vertical axis to the default full-scale value in the spectrum view.

:DISPlay:WLAN:SPECTrum:Y[:SCALe]:OFFSet(?)

Sets or queries the minimum vertical, or amplitude, value (bottom) in the spectrum view.

Syntax :DISPlay:WLAN:SPECTrum:Y[:SCALe]:OFFSet <amp1>

 :DISPlay:WLAN:SPECTrum:Y[:SCALe]:OFFSet?

Arguments <amp1>::=<NRf> sets the minimum vertical value. Range: -200 to 0 dBm.

Measurement Modes DEM WLAN

Examples :DISPlay:WLAN:SPECTrum:Y:SCALe:OFFSet -100
 sets the minimum vertical value to -100 dBm.

:DISPlay:WLAN:SPECTrum:Y[:SCALe]:PDIVision(?)

Sets or queries the vertical, or amplitude, scale (per division) in the spectrum view.

Syntax :DISPlay:WLAN:SPECTrum:Y[:SCALe]:PDIVision <amp1>

 :DISPlay:WLAN:SPECTrum:Y[:SCALe]:PDIVision?

Arguments <amp1>::=<NRf> specifies the vertical scale in the spectrum view.
 Range: 0 to 10 dB/div.

Measurement Modes DEM WLAN

Examples :DISPlay:WLAN:SPECTrum:Y:SCALe:PDIVision 10
 sets the vertical scale to 10 dB/div.

:DISPlay:DLR6_3GPP Subgroup**3GPP-R6, Option 40 Only**

The :DISPlay:DLR6_3GPP commands control display of the modulation analysis for 3GPP-R6 downlink.

NOTE. To use a command from this group, you must have selected *DEMDLR6_3G* (modulation analysis for 3GPP-R6 downlink) in the *:INSTrument[:SElect]* command.

Command Tree	Header	Parameter
	:DISPlay	
	:DLR6_3GPP	
	:AVIEW	
	:CCODE	<number>
	:MSLOT	
	:HEAD	<numeric_value>
	[:STATE]	<boolean>
	:RESult	
	:AGSCOPE	<boolean>
	:AGVAlue	<boolean>
	:ANACK	<boolean>
	:RGRant	<boolean>
	:SSCH	<boolean>
	:SCGRoup	<boolean>
	:SCNumber	<boolean>
	:SRATE	COMPOSITE R960S R480S R240S R120S R60S R30S R15S R7P5S
	:SSCHpart	<boolean>
	:TSLot	<number>
	:MPIEW :SVIEW	
	:COLor	
	[:SCALE]	
	:OFFSet	<amplitude>
	:RANge	<relative_amplitude>
	:ELENgth	<numeric_value>
	:FORMat	OFF CSGRam CPCCode CPSYmbol CPTSlot SCONste SVEctor SEVM SMError SPError SIEYe SQEYe STEYe STABLE CONSte VECtor MREVM MPEVM MRMError MPMError MRPError MPPError MPCDe MAPCde MFERror MOOFfset SPECTrum

```
:POWer
  [:TOTal] <boolean>
  :SElect CODE | PSCH | SSCH
:RADix BINary | OCTal | HEXadecimal
:ROtation <numeric_value>
:X
  [:SCALE]
  :OFFSet <numeric_value>
  :RANGe <numeric_value>
:Y
  [:SCALE]
  :FIT
  :FULL
  :OFFSet <numeric_value>
  :PUNit RELative | ABSolute
  :RANGe <numeric_value>
```

:DISPlay:DLR6_3GPP:AVIew:CCODE(?)

Sets or queries the channelization code to position the marker in the 3GPP-R6 downlink modulation analysis.

Syntax :DISPlay:DLR6_3GPP:AVIew:CCODE <number>
:DISPlay:DLR6_3GPP:AVIew:CCODE?

Arguments <number>::=<NR1> specifies the channelization code.
Range: Channel 0 to 511.

Measurement Modes DEMDLR6_3G

Examples :DISPlay:DLR6_3GPP:AVIew:CCODE 100
sets the channelization code to 100 to position the marker.

:DISPlay:DLR6_3GPP:AVIew:MSLot:HEAD(?)

Sets or queries the index of the time slot to be displayed at the left edge on the view when :DISPlay:DLR6_3GPP:AVIew:MSLot[:STATe] is On. This function is not supported by local operation.

Syntax :DISPlay:DLR6_3GPP:AVIew:MSLot:HEAD <number>
:DISPlay:DLR6_3GPP:AVIew:MSLot:HEAD?

Arguments <number>::=<NR1> specifies the index of the time slot to be displayed at the left edge on the view. Range: -15985 to -14.

When the number of analyzed time slots is 15 or less, this command has no effect on the analyzer setting and the query returns the value of -[(the number of analyzed time slots) - 1].

Measurement Modes DEMDLR6_3G

Examples :DISPlay:DLR6_3GPP:AVIew:MSLot:HEAD -100
sets the number of the head of the time slot to -100.

Related Commands :DISPlay:DLR6_3GPP:AVIew:MSLot[:STATe]

:DISPlay:DLR6_3GPP:AVIew:MSLot[:STATe](?)

Determines whether to display the multiple or the single slot.

The multiple slot is valid when :DISPlay:DLR6_3GPP:MVIew:FORMat is set to CPSSymbol, CPRSlot, SEVM, SMERror, SPERror, or CSGRam

Syntax :DISPlay:DLR6_3GPP:AVIew:MSLot[:STATe] { OFF | ON | 0 | 1 }
:DISPlay:DLR6_3GPP:AVIew:MSLot[:STATe]?

Arguments OFF or 0 displays the single slot.
ON or 1 displays the multiple slot. You can specify the index of the time slot to be displayed at the left edge on the view with the :DISPlay:DLR6_3GPP:AVIew:MSLot:HEAD command.

Measurement Modes DEMDLR6_3G

Examples :DISPlay:DLR6_3GPP:AVIew:MSLot:STATe ON
displays the multiple slot.

Related Commands :DISPlay:DLR6_3GPP:AVIew:MSLot:HEAD
:DISPlay:DLR6_3GPP:MVIew:FORMat

:DISPlay:DLR6_3GPP:AVIew:RESult:AGSCope(?)

Determines whether to show or hide Absolute Grant Scope (E-AGCH) in the time-slot table.

Syntax :DISPlay:DLR6_3GPP:AVIew:RESult:AGSCope { OFF | ON | 0 | 1 }
:DISPlay:DLR6_3GPP:AVIew:RESult:AGSCope?

Arguments OFF or 0 hides Absolute Grant Scope in the time-slot table.
ON or 1 shows Absolute Grant Scope in the time-slot table.

Measurement Modes DEMDLR6_3G

Examples :DISPlay:DLR6_3GPP:AVIew:RESult:AGSCope ON
shows Absolute Grant Scope in the time-slot table.

:DISPlay:DLR6_3GPP:AVIew:RESult:AGValue(?)

Determines whether to show or hide Absolute Grant Value (E-AGCH) in the time-slot table.

Syntax :DISPlay:DLR6_3GPP:AVIew:RESult:AGValue { OFF | ON | 0 | 1 }
:DISPlay:DLR6_3GPP:AVIew:RESult:AGValue?

Arguments OFF or 0 hides Absolute Grant Value in the time-slot table.
ON or 1 shows Absolute Grant Value in the time-slot table.

Measurement Modes DEMDLR6_3G

Examples :DISPlay:DLR6_3GPP:AVIew:RESult:AGValue ON
shows Absolute Grant Value in the time-slot table.

:DISPlay:DLR6_3GPP:AVIew:RESult:ANACK(?)

Determines whether to show or hide Ack/Nack (E-HICH) in the time-slot table.

Syntax :DISPlay:DLR6_3GPP:AVIew:RESult:ANACK { OFF | ON | 0 | 1 }
:DISPlay:DLR6_3GPP:AVIew:RESult:ANACK?

Arguments OFF or 0 hides Ack/Nack (E-HICH) in the time-slot table.
ON or 1 shows Ack/Nack (E-HICH) in the time-slot table.

Measurement Modes DEMDLR6_3G

Examples :DISPlay:DLR6_3GPP:AVIew:RESult:ANACK ON
shows Ack/Nack (E-HICH) in the time-slot table.

:DISPlay:DLR6_3GPP:AVIew:RESult:RGRant(?)

Determines whether to show or hide Relative Grant Value (E-RGCH) in the time-slot table.

Syntax :DISPlay:DLR6_3GPP:AVIew:RESult:RGRant { OFF | ON | 0 | 1 }
:DISPlay:DLR6_3GPP:AVIew:RESult:RGRant?

Arguments OFF or 0 hides Relative Grant Value in the time-slot table.
ON or 1 shows Relative Grant Value in the time-slot table.

Measurement Modes DEMDLR6_3G

Examples :DISPlay:DLR6_3GPP:AVIew:RESult:RGRant ON
shows Relative Grant Value in the time-slot table.

:DISPlay:DLR6_3GPP:AVIew:RESult:SCGRoup(?)

Determines whether to show or hide SCG (Scrambling Code Group) in the time-slot table.

Syntax :DISPlay:DLR6_3GPP:AVIew:RESult:SCGRoup { OFF | ON | 0 | 1 }
:DISPlay:DLR6_3GPP:AVIew:RESult:SCGRoup?

Arguments OFF or 0 hides SCG in the time-slot table.
ON or 1 shows SCG in the time-slot table.

Measurement Modes DEMDLR6_3G

Examples :DISPlay:DLR6_3GPP:AVIew:RESult:SCGRoup ON
shows SCG in the time-slot table.

:DISPlay:DLR6_3GPP:AVIew:RESult:SCNumber(?)

Determines whether to show or hide SCN (Scrambling Code Number) in the time-slot table.

Syntax :DISPlay:DLR6_3GPP:AVIew:RESult:SCNumber { OFF | ON | 0 | 1 }
:DISPlay:DLR6_3GPP:AVIew:RESult:SCNumber?

Arguments OFF or 0 hides SCN in the time-slot table.
ON or 1 shows SCN in the time-slot table.

Measurement Modes DEMDLR6_3G

Examples :DISPlay:DLR6_3GPP:AVIew:RESult:SCNumber ON
shows SCN in the time-slot table.

:DISPlay:DLR6_3GPP:AVIew:RESuLt:SSCH(?)

Determines whether to show or hide S-SCH (Secondary Synchronization Channel) in the time-slot table.

Syntax :DISPlay:DLR6_3GPP:AVIew:RESuLt:SSCH { OFF | ON | 0 | 1 }
 :DISPlay:DLR6_3GPP:AVIew:RESuLt:SSCH?

Arguments OFF or 0 hides S-SCH in the time-slot table.
 ON or 1 shows S-SCH in the time-slot table.

Measurement Modes DEMDLR6_3G

Examples :DISPlay:DLR6_3GPP:AVIew:RESuLt:SSCH ON
 shows S-SCH in the time-slot table.

:DISPlay:DLR6_3GPP:AVIew:SRATe(?)

Sets or queries the symbol rate for the measurement in the 3GPP-R6 downlink modulation analysis.

Syntax :DISPlay:DLR6_3GPP:AVIew:SRATe { COMPOSITE | R960S | R480S
| R240S | R120S | R60S | R30S | R15S | R7P5S }
:DISPlay:DLR6_3GPP:AVIew:SRATe?

Arguments The arguments specify the symbol rates as listed below:

Table 2-60: Symbol rate settings

Argument	Symbol rate
COMPOSITE (default)	Corresponds to multi-rate
R960S	960 k
R480S	480 k
R240S	240 k
R120S	120 k
R60S	60 k
R30S	30 k
R15S	15 k
R7P5S	7.5 k

NOTE. If a normal analysis does not result, select OFF in the [:SENSE] :DLR6_3GPP:COMPOSITE command and then select one of the symbol rates (other than COMPOSITE) listed in Table 3-10.

Measurement Modes DEMDLR6_3G

Examples :DISPlay:DLR6_3GPP:AVIew:SRATe R960S
sets the symbol rate to 960 k.

Related Commands [:SENSE]:DLR6_3GPP:COMPOSITE

:DISPlay:DLR6_3GPP:AVIew:SSCHpart(?)

Determines whether to show SCH at the head of data in the 3GPP-R6 modulation analysis.

Syntax :DISPlay:DLR6_3GPP:AVIew:SSCHpart { OFF | ON | 0 | 1 }
 :DISPlay:DLR6_3GPP:AVIew:SSCHpart?

Arguments OFF or 0 hides SCH.
 ON or 1 shows SCH.

Measurement Modes DEMDLR6_3G

Examples :DISPlay:DLR6_3GPP:AVIew:SSCHpart ON
 shows SCH.

:DISPlay:DLR6_3GPP:AVIew:TSLot(?)

Sets or queries the number of the time slot to be displayed in the 3GPP-R6 modulation analysis.

Syntax :DISPlay:DLR6_3GPP:AVIew:TSLot <number>
 :DISPlay:DLR6_3GPP:AVIew:TSLot?

Arguments <number>::=<NR1> specifies the number of the time slot to be displayed. Range: Slot -15999 to 0.

Measurement Modes DEMDLR6_3G

Examples :DISPlay:DLR6_3GPP:AVIew:TSLot -100
 sets the time slot number to -100.

:DISPlay:DLR6_3GPP:MView|:SVIew:COLor[:SCALe]:OFFSet(?)

Sets or queries the minimum value on the color, or amplitude, axis when the view displays a spectrogram in the 3GPP-R6 modulation analysis.

Syntax :DISPlay:DLR6_3GPP:MView|:SVIew:COLor[:SCALe]:OFFSet <value>
:DISPlay:DLR6_3GPP:MView|:SVIew:COLor[:SCALe]:OFFSet?

Arguments <value>::=<NRf> specifies the minimum value on the color axis.
Range: -100 to 0 dBm.

Measurement Modes DEMDLR6_3G

Examples :DISPlay:DLR6_3GPP:MView:COLor:SCALe:OFFSet -100
sets the minimum value on the color axis in the main view to -100 dBm.

Related Commands :DISPlay:DLR6_3GPP:MView|:SVIew:FORMat

:DISPlay:DLR6_3GPP:MView|:SVIew:COLor[:SCALe]:RANGe(?)

Sets or queries full-scale value of the color, or amplitude, axis when the view displays a spectrogram in the 3GPP-R6 modulation analysis.

Syntax :DISPlay:DLR6_3GPP:MView|:SVIew:COLor[:SCALe]:RANGe <value>
:DISPlay:DLR6_3GPP:MView|:SVIew:COLor[:SCALe]:RANGe?

Arguments <value>::={ 5 | 10 | 20 | 50 } [dB] specifies full-scale value of the color axis in the spectrogram view.

Measurement Modes DEMDLR6_3G

Examples :DISPlay:DLR6_3GPP:MView:COLor:SCALe:RANGe 50
sets full-scale value of the color axis to 50 dB.

Related Commands :DISPlay:DLR6_3GPP:MView|:SVIew:FORMat

:DISPlay:DLR6_3GPP:MView|:SView:ELENgth(?)

Selects or queries the eye length of the eye diagram in the main view or subview during the 3GPP-R6 modulation analysis. This command is valid when :DISPlay:DLR6_3GPP:MView|:SView:FORMat is set to SIEYe, SQEYe, or STEYe.

Syntax :DISPlay:DLR6_3GPP:MView|:SView:ELENgth <value>
 :DISPlay:DLR6_3GPP:MView|:SView:ELENgth?

Arguments <value>::=<NR1> specifies the eye length of the eye diagram.
 Range: 1 to 16.

Measurement Modes DEM DLR6_3G

Examples :DISPlay:DLR6_3GPP:MView:ELENgth 8
 sets the eye length to 8 in the main view.

Related Commands :DISPlay:DLR6_3GPP:MView|:SView:FORMat

:DISPlay:DLR6_3GPP:MView|:SVIew:FORMat(?)

Selects or queries the main view or subview display format in the 3GPP-R6 downlink analysis.

Syntax :DISPlay:DLR6_3GPP:MView|:SVIew:FORMat { OFF | CSGRam
| CPCCode | CPSYmbol | CPTSlot | SCONste | SVEctor
| SEVM | SMERror | SPERror | SIEYe | SQEYe | STEYe
| STABLE | CONSte | VECTor | MREVm | MPEVm | MRMerror | MPMerror
| MRPeror | MPPerror | MPCDe | MAPCde | MFERror | MOOFset
| SPECTrum }

:DISPlay:DLR6_3GPP:MView|:SVIew:FORMat?

Arguments Table 2-54 shows the arguments and display formats.

Table 2-61: 3GPP-R6 downlink modulation analysis display formats

Argument	Format
OFF	Hides all measurement results (main view only)
CSGRam	Code domain power spectrogram
CPCCode	Code domain power versus Channelization code
CPSYmbol	Code domain power versus Symbol
CPTSlot	Code domain power versus Time slot
SCONste	Symbol constellation
SVEctor	Symbol vector
SEVM	Symbol EVM
SMERror	Symbol amplitude error
SPERror	Symbol phase error
SIEYe	Symbol eye diagram (vertical axis: I)
SQEYe	Symbol eye diagram (vertical axis: Q)
STEYe	Symbol trellis diagram (vertical axis: Phase)
STABLE	Symbol table
CONSte	Constellation and modulation accuracy measurement results
VECTor	Vector locus
MREVm	Modulation accuracy versus Time slot: EVM (rms)
MPEVm	Modulation accuracy versus Time slot: EVM (peak)
MRMerror	Modulation accuracy versus Time slot: Amplitude error (rms)
MPMerror	Modulation accuracy versus Time slot: Amplitude error (peak)

Table 2-61: 3GPP-R6 downlink modulation analysis display formats (Cont.)

Argument	Format
MRPerror	Modulation accuracy versus Time slot: Phase error (rms)
MPPerror	Modulation accuracy versus Time slot: Phase error (peak)
MPCDe	Modulation accuracy versus Time slot: PCDE
MAPCde	Modulation accuracy versus Time slot: PCDE (active)
MFError	Modulation accuracy versus Time slot: Frequency error
MOOffset	Modulation accuracy versus Time slot: Origin offset
SPECTrum	Spectrum (subview only)

Measurement Modes DEMDLR6_3G

Examples :DISPlay:DLR6_3GPP:MVIew:FORMat CSGRam
displays the code domain power spectrogram in the main view.

:DISPlay:DLR6_3GPP:MVIew|:SVIew:POWer[:TOTal](?)

Determines whether to display the total power for each time slot in the Code power versus Time slot view. This command is valid when :DISPlay :DLR6_3GPP:MVIew|:SVIew:FORMat is set to CPTSlot (Code power versus Time slot).

Syntax :DISPlay:DLR6_3GPP:MVIew|:SVIew:POWer[:TOTal]
{ ON | OFF | 1 | 0 }
:DISPlay:DLR6_3GPP:MVIew|:SVIew:POWer[:TOTal]?

Arguments OFF or 0 displays power of the channel specified with the :DISPlay :DLR6_3GPP:AVIew:CNUMBER command.
ON or 1 displays the total power of all channels for each time slot.

Measurement Modes DEMDLR6_3G

Examples :DISPlay:DLR6_3GPP:MVIew:POWer:TOTal ON
displays the total power of all channels for each time slot in the main view.

Related Commands :DISPlay:DLR6_3GPP:MVIew|:SVIew:FORMat

:DISPlay:DLR6_3GPP:MView|:SVIew:POWer:SElect(?)

Selects or queries the channel to show the power for each time slot.in the Code power versus Time slot view. This command is valid when :DISPlay:DLR6_3GPP:MView|:SVIew:FORMat is set to CPTSlot (Code power versus Time slot).

Syntax :DISPlay:DLR6_3GPP:MView|:SVIew:POWer:SElect
 { CODE | PSCH | SSCH }

 :DISPlay:DLR6_3GPP:MView|:SVIew:POWer:SElect?

Arguments CODE shows the power of all channels or the specified channel, depending on the setting of the :DISPlay:DLR6_3GPP:MView|:SVIew:POWer[:TOTal] command.

 PSCH shows the power of the P-SCH (Primary Synchronization Channel).

 SSCH shows the power of the S-SCH (Secondary Synchronization Channel).

Measurement Modes DEMDLR6_3G

Examples :DISPlay:DLR6_3GPP:MView:POWer:SElect SSCH
 shows the power of the S-SCH in the main view.

Related Commands :DISPlay:DLR6_3GPP:MView|:SVIew:FORMat,
 :DISPlay:DLR6_3GPP:MView|:SVIew:POWer[:TOTal]

:DISPlay:DLR6_3GPP:MView|:SVIew:RADix(?)

Selects or queries the base of symbols on the main view or subview in the 3GPP-R6 modulation analysis.

This command is valid when :DISPlay:DLR6_3GPP:MView|:SVIew:FORMat is STABLE (symbol table).

Syntax :DISPlay:DLR6_3GPP:MView|:SVIew:RADix
 { BINary | OCTal | HEXadecimal }

 :DISPlay:DLR6_3GPP:MView|:SVIew:RADix?

Arguments BINary selects binary notation.

 OCTal selects octal notation.

 HEXadecimal selects hexadecimal notation.

Measurement Modes DEMDLR6_3G

Examples :DISPlay:DLR6_3GPP:MView:RADix BINary
 selects binary notation for the base of symbols in the main view.

Related Commands :DISPlay:DLR6_3GPP:MView|:SVIew:FORMat

:DISPlay:DLR6_3GPP:MView|:SVIew:ROTation(?)

Selects or queries the rotation of the symbol table in the main view or subview during the 3GPP-R6 modulation analysis. This command is valid when :DISPlay:DLR6_3GPP:MView|:SVIew:FORMat is set to STABLE (symbol table).

Syntax :DISPlay:DLR6_3GPP:MView|:SVIew:ROTation <value>
:DISPlay:DLR6_3GPP:MView|:SVIew:ROTation?

Arguments <value>::=<NR1> specifies the rotation of the symbol table.
Range: 0 to 3.

Measurement Modes DEMDLR6_3G

Examples :DISPlay:DLR6_3GPP:MView:ROTation 1
sets the rotation to 1 in the main view.

Related Commands :DISPlay:DLR6_3GPP:MView|:SVIew:FORMat

:DISPlay:DLR6_3GPP:MView|:SVIew:X[:SCALe]:OFFSet(?)

Sets or queries the minimum horizontal value (left edge) on the main view or subview in the 3GPP-R6 modulation analysis.

Syntax :DISPlay:DLR6_3GPP:MView|:SVIew:X[:SCALe]:OFFSet <value>

 :DISPlay:DLR6_3GPP:MView|:SVIew:X[:SCALe]:OFFSet?

Arguments <value>::=<NRf> specifies the minimum horizontal value.
Refer to *Note on Horizontal Scaling* on page 2-184 for setting the scale.

Measurement Modes DEMDLR6_3G

Examples :DISPlay:DLR6_3GPP:MView:X:SCALe:OFFSet 0
sets the minimum horizontal value to channel 0 when the main view displays a code domain power spectrogram.

Related Commands :DISPlay:DLR6_3GPP:MView|:SVIew:FORMat

:DISPlay:DLR6_3GPP:MView|:SVIew:X[:SCALe]:RANGe(?)

Sets or queries full-scale value of the horizontal axis in the main view or subview in the 3GPP-R6 modulation analysis.

Syntax :DISPlay:DLR6_3GPP:MView|:SVIew:X[:SCALe]:RANGe <value>

 :DISPlay:DLR6_3GPP:MView|:SVIew:X[:SCALe]:RANGe?

Arguments <value>::=<NRf> specifies full-scale value of the horizontal axis.
Refer to *Note on Horizontal Scaling* on page 2-184 for setting the scale.

Measurement Modes DEMDLR6_3G

Examples :DISPlay:DLR6_3GPP:MView:X:SCALe:RANGe 512
sets the horizontal full-scale value to 512 channels when the main view displays a code domain power spectrogram.

Related Commands :DISPlay:DLR6_3GPP:MView|:SVIew:FORMat

:DISPlay:DLR6_3GPP:MView|:SVIew:Y[:SCALE]:FIT (No Query Form)

Runs auto-scale on the main view or subview in the 3GPP-R6 modulation analysis. The auto-scale automatically sets the start value and scale of the vertical axis to best display the waveform.

This command is valid when :DISPlay:DLR6_3GPP:MView|:SVIew:FORMat is CPCCode, CPSYmbol, CPTSlot, SEVM, SMERror, or SPERror.

Syntax :DISPlay:DLR6_3GPP:MView|:SVIew:Y[:SCALE]:FIT

Arguments None

Measurement Modes DEMDLR6_3G

Examples :DISPlay:DLR6_3GPP:MView|:SVIew:Y:SCALE:FIT
runs the auto-scale on the main view.

Related Commands :DISPlay:DLR6_3GPP:MView|:SVIew:FORMat

:DISPlay:DLR6_3GPP:MView|:SVIew:Y[:SCALE]:FULL (No Query Form)

Sets the main view or subview's vertical axis to the default full-scale value in the 3GPP-R6 modulation analysis.

This command is valid when :DISPlay:DLR6_3GPP:MView|:SVIew:FORMat is CPCCode, CPSYmbol, CPTSlot, SEVM, SMERror, or SPERror.

Syntax :DISPlay:DLR6_3GPP:MView|:SVIew:Y[:SCALE]:FULL

Arguments None

Measurement Modes DEMDLR6_3G

Examples :DISPlay:DLR6_3GPP:MView:Y:SCALE:FULL
sets the main view's vertical axis to the default full-scale value.

Related Commands :DISPlay:DLR6_3GPP:MView|:SVIew:FORMat

:DISPlay:DLR6_3GPP:MView|:SVIew:Y[:SCALe]:OFFSet(?)

Sets or queries the minimum vertical value (bottom) in the main view or subview in the 3GPP-R6 modulation analysis.

This command is valid when :DISPlay:DLR6_3GPP:MView|:SVIew:FORMat is set to CSGRam, CPCCode, CPSYmbol, CPTSlot, SEVM, SMERror, or SPERror.

Syntax :DISPlay:DLR6_3GPP:MView|:SVIew:Y[:SCALe]:OFFSet <value>

:DISPlay:DLR6_3GPP:MView|:SVIew:Y[:SCALe]:OFFSet?

Arguments <value>::=<NRf> specifies the minimum vertical value in the main view. The valid range depends on the display format. Refer to Table D-5 in *Appendix D*.

Measurement Modes DEMDLR6_3G

Examples :DISPlay:DLR6_3GPP:MView:Y:SCALe:OFFSet 0
sets the bottom of the vertical axis to channel 0 when the main view displays a code domain power spectrogram.

Related Commands :DISPlay:DLR6_3GPP:MView|:SVIew:FORMat

:DISPlay:DLR6_3GPP:MView|:SVIew:Y[:SCALe]:PUNit(?)

Selects or queries the unit on the Y (color) axis in the main view or subview during the 3GPP-R6 modulation analysis.

This command is valid when :DISPlay:DLR6_3GPP:MView|:SVIew:FORMat is set to CSGRam, CPCCode, CPSYmbol, or CPTSlot.

Syntax :DISPlay:DLR6_3GPP:MView|:SVIew:Y[:SCALe]:PUNit { RELative | ABSolute }

:DISPlay:DLR6_3GPP:MView|:SVIew:Y[:SCALe]:PUNit?

Arguments RELative represents the relative channel power to the total power of all the channels along the Y axis in dB.

ABSolute represents the absolute power of each channel along the Y axis in dBm.

Measurement Modes DEMDLR6_3G

Examples :DISPlay:DLR6_3GPP:MView|:SVIew:Y:SCALe:PUNit RELative
represents the relative power along the Y axis in the main view.

Related Commands :DISPlay:DLR6_3GPP:MView|:SVIew:FORMat

:DISPlay:DLR6_3GPP:MView|:SVIew:Y[:SCALe]:RANGe(?)

Sets or queries full-scale value of the vertical axis in the main view or subview in the 3GPP-R6 modulation analysis.

This command is valid when :DISPlay:DLR6_3GPP:MView|:SVIew:FORMat is set to CSGRam, CPCCode, CPSYmbol, CPTSlot, SEVM, SMERror, or SPERror.

Syntax :DISPlay:DLR6_3GPP:MView|:SVIew:Y[:SCALe]:RANGe <value>

:DISPlay:DLR6_3GPP:MView|:SVIew:Y[:SCALe]:RANGe?

Arguments <value>: :=<NRf> specifies full-scale value of the vertical axis. The valid range depends on the display format. Refer to Table D-5 in *Appendix D*.

Measurement Modes DEMDLR6_3G

Examples :DISPlay:DLR6_3GPP:MView:Y:SCALe:RANGe 50
sets the vertical full-scale value to 50 slots when the main view displays a power codogram.

Related Commands :DISPlay:DLR6_3GPP:MView|:SVIew:FORMat

:DISPlay:ULR6_3GPP Subgroup**3GPP-R6, Option 40 Only**

The :DISPlay:ULR6_3GPP commands control display of the modulation analysis for 3GPP-R6 uplink.

NOTE. To use a command from this group, you must have selected *DEMULR6_3G* (modulation analysis for 3GPP-R6 uplink) in the *:INSTrument[:SElect]* command.

Command Tree	Header	Parameter
	:DISPlay	
	:ULR6_3GPP	
	:AVIew	
	:CCODE	<number>
	:CNUMBER	<number>
	:FORMat	CHANnel IQSPlit
	:IQBRanch	I Q BOTH
	:RESult	
	:ANACK	<boolean>
	:CQI	<boolean>
	:ETFCi	<boolean>
	:HAPPy	<boolean>
	:CQI	<boolean>
	:OFFSet	<boolean>
	:RSN	<boolean>
	:SIGNature	<boolean>
	:TFCI	<boolean>
	:TPC	<boolean>
	:SRATe	COMPOSITE R1920S R960S R480S R240S R120S R60S R30S R15S
	:TSLot	<number>
	:MVIew :SVIew	
	:COLor	
	[:SCALE]	
	:OFFSet	<amplitude>
	:RANge	<relative_amplitude>
	:ELENgth	<numeric_value>

```

:FORMat      OFF | CSGRam
              | CPCNumber | CPSYmbol | CPTSlot
              | SCONste | SVEctor
              | SEVM | SMERror | SPERror | SEYE
              | STABLE | CONSte | VECTOR
              | MREVm | MPEVm | MRMerror | MPMerror
              | MRPeror | MPPerror | MPCDe | MAPCde
              | MFERror | MOOOffset | MPDiscont
              | GRATio | SPECTrum

:IQComposite <boolean>
:NUMBer      SINGle | SPLit
:POWer
  [:TOTal]   <boolean>
:PREFerence  TOTal | DPCh
:RADix       BINary | OCTal | HEXadecimal
:ROtation    <numeric_value>
:X
  [:SCALE]
  :LINE       <numeric_value>
  :OFFSet     <numeric_value>
  :RANGe      <numeric_value>
:Y
  [:SCALE]
  :FIT
  :FULL
  :OFFSet     <numeric_value>
  :PUNit      RELative | ABSolute
  :RANGe      <numeric_value>

```

:DISPlay:ULR6_3GPP:AVIew:CCODE(?)

Sets or queries the channelization code to position the marker in the 3GPP-R6 uplink analysis. This command is valid when :DISPlay:ULR6_3GPP:AVIew:FORMat is set to IQSPlit.

Syntax :DISPlay:ULR6_3GPP:AVIew:CCODE <number>
:DISPlay:ULR6_3GPP:AVIew:CCODE?

Arguments <number>::=<NR1> specifies the channelization code.
Range: Channel 0 to 255.

Measurement Modes DEMULR6_3G

Examples :DISPlay:ULR6_3GPP:AVIew:CCODE 100
sets the channelization code to 100 to position the marker.

Related Commands :DISPlay:ULR6_3GPP:AVIew:FORMat

:DISPlay:ULR6_3GPP:AVIew:CNUMber(?)

Sets or queries the channel number to position the marker in the 3GPP-R6 uplink analysis. This command is valid when :DISPlay:ULR6_3GPP:AVIew:FORMat is set to CHANnel.

Syntax :DISPlay:ULR6_3GPP:AVIew:CNUMber <number>
:DISPlay:ULR6_3GPP:AVIew:CNUMber?

Arguments <number>::=<NR1> specifies channel number.
Range: Channel 0 to 12.

Measurement Modes DEMULR6_3G

Examples :DISPlay:ULR6_3GPP:AVIew:CNUMber 5
sets the channel number to 5 to position the marker.

Related Commands :DISPlay:ULR6_3GPP:AVIew:FORMat

:DISPlay:ULR6_3GPP:AVIew:FORMat(?)

Selects or queries the view format in the 3GPP-R6 uplink analysis.

Syntax :DISPlay:ULR6_3GPP:AVIew:FORMat { CHANnel | IQSPlit }
 :DISPlay:ULR6_3GPP:AVIew:FORMat?

Arguments CHANnel displays the measurement result for the channels.
 IQSPlit displays the measurement result for the I and/or Q branch. Use the :DISPlay:ULR6_3GPP:AVIew:IQBRanch command to select the I/Q branch.

Measurement Modes DEMULR6_3G

Examples :DISPlay:ULR6_3GPP:AVIew:FORMat CHANnel
 displays the measurement result for the channels.

Related Commands :DISPlay:ULR6_3GPP:AVIew:IQBRanch

:DISPlay:ULR6_3GPP:AVIew:IQBRanch(?)

Selects or queries the I/Q branch when :DISPlay:ULR6_3GPP:AVIew:FORMat is set to IQSPlit in the 3GPP-R6 uplink analysis.

Syntax :DISPlay:ULR6_3GPP:AVIew:IQBRanch { I | Q | BOTH }
 :DISPlay:ULR6_3GPP:AVIew:IQBRanch?

Arguments I displays the measurement result for the I branch.
 Q displays the measurement result for the Q branch.
 BOTH displays the measurement result for both branches.

Measurement Modes DEMULR6_3G

Examples :DISPlay:ULR6_3GPP:AVIew:IQBRanch BOTH
 displays the measurement result for both I and Q branches.

Related Commands :DISPlay:ULR6_3GPP:AVIew:FORMat

:DISPlay:ULR6_3GPP:AVIew:RESult:ANACK(?)

Determines whether to show or hide ACK/NACK in the time-slot table.

Syntax :DISPlay:ULR6_3GPP:AVIew:RESult:ANACK { OFF | ON | 0 | 1 }
:DISPlay:ULR6_3GPP:AVIew:RESult:ANACK?

Arguments OFF or 0 hides ACK/NACK in the time-slot table.
ON or 1 shows ACK/NACK in the time-slot table.

Measurement Modes DEMULR6_3G

Examples :DISPlay:ULR6_3GPP:AVIew:RESult:ANACK ON
shows ACK/NACK in the time-slot table.

:DISPlay:ULR6_3GPP:AVIew:RESult:CQI(?)

Determines whether to show or hide CQI (Channel Quality Indicator) value in the time-slot table.

Syntax :DISPlay:ULR6_3GPP:AVIew:RESult:CQI { OFF | ON | 0 | 1 }
:DISPlay:ULR6_3GPP:AVIew:RESult:CQI?

Arguments OFF or 0 hides CQI value in the time-slot table.
ON or 1 shows CQI value in the time-slot table.

Measurement Modes DEMULR6_3G

Examples :DISPlay:ULR6_3GPP:AVIew:RESult:CQI ON
shows CQI value in the time-slot table.

:DISPlay:ULR6_3GPP:AVIew:RESuLt:ETFCi(?)

Determines whether to show or hide E-TFCI (Enhanced TFCI) value in the time-slot table.

Syntax :DISPlay:ULR6_3GPP:AVIew:RESuLt:ETFCi { OFF | ON | 0 | 1 }
 :DISPlay:ULR6_3GPP:AVIew:RESuLt:ETFCi?

Arguments OFF or 0 hides E-TFCI value in the time-slot table.
 ON or 1 shows E-TFCI value in the time-slot table.

Measurement Modes DEMULR6_3G

Examples :DISPlay:ULR6_3GPP:AVIew:RESuLt:ETFCi ON
 shows E-TFCI value in the time-slot table.

:DISPlay:ULR6_3GPP:AVIew:RESuLt:HAPPy(?)

Determines whether to show or hide Happy bit value in the time-slot table.

Syntax :DISPlay:ULR6_3GPP:AVIew:RESuLt:HAPPy { OFF | ON | 0 | 1 }
 :DISPlay:ULR6_3GPP:AVIew:RESuLt:HAPPy?

Arguments OFF or 0 hides Happy bit value in the time-slot table.
 ON or 1 shows Happy bit value in the time-slot table.

Measurement Modes DEMULR6_3G

Examples :DISPlay:ULR6_3GPP:AVIew:RESuLt:HAPPy ON
 shows Happy bit value in the time-slot table.

:DISPlay:ULR6_3GPP:AVIew:RESult:OFFSet(?)

Determines whether to show or hide Subframe to Time-slot Offset (STO) in the time-slot table.

Syntax :DISPlay:ULR6_3GPP:AVIew:RESult:OFFSet { OFF | ON | 0 | 1 }
:DISPlay:ULR6_3GPP:AVIew:RESult:OFFSet?

Arguments OFF or 0 hides STO in the time-slot table.
ON or 1 shows STO in the time-slot table.

Measurement Modes DEMULR6_3G

Examples :DISPlay:ULR6_3GPP:AVIew:RESult:OFFSet ON
shows STO in the time-slot table.

:DISPlay:ULR6_3GPP:AVIew:RESult:PREAmble(?)

Determines whether to show or hide Preamble in the time-slot table.

Syntax :DISPlay:ULR6_3GPP:AVIew:RESult:PREAmble { OFF | ON | 0 | 1 }
:DISPlay:ULR6_3GPP:AVIew:RESult:PREAmble?

Arguments OFF or 0 hides Preamble in the time-slot table.
ON or 1 shows Preamble in the time-slot table.

Measurement Modes DEMULR6_3G

Examples :DISPlay:ULR6_3GPP:AVIew:RESult:PREAmble ON
shows Preamble in the time-slot table.

:DISPlay:ULR6_3GPP:AVIew:RESult:RSN(?)

Determines whether to show or hide RSN (Retransmission Sequence Number) in the time-slot table.

Syntax :DISPlay:ULR6_3GPP:AVIew:RESult:RSN { OFF | ON | 0 | 1 }
 :DISPlay:ULR6_3GPP:AVIew:RESult:RSN?

Arguments OFF or 0 hides RSN in the time-slot table.
 ON or 1 shows RSN in the time-slot table.

Measurement Modes DEMULR6_3G

Examples :DISPlay:ULR6_3GPP:AVIew:RESult:RSN ON
 shows RSN in the time-slot table.

:DISPlay:ULR6_3GPP:AVIew:RESult:SIGNature(?)

Determines whether to show or hide Signature Number in the time-slot table.

Syntax :DISPlay:ULR6_3GPP:AVIew:RESult:SIGNature { OFF | ON | 0 | 1 }
 :DISPlay:ULR6_3GPP:AVIew:RESult:SIGNature?

Arguments OFF or 0 hides Signature Number in the time-slot table.
 ON or 1 shows Signature Number in the time-slot table.

Measurement Modes DEMULR6_3G

Examples :DISPlay:ULR6_3GPP:AVIew:RESult:AGValue ON
 shows Signature Number in the time-slot table.

:DISPlay:ULR6_3GPP:AVIew:RESult:TFCI(?)

Determines whether to show or hide TFCI (Transport Format Combination Indicator) in the time-slot table.

Syntax :DISPlay:ULR6_3GPP:AVIew:RESult:TFCI { OFF | ON | 0 | 1 }
:DISPlay:ULR6_3GPP:AVIew:RESult:TFCI?

Arguments OFF or 0 hides TFCI in the time-slot table.
ON or 1 shows TFCI in the time-slot table.

Measurement Modes DEMULR6_3G

Examples :DISPlay:ULR6_3GPP:AVIew:RESult:TFCI ON
shows TFCI in the time-slot table.

:DISPlay:ULR6_3GPP:AVIew:RESult:TPC(?)

Determines whether to show or hide TPC (Transmit Power Control) value in the time-slot table.

Syntax :DISPlay:ULR6_3GPP:AVIew:RESult:TPC { OFF | ON | 0 | 1 }
:DISPlay:ULR6_3GPP:AVIew:RESult:TPC?

Arguments OFF or 0 hides TPC in the time-slot table.
ON or 1 shows TPC in the time-slot table.

Measurement Modes DEMULR6_3G

Examples :DISPlay:ULR6_3GPP:AVIew:RESult:TPC ON
shows TPC in the time-slot table.

:DISPlay:ULR6_3GPP:AVIew:SRATe(?)

Sets or queries the symbol rate for the measurement in the 3GPP-R6 uplink modulation analysis.

Syntax :DISPlay:ULR6_3GPP:AVIew:SRATe { COMPOSITE | R1920S | R960S
| R480S | R240S | R120S | R60S | R30S | R15S }
:DISPlay:ULR6_3GPP:AVIew:SRATe?

Arguments The arguments specify the symbol rates as listed in Table 2-62.

Table 2-62: Symbol rate settings

Argument	Symbol rate
COMPOSITE (default)	Corresponds to multi-rate
R1920S	1920 k
R960S	960 k
R480S	480 k
R240S	240 k
R120S	120 k
R60S	60 k
R30S	30 k
R15S	15 k

Measurement Modes DEMULR6_3G

Examples :DISPlay:ULR6_3GPP:AVIew:SRATe R960S
sets the symbol rate to 960 k.

:DISPlay:ULR6_3GPP:AVIew:TSLot(?)

Sets or queries the number of the time slot to be displayed in the 3GPP-R6 modulation analysis.

Syntax :DISPlay:ULR6_3GPP:AVIew:TSLot <number>
 :DISPlay:ULR6_3GPP:AVIew:TSLot?

Arguments <number>: :=<NR1> specifies the number of the time slot to be displayed.
 Range: Slot -15999 to 0.

Measurement Modes DEMULR6_3G

Examples :DISPlay:ULR6_3GPP:AVIew:TSLot -100
 sets the time slot number to -100.

:DISPlay:ULR6_3GPP:MVIew|:SVIew:COLor[:SCALE]:OFFSet(?)

Sets or queries the minimum value on the color, or amplitude, axis when the view displays a spectrogram in the 3GPP-R6 modulation analysis.

Syntax :DISPlay:ULR6_3GPP:MVIew|:SVIew:COLor[:SCALE]:OFFSet <value>

:DISPlay:ULR6_3GPP:MVIew|:SVIew:COLor[:SCALE]:OFFSet?

Arguments <value>::=<NRf> specifies the minimum value on the color axis.
Range: -100 to 0 dBm.

Measurement Modes DEMULR6_3G

Examples :DISPlay:ULR6_3GPP:MVIew:COLor:SCALE:OFFSet -100
sets the minimum value on the color axis in the main view to -100 dBm.

Related Commands :DISPlay:ULR6_3GPP:MVIew|:SVIew:FORMat

:DISPlay:ULR6_3GPP:MVIew|:SVIew:COLor[:SCALE]:RANGe(?)

Sets or queries full-scale value of the color, or amplitude, axis when the view displays a spectrogram in the 3GPP-R6 modulation analysis.

Syntax :DISPlay:ULR6_3GPP:MVIew|:SVIew:COLor[:SCALE]:RANGe <value>

:DISPlay:ULR6_3GPP:MVIew|:SVIew:COLor[:SCALE]:RANGe?

Arguments <value>::={ 5 | 10 | 20 | 50 } [dB] specifies full-scale value of the color axis in the spectrogram view.

Measurement Modes DEMULR6_3G

Examples :DISPlay:ULR6_3GPP:MVIew:COLor:SCALE:RANGe 50
sets full-scale value of the color axis to 50 dB.

Related Commands :DISPlay:ULR6_3GPP:MVIew|:SVIew:FORMat

:DISPlay:ULR6_3GPP:MView|:SVIew:ELENgth(?)

Selects or queries the eye length of the eye diagram in the main view or subview during the 3GPP-R6 modulation analysis. This command is valid when :DISPlay:ULR6_3GPP:MView|:SVIew:FORMat is set to SIEYe, SQEYe, or STEYe.

Syntax :DISPlay:ULR6_3GPP:MView|:SVIew:ELENgth <value>
:DISPlay:ULR6_3GPP:MView|:SVIew:ELENgth?

Arguments <value>::=<NR1> specifies the eye length of the eye diagram.
Range: 1 to 16.

Measurement Modes DEMULR6_3G

Examples :DISPlay:ULR6_3GPP:MView:ELENgth 8
sets the eye length to 8 in the main view.

Related Commands :DISPlay:ULR6_3GPP:MView|:SVIew:FORMat

:DISPlay:ULR6_3GPP:MView|:SVIew:FORMat(?)

Selects or queries the main view or subview display format in the 3GPP-R6 uplink modulation analysis.

Syntax :DISPlay:ULR6_3GPP:MView|:SVIew:FORMat { OFF | CSGRam
| CPCNumber | CPSYmbol | CPTSlot | SCONste | SVEctor
| SEVM | SMERror | SPERror | SEYE | STABLE | CONSte | VECTor
| MREVm | MPEVm | MRMerror | MPMerror | MRPeror | MPPerror
| MPCDe | MAPCde | MFERror | MOOffset | MPDiscont
| GRATio | SPECTrum }

:DISPlay:ULR6_3GPP:MView|:SVIew:FORMat?

Arguments Table 2-54 shows the arguments and display formats.

Table 2-63: 3GPP-R6 uplink modulation analysis display formats

Argument	Format
OFF	Hides all measurement results (main view only)
CSGRam	Code domain power spectrogram
CPCNumber	Code domain power versus Channelization code
CPSYmbol	Code domain power versus Symbol
CPTSlot	Code domain power versus Time slot
SCONste	Symbol constellation
SVEctor	Symbol vector
SEVM	Symbol EVM
SMERror	Symbol amplitude error
SPERror	Symbol phase error
SEYE	Symbol eye diagram
STABLE	Symbol table
CONSte	Constellation and modulation accuracy measurement results
VECTor	Vector locus
MREVm	Modulation accuracy versus Time slot: EVM (rms)
MPEVm	Modulation accuracy versus Time slot: EVM (peak)
MRMerror	Modulation accuracy versus Time slot: Amplitude error (rms)
MPMerror	Modulation accuracy versus Time slot: Amplitude error (peak)
MRPeror	Modulation accuracy versus Time slot: Phase error (rms)
MPPerror	Modulation accuracy versus Time slot: Phase error (peak)

Table 2-63: 3GPP-R6 uplink modulation analysis display formats (Cont.)

Argument	Format
MPCDe	Modulation accuracy versus Time slot: PCDE
MAPCde	Modulation accuracy versus Time slot: PCDE (active)
MFERror	Modulation accuracy versus Time slot: Frequency error
MOOOffset	Modulation accuracy versus Time slot: Origin offset
MPDiscont	Modulation accuracy versus Time slot: Phase discontinuity
GRATio	Gain ratio
SPECtrum	Spectrum (subview only)

Measurement Modes DEMULR6_3G

Examples :DISPlay:ULR6_3GPP:MView:FORMat CSGRam
displays the code domain power spectrogram in the main view.

:DISPlay:ULR6_3GPP:MView|:SView:IQComposite(?)

Determines whether to display IQ composite in the symbol constellation measurement. This command is valid when :DISPlay:ULR6_3GPP:AVIew:FORMat is set to CHANnel, and :DISPlay:ULR6_3GPP:MView|:SView:FORMat is set to SCONste.

Syntax :DISPlay:ULR6_3GPP:MView|:SView:IQComposite { OFF | ON | 0 | 1 }
:DISPlay:ULR6_3GPP:MView|:SView:IQComposite?

Arguments OFF or 0 displays the I or Q component only for the specified channel.
ON or 1 displays IQ composite of the specified channel and other channel(s) transmitted simultaneously.

Measurement Modes DEMULR6_3G

Examples :DISPlay:ULR6_3GPP:MView:IQComposite ON
displays IQ composite of the specified channel and other channel(s) transmitted simultaneously in the main view.

Related Commands :DISPlay:ULR6_3GPP:AVIew:FORMat,
:DISPlay:ULR6_3GPP:MView|:SView:FORMat

:DISPlay:ULR6_3GPP:MView|:SVIew:NUMBer(?)

Selects or queries the number of graphs displayed on the main view or subview in the 3GPP-R6 uplink analysis.

Syntax :DISPlay:ULR6_3GPP:MView|:SVIew:NUMBer { SINGle | SPLit }
 :DISPlay:ULR6_3GPP:MView|:SVIew:NUMBer?

Arguments SINGle displays one graph on the view.
 SPLit displays two graphs on the view.

Measurement Modes DEMULR6_3G

Examples :DISPlay:ULR6_3GPP:MView:NUMBer SPLit
 displays two graphs on the main view.

:DISPlay:ULR6_3GPP:MView|:SView:POWer[:TOTa1](?)

Determines whether to display the total power for each time slot in the Code power versus Time slot view. This command is valid when :DISPlay:ULR6_3GPP:MView|:SView:FORMat is set to CPTSlot (Code power versus Time slot).

Syntax :DISPlay:ULR6_3GPP:MView|:SView:POWer[:TOTa1]
 { ON | OFF | 1 | 0 }

 :DISPlay:ULR6_3GPP:MView|:SView:POWer[:TOTa1]?

Arguments OFF or 0 displays power of the channel specified with the :DISPlay:ULR6_3GPP:AView:CNUMBER command.

 ON or 1 displays the total power of all channels for each time slot.

Measurement Modes DEMULR6_3G

Examples :DISPlay:ULR6_3GPP:MView:POWer:TOTa1 ON
 displays the total power of all channels for each time slot in the main view.

Related Commands :DISPlay:ULR6_3GPP:AView:CNUMBER,
 :DISPlay:ULR6_3GPP:MView|:SView:FORMat

:DISPlay:ULR6_3GPP:MView|:SVIew:PREFERENCE(?)

Selects or queries the power reference in the main view or subview in the 3GPP-R6 uplink analysis. This command is valid when :DISPlay:ULR6_3GPP:MView|:SVIew:FORMat is set to CSGRam, CPCNumber, or CPSYmbol.

Syntax :DISPlay:ULR6_3GPP:MView|:SVIew:PREFERENCE { TOTa1 | DPCCh }
:DISPlay:ULR6_3GPP:MView|:SVIew:PREFERENCE?

Arguments TOTa1 selects the total power as the power reference.
DPCCh selects the DPCCH power as the power reference.

Measurement Modes DEMULR6_3G

Examples :DISPlay:ULR6_3GPP:MView:PREFERENCE TOTa1
selects the total power as the power reference.

Related Commands :DISPlay:ULR6_3GPP:MView|:SVIew:FORMat

:DISPlay:ULR6_3GPP:MView|:SView:RADix(?)

Selects or queries the base of symbols on the main view or subview in the 3GPP-R6 modulation analysis. This command is valid when :DISPlay:ULR6_3GPP:MView|:SView:FORMat is STABle (symbol table).

Syntax :DISPlay:ULR6_3GPP:MView|:SView:RADix
 { BINary | OCTal | HEXadecimal }

 :DISPlay:ULR6_3GPP:MView|:SView:RADix?

Arguments BINary selects binary notation.

 OCTal selects octal notation.

 HEXadecimal selects hexadecimal notation.

Measurement Modes DEMULR6_3G

Examples :DISPlay:ULR6_3GPP:MView:RADix BINary
 selects binary notation for the base of symbols in the main view.

Related Commands :DISPlay:ULR6_3GPP:MView|:SView:FORMat

:DISPlay:ULR6_3GPP:MView|:SVIew:ROTation(?)

Selects or queries the rotation of the symbol table in the main view or subview during the 3GPP-R6 modulation analysis. This command is valid when :DISPlay:ULR6_3GPP:MView|:SVIew:FORMat is set to STABle (symbol table).

Syntax :DISPlay:ULR6_3GPP:MView|:SVIew:ROTation <value>
:DISPlay:ULR6_3GPP:MView|:SVIew:ROTation?

Arguments <value>::=<NR1> specifies the rotation of the symbol table.
Range: 0 to 3.

Measurement Modes DEMULR6_3G

Examples :DISPlay:ULR6_3GPP:MView:ROTation 1
sets the rotation to 1 in the main view.

Related Commands :DISPlay:ULR6_3GPP:MView|:SVIew:FORMat

:DISPlay:ULR6_3GPP:MView|:SVIew:X[:SCALe]:LINE(?)

Sets or queries the position of the horizontal line when the main view or subview displays the gain ratio measurement. This command is valid when :DISPlay:ULR6_3GPP:MView|:SVIew:FORMat is set to GRATio.

Syntax :DISPlay:ULR6_3GPP:MView|:SVIew:X[:SCALe]:LINE <value>
:DISPlay:ULR6_3GPP:MView|:SVIew:X[:SCALe]:LINE?

Arguments <value>::=<NRf> specifies the position of the horizontal line.
Range: -100 to 30 dBm.

Measurement Modes DEMULR6_3G

Examples :DISPlay:ULR6_3GPP:MView:X:SCALe:LINE -10
positions the horizontal line at -10 dBm.

Related Commands :DISPlay:ULR6_3GPP:MView|:SVIew:FORMat

:DISPlay:ULR6_3GPP:MView|:SVIew:X[:SCALe]:OFFSet(?)

Sets or queries the minimum horizontal value (left edge) on the main view or subview in the 3GPP-R6 modulation analysis.

Syntax :DISPlay:ULR6_3GPP:MView|:SVIew:X[:SCALe]:OFFSet <value>
 :DISPlay:ULR6_3GPP:MView|:SVIew:X[:SCALe]:OFFSet?

Arguments <value>::=<NRf> specifies the minimum horizontal value.
Refer to *Note on Horizontal Scaling* on page 2-184 for setting the scale.

Measurement Modes DEMULR6_3G

Examples :DISPlay:ULR6_3GPP:MView:X:SCALe:OFFSet 0
sets the minimum horizontal value to channel 0 when the main view displays a code domain power spectrogram.

Related Commands :DISPlay:ULR6_3GPP:MView|:SVIew:FORMat

:DISPlay:ULR6_3GPP:MView|:SVIew:X[:SCALe]:RANGe(?)

Sets or queries full-scale value of the horizontal axis in the main view or subview in the 3GPP-R6 modulation analysis.

Syntax :DISPlay:ULR6_3GPP:MView|:SVIew:X[:SCALe]:RANGe <value>
 :DISPlay:ULR6_3GPP:MView|:SVIew:X[:SCALe]:RANGe?

Arguments <value>::=<NRf> specifies full-scale value of the horizontal axis.
Refer to *Note on Horizontal Scaling* on page 2-184 for setting the scale.

Measurement Modes DEMULR6_3G

Examples :DISPlay:ULR6_3GPP:MView:X:SCALe:RANGe 512
sets the horizontal full-scale value to 512 channels when the main view displays a code domain power spectrogram.

Related Commands :DISPlay:ULR6_3GPP:MView|:SVIew:FORMat

:DISPlay:ULR6_3GPP:MView|:SVIew:Y[:SCALe]:FIT (No Query Form)

Runs auto-scale on the main view or subview in the 3GPP-R6 modulation analysis. The auto-scale automatically sets the start value and scale of the vertical axis to best display the waveform.

This command is valid when :DISPlay:ULR6_3GPP:MView|:SVIew:FORMat is CPHortcode, CPSYmbol, CPTSlot, SEVM, SMERror, or SPERror.

Syntax :DISPlay:ULR6_3GPP:MView|:SVIew:Y[:SCALe]:FIT

Arguments None

Measurement Modes DEMULR6_3G

Examples :DISPlay:ULR6_3GPP:MView|:SVIew:Y:SCALe:FIT
runs the auto-scale on the main view.

Related Commands :DISPlay:ULR6_3GPP:MView|:SVIew:FORMat

:DISPlay:ULR6_3GPP:MView|:SVIew:Y[:SCALe]:FULL (No Query Form)

Sets the main view or subview's vertical axis to the default full-scale value in the 3GPP-R6 modulation analysis.

This command is valid when :DISPlay:ULR6_3GPP:MView|:SVIew:FORMat is set to CPHortcode, CPSYmbol, CPTSlot, SEVM, SMERror, or SPERror.

Syntax :DISPlay:ULR6_3GPP:MView|:SVIew:Y[:SCALe]:FULL

Arguments None

Measurement Modes DEMULR6_3G

Examples :DISPlay:ULR6_3GPP:MView:Y:SCALe:FULL
sets the main view's vertical axis to the default full-scale value.

Related Commands :DISPlay:ULR6_3GPP:MView|:SVIew:FORMat

:DISPlay:ULR6_3GPP:MView|:SVIew:Y[:SCALe]:OFFSet(?)

Sets or queries the minimum vertical value (bottom) in the main view or subview in the 3GPP-R6 modulation analysis.

This command is valid when :DISPlay:ULR6_3GPP:MView|:SVIew:FORMat is set to CPHortcode, CPSYmbol, CPTSlot, SEVM, SMERror, or SPERror.

Syntax :DISPlay:ULR6_3GPP:MView|:SVIew:Y[:SCALe]:OFFSet <value>
 :DISPlay:ULR6_3GPP:MView|:SVIew:Y[:SCALe]:OFFSet?

Arguments <value>::=<NRf> specifies the minimum vertical value in the main view. The valid range depends on the display format. Refer to Table D-5 in *Appendix D*.

Measurement Modes DEMULR6_3G

Examples :DISPlay:ULR6_3GPP:MView:Y:SCALe:OFFSet 0
 sets the bottom of the vertical axis to channel 0 when the main view displays a code domain power spectrogram.

Related Commands :DISPlay:ULR6_3GPP:MView|:SVIew:FORMat

:DISPlay:ULR6_3GPP:MView|:SVIew:Y[:SCALe]:PUNit(?)

Selects or queries the unit on the Y (color) axis in the main view or subview during the 3GPP-R6 modulation analysis.

This command is valid when :DISPlay:ULR6_3GPP:MView|:SVIew:FORMat is set to CSGRam, CPShortcode, CPSYmbol, or CPTSlot.

Syntax :DISPlay:ULR6_3GPP:MView|:SVIew:Y[:SCALe]:PUNit { RELative | ABSolute }

:DISPlay:ULR6_3GPP:MView|:SVIew:Y[:SCALe]:PUNit?

Arguments RELative represents the relative channel power to the total power of all the channels along the Y axis in dB.

ABSolute represents the absolute power of each channel along the Y axis in dBm.

Measurement Modes DEMULR6_3G

Examples :DISPlay:ULR6_3GPP:MView|:SVIew:Y:SCALe:PUNit RELative
represents the relative power along the Y axis in the main view.

Related Commands :DISPlay:ULR6_3GPP:MView|:SVIew:FORMat

:DISPlay:ULR6_3GPP:MView|:SVIew:Y[:SCALe]:RANGe(?)

Sets or queries full-scale value of the vertical axis in the main view or subview in the 3GPP-R6 modulation analysis.

This command is valid when :DISPlay:ULR6_3GPP:MView|:SVIew:FORMat is set to CSGRam, CPHortcode, CPSYmbol, CPTSlot, SEVM, SMERror, or SPERror.

Syntax :DISPlay:ULR6_3GPP:MView|:SVIew:Y[:SCALe]:RANGe <value>

:DISPlay:ULR6_3GPP:MView|:SVIew:Y[:SCALe]:RANGe?

Arguments <value>: :=<NRf> specifies full-scale value of the vertical axis. The valid range depends on the display format. Refer to Table D-5 in *Appendix D*.

Measurement Modes DEMULR6_3G

Examples :DISPlay:ULR6_3GPP:MView:Y:SCALe:RANGe 50
sets the vertical full-scale value to 50 slots when the main view displays a power codogram.

Related Commands :DISPlay:ULR6_3GPP:MView|:SVIew:FORMat

:FETCh Commands

The :FETCh commands retrieve the measurements from the data taken by the latest INITiate command.

If you want to perform a FETCh operation on fresh data, use the :READ commands on page 2-917. The :READ commands acquire a new input signal and fetch the measurement results from that data.

Invalid data is returned as -1000.

NOTE. To use a :FETCh command, you must have set a measurement mode for the FETCh operation using the :INSTRument[:SElect] command (refer to page 2-884).

Command Tree

Header	Parameter
:FETCh	
:ADEMod	
:AM?	
:RESult?	
:FM?	
:RESult?	
:PM?	
:PSPectrum?	
:CCDF?	
:DISTRibution:CCDF?	
:OVIew?	
:PULSe?	ALL WIDTH PPOwer OORatio RIPPlE PERiod DCYClE PHASe CHPower OBWidth EBWidth FREQuency
:SPECTrum?	
:TAMPLitude?	
:TFREquency?	
:SPECTrum?	
:ACPower?	
:CFREquency?	
:CHPower?	
:CNRatio?	
:EBWidth?	
:OBWidth?	
:SPURious?	
:TRANsient	
:FVTime?	
:IQVTime?	
:PVTime?	

:FETCh:ADEMod:AM? (Query Only)

Returns the results of the AM signal analysis in time series.

Syntax :FETCh:ADEMod:AM?

Arguments None

Returns #<num_digit><num_byte><data(1)><data(2)>...<data(n)>

Where

<Num_digit> is the number of digits in <Num_byte>.

<Num_byte> is the number of bytes of data that follow.

<Data(n)> is the percentage modulation data in percent (%) for the point n.

4-byte little endian floating-point format specified in IEEE 488.2

n: Max 512000 (= 1024 points × 500 frames)

Measurement Modes DEMADEM

Examples :FETCh:ADEMod:AM?
might return #41024xxxx... (1024-byte data) for the results of the AM signal analysis.

Related Commands :INSTrument[:SElect]

:FETCh:ADEMod:AM:RESult? (Query Only)

Returns the measurement results of the AM signal analysis.

Syntax :FETCh:ADEMod:AM:RESult?

Arguments None

Returns <+AM>,<-AM>,<Total_AM>

Where

<+AM>::=<NRf> is the positive peak AM value in percent (%).

<-AM>::=<NRf> is the negative peak AM value in percent (%).

<Total_AM>::=<NRf> is the total AM value: (peak-peak AM value) / 2 in percent (%).

Measurement Modes DEMADEM

Examples :FETCh:ADEMod:AM:RESult?
might return 37.34,-48.75,43.04.

Related Commands :INSTRument[:SElect]

:FETCh:ADEMod:FM? (Query Only)

Returns the results of the FM signal analysis in time series.

Syntax :FETCh:ADEMod:FM?

Arguments None

Returns #<Num_digit><Num_byte><Data(1)><Data(2)>...<Data(n)>

Where

<Num_digit> is the number of digits in <Num_byte>.

<Num_byte> is the number of bytes of data that follow.

<Data(n)> is the frequency shift data in Hz for the point n.

4-byte little endian floating-point format specified in IEEE 488.2

n: Max 512000 (= 1024 points × 500 frames)

Measurement Modes DEMADEM

Examples :FETCh:ADEMod:FM?
might return #41024xxxx... (1024-byte data) for the results of the FM signal analysis.

Related Commands :INSTrument[:SElect]

:FETCh:ADEMod:FM:RESult? (Query Only)

Returns the measurement results of the FM signal analysis.

Syntax :FETCh:ADEMod:FM:RESult?

Arguments None

Returns <+Pk_Freq_Dev>,<-Pk_Freq_Dev>,<P2P_Freq_Dev>,<P2P_Freq_Dev/2>,<RMS_Freq_Dev>

Where

<+Pk_Freq_Dev>::=<NRf> is the positive peak frequency deviation in Hz.

<-Pk_Freq_Dev>::=<NRf> is the negative peak frequency deviation in Hz.

<P2P_Freq_Dev>::=<NRf> is the peak-to-peak frequency deviation in Hz.

<P2P_Freq_Dev/2>::=<NRf> is (peak-to-peak frequency deviation) / 2 in Hz.

<RMS_Freq_Dev>::=<NRf> is the RMS frequency deviation in Hz.

Measurement Modes DEMADEM

Examples :FETCh:ADEMod:FM:RESult?
might return 1.13e+4,-1.55e+4,2.48e+4,1.24e+4,1.03e+4.

Related Commands :INSTrument[:SElect]

:FETCh:ADEMod:PM? (Query Only)

Returns the results of the PM signal analysis in time series.

Syntax :FETCh:ADEMod:PM?

Arguments None

Returns #<Num_digit><Num_byte><Data(1)><Data(2)>...<Data(n)>

Where

<Num_digit> is the number of digits in <Num_byte>.

<Num_byte> is the number of bytes of data that follow.

<Data(n)> is the phase shift data in degrees for the point n.

4-byte little endian floating-point format specified in IEEE 488.2

n: Max 512000 (= 1024 points × 500 frames)

Measurement Modes DEMADEM

Examples :FETCh:ADEMod:PM?

might return #41024xxxx... (1024-byte data) for the results of the PM signal analysis.

Related Commands :INSTrument[:SElect]

:FETCh:ADEMod:PSpectrum? (Query Only)

Returns spectrum data of the pulse spectrum measurement in the analog modulation analysis.

Syntax :FETCh:ADEMod:PSpectrum?

Arguments None

Returns #<Num_digit><Num_byte><Data(1)><Data(2)>...<Data(n)>

Where

<Num_digit> is the number of digits in <Num_byte>.

<Num_byte> is the number of bytes of data that follow.

<Data(n)> is the spectrum amplitude in dBm.

4-byte little endian floating-point format specified IEEE 488.2.

n: Max 240001

Measurement Modes DEMADEM

Examples :FETCh:ADEMod:PSpectrum?
might return #43200xxxx... (3200-byte data) for the spectrum data.

Related Commands :INSTRument[:SElect]

:FETCh:CCDF? (Query Only)

Returns the CCDF measurement results.

Syntax :FETCh:CCDF?

Arguments None

Returns <meanpower>,<peakpower>,<cfactor>

Where

<meanpower>::=<NRf> is the average power measured value in dBm.

<peakpower>::=<NRf> is the peak power measured value in dBm.

<cfactor>::=<NRf> is the crest factor in dB.

Measurement Modes TIMCCDF

Examples :FETCh:CCDF?
might return -11.16,-8.18,2.96 for the CCDF measurement results.

Related Commands :FETCh:DISTRibution:CCDF?, :INSTrument[:SElect]

:FETCh:DISTRibution:CCDF? (Query Only)

Returns the CCDF trace data in the CCDF measurement.

Syntax :FETCh:DISTRibution:CCDF?

Arguments None

Returns #<Num_digit><Num_byte><Data(1)><Data(2)>...<Data(n)>

Where

<Num_digit> is the number of digits in <Num_byte>.

<Num_byte> is the number of bytes of data that follow.

<Data(n)> is the phase shift data in degrees for the point n.

4-byte little endian floating-point format specified in IEEE 488.2

n: Max 10001

Invalid data is returned as -1000.

Measurement Modes TIMCCDF

Examples :FETCh:DISTRibution:CCDF?
might return #41024xxxx... (1024-byte data) for the CCDF trace data in the CCDF measurement.

Related Commands :FETCh:CCDF?, :INSTrument[:SELect]

:FETCh:OVlew? (Query Only)

Returns the minimum and maximum values for each 1024-point segment of waveform data displayed on the overview in the Demod (modulation analysis) and the Time (time analysis) modes.

NOTE. The :CONFigure:OVlew command must be run to turn the measurement off before the :FETCh:OVlew command is executed.

Syntax :FETCh:OVlew?

Arguments None

Returns #<Num_digit><Num_byte><MinData(1)><MaxData(1)>...
<MinData(n)><MaxData(n)>

Where

<Num_digit> is the number of digits in <Num_byte>.

<Num_byte> is the number of bytes of data that follow.

<MinData(n)> is the minimum data in dBm for each 1024 data point segment.

4-byte little endian floating-point format specified in IEEE 488.2

<MaxData(n)> is the maximum data in dBm for each 1024 data point segment.

4-byte little endian floating-point format specified in IEEE 488.2

n: Max 16000 (standard) / 64000 (Option 02)

Measurement Modes All Demod modes, all Time modes

Examples :FETCh:OVlew?
might return #510240xxx... (10240-byte data) representing the minimum and the maximum values of waveform displayed on the overview.

Related Commands :CONFigure:OVlew, :INSTrument[:SElect]

:FETCh:PULSe? (Query Only)

Returns the result of the pulse characteristics analysis.

Syntax :FETCh:PULSe? { ALL | WIDTH | PPOWer | OORatio | RIPPlE | PERiod
| DCYClE | PHASe | CHPower | OBWidth | EBWidth | FREQuency }

Arguments Information queried is listed below for each of the arguments:

Table 2-64: Queried information

Argument	Information queried
ALL	All
WIDTH	Pulse width
PPOWer	Maximum (peak) power in the pulse on-time
OORatio	Difference between the on-time power and off-time power
RIPPlE	Difference between the maximum and the minimum power in pulse-on time
PERiod	Time between the pulse rising edge and the next rising edge
DCYClE	Ratio of the pulse width to the pulse repetition interval (PRI)
PHASe	Phase at a certain point of each pulse
CHPower	Channel power of the pulse on-time spectrum
OBWidth	OBW (Occupied Bandwidth) of the pulse on-time spectrum
EBWidth	EBW (Emission Bandwidth) of the pulse on-time spectrum
FREQuency	Frequency deviation in the pulse on-time

Returns Returns are listed below for each of the arguments.

ALL. <width>,<ppower>,<ooratio>,<ripple>,<period>,<dcycle>,<phase>,<chp>,<obw>,<ebw>,<freq>

Where

<width>::=<NRf> is the pulse width in s.
 <ppower>::=<NRf> is the peak power in W.
 <ooratio>::=<NRf> is the on/off ratio in dB.
 <ripple>::=<NRf> is the pulse ripple in W.
 <period>::=<NRf> is the pulse repetition interval in s.
 <dcycle>::=<NRf> is the duty cycle in percent (%).
 <phase>::=<NRf> is the pulse-pulse phase in degrees.
 <chp>::=<NRf> is the channel power in W.
 <obw>::=<NRf> is the OBW in Hz.
 <ebw>::=<NRf> is the EBW in Hz.
 <freq>::=<NRf> is the frequency deviation in Hz.

WIDTH. #<Num_digit><Num_byte><Width(1)><Width(2)>...<Width(n)>

Where

<Num_digit> is the number of digits in <Num_byte>.
 <Num_byte> is the number of bytes of data that follow.
 <Width(n)> is the pulse width value for each pulse number.
 4-byte little endian floating-point format specified in IEEE 488.2
 n: Max 1000

PPOWER. #<Num_digit><Num_byte><Ppower(1)><Ppower(2)>...<Ppower(n)>

Where

<Num_digit> is the number of digits in <Num_byte>.
 <Num_byte> is the number of bytes of data that follow.
 <Power(n)> is the peak power value for each pulse number.
 4-byte little endian floating-point format specified in IEEE 488.2
 n: Max 1000

OORATIO. #<Num_digit><Num_byte><Ooratio(1)><Ooratio(2)>...<Ooratio(n)>

Where

<Num_digit> is the number of digits in <Num_byte>.
 <Num_byte> is the number of bytes of data that follow.
 <Ooratio(n)> is the on/off ratio value for each pulse number.
 4-byte little endian floating-point format specified in IEEE 488.2
 n: Max 1000

RIPlle. #<Num_digit><Num_byte><Ripple(1)><Ripple(2)>...<Ripple(n)>

Where

<Num_digit> is the number of digits in <Num_byte>.

<Num_byte> is the number of bytes of data that follow.

<Ripple(n)> is the ripple value for each pulse number.

4-byte little endian floating-point format specified in IEEE 488.2

n: Max 1000

PERiod. #<Num_digit><Num_byte><Period(1)><Period(2)>...<Period(n)>

Where

<Num_digit> is the number of digits in <Num_byte>.

<Num_byte> is the number of bytes of data that follow.

<Period(n)> is the pulse repetition interval value for each pulse number.

4-byte little endian floating-point format specified in IEEE 488.2

n: Max 1000

DCYClE. #<Num_digit><Num_byte><Dcycle(1)><Dcycle(2)>...<Dcycle(n)>

Where

<Num_digit> is the number of digits in <Num_byte>.

<Num_byte> is the number of bytes of data that follow.

<Dcycle(n)> is the duty value for each pulse number.

4-byte little endian floating-point format specified in IEEE 488.2

n: Max 1000

PHASe. #<Num_digit><Num_byte><Phase(1)><Phase(2)>...<Phase(n)>

Where

<Num_digit> is the number of digits in <Num_byte>.

<Num_byte> is the number of bytes of data that follow.

<Phase(n)> is the pulse-pulse phase value for each pulse number.

4-byte little endian floating-point format specified in IEEE 488.2

n: Max 1000

CHPower. #<Num_digit><Num_byte><Chp(1)><Chp(2)>...<Chp(n)>

Where

<Num_digit> is the number of digits in <Num_byte>.

<Num_byte> is the number of bytes of data that follow.

<Chp(n)> is the Channel Power value for each pulse number.

4-byte little endian floating-point format specified in IEEE 488.2

n: Max 1000

OBWidth. #<Num_digit><Num_byte><Obw(1)><Obw(2)>...<Obw(n)>

Where

<Num_digit> is the number of digits in <Num_byte>.

<Num_byte> is the number of bytes of data that follow.

<Obw(n)> is the OBW value for each pulse number.

4-byte little endian floating-point format specified in IEEE 488.2

n: Max 1000

EBWidth. #<Num_digit><Num_byte><Ebw(1)><Ebw(2)>...<Ebw(n)>

Where

<Num_digit> is the number of digits in <Num_byte>.

<Num_byte> is the number of bytes of data that follow.

<Ebw(n)> is the EBW value for each pulse number.

4-byte little endian floating-point format specified in IEEE 488.2

n: Max 1000

FREquency. #<Num_digit><Num_byte><Freq(1)><Freq(2)>...<Freq(n)>

Where

<Num_digit> is the number of digits in <Num_byte>.

<Num_byte> is the number of bytes of data that follow.

<Freq(n)> is the carrier frequency value for each pulse number.

4-byte little endian floating-point format specified in IEEE 488.2

n: Max 1000

Measurement Modes

TIMPULSE

Examples

:FETCh:PULSe? WIDTH

might return #3500xxxx... (500-byte data) for the pulse width measurement result.

Related Commands

:INSTrument[:SElect]

:FETCh:PULSe:SPECTrum? (Query Only)

Returns the spectrum data of the frequency domain measurement in the pulse characteristics analysis.

This query command is valid when :DISPlay:PULSe:SVIew:FORMat is set to CHPowr, OBWidth, or EBWidth.

Syntax :FETCh:PULSe:SPECTrum?

Arguments None

Returns #<Num_digit><Num_byte><Data(1)><Data(2)>...<Data(n)>

Where

<Num_digit> is the number of digits in <Num_byte>.

<Num_byte> is the number of bytes of data that follow.

<Data(n)> is the spectrum in dBm.

4-byte little endian floating-point format specified IEEE 488.2.

n: Max 16384

Measurement Modes TIMPULSE

Examples :FETCh:PULSe:SPECTrum?
might return #43200xxxx... (3200-byte data) for the spectrum data.

Related Commands :DISPlay:PULSe:SVIew:FORMat, :INSTrument[:SElect]

:FETCh:PULSe:TAMPlitude? (Query Only)

Returns the time domain amplitude data of the time domain measurement in the pulse characteristics analysis.

This query command is valid when :DISPlay:PULSe:SVIew:FORMat is set to WIDTH, PPOWer, OORatio, RIPple, PERiod, DCYCLE, or PHASE.

Syntax :FETCh:PULSe:TAMPlitude?

Arguments None

Returns #<Num_digit><Num_byte><Data(1)><Data(2)>...<Data(n)>

Where

<Num_digit> is the number of digits in <Num_byte>.

<Num_byte> is the number of bytes of data that follow.

<Data(n)> is the absolute power for each data in watts.

4-byte little endian floating-point format specified IEEE 488.2.

n: Max 262,144

Measurement Modes TIMPULSE

Examples :FETCh:PULSe:TAMPlitude?
might return #43200xxxx... (3200-byte data) for the time domain amplitude.

Related Commands :DISPlay:PULSe:SVIew:FORMat, :INSTrument[:SElect]

:FETCh:PULSe:TFRequency? (Query Only)

Returns the frequency deviation measurement results in the pulse characteristics analysis.

This query command is valid when :DISPlay:PULSe:SVIew:FORMat is set to FREQuency.

Syntax :FETCh:PULSe:TFRequency?

Arguments None

Returns #<Num_digit><Num_byte><Data(1)><Data(2)>...<Data(n)>

Where

<Num_digit> is the number of digits in <Num_byte>.

<Num_byte> is the number of bytes of data that follow.

<Data(n)> is the frequency deviation value in Hz on the time axis.

4-byte little endian floating-point format specified IEEE 488.2.

n: Max 262,144

Measurement Modes TIMPULSE

Examples :FETCh:PULSe:TFRequency?
might return #43200xxxx... (3200-byte data) for the time domain frequency.

Related Commands :DISPlay:PULSe:SVIew:FORMat, :INSTrument[:SElect]

:FETCh:SPECTrum? (Query Only)

Returns spectrum waveform data in the S/A (spectrum analysis) mode.

Syntax :FETCh:SPECTrum?

Arguments None

Returns #<Num_digit><Num_byte><Data(1)><Data(2)>...<Data(n)>

Where

<Num_digit> is the number of digits in <Num_byte>.

<Num_byte> is the number of bytes of data that follow.

<Data(n)> is the amplitude spectrum in dBm.

4-byte little endian floating-point format specified in IEEE 488.2

n: Max 400000 (= 800 points × 500 frames)

Measurement Modes SANORMAL, SASGRAM, SARTIME, SAZRTIME, SAUL3G

Examples :FETCh:SPECTrum?
might return #43200xxxx... (3200-byte data) for the spectrum waveform data.

Related Commands :INSTrument[:SElect]

:FETCh:SPECTrum:ACPower? (Query Only)

Returns the results of adjacent channel leakage power ratio (ACPR) measurement in the S/A (spectrum analysis) mode.

Syntax :FETCh:SPECTrum:ACPower?

Arguments None

Returns <chpower>,<acpm1>,<acpp1>,<acpm2>,<acpp2>,<acpm3>,<acpp3>

Where

<chpower>::=<NRf> is the channel power measured value in dBm.

<acpm1>::=<NRf> is the first lower adjacent channel ACPR in dB.

<acpp1>::=<NRf> is the first upper adjacent channel ACPR in dB.

<acpm2>::=<NRf> is the second lower adjacent channel ACPR in dB.

<acpp2>::=<NRf> is the second upper adjacent channel ACPR in dB.

<acpm3>::=<NRf> is the third lower adjacent channel ACPR in dB.

<acpp3>::=<NRf> is the third upper adjacent channel ACPR in dB.

NOTE. All the values may not be returned when the adjacent channel(s) goes out of the span due to the settings of the channel bandwidth and spacing (refer to the [:SENSe]:ACPower subgroup). For example, if the third adjacent channel goes out of the span, the response is <chpower>,<acpm1>,<acpp1>,<acpm2>,<acpp2>; <acpm3> and <acpp3> are not returned.

Measurement Modes SANORMAL, SASGRAM, SARTIME, SAUL3G

Examples :FETCh:SPECTrum:ACPower?
might return -11.38,-59.41,-59.51,-59.18,-59.31,-59.17,-59.74 for the ACPR measurement results.

Related Commands :INSTrument[:SElect], [:SENSe]:ACPower subgroup

:FETCh:SPECTrum:CFRequency? (Query Only)

Returns the results of the carrier frequency measurement in the S/A (spectrum analysis) mode.

Syntax :FETCh:SPECTrum:CFRequency?

Arguments None

Returns <cfreq>:::=<NRf> is the measured value of carrier frequency in Hz.

Measurement Modes SANORMAL, SASGRAM, SARTIME, SAUL3G

Examples :FETCh:SPECTrum:CFRequency?
might return 846187328.5 for the carrier frequency.

Related Commands :INSTrument[:SElect]

:FETCh:SPECTrum:CHPower? (Query Only)

Returns the results of the channel power measurement in the S/A (spectrum analysis) mode.

Syntax :FETCh:SPECTrum:CHPower?

Arguments None

Returns <chpower>:::=<NRf> is the channel power measured value in dBm.

Measurement Modes SANORMAL, SASGRAM, SARTIME, SAUL3G

Examples :FETCh:SPECTrum:CHPower?
might return -1.081 for the measurement results of channel power.

Related Commands :INSTrument[:SElect]

:FETCh:SPECTrum:CNRatio? (Query Only)

Returns the results of the carrier-to-noise ratio (C/N) measurement in the S/A (spectrum analysis) mode.

Syntax : FETCh:SPECTrum:CNRatio?

Arguments None

Returns <ctn>,<ctno>

Where

<ctn>::=<NRf> is the measured value of C/N in dB.

<ctno>::=<NRf> is the measured value of C/No in dB/Hz.

Measurement Modes SANORMAL, SASGRAM, SARTIME, SAUL3G

Examples : FETCh:SPECTrum:CNRatio?
might return 75.594,125.594 for the C/N measurement results.

Related Commands :INSTRument[:SElect]

:FETCh:SPECTrum:EBWidth? (Query Only)

Returns the results of the emission bandwidth (EBW) measurement in the S/A (spectrum analysis) mode.

Syntax :FETCh:SPECTrum:EBWidth?

Arguments None

Returns <ebw>::=<Nrf> is the measured value of EBW in Hz.

Measurement Modes SANORMAL, SASGRAM, SARTIME, SAUL3G

Examples :FETCh:SPECTrum:EBWidth?
might return 30956.26 for the EBW measurement results.

Related Commands :INSTrument[:SElect]

:FETCh:SPECTrum:OBWidth? (Query Only)

Returns the results of the occupied bandwidth (OBW) measurement in the S/A (spectrum analysis) mode.

Syntax :FETCh:SPECTrum:OBWidth?

Arguments None

Returns <obw>::=<Nrf> is the measured value of OBW in Hz.

Measurement Modes SANORMAL, SASGRAM, SARTIME, SAUL3G

Examples :FETCh:SPECTrum:OBWidth?
might return 26510.163 for the OBW measurement results.

Related Commands :INSTrument[:SElect]

:FETCh:SPECTrum:SPURious? (Query Only)

Returns the results of the spurious signal measurement in the S/A (spectrum analysis) mode.

Syntax :FETCh:SPECTrum:SPURious?

Arguments None

Returns <snum>{,<dfreq>,<rdb>}

Where

<snum>::=<NR1> is the number of detected spurious emissions, max. 20

<dfreq>::=<NRf> is the detuned frequency of spurious relative to carrier in Hz.

<rdb>::=<NRf> is the spurious signal level relative to carrier in dB.

Measurement Modes SANORMAL, SASGRAM, SARTIME

Examples :FETCh:SPECTrum:SPURious?
might return 3,1.2E6,-79,2.4E6,-79.59,1E6,-80.38 for the spurious signal measurement.

Related Commands :INSTRument[:SELect]

:FETCh:TRANSient:FVTime? (Query Only)

Returns the results of the frequency versus time measurement in the Time mode (time analysis).

Syntax :FETCh:TRANSient:FVTime?

Arguments None

Returns #<Num_digit><Num_byte><Data(1)><Data(2)>...<Data(n)>

Where

<Num_digit> is the number of digits in <Num_byte>.

<Num_byte> is the number of bytes of data that follow.

<Data(n)> is the frequency data in Hz for the point n.

4-byte little endian floating-point format specified in IEEE 488.2

n: Max 512000 (= 1024 points × 500 frames)

Measurement Modes TIMTRAN

Examples :FETCh:TRANSient:FVTime?
might return #41024xxxx... (1024-byte data) for the results of the frequency versus time measurement.

Related Commands :INSTrument[:SElect]

:FETCh:TRANsient:IQVTime? (Query Only)

Returns the results of the IQ level versus time measurement in the Time (time analysis) mode.

Syntax :FETCh:TRANsient:IQVTime?

Arguments None

Returns #<Num_digit><Num_byte><Idata(1)><Qdata(1)>
<Idata(2)><Qdata2>...<Idata(n)><Qdata(n)>

Where

<Num_digit> is the number of digits in <Num_byte>.

<Num_byte> is the number of bytes of data that follow.

<Idata(n)><Qdata(n)> is the I and Q signal level data in volts for the point n.

4-byte little endian floating-point format specified in IEEE 488.2

n: Max 512000 (= 1024 points × 500 frames)

Measurement Modes TIMTRAN

Examples :FETCh:TRANsient:IQVTime?
might return #41024xxxx... (1024-byte data) for the results of the IQ level versus time measurement.

Related Commands :INSTrument[:SElect]

:FETCh:TRANSient:PVTime? (Query Only)

Returns the results of the power versus time measurement in the Time (time analysis) mode.

Syntax :FETCh:TRANSient:PVTime?

Arguments None

Returns #<Num_digit><Num_byte><Data(1)><Data(2)>...<Data(n)>

Where

<Num_digit> is the number of digits in <Num_byte>.

<Num_byte> is the number of bytes of data that follow.

<Data(n)> is the time domain power data in dBm.

4-byte little endian floating-point format specified in IEEE 488.2

n: Max 512000 (= 1024 points × 500 frames)

Measurement Modes TIMTRAN

Examples :FETCh:TRANSient:PVTime?
might return #41024xxxx... (1024-byte data) for the results of the power versus time measurement.

Related Commands :INSTrument[:SElect]

:FETCh Commands (Option)

This section describes the :FETCh commands for optional analysis software as shown in Table 2-65.

Table 2-65: :FETCh command subgroups (Option)

Command header	Function	Refer to:
Option 21 Advanced measurement suite related		
:FETCh:DDEMod	Returns the results of the digital modulation analysis.	page 2-688
:FETCh:RFID	Returns the results of the RFID analysis.	page 2-694
:FETCh:SSource	Returns the results of the signal source analysis.	page 2-704
Option 23 W-CDMA uplink analysis related		
:FETCh:AC3Gpp	Returns the results of the ACLR measurement.	page 2-713
:FETCh:UL3Gpp	Returns the results of the W-CDMA uplink analysis.	page 2-714
Option 24 GSM/EDGE analysis related		
:FETCh:GSMedge	Returns the results of the GSM/EDGE analysis.	page 2-720
Option 25 cdma2000 analysis related		
:FETCh:FLCDMA2K RLCDMA2K	Returns the results of the cdma2000 analysis.	page 2-732
Option 26 1xEV-DO analysis related		
:FETCh:FL1XEVD0 RL1XEVD0	Returns the results of the 1xEV-DO analysis.	page 2-752
Option 27 3GPP-R5 analysis related		
:FETCh:DLR5_3GPP	Returns the results of the 3GPP-R5 downlink analysis.	page 2-776
:FETCh:SADLR5_3GPP SAULR5_3GPP	Returns the results of the 3GPP-R5 spectrum analysis.	page 2-782
:FETCh:ULR5_3GPP	Returns the results of the 3GPP-R5 uplink analysis.	page 2-797
Option 28 TD-SCDMA analysis related		
:FETCh:TD_SCDMA	Returns the results of the TD-SCDMA analysis.	page 2-803
Option 29 WLAN analysis related		
:FETCh:M2WLAN	Returns the results of the IEEE802.11n MIMO (2x2) analysis.	page 2-826
:FETCh:SWLAN	Returns the results of the IEEE802.11n (nx1) analysis.	page 2-833
:FETCh:WLAN	Returns the results of the IEEE802.11a/b/g analysis.	page 2-841
Option 40 3GPP-R6 analysis related		
:FETCh:DLR6_3GPP	Returns the results of the 3GPP-R6 downlink modulation analysis.	page 2-850
:FETCh:ULR6_3GPP	Returns the results of the 3GPP-R6 uplink modulation analysis.	page 2-856

:FETCh:DDEMod Subgroup

Modulation Analysis, Option 21 Only

The :FETCh:DDEMod commands return the results of the digital modulation analysis.

Command Tree	Header	Parameter
	:FETCh	
	:DDEMod?	IQVTime FVTime CONSTe EVM AEVM PEVM MERRor AMERRor PMERRor PERRor APERRor PPERror RHO SLENgth FERRor OOFFset STABLE PVTime AMAM AMPM CCDF PDF RMSError FDEVIation

:FETCh:DDEMod? (Query Only)

Returns the results of the digital modulation analysis.

Syntax :FETCh:DDEMod? { IQVTime | FVTime | CONStE | EVM | AEVM | PEVM
| MERRor | AMERRor | PMERRor | PERRor | APERRor | PPERror | RHO
| SLENgth | FERRor | OOFFset | STABle | PVTime | AMAM | AMPM
| CCDF | PDF | RMSError | FDEVIation }

Arguments Information queried is listed below for each of the arguments:

Table 2-66: Queried information on the digital modulation analysis results

Argument	Information queried
IQVTime	IQ level versus Time measured value
FVTime	Frequency versus Time measured value (for FSK demodulation only)
CONStE	Constellation measurement results (coordinates data array of symbols)
EVM	Error Vector Magnitude (EVM) measurement results
AEVM	EVM RMS value
PEVM	EVM peak value and its symbol number
MERRor	Amplitude error
AMERRor	Amplitude error RMS value
PMERRor	Amplitude error peak value and its symbol number
PERRor	Phase error
APERRor	Phase error RMS value
PPERror	Phase error peak value and its symbol number
RHO	Value of waveform quality (ρ)
SLENgth	Number of analyzed symbols
FERRor	Frequency error
OOFFset	Origin offset value (Not available when [:SENSe]:DDEMod:FORMat is set to ASK, FSK or GFSK)
STABle	Data from symbol table
PVTime	Power versus Time (Valid when [:SENSe]:DDEMod:FORMat is set to ASK)
AMAM	AM/AM measurement results
AMPM	AM/PM measurement results
CCDF	CCDF measurement results
PDF	PDF measurement results

Table 2-66: Queried information on the digital modulation analysis results (Cont.)

Argument	Information queried
RMSError	Frequency error RMS value (Valid when [:SENSe]:DDEMod:FORMat is set to C4FM)
FDEviation	Frequency deviation (Valid when [:SENSe]:DDEMod:FORMat is set to C4FM)

Returns Returns are listed below for each of the arguments. You can select degrees or radians for the angular unit using the :UNIT:ANGLE command.

IQVTime. #<Num_digit><Num_byte><Idata(1)><Qdata(1)>
<Idata(2)><Qdata2>...<Idata(n)><Qdata(n)>

Where

<Num_digit> is the number of digits in <Num_byte>.

<Num_byte> is the number of bytes of data that follow.

<Idata(n)><Qdata(n)> is the I and Q signal level data in volts.

4-byte little endian floating-point format specified in IEEE 488.2

n: Max 512000 (= 1024 points × 500 frames)

FVTime. #<Num_digit><Num_byte><Data(1)><Data(2)>...<Data(n)>

Where

<Num_digit> is the number of digits in <Num_byte>.

<Num_byte> is the number of bytes of data that follow.

<Data(n)> is the frequency shift data in Hz for the point n.

4-byte little endian floating-point format specified in IEEE 488.2

n: Max 512000 (= 1024 points × 500 frames)

CONSte. #<Num_digit><Num_byte><Ip(1)><Qp(1)>...<Ip(n)><Qp(n)>

Where

<Num_digit> is the number of digits in <Num_byte>.

<Num_byte> is the number of bytes of data that follow.

<Ip(n)> is the sample position on the I axis in a normalized value.

<Qp(n)> is the sample position on the Q axis in a normalized value.

Both <Ip(n)> and <Qp(n)> are in the 4-byte little endian floating-point format

specified in IEEE 488.2. n: Max 512000 (= 1024 points × 500 frames)

EVM. #<Num_digit><Num_byte><Evm(1)><Evm(2)>...<Evm(n)>

Where

<Num_digit> is the number of digits in <Num_byte>.

<Num_byte> is the number of bytes of data that follow.

<Evm(n)> is the value of symbol EVM in percent (%).

4-byte little endian floating-point format specified in IEEE 488.2

n: Max 512000 (= 1024 points × 500 frames)

AEVM. <aevm>::=<NRf> is the EVM RMS value in percent (%).

PEVM. <pevm>, <symb>

Where

<pevm>::=<NRf> is the EVM peak value in percent (%).

<symb>::=<NR1> is the symbol number for the EVM peak value.

MERRor. #<Num_digit><Num_byte><Merr(1)><Merr(2)>...<Merr(n)>

Where

<Num_digit> is the number of digits in <Num_byte>.

<Num_byte> is the number of bytes of data that follow.

<Merr(n)> is the value of amplitude error of symbol in percent (%).

4-byte little endian floating-point format specified in IEEE 488.2

n: Max 512000 (= 1024 points × 500 frames)

AMERror. <amer>::=<NRf> is the amplitude error RMS value in percent (%).

PMERror. <pmer>, <symb>

Where

<pmer>::=<NRf> is the amplitude error peak value in percent (%).

<symb>::=<NR1> is the symbol number for the amplitude error peak value.

PERRor. #<Num_digit><Num_byte><Perr(1)><Perr(2)>...<Perr(n)>

Where

<Num_digit> is the number of digits in <Num_byte>.

<Num_byte> is the number of bytes of data that follow.

<Perr(n)> is the value of phase error of symbol in degrees or radians.

4-byte little endian floating-point format specified in IEEE 488.2

n: Max 512000 (= 1024 points × 500 frames)

APERror. <aper> ::= <NRf> is the phase error RMS in degrees or radians.

PPERror. <pper>, <symb>

Where

<pper> ::= <NRf> is the phase error peak value in degrees or radians.

<symb> ::= <NRf> is the symbol number for the phase error peak value.

RHO. <rho> ::= <NRf> is the measured value of waveform quality (ρ).

SLENgth. <slen> ::= <NR1> is the number of analyzed symbols.

FERRor. <ferr> ::= <NRf> is the frequency error in Hz.

OOFfset. <ooff> ::= <NRf> is the origin offset in dB.

STABle. #<Num_digit><Num_byte><Sym(1)><Sym(2)>...<Sym(n)>

Where

<Num_digit> is the number of digits in <Num_byte>.

<Num_byte> is the number of bytes of data that follow.

<Sym(n)> ::= <NR1> is the symbol data.

n: Max 512000 (= 1024 points × 500 frames)

PVTime. #<Num_digit><Num_byte><Data(1)><Data(2)>...<Data(n)>

Where

<Num_digit> is the number of digit in <Num_byte>.

<Num_byte> is the number of bytes of data that follow.

<Data(n)> is the time domain power data in dBm.

4-byte little endian floating-point format specified in IEEE 488.2.

n: Max 512000 (= 1024 points × 500 frames)

AMAM. <Comp>, <Coeff_num>{, <Coeff>}

Where

<Comp> ::= <NRf> is the 1 dB compression point in dBm.

<Coeff_num> ::= <NR1> is the number of coefficients (1 to 16).

It is equal to the value set using the [:SENSe]:DDEMod:NLINearity:COEFFi-
cient command plus 1.

<Coeff> ::= <NRf> is the coefficient value.

AMPM. <Coeff_num>{,<Coeff>}

Where

<Coeff_Num>::=<NR1> is the number of coefficients (1 to 16).

It is equal to the value set using the [:SENSE]:DDEMod:NLINearity:COEFFi-
cient command plus 1.

<Coeff>::=<NRf> is the coefficient value.

CCDF. <Mean_Power_D>,<Peak_Power_D>,<Crest_Factor_D>,
<Mean_Power_R>,<Peak_Power_R>,<Crest_Factor_R>

Where

<Mean_Power_D>::=<NRf> is the measured average power in dBm.

<Peak_Power_D>::=<NRf> is the measured peak power in dBm.

<Crest_Factor_D>::=<NRf> is the measured crest factor in dB.

<Mean_Power_R>::=<NRf> is the reference average power in dBm.

<Peak_Power_R>::=<NRf> is the reference peak power in dBm.

<Crest_Factor_R>::=<NRf> is the reference crest factor in dB.

PDF. <Mean_Power_D>,<Peak_Power_D>,<Mean_Power_R>,<Peak_Power_R>

Where

<Mean_Power_D>::=<NRf> is the measured average power in dBm.

<Peak_Power_D>::=<NRf> is the measured peak power in dBm.

<Mean_Power_R>::=<NRf> is the reference average power in dBm.

<Peak_Power_R>::=<NRf> is the reference peak power in dBm.

RMSError. <RMSError>::=<NRf> is the RMS frequency error in Hz.

FDEviation. <FDeviation>::=<NRf> is the frequency deviation in Hz.

Measurement Modes DEMDDEM

Examples :FETCh:DDEMod? IQVTime
might return #41024xxxx... (1024-byte data) for the IQ level versus time
measurement results.

Related Commands :INSTrument[:SElect], [:SENSE]:DDEMod:FORMat, :UNIT:ANGLE

:FETCh:RFID Subgroup

RFID Analysis, Option 21 Only

The :FETCh:RFID commands return the results of the RFID (Radio Frequency Identification) analysis.

Command Tree

Header

Parameter

:FETCh

:RFID?

CARRier | PODown | BPDown

| RFENvelope | BRFEvelope

| CONSte | EYE | STABle | PSTable

:ACPower?

:SPURious?

:SPECTrum

:ACPower?

:SPURious?

:FETCh:RFID? (Query Only)

Returns the results of a selected measurement in the RFID analysis.

Syntax :FETCh:RFID? { CARRier | PODown | BPODown | RFENvelope
| BRFevelope | CONSte | EYE | STABle | PSTable }

Arguments The arguments indicate the measurements as shown in Table 2-67.

Table 2-67: RFID measurement selections

Argument	Measurement
CARRier	Carrier
PODown	Power on/down (ASCII format)
BPODown	Power on/down (Binary format)
RFENvelope	RF envelope (ASCII format)
BRFevelope	RF envelope (Binary format)
CONSte	Constellation
EYE	Eye diagram
STABle	Symbol table
PSTable	Preamble of the symbol table

Returns Returns are listed below for each of the arguments:

CARRier. <Cfreq>, <Obw>, <Ebw>, <Max_EIRP>

Where

<Cfreq>::=<NRf> is the carrier frequency in Hz.

<Obw>::=<NRf> is the occupied bandwidth in Hz.

<Ebw>::=<NRf> is the emission bandwidth in Hz.

<Max_EIRP>::=<NRf> is the maximum EIRP in dBm.

PODown. <Srate>, <Estrate>, <Count>{, <Index>, <Rise/Fall>, <Time>, <Settling>, <Over>, <Under>, <Offset>}

Where

<Srate>::=<NRf> is the actual sample rate in Hz.

<Estrate>::=<NRf> is the effective sample rate in Hz.

<Count>::=<NR1> is the count of data sets that follow (0 to 64).

<Index>::=<NR1> is the index number.

<Rise/Fall>::=<NR1> indicates rise (1) or fall (0) time.

<Time>::=<NRf> is the rise or fall time in seconds.
<Settling>::=<NRf> is the settling time in seconds.
<Over>::=<NRf> is the overshoot in percent (%).
<Under>::=<NRf> is the undershoot in percent (%).
<Offset>::=<NRf> is the average level when the signal is off (%).

If <Count> is more than 64, only -1000 is returned as invalid data.

BPODown. #<Num_digit><Num_byte><Srate><Esrate><Count>{<Index>
<Rise/Fall><Time><Settling><Over><Under><Offset>}

Where

<Num_digit> is the number of digits in <Num_byte>.

<Num_byte> is the number of bytes of data that follow.

The following data are the 4-byte little endian floating-point format:

<Srate> is the actual sample rate in Hz.

<Esrate> is the effective sample rate in Hz.

<Count> is the count of data sets that follow (0 to 20000).

<Index> is the index number.

<Rise/Fall> indicates rise (1) or fall (0) time.

<Time> is the rise or fall time in seconds.

<Settling> is the settling time in seconds.

<Over> is the overshoot in percent (%).

<Under> is the undershoot in percent (%).

<Offset> is the average level when the signal is off (%).

If <Count> is more than 20000, only -1000 is returned as invalid data.

RFENvelope. <Srate>,<Esrate>,<Count>{,<Index>,
<On_Width>,<Off_Width>,<Period>,<Duty>,<On_Ripple>,<Off_Ripple>,
<Slope_1_Rise/Fall>,<Slope_1>,<Slope_2_Rise/Fall>,<Slope_2>,
<Slope_3_Rise/Fall>,<Slope_3>}

Where

<Srate>::=<NRf> is the sample rate in Hz.

<Esrate>::=<NRf> is the effective sample rate in Hz.

<Count>::=<NR1> is the count of data sets that follow (0 to 64).

<Index>::=<NR1> is the index number.

<On_Width>::=<NRf> is the on-width time in seconds.

<Off_Width>::=<NRf> is the off-width time in seconds.

<Period>::=<NRf> is the period (on-width + off-width) in seconds.

<Duty>::=<NRf> is the duty cycle in percent (%).

<On_Ripple>::=<NRf> is the on ripple in percent (%).

<Off_Ripple>::=<NRf> is the off ripple in percent (%).

<Slope_1_Rise/Fall>::=<NR1> indicates rise (1) or fall (0) for Slope 1.

<Slope_1>::=<NRf> is the Slope 1 rise/fall time in seconds.

<Slope_2_Rise/Fall>::=<NR1> indicates rise (1) or fall (0) for Slope 2.
 <Slope_2>::=<NRf> is the Slope 2 rise/fall time in seconds.
 <Slope_3_Rise/Fall>::=<NR1> indicates rise (1) or fall (0) for Slope 3.
 <Slope_3>::=<NRf> is the Slope 3 rise/fall time in seconds.

If <Count> is more than 64, only -1000 is returned as invalid data.

BRFenvelope. #<Num_digit><Num_byte><Srate><Esrate><Count>{<Index>
 <On_Width><Off_Width><Period><Duty><On_Ripple><Off_Ripple>
 <Slope_1_Rise/Fall><Slope_1><Slope_2_Rise/Fall><Slope_2>
 <Slope_3_Rise/Fall><Slope_3>}

Where

<Num_digit> is the number of digits in <Num_byte>.

<Num_byte> is the number of bytes of data that follow.

The following data are the 4-byte little endian floating-point format:

<Srate> is the sample rate in Hz.

<Esrate> is the effective sample rate in Hz.

<Count> is the count of data sets that follow (0 to 65536).

<Index> is the index number.

<On_Width> is the on-width time in seconds.

<Off_Width> is the off-width time in seconds.

<Period> is the period (on-width + off-width) in seconds.

<Duty> is the duty cycle in percent (%).

<On_Ripple> is the on ripple in percent (%).

<Off_Ripple> is the off ripple in percent (%).

<Slope_1_Rise/Fall> indicates rise (1) or fall (0) for Slope 1.

<Slope_1> is the Slope 1 rise/fall time in seconds.

<Slope_2_Rise/Fall> indicates rise (1) or fall (0) for Slope 2.

<Slope_2> is the Slope 2 rise/fall time in seconds.

<Slope_3_Rise/Fall> indicates rise (1) or fall (0) for Slope 3.

<Slope_3> is the Slope 3 rise/fall time in seconds.

If <Count> is more than 65536, only -1000 is returned as invalid data.

CONStE and EYE .

NOTE. The constellation measurement is invalid when [:SENSe]:RFID:MODulation:STANdard is set to "C0G1" or "C1G1".

When the decoding format is other than PIE:

<Mdepth>,<Mindex>,<Ferror>,<Abrate>,<Ebrate>,<Esbrate>

Where

<Mdepth>::=<NRf> is the modulation depth in percent (%).

<Mindex>::=<NRf> is the modulation index in percent (%).

<Ferror>::=<NRf> is the frequency error in Hz.
 <Abrate>::=<NR1> is the auto bit rate setting. 0: Off, 1: On.
 <Ebrate>::=<NRf> is the estimated bit rate in bps.
 <Esbrate>::=<NRf> is the estimated symbol rate in symbols/s.

When the decoding format is PIE:

<Mdepth>,<Mindex>,<Ferror>,<Atari>,<Etdata0_S>,<Etdata0_T>,
 <Etdata1_S>,<Etdata1_T>

Where

<Mdepth>::=<NRf> is the modulation depth in percent (%).
 <Mindex>::=<NRf> is the modulation index in percent (%).
 <Ferror>::=<NRf> is the frequency error in Hz
 <Atari>::=<NR1> is the auto tari setting. 0: Off, 1: On.
 <Etdata0_S>::=<NRf> is the estimated tari data-0 in seconds.
 <Etdata0_T>::=<NRf> is the estimated tari data-0 (Tari).
 <Etdata1_S>::=<NRf> is the estimated tari data-1 in seconds.
 <Etdata1_T>::=<NRf> is the estimated tari data-1 (Tari).

When the modulation type is Subcarrier BPSK:

<Mdepth>,<Mindex>,<Ferror>,<Abrate>,<Ebrate>,<Esbrate>,
 <Sjitter>,<Foffset>

Where

<Mdepth>::=<NRf> is the modulation depth in percent (%).
 <Mindex>::=<NRf> is the modulation index in percent (%).
 <Ferror>::=<NRf> is the frequency error in Hz.
 <Abrate>::=<NR1> is the auto bit rate setting. 0: Off, 1: On.
 <Ebrate>::=<NRf> is the estimated bit rate in bps.
 <Esbrate>::=<NRf> is the estimated symbol rate in symbols/s.
 <Sjitter>::=<NRf> is the RMS subcarrier jitter in seconds.
 <Foffset>::=<NRf> is the frequency offset in Hz.

STABLE. #<Num_digit><Num_byte><Sym(1)><Sym(2)>...<Sym(n)>

Where

<Num_digit> is the number of digits in <Num_byte>.
 <Num_byte> is the number of bytes of data that follow.
 <Sym(n)>::=<NR1> is the symbol data.
 4-byte little endian floating-point format specified in IEEE 488.2

Table 2-68: Symbol value definition

Value on screen	Value on GPIB	Definition
0	0	0
1	1	1
X	-1	Don't care

Table 2-68: Symbol value definition (Cont.)

Value on screen	Value on GPIB	Definition
P	-2	Preamble
S	-3	Frame Sync
N	-4	Null

PSTable. <Len> ::= <NR1> is the preamble length of the symbol table.

Measurement Modes DEMRFID

Examples :FETCh:RFID? CARRier
might return 985.891768E+6,45.383E+3,104.601,30 for the carrier measurement result.

Related Commands :INSTrument[:SElect], [:SENSe]:RFID:MODulation:STANdard

:FETCh:RFID:ACPower? (Query Only)

Returns the results of the ACPR (Adjacent Channel leakage Power Ratio) measurement in the RFID analysis.

Syntax :FETCh:RFID:ACPower?

Arguments None

Returns <Count>{,<Ofrequency>,<Upper>,<Lower>}

Where

<Count>::=<NR1> is the count of data sets that follow (0 to 25).

<Ofrequency>::=<NRf> is the offseet frequency in Hz.

<Upper>::=<NRf> is the ACPR for the nth upper adjacent channel in dBc.

<Lower>::=<NRf> is the ACPR for the nth lower adjacent channel in dBc.

Measurement Modes DEMRFID

Examples :FETCh:RFID:ACPower?
might return 2,500E+3,-38.45,-38.43,1E+6,-44.14,-44.11 for the ACPR measurement result.

Related Commands :INSTRument[:SElect]

:FETCh:RFID:SPURious? (Query Only)

Returns the results of the spurious signal measurement in the RFID analysis.

Syntax :FETCh:RFID:SPURious?

Arguments None

Returns <Snum>{,<Dfreq>,<Rdbc>}

Where

<Snum>::=<NR1> is the number of detected spurious emissions. Max. 20.

<Dfreq>::=<NRf> is the detuned frequency of spurious relative to carrier in Hz.

<Rdbc>::=<NRf> is the spurious signal level relative to carrier in dBc.

Measurement Modes DEMRFID

Examples :FETCh:RFID:SPURious?
might return 2,-468.75E+3,-45.62,787.5E+3,-49.88 for the spurious measurement result.

Related Commands :INSTrument[:SElect]

:FETCh:RFID:SPECTrum:ACPower? (Query Only)

Returns spectrum waveform data of the ACPR (Adjacent Channel leakage Power Ratio) measurement in the RFID analysis.

Syntax :FETCh:RFID:SPECTrum:ACPower?

Arguments None

Returns #<Num_digit><Num_byte><Data(1)><Data(2)>...<Data(n)>

Where

<Num_digit> is the number of digits in <Num_byte>.

<Num_byte> is the number of bytes of data that follow.

<Data(n)> is the amplitude of the spectrum in dBm.

4-byte little endian floating-point format specified in IEEE 488.2.

n: Max 240001

Measurement Modes DEMRFID

Examples :FETCh:RFID:SPECTrum:ACPower?
might return #43200xxxx... (3200-byte data) for the spectrum data.

Related Commands :INSTRument[:SElect]

:FETCh:RFID:SPECTrum:SPURious? (Query Only)

Returns spectrum waveform data of the spurious measurement in the RFID analysis.

Syntax :FETCh:RFID:SPECTrum:SPURious?

Arguments None

Returns #<Num_digit><Num_byte><Data(1)><Data(2)>...<Data(n)>

Where

<Num_digit> is the number of digits in <Num_byte>.

<Num_byte> is the number of bytes of data that follow.

<Data(n)> is the amplitude of the spectrum in dBm.

4-byte little endian floating-point format specified in IEEE 488.2.

n: Max 240001

Measurement Modes DEMRFID

Examples :FETCh:RFID:SPECTrum:SPURious?
might return #43200xxxx... (3200-byte data) for the spectrum data.

Related Commands :INSTrument[:SElect]

:FETCh:SSource Subgroup

Signal Source Analysis, Option 21 Only

The :FETCh:SSource commands return the results of the signal source analysis.

Command Tree	Header	Parameter
	:FETCh	
	:SSource?	PNOise SPURious RTPNoise RTSPurious FVTime
	:CNVFrequency?	
	:CNVTime?	
	:IPNVtime?	
	:IPNVtime?	
	:RJVTime?	
	:SPECTrum?	
	:TRANsient	
	:FVTime?	

:FETCh:SSource? (Query Only)

Returns the result of the selected measurement in the signal source analysis.

Syntax :FETCh:SSource? { PNOise | SPURious | RTPNoise | RTSPurious
| FVTime }

Arguments The arguments indicate the measurements as shown in Table 2-69.

Table 2-69: Signal source analysis

Argument	Measurement
PNOise	Phase noise
SPURious	Spurious
RTPNoise	Real-time phase noise
RTSPurious	Real-time spurious
FVTime	Frequency versus Time

Returns Returns are listed below for each of the arguments:

PNOise. <Cfreq>, <Cpower>, <IP_Noise>, <Rj>, <Max_Pj>

Where

<Cfreq>::=<NRf> is the carrier frequency in Hz.

<Cpower>::=<NRf> is the channel power in dBm.

<IP_Noise>::=<NRf> is the integrated phase noise in radians or degrees

<Rj>::=<NRf> is the random jitter in seconds.

<Max_Pj>::=<NRf> is the maximum periodic jitter in seconds.

SPURious. <snum>{ , <dfreq>, <rdb> }

Where

<snum>::=<NR1> is the number of detected spurious signals (max. 20)

<dfreq>::=<NRf> is the detuned frequency of spurious relative to carrier in Hz.

<rdb>::=<NRf> is the spurious signal level relative to carrier in dBc.

RTPNoise. <Cfreq>, <Cpower>, <IP_Noise>, <Rj>, <Max_Pj>, <Jstime>, <Jsstart>, <Jsstop>, <PNstime>, <PNstart>, <PNSstop>

Where

<Cfreq>::=<NRf> is the carrier frequency in Hz.
<Cpower>::=<NRf> is the channel power in dBm.
<IP_Noise>::=<NRf> is the integrated phase noise in radians or degrees.
<Rj>::=<NRf> is the random jitter in seconds.
<Max_Pj>::=<NRf> is the maximum periodic jitter in seconds.
<Jstime>::=<NRf> is the jitter settling time in seconds.
<Jsstart>::=<NRf> is the jitter settling time start in seconds.
<Jsstop>::=<NRf> is the jitter settling time stop in seconds.
<PNstime>::=<NRf> is the phase noise settling time in seconds.
<PNsstart>::=<NRf> is the phase noise settling time start in seconds.
<PNSstop>::=<NRf> is the phase noise settling time stop in seconds.

RTSPurious. <Cfreq>, <Cpower>, <Snum>{, <Dfreq>, <Rdbc>}

Where

<Cfreq>::=<NRf> is the carrier frequency in Hz.
<Cpower>::=<NRf> is the channel power in dBm.
<Snum>::=<NR1> is the number of detected spurious signals (max. 20).
<Dfreq>::=<NRf> is the detuned frequency of spurious relative to carrier in Hz.
<Rdbc>::=<NRf> is the spurious signal level relative to carrier in dBc.

FVTime. <Fstime>, <Fsstart>, <Fsstop>, <TFstime>, <Tfsstart>, <Tfsstop>

Where

<Fstime>::=<NRf> is the frequency settling time.
<Fsstart>::=<NRf> is the frequency settling time start.
<Fsstop>::=<NRf> is the frequency settling time stop.
<TFstime>::=<NRf> is the frequency settling time from trigger.
<Tfsstart>::=<NRf> is the frequency settling time start from trigger.
<Tfsstop>::=<NRf> is the frequency settling time stop from trigger
Unit: All in seconds.

Measurement Modes

TIMSSOURCE

Examples

:FETCh:SSource? PNOise
might return 2.0E+9, -21.430, 12.432E-12, 8.95, 217.725E-12 for the phase noise measurement result.

:FETCh:SSource:CNVFrequency? (Query Only)

Returns measurement data of the C/N versus offset frequency in the signal source analysis.

This command is valid when [:SENSe]:SSource:MEASurement is set to PNOise or RTPNoise. It is also valid when [:SENSe]:SSource:MEASurement is set to RTSPurious and :DISPlay:SSource:SVIew:FORMat is CNVFrequency.

Syntax :FETCh:SSource:CNVFrequency? { MAIN | SUB }

Arguments MAIN selects Trace 1 (displayed in yellow on screen).
SUB selects Trace 2 (displayed in green on screen).

Returns #<Num_digit><Num_byte><Freq(1)><C/N(1)><Freq(2)><C/N(2)>...
<Freq(n)><C/N(n)>

Where

<Num_digit> is the number of digits in <Num_byte>.

<Num_byte> is the number of bytes of data that follow.

<Freq(n)> is the offset frequency in Hz.

<C/N(n)> is the C/N in dBc/Hz.

4-byte little endian floating-point format specified in IEEE 488.2.

n: Max 5000

Measurement Modes TIMSSOURCE

Examples :FETCh:SSource:CNVFrequency? MAIN
might return #43200xxxx... (3200-byte data) for the Trace 1 data of the C/N versus offset frequency measurement.

Related Commands :DISPlay:SSource:SVIew:FORMat, [:SENSe]:SSource:MEASurement

:FETCh:SSource:CNVTime? (Query Only)

Returns waveform data of the C/N versus time in the signal source analysis.

This command is valid when [:SENSe]:SSource:MEASurement is set to RTPNoise and :DISPlay:SSource:SVIew:FORMat is CNVTime.

Syntax :FETCh:SSource:CNVTime?

Arguments None

Returns #<Num_digit><Num_byte><Data(1)><Data(2)>...<Data(n)>

Where

<Num_digit> is the number of digits in <Num_byte>.

<Num_byte> is the number of bytes of data that follow.

<Data(n)> is the C/N value in dBc/Hz.

4-byte little endian floating-point format specified in IEEE 488.2.

Measurement Modes TIMSSOURCE

Examples :FETCh:SSource:CNVTime?
might return #43200xxxx... (3200-byte data) for waveform data of the C/N versus time.

Related Commands :DISPlay:SSource:SVIew:FORMat, [:SENSe]:SSource:MEASurement

:FETCh:SSource:IPNVtime? (Query Only)

Returns waveform data of the integrated phase noise versus time in the signal source analysis.

This command is valid when [:SENSe]:SSource:MEASurement is set to RTPNoise and :DISPlay:SSource:SVIew:FORMat is IPNVtime.

Syntax :FETCh:SSource:IPNVtime?

Arguments None

Returns #<Num_digit><Num_byte><Data(1)><Data(2)>...<Data(n)>

Where

<Num_digit> is the number of digits in <Num_byte>.

<Num_byte> is the number of bytes of data that follow.

<Data(n)> is the phase in radians or degrees.

4-byte little endian floating-point format specified in IEEE 488.2.

Measurement Modes TIMSSOURCE

Examples :FETCh:SSource:IPNVtime?
might return #43200xxxx... (3200-byte data) for waveform data of the integrated phase noise versus time.

Related Commands :DISPlay:SSource:SVIew:FORMat, [:SENSe]:SSource:MEASurement

:FETCh:SSource:RJVTime? (Query Only)

Returns waveform data of the random jitter versus time in the signal source analysis.

This command is valid when [:SENSe]:SSource:MEASurement is set to RTPNoise and :DISPlay:SSource:SView:FORMat is RJVTime.

Syntax :FETCh:SSource:RJVTime?

Arguments None

Returns #<Num_digit><Num_byte><Data(1)><Data(2)>...<Data(n)>

Where

<Num_digit> is the number of digits in <Num_byte>.

<Num_byte> is the number of bytes of data that follow.

<Data(n)> is the jitter in seconds.

4-byte little endian floating-point format specified in IEEE 488.2.

Measurement Modes TIMSSOURCE

Examples :FETCh:SSource:RJVTime?
might return #43200xxxx... (3200-byte data) for waveform data of the random jitter versus time.

Related Commands :DISPlay:SSource:SView:FORMat, [:SENSe]:SSource:MEASurement

:FETCh:SSource:SPECTrum? (Query Only)

Returns spectrum waveform data of the frequency domain measurement in the signal source analysis.

This commands is valid when [:SENSe]:SSource:MEASurement is set to PNOise, SPURious, or RTSPurious.

Syntax :FETCh:SSource:SPECTrum?

Arguments None

Returns #<Num_digit><Num_byte><Data(1)><Data(2)>...<Data(n)>

Where

<Num_digit> is the number of digits in <Num_byte>.

<Num_byte> is the number of bytes of data that follow.

<Data(n)> is the amplitude of the spectrum in dBm.

4-byte little endian floating-point format specified in IEEE 488.2.

n: Max 240001

Measurement Modes TIMSSOURCE

Examples :FETCh:SSource:SPECTrum?
might return #43200xxxx... (3200-byte data) for the spectrum data.

Related Commands [:SENSe]:SSource:MEASurement

:FETCh:SSource:TRANSient:FVTime? (Query Only)

Returns the frequency versus time measurement results in the signal source analysis.

Syntax :FETCh:SSource:TRANSient:FVTime?

Arguments None

Returns #<Num_digit><Num_byte><Data(1)><Data(2)>...<Data(n)>

Where

<Num_digit> is the number of digits in <Num_byte>.

<Num_byte> is the number of bytes of data that follow.

<Data(n)> is the frequency deviation value in Hz on the time axis.

4-byte little endian floating-point format specified in IEEE 488.2.

n: Max 512000 (1024 points × 500 frames)

Measurement Modes TIMSSOURCE

Examples :FETCh:SSource:TRANSient:FVTime?
might return #43200xxxx... (3200-byte data) for the frequency versus time measurement results.

:FETCh:AC3Gpp Subgroup**W-CDMA Analysis, Option 23 Only**

The :FETCh:AC3Gpp commands return the results of the W-CDMA ACLR measurement.

Command Tree	Header	Parameter
	:FETCh	
	:AC3Gpp	
	:ACLR?	

:FETCh:AC3Gpp:ACLR? (Query Only)

Fetches the measurement results of the W-CDMA ACLR (Adjacent Channel Leakage Power Ratio) analysis.

Syntax :FETCh:AC3Gpp:ACLR?

Arguments None

Returns <chpower>,<ac1rm1>,<ac1rp1>,<ac1rm2>,<ac1rp2>

Where

<chpower>::=<NRf> is the channel power measured value in dBm.

<ac1rm1>::=<NRf> is the first lower adjacent channel ACLR in dB.

<ac1rp1>::=<NRf> is the first upper adjacent channel ACLR in dB.

<ac1rm2>::=<NRf> is the second lower adjacent channel ACLR in dB.

<ac1rp2>::=<NRf> is the second upper adjacent channel ACLR in dB.

Measurement Modes SAUL3G

Examples :FETCh:AC3Gpp:ACLR?
might return -1.081,-68.420,-68.229,-74.506,-74.462 for the W-CDMA ACLR measurement results.

Related Commands :INSTrument[:SElect]

:FETCh:UL3Gpp Subgroup

W-CDMA Analysis, Option 23 Only

The :FETCh:UL3Gpp commands return the results of the W-CDMA uplink analysis.

Command Tree	Header	Parameter
	:FETCh	
	:UL3Gpp?	CSHortcode CSYMBOL CTSLOT SCONSTE EVM AEVM PEVM MERROR AMERROR PMERROR PERROR APERROR PPEROR RHO FERROR OOFFSET STABLE TSNUMBER SIGNATURE PREAMBLE PCDE CEVM CMERROR CPEROR CRHO COOF

:FETCh:UL3Gpp? (Query Only)

Fetches the W-CDMA uplink analysis measurement results.

Syntax :FETCh:DL3Gpp? { CSHortcode | CSYMBOL | CTSLOT | SCONSTE | EVM
| AEVM | PEVM | MERROR | AMERROR | PMERROR | PERROR | APERROR
| PPEROR | RHO | FERROR | OOFFSET | STABLE | TSNUMBER
| SIGNATURE | PREAMBLE | TLENGTH | PCDE | CEVM | CMERROR
| CPEROR | CRHO | COOF }

Arguments Information queried is listed below for each of the arguments:

Table 2-70: Queried information on the W-CDMA uplink analysis results

Argument	Information queried
CSHortcode	Power of each short code for the specified TS
CSYMBOL	Each symbol power of the specified TS/SC
CTSLot	Power of each time slot for the specified SC
SCONste	Symbol position data for the specified TS/SC
EVM	Measurement results of error vector magnitude for the specified TS/SC
AEVM	RMS value of EVM for the specified TS/SC
PEVM	Peak value of EVM for the specified TS/SC and its symbol number
MERRor	Amplitude error for the specified TS/SC
AMERRor	RMS value of amplitude error for the specified TS/SC
PMERRor	Peak amplitude error for the specified TS/SC and its symbol number
PERRor	Phase error for the specified TS/SC
APERror	RMS value of phase error for the specified TS/SC
PPERror	Peak phase error for the specified TS/SC and its symbol number
RHO	Value of waveform quality (ρ) for the specified TS/SC
FERRor	Frequency error for the specified TS
OOFFSET	Value of origin offset for the specified TS/SC
STABLE	Data from symbol table for the specified TS/SC
TSNUMBER	Slot number in radio frame for the specified TS
SIGNature	Signature for the specified TS
PREAMble	Preamble length for the specified TS
TLENgth	Number of analyzed TSs
PCDE	PCDE (Peak Code Domain Error) for the specified TS, and the SC number

Table 2- 70: Queried information on the W-CDMA uplink analysis results (Cont.)

Argument	Information queried
CEVM	RMS and peak values of chip EVM for the specified TS
CMERror	RMS and peak values of chip amplitude error for the specified TS
CPError	RMS and peak values of chip phase error for the specified TS
CRHO	Chip waveform quality (Q) for the specified TS
COOF	Chip origin offset for the specified TS

* **TS: Time slot; SC: Short code**

To specify the time slot, use the :DISPlay:UL3Gpp:AVIew:TSLot command.

To specify the short code, use the :DISPlay:UL3Gpp:AVIew:SHORtcode command.

Returns Returns are listed below for each of the arguments:

CSHortcode. #<Num_digit><Num_byte><Cpwr(1)><Cpwr(2)>...<Cpwr(n)>

Where

<Num_digit> is the number of digits in <Num_byte>.

<Num_byte> is the number of bytes of data that follow.

<Cpwr(n)> is the relative or absolute power value for each short code in dB or dBm. 4-byte little endian floating-point format specified in IEEE 488.2.

n: Max 512

CSYMBOL. #<Num_digit><Num_byte><Cpwr(1)><Cpwr(2)>...<Cpwr(n)>

Where

<Num_digit> is the number of digits in <Num_byte>

<Num_byte> is the number of bytes of data that follow

<Cpwr(n)> is the relative or absolute power value for each symbol in dB or dBm. 4-byte little endian floating-point format specified in IEEE 488.2.

n: Max 640

CTSLot. #<Num_digit><Num_byte><Cpwr(1)><Cpwr(2)>...<Cpwr(n)>

Where

<Num_digit> is the number of digits in <Num_byte>.

<Num_byte> is the number of bytes of data that follow.

<Cpwr(n)> is the relative or absolute power value for each time slot in dB or dBm. 4-byte little endian floating-point format specified in IEEE 488.2.

n: Max 16000

SCONste. #<Num_digit><Num_byte><Ip(1)><Qp(1)>...<Ip(n)><Qp(n)>

Where

<Num_digit> is the number of digits in <Num_byte>.

<Num_byte> is the number of bytes of data that follow.

<Ip(n)> is the symbol position on the I axis in volts.

<Qp(n)> is the symbol position on the Q axis in volts.

Both <Ip(n)> and <Qp(n)> are in the 4-byte little endian floating-point format specified in IEEE 488.2. n: Max 640

EVM. #<Num_digit><Num_byte><Evm(1)><Evm(2)>...<Evm(n)>

Where

<Num_digit> is the number of digits in <Num_byte>.

<Num_byte> is the number of bytes of data that follow.

<Evm(n)> is the value of EVM of symbol in percent (%).

4-byte little endian floating-point format specified in IEEE 488.2

n: Max 640

AEVM. <aevm>::=<NRf> is the EVM RMS value in percent (%).

PEVM. <pevm>,<symb>

Where

<pevm>::=<NRf> is the EVM peak value in percent (%).

<symb>::=<NR1> is the symbol number for the EVM peak value.

MERRor. #<Num_digit><Num_byte><Merr(1)><Merr(2)>...<Merr(n)>

Where

<Num_digit> is the number of digits in <Num_byte>.

<Num_byte> is the number of bytes of data that follow.

<Merr(n)> is the value of amplitude error of symbol in percent (%).

4-byte little endian floating-point format specified in IEEE 488.2

n: Max 640

AMERror. <amer>::=<NRf> is the amplitude error RMS value in percent (%).

PMERror. <pmer>,<symb>

Where

<pmer>::=<NRf> is the amplitude error peak value in percent (%).

<symb>::=<NR1> is the symbol number of the amplitude error peak value.

PERRor. #<Num_digit><Num_byte><Perr(1)><Perr(2)>...<Perr(n)>

Where

<Num_digit> is the number of digits in <Num_byte>.

<Num_byte> is the number of bytes of data that follow.

<Perr(n)> is the value of phase error of symbol in degrees.

4-byte little endian floating-point format specified in IEEE 488.2

n: Max 640

APERro. <pmer>::=<NRf> is the phase error RMS value in degrees.

PPERror. <pmer>,<symb>

Where

<pmer>::=<NRf> is the phase error peak value in degrees.

<symb>::=<NRf> is the symbol number for the phase error peak value.

RHO. <rho>::=<NRf> is the measured value of waveform quality.

FERRor. <ferr>::=<NRf> is the measured value of frequency error in Hz.

OOFFSET. <ooff>::=<NRf> is the measured value of origin offset in dB.

STABLE. #<Num_digit><Num_byte><Sym(1)><Sym(2)>...<Sym(n)>

Where

<Num_digit> is the number of digits in <Num_byte>.

<Num_byte> is the number of bytes of data that follow.

<Sym(n)> is the symbol data. n: Max 640

TSNumber. <tshum>::=<NR1> is the slot number in radio frame.

SIGNature. <sign>::=<NR1> is the signature number.

PREamble. <prea>::=<NR1> is the preamble length.

TLENgth. <tlen>::=<NR1> is the number of analyzed time slots.

PCDE. <pcde>, <scod>

Where

<pcde>::=<NRf> is the PCDE (Peak Code Domain Error) value in dB

<scod>::=<NRf> is the short code number for the PCDE

CEVM. <cevma>, <cevmp>

Where

<cevma>::=<NRf> is the RMS value of chip EVM in percent (%)

<cevmp>::=<NRf> is the peak value of chip EVM in percent (%)

CMEError. <cmera>, <cmerp>

Where

<cmera>::=<NRf> is the RMS value of chip amplitude error in percent (%)

<cmerp>::=<NRf> is the peak value of chip amplitude error in percent (%)

CPERror. <cpera>, <cperp>

Where

<cpera>::=<NRf> is the RMS value of chip EVM in percent (%)

<cperp>::=<NRf> is the peak value of chip EVM in percent (%)

CRHO. <crho>::=<NRf> is the chip waveform quality (Q)

COOF. <coof>::=<NRf> is the chip origin offset in dB

Measurement Modes DEMUL3G

Examples :FETCh:UL3Gpp? CSHortcode
might return #3512xxxx... (512-byte data) for the power measurement results for each short code.

Related Commands :DISPlay:UL3Gpp:AVIew:SHORtcode, :DISPlay:UL3Gpp:AVIew:TSLot,
:INSTrument[:SELEct]

:FETCh:GSMedge Subgroup

GSM/EDGE Analysis, Option 24 Only

The :FETCh:GSMedge commands return the results of the GSM/EDGE analysis.

Command Tree	Header	Parameter
	:FETCh	
	:GSMedge	
	:MACCuracy?	
	:MCPower?	
	:MODulation?	
	:PVTime?	
	:SPECTrum	
	:MODulation?	
	:SWITching?	
	:SPURious?	
	:SWITching?	
	:TAMPLitude	
	:MCPower?	
	:PVTime?	
	:TSCode?	

:FETCh:GSMedge:MACCuracy? (Query Only)

Fetches the results of the GSM/EDGE modulation accuracy measurement for the burst specified using the [:SENSE]:GSMedge:BURSt:INDex command.

Syntax :FETCh:GSMedge:MACCuracy?

Arguments None

Returns <pass_fail>,<phase_error>,<peak_phase_error>,<evm>,<evm95>,<peak_evm>,<freq_error>,<o_off>

Where

<pass_fail>::=<NR1> = 0 represents Fail; = 1 represents Pass.

<phase_error>::=<NRf> is the phase error in degrees.

<peak_phase_error>::=<NRf> is the peak phase error in degrees.

<evm>::=<NRf> is the EVM (Error Vector Magnitude) in percent (%).

<evm95>::=<NRf> is the EVM 95% tile in percent (%).

<peak_evm>::=<NRf> is the peak EVM in percent (%).

<freq_error>::=<NRf> is the frequency error in Hz.

<o_off>::=<NRf> is the origin offset in dB.

<pass_fail> returns 1 (one) when the test is disabled.

Measurement Modes DEMGSMEDGE

Examples :FETCh:GSMedge:MACCuracy?
might return 1,0.47,0.86,0.93,0.75,2.15,4.209,-64.31 for the modulation accuracy measurement results.

Related Commands :INSTrument[:SElect], [:SENSE]:GSMedge:BURSt:INDex

:FETCh:GSMedge:MCPower? (Query Only)

Fetches the results of the GSM/EDGE mean carrier power measurement for the burst specified using the [:SENSE]:GSMedge:BURSt:INDEX command.

Syntax :FETCh:GSMedge:MCPower?

Arguments None

Returns <mean_power>,<max_power>,<max_bi>,<min_power>,<min_bi>

Where

<mean_power>::=<NRf> is the mean power value in dBm.

<max_power>::=<NRf> is the maximum power value in dBm.

<max_bi>::=<NR1> is the burst index for the maximum power.

<min_power>::=<NRf> is the minimum power value in dBm.

<min_bi>::=<NR1> is the burst index for the minimum power.

Measurement Modes DEMGSMEDGE

Examples :FETCh:GSMedge:MCPower?
might return 68.081,72.4203,-3,58.229,-7 as the mean carrier power measurement results.

Related Commands :INSTrument[:SELEct], [:SENSE]:GSMedge:BURSt:INDEX

:FETCh:GSMedge:MODulation? (Query Only)

Queries the pass/fail result of the GSM/EDGE modulation spectrum measurement for the standard specified using the [:SENSE]:GSMedge:STANdard commands.

Syntax :FETCh:GSMedge:MODulation?

Arguments None

Returns <NR1> = 0 indicates Fail.
<NR1> = 1 indicates Pass.

Measurement Modes DEMGSMEDGE

Examples :FETCh:GSMedge:MODulation?
might return 1, indicating that the modulation spectrum measurement has passed.

Related Commands :INSTrument[:SElect], [:SENSE]:GSMedge:STANdard

:FETCh:GSMedge:PVTime? (Query Only)

Queries the pass/fail result of the GSM/EDGE power versus time measurement for the burst specified using the [:SENSe]:GSMedge:BURSt:INDEx command.

Syntax :FETCh:GSMedge:PVTime?

Arguments None

Returns <NR1> = 0 indicates Fail.
<NR1> = 1 indicates Pass.

Measurement Modes DEMGSMEDGE

Examples :FETCh:GSMedge:PVTime?
might return 1, indicating that the power versus time measurement has passed.

Related Commands :INSTrument[:SELEct], [:SENSe]:GSMedge:BURSt:INDEx

:FETCh:GSMedge:SPECTrum:MODulation? (Query Only)

Returns waveform data of the GSM/EDGE modulation spectrum measurement for the burst specified using the [:SENSe]:GSMedge:BURSt:INDeX command.

Syntax :FETCh:GSMedge:SPECTrum:MODulation?

Returns #<Num_digit><Num_byte><Data(1)><Data(2)>...<Data(n)>

Where

<Num_digit> is the number of digits in <Num_byte>.

<Num_byte> is the number of bytes of data that follow.

<Data(n)> is the modulation spectrum power data in dBm.

4-byte little endian floating-point format specified in IEEE 488.2

n: Max 240001

Measurement Modes DEMGSMEDGE

Examples :FETCh:GSMedge:SPECTrum:MODulation?
might return #510240xxx... (10240-byte data) as the results of the modulation spectrum measurement.

Related Commands :INSTrument[:SElect], [:SENSe]:GSMedge:BURSt:INDeX

:FETCh:GSMedge:SPECTrum:SWITching? (Query Only)

Returns waveform data of the GSM/EDGE switching spectrum measurement for the burst specified using the [:SENSe]:GSMedge:BURSt:INDEx command.

Syntax :FETCh:GSMedge:SPECTrum:SWITching?

Returns #<Num_digit><Num_byte><Data(1)><Data(2)>...<Data(n)>

Where

<Num_digit> is the number of digits in <Num_byte>.

<Num_byte> is the number of bytes of data that follow.

<Data(n)> is the switching spectrum power data in dBm.

4-byte little endian floating-point format specified in IEEE 488.2

n: Max 240001

Measurement Modes DEMGSMEDGE

Examples :FETCh:GSMedge:SPECTrum:SWITching?
might return #510240xxx... (10240-byte data) as the results of the switching spectrum measurement.

Related Commands :INSTRument[:SELEct], [:SENSe]:GSMedge:BURSt:INDEx

:FETCh:GSMedge:SPURious? (Query Only)

Fetches the results of the GSM/EDGE spurious measurement for the standard specified using the [:SENSE]:GSMedge:STANdard commands. The values of frequency and level are returned for maximum 10 peaks that exceeded the standard level in ascending order.

Syntax :FETCh:GSMedge:SPURious?

Arguments None

Returns <snum>{,<freq>,<rdb>}

Where

<snum>::=<NR1> is the number of detected spurious signals, up to 10.

<freq>::=<NRf> is the frequency of spurious in Hz.

<rdb>::=<NRf> is the level of spurious in dBm.

Measurement Modes DEMGSMEDGE

Examples :FETCh:GSMedge:SPURious?
might return 3,1.2E6,-79,2.4E6,-79.59,1E6,-80.38.

Related Commands :INSTrument[:SElect], [:SENSE]:GSMedge:STANdard

:FETCh:GSMedge:SWITching? (Query Only)

Queries the pass/fail result of the GSM/EDGE switching spectrum measurement for the standard specified using the [:SENSe]:GSMedge:STANdard commands.

Syntax :FETCh:GSMedge:SWITching?

Arguments None

Returns <NR1> = 0 indicates Fail.
 <NR1> = 1 indicates Pass.

Measurement Modes DEMGSMEDGE

Examples :FETCh:GSMedge:SWITching?
 might return 1, indicating that the switching spectrum measurement has passed.

Related Commands :INSTrument[:SElect], [:SENSe]:GSMedge:STANdard

:FETCh:GSMedge:TAMPlitude:MCPower? (Query Only)

Fetches the time domain amplitude data of the GSM/EDGE mean carrier power measurement for the burst specified using the [:SENSE]:GSMedge:BURSt:INDEX command.

Syntax :FETCh:GSMedge:TAMPlitude:MCPower?

Returns #<Num_digit><Num_byte><Data(1)><Data(2)>...<Data(n)>

Where

<Num_digit> is the number of digits in <Num_byte>.

<Num_byte> is the number of bytes of data that follow.

<Data(n)> is the absolute power for each symbol in dBm.

4-byte little endian floating-point format specified in IEEE 488.2

n: Max 512000 (= 1024 points × 500 frames)

Invalid data is returned as -1000.

Measurement Modes DEMGSMEDGE

Examples :FETCh:GSMedge:TAMPlitude:MCPower?
might return #510240xxx... (10240-byte data) as the results of the mean carrier power measurement.

Related Commands :INSTrument[:SElect], [:SENSE]:GSMedge:BURSt:INDEX

:FETCh:GSMedge:TAMPlitude:PVTime? (Query Only)

Fetches the time domain amplitude data of the GSM/EDGE power versus time measurement for the time slot specified using the [:SENSe]:GSMedge:BURSt:INDEx command.

Syntax :FETCh:GSMedge:TAMPlitude:PVTime?

Returns #<Num_digit><Num_byte><Data(1)><Data(2)>...<Data(n)>

Where

<Num_digit> is the number of digits in <Num_byte>.

<Num_byte> is the number of bytes of data that follow.

<Data(n)> is the absolute power for each symbol in dBm.

4-byte little endian floating-point format specified in IEEE 488.2

n: Max 512000 (= 1024 points × 500 frames)

Invalid data is returned as -1000.

Measurement Modes DEMGSMEDGE

Examples :FETCh:GSMedge:TAMPlitude:PVTime?
might return #510240xxx... (10240-byte data) as the results of the power versus time measurement.

Related Commands :INSTrument[:SELEct], [:SENSe]:GSMedge:BURSt:INDEx

:FETCh:GSMedg:e:TSCode? (Query Only)

Queries the Training Sequence Code (TSC) number of the burst specified using the [:SENSe]:GSMedg:e:BURSt:INDex command.

Syntax :FETCh:GSMedg:e:TSCode?

Returns <tsc>::=<NR1> is the TSC number (0 to 7).

NOTE. This command is valid when one of the following measurements is finished: *MCPower* (mean carrier power), *PVTime* (power versus time), *MACCuracy* (modulation accuracy), *MODulation* (modulation spectrum), and *SWITching* (switching spectrum). If the measurement is not finished, the error message “-200, Execution Error” is returned.

Measurement Modes DEMGSMEDGE

Examples :FETCh:GSMedg:e:TSCode?
might return 5 of the TSC number.

Related Commands :INSTrument[:SElect], [:SENSe]:GSMedg:e:BURSt:INDex

:FETCh:FLCDMA2K|:RLCDMA2K Subgroup

cdma2000 Analysis, Option 25 Only

The :FETCh:FLCDMA2K|:RLCDMA2K commands return the results of the cdma2000 analysis.

Command Tree	Header	Parameter
	:FETCh	
	:FLCDMA2K :RLCDMA2K	
	:ACPower?	
	:CCDF?	
	:CDPower?	RESult CDPower IQPower
	:CHPower?	
	:Distribution	
	:CCDF?	
	:IM?	
	:MACCuracy?	RESult MACCuracy EVM MERRor PERRor STABle
	:OBWidth?	
	:PCCHannel?	
	:PVTime?	
	:SEMask?	
	:SPECTrum	
	:ACPower?	
	:CHPower?	
	:IM?	
	:OBWidth?	
	:TAMPliitude	
	:PVTime?	

:FETCh:FLCDMA2K|:RLCDMA2K:ACPower? (Query Only)

Returns the results of the ACPR measurement under the cdma2000 forward link or reverse link standard.

Syntax :FETCh:FLCDMA2K|:RLCDMA2K:ACPower?

Arguments None

Returns <pass_fail>,<Chpower>,<Acpr1>,<Acpr2>,<Acpr3>,<Acpr4>,<Acpr5>,<Acpr6>,<Acpr7>,<Acpr8>,<Acpr9>,<Acpr10>,<Acpr11>,<Acpr12>

Where

<pass_fail>::={ 1 | 0 } is the measurement result; 1: Pass or 0: Fail.

<Chpower>::=<NRf> is the channel power measured value in dBm.

<Acpr1>::=<NRf> is the first adjacent channel ACPR in dBc.

<Acpr2>::=<NRf> is the second adjacent channel ACPR in dBc.

.

.

.

<Acpr12>::=<NRf> is the twelfth adjacent channel ACPR in dBc.

<pass_fail> returns 1 (one) when the test is disabled.

Measurement Modes DEMFLCDMA2K, DEMRLCDMA2K

Examples :FETCh:FLCDMA2K:ACPower?
might return 0,-2.045E+001,-6.461E+001,-4.379E+001,-6.576E+001,-6.753E+001,-6.79E+001,-1.0E+038,-1.0E+038,-1.0E+038,-1.0E+038,-1.0E+038,-1.0E+038,-1.0E+038,-1.0E+038 for the ACPR measurement under the cdma2000 forward link standard.

Related Commands :INSTrument[:SELect]

:FETCh:FLCDMA2K|RLCDMA2K:CCDF? (Query Only)

Returns the results of the CCDF measurement under the cdma2000 forward link or reverse link standard.

Syntax :FETCh:FLCDMA2K|:RLCDMA2K:CCDF?

Arguments None

Returns <Mean_power>,<Peak_power>,<Crest_factor>

Where

<Mean_power>::=<NRf> is the average power in dBm.

<Peak_power>::=<NRf> is the peak power in dBm.

<Crest_factor>::=<NRf> is the crest factor in dB.

Measurement Modes DEMFLCDMA2K, DEMRLCDMA2K

Examples :FETCh:FLCDMA2K:CCDF?
might return -1.757E+001,-9.53E+000,8.04E+000 for the CCDF measurement under the cdma2000 forward link standard.

Related Commands :INSTRument[:SElect]

:FETCh:FLCDMA2K|:RLCDMA2K:CDPower? (Query Only)

Returns the results of the code domain power measurement under the cdma2000 forward link or reverse link standard.

Syntax :FETCh:FLCDMA2K|:RLCDMA2K:CDPower? { RESuLt | CDPower | IQPower }

Arguments RESuLt queries the measurement result.

CDPower queries relative/absolute power values of each code.

IQPower queries each I/Q symbol power of the selected code.

Returns Returns are listed below on a per argument basis:

RESuLt. <pass_fail>,<Total_power>,<ACP_max>,<ACP_avg>,<ACP_total>,<No_AC>,<ICP>,<EVM_peak>,<EVM_rms>,<Merror_peak>,<Merror_rms>,<Perror_peak>,<Perror_rms>

Where

<pass_fail>::={1|0} is the measurement result; 1: Pass or 0: Fail.

<Total_power>::=<NRf> is the channel power total value in dBm.

<ACP_max>::=<NRf> is the active channel power maximum value in dBc.

<ACP_avg>::=<NRf> is the active channel power average value in dBc.

<ACP_total>::=<NRf> is the active channel power total value in dBc.

<No_AC>::=<NR1> is the number of active channels.

<ICP>::=<NRf> is the maximum inactive channel power in dBc.

<EVM_peak>::=<NRf> is the EVM peak value in %.

<EVM_rms>::=<NRf> is EVM rms value in %.

<Merror_peak>::=<NRf> is the magnitude error peak value in %.

<Merror_rms>::=<NRf> is the magnitude error rms value in %.

<Perror_peak>::=<NRf> is the phase error peak value in degrees.

<Perror_rms>::=<NRf> is the phase error rms value in degrees.

<pass_fail> returns 1 (one) when the test is disabled.

CDPower. #<Num_digit>,<Num_byte>,<ICpower(1)>,<QCpower(1)>,...,<ICpower(n)>,<QCpower(n)>

Where

<Num_digit> is the number of digits in <Num_byte>.

<Num_byte> is the number of bytes of data that follows.

<ICpower(n)> and <QCpower(n)> is the relative or absolute power value for each code in dB or dBm. When the unit on the Y axis of main view is set to RELative, the relative power value is selected. When the unit on the Y axis of main view is set to ABSolute, the absolute power value is selected. Four-byte little endian floating-point format specified in IEEE 488.2.

n = Max 64 for FLCDMA2K RC1/RC2
Max 128 for FLCDMA2K RC3/RC4/RC5 and RLCDMA2K RC3/RC4

IQPower. #<Num_digit>,<Num_byte>,<Ipower(1)>,<Qpower(1)>,...,
<Ipower(n)>,<Qpower(n)>

Where

<Num_digit> is the number of digits in <Num_byte>.

<Num_byte> is the number of bytes of data that follows.

<Ipower(n)> and <Qpower(n)> is the each I/Q symbol power of selected code.

Four-byte little endian floating-point format specified in IEEE 488.2.

n = Max 24 for symbol measurement in FLCDMA2K RC1/RC2
Max 382 for symbol measurement in FLCDMA2K RC3/RC4/RC5
Max 768 for symbol measurement in RLCDMA2K RC3/RC4
Max 1536 for chip measurement

Measurement Modes DEMFLCDMA2K, DEMRLCDMA2K

Examples :FETCh:FLCDMA2K:CDPower? RESult
might return 0,-3.32076616615568E+001,-2.33279216292314E-004,
-2.33279216292314E-004,-2.33279216292314E-004,16,
-5.53129098248105E+001,1.05323582245638E-001,
9.3576108554992E-002,-9.71313482041643E-002,
7.27630326866468E-002,4.19705794596374E-002,3.37042668803851E-002
for the code domain power measurement for the cdma2000 forward link
standard.

Related Commands :INSTrument[:SElect]

:FETCh:FLCDMA2K|:RLCDMA2K:CHPower? (Query Only)

Returns the results of the channel power measurement under the cdma2000 forward link or reverse link standard.

Syntax :FETCh:FLCDMA2K|:RLCDMA2K:CHPower?

Arguments None

Returns <pass_fail>,<chpower>,<power_density>

Where

<pass_fail>::={ 1 | 0 } is the measurement result; 1: Pass or 0: Fail.

<Chpower>::=<NRf> is the channel power measured value in dBm.

<Power_density>::=<NRf> is the power density measured value in dBm/Hz.

<pass_fail> returns 1 (one) when the test is disabled.

Measurement Modes DEMFLCDMA2K, DEMRLCDMA2K

Examples :FETCh:FLCDMA2K:CHPower?
might return 1,-2.0339E+001,-8.1238E+001 for the channel power measurement under the cdma2000 forward link standard.

Related Commands :INSTrument[:SElect]

:FETCh:FLCDMA2K|:RLCDMA2K:DISTriBution:CCDF? (Query Only)

Returns the distribution data of the CCDF measurement under the cdma2000 forward link or reverse link standard.

Syntax :FETCh:FLCDMA2K|:RLCDMA2K:DISTriBution:CCDF?

Arguments None

Returns #<Num_digit><Num_byte><Data(1)><Data(2)>...<Data(n)>

Where

<Num_digit> is the number of digits in <Num_byte>.

<Num_byte> is the number of bytes of data that follow.

<Data(n)> is the absolute power for each symbol in dBm.

Four-byte little endian floating-point format specified in IEEE 488.2.

n: Max 10001

Invalid data is returned as -1000.

Measurement Modes DEMFLCDMA2K, DEMRLCDMA2K

Examples :FETCh:FLCDMA2K:DISTriBution:CCDF?
might return #510240xxx... (10240-byte data) as the results of the CCDF measurement under the cdma2000 forward link standard.

Related Commands :INSTRument[:SElect]

:FETCh:FLCDMA2K|:RLCDMA2K:IM? (Query Only)

Returns the results of the intermodulation measurement under the cdma2000 forward link or reverse link standard.

Syntax :FETCh:FLCDMA2K|:RLCDMA2K:IM?

Arguments None

Returns <pass_fail>,<L_channel>,<U_channel>,<L3_lower>,<L3_upper>,<U3_lower>,<U3_upper>,<L5_lower>,<L5_upper>,<U5_lower>,<U5_upper>

Where

<pass_fail>::={ 1 | 0 } is the measurement result; 1: Pass or 0: Fail.

<L_channel>::=<NRf> is the lower channel measured value in dBm.

<U_channel>::=<NRf> is the upper channel measured value in dBm.

<L3_lower>::=<NRf> is the lower third order (lower) measured value in dBc.

<L3_upper>::=<NRf> is the lower third order (upper) measured value in dBc.

<U3_lower>::=<NRf> is the upper third order (lower) measured value in dBc.

<U3_upper>::=<NRf> is the upper third order (upper) measured value in dBc.

<L5_lower>::=<NRf> is the lower fifth order (lower) measured value in dBc.

<L5_upper>::=<NRf> is the lower fifth order (upper) measured value in dBc.

<U5_lower>::=<NRf> is the upper fifth order (lower) measured value in dBc.

<U5_upper>::=<NRf> is the upper fifth order (upper) measured value in dBc.

When each value is not present, the value of -1000 is returned.

<pass_fail> returns 1 (one) when the test is disabled.

Measurement Modes DEMFLCDMA2K, DEMRLCDMA2K

Examples :FETCh:FLCDMA2K:IM?
might return 1,-2.061E+001,-5.501E+001,-1.66E+001,1.78E+001,-4.76E+001,-1.32E+001,-4.73E+001,-1.29E+001,-5.1E+001,-1.66E+001
for the intermodulation measurement under the cdma2000 forward link standard.

Related Commands :INSTrument[:SElect]

:FETCh:FLCDMA2K|RLCDMA2K:MACCuracy? (Query Only)

Returns the results of the modulation accuracy measurement under the cdma2000 forward link or reverse link standard.

Syntax :FETCh:FLCDMA2K|RLCDMA2K:MACCuracy? { RESUlt | MACCuracy | EVM | MERRor | PERRor | STABle }

Arguments RESUlt queries the measurement result.
MACCuracy queries the I/Q position of each symbol.
EVM queries the EVM of each symbol.
MERRor queries the magnitude error of each symbol.
PERRor queries the phase error of each symbol.
STABle queries the symbol data for each symbol.

Returns Returns are listed below on a per argument basis:

RESUlt: <pass_fail>,<Rho>,<Peak_CDE>,<CDE_code>,<CDE_I/Q>,<EVM_peak>,<EVM_rms>,<Merror_peak>,<Merror_rms>,<Perror_peak>,<Perror_rms>,<Ferror>,<Org_offset>,<Tau>

Where

<pass_fail>::={ 1 | 0 } is the measurement result; 1: Pass or 0: Fail.

<Rho>::=<NRf> is the measured value of waveform quality (Rho).

<Peak_CDE>::=<NRf> is the code domain error value in dB.

<CDE_code>::=<NR1> is the code number of CDE.

<CDE_I/Q>::=<NR1> is the I/Q channel of CDE. 0: don care, 1: I, 2: Q.

<EVM_peak>::=<NRf> is the EVM peak value in %.

<EVM_rms>::=<NRf> is EVM rms value in %.

<Merror_peak>::=<NRf> is the magnitude error peak value in %.

<Merror_rms>::=<NRf> is the magnitude error rms value in %.

<Perror_peak>::=<NRf> is the phase error peak value in degrees.

<Perror_rms>::=<NRf> is the phase error rms value in degrees.

<Ferror>::=<NRf> is the measured value of frequency error in Hz.

<Org_offset>::=<NRf> is the measured value of origin offset in Hz.

<Tau>::=<NRf> is the measured value of Tau in seconds.

Tau is only available in the forward link standard.

<pass_fail> returns 1 (one) when the test is disabled.

MACCuracy: #<Num_digit>,<Num_byte>,<Iposition(1)>,<Qposition(1)>,...,<Iposition(n)>,<Qposition(n)>

Where

<Num_digit> is the number of digits in <Num_byte>.

<Num_byte> is the number of bytes of data that follows.

<Iposition(n)> and <Qposition(n)> is the I/Q position of each symbol.

Four-byte little endian floating-point format specified in IEEE 488.2.

n = Max 24 for symbol measurement in FLCDMA2K RC1/RC2
 Max 384 for symbol measurement in FLCDMA2K RC3/RC4/RC5
 Max 768 for symbol measurement in RLCDMA2K RC3/RC4
 Max 1536 for chip measurement

EVM: #<Num_digit>,<Num_byte>,<EVM(1)>,...,<EVM(n)>

Where

<Num_digit> is the number of digits in <Num_byte>.

<Num_byte> is the number of bytes of data that follows.

<EVM(n)> is EVM of each symbol.

Four-byte little endian floating-point format specified in IEEE 488.2.

n = Max 24 for symbol measurement in FLCDMA2K RC1/RC2
 Max 384 for symbol measurement in FLCDMA2K RC3/RC4/RC5
 Max 768 for symbol measurement in RLCDMA2K RC3/RC4
 Max 1536 for chip measurement

MERRor: #<Num_digit>,<Num_byte>,<Merror(1)>,...,<Merror(n)>

Where

<Num_digit> is the number of digits in <Num_byte>.

<Num_byte> is the number of bytes of data that follows.

<Merror(n)> is the magnitude error of each symbol.

Four-byte little endian floating-point format specified in IEEE 488.2.

PERRor: #<Num_digit>,<Num_byte>,<Perror(1)>,...,<Perror(n)>

Where

<Num_digit> is the number of digits in <Num_byte>.

<Num_byte> is the number of bytes of data that follows.

<Perror(n)> is the phase error of each symbol.

Four-byte little endian floating-point format specified in IEEE 488.2.

n = Max 24 for symbol measurement in FLCDMA2K RC1/RC2
 Max 384 for symbol measurement in FLCDMA2K RC3/RC4/RC5
 Max 768 for symbol measurement in RLCDMA2K RC3/RC4
 Max 1536 for chip measurement

STABLE: #<Num_digit>,<Num_byte>,<Symbol(1)>,...,<Symbol(n)>

Where

<Num_digit> is the number of digits in <Num_byte>.

<Num_byte> is the number of bytes of data that follows.

<Symbol(n)> is the each symbol data. Four-byte little endian floating-point format specified in IEEE 488.2. For FLCDMA2K, this is only available when Measurement Level is set to Symbol. For RLCDMA2K, this is only available when Measurement Level is set to Symbol and Radio Configuration is set to RC1/RC2. In other cases, the value -1000 returns.

n = Max 24 for symbol measurement in FLCDMA2K RC1/RC2
Max 384 for symbol measurement in FLCDMA2K RC3/RC4/RC5
Max 768 for symbol measurement in RLCDMA2K RC3/RC4
Max 1536 in RLCDMA2K RC1/RC2

Measurement Modes DEMFLCDMA2K, DEMRLCDMA2K

Examples :FETCh:FLCDMA2K:MACCuracy? RESult
might return 1,9.99999124351958E-001,-5.27257858114915E+001,28,1,
1.05323582245638E-001,9.3576108554992E-002,
-9.71313482041643E-002,7.27630326866468E-002,
4.19705794596374E-002,3.37042668803851E-002,
-2.75421142578065E+001,-1.23769373237522E+002,0.0E+000
for the modulation accuracy measurement under the cdma2000 forward link
measurement.

Related Commands :INSTRument[:SElect]

:FETCh:FLCDMA2K|:RLCDMA2K:OBWidth? (Query Only)

Fetches the results of the occupied bandwidth measurement under the cdma2000 forward link or reverse link standard.

Syntax :FETCh:FLCDMA2K|:RLCDMA2K:OBWidth?

Arguments None

Returns <pass_fail>,<obw>

Where

<pass_fail>::={ 1 | 0 } is the measurement result; 1: Pass or 0: Fail.

<obw>::=<NRf> is the occupied bandwidth in Hz.

<pass_fail> returns 1 (one) when the test is disabled.

Measurement Modes DEMFLCDMA2K, DEMRLCDMA2K

Examples :FETCh:FLCDMA2K:OBWidth?
might return 1,1.27333E+006 for the OBW measurement under the cdma2000 forward link standard.

Related Commands :INSTrument[:SElect]

:FETCh:FLCDMA2K|RLCDMA2K:PCCHannel? (Query Only)

Fetches the results of the pilot-to-code channel measurement under the cdma2000 forward link or reverse link standard.

Syntax :FETCh:FLCDMA2K|RLCDMA2K:PCCHannel?

Arguments None

Returns <pass_fail>.<No_AC>{,<SF(n)>,<Code_num(n)>,<Power(n)>,<Timing(n)>,<Phase(n)>,<I_code(n)>,<Q_code(n)>}

Where

<pass_fail>::={ 1 | 0 } is the measurement result; 1: Pass or 0: Fail.

<No_AC>::=<NRf> is the number of active channels.

<SF(n)>::=<NRf> is the spreading factor.

<Code_num(n)>::=<NR1> is the code number.

<Power(n)>::=<NRf> is the code domain power measured value in dBm.

<Timing(n)>::=<NRf> is the pilot channel versus time measured value in seconds.

<Phase(n)>::=<NRf> is the pilot channel versus phase measured value in radian.

<I_code(n)>::=<NRf> is the code domain error of I phase in dBm.

<Q_code(n)>::=<NRf> is the code domain error of Q phase in dBm.

<pass_fail> returns 1 (one) when the test is disabled.

Measurement Modes DEMFLCDMA2K, DEMRLCDMA2K

Examples :FETCh:FLCDMA2K:PCCHannel?
might return 1,2,6,2,-3.62181797592003E+001,7.95659919582192E-009,
2.46966153831218E-003,-7.2188511413898E+001,
-7.25107168870122E+001,6,34,-3.62224724925938E+001,
-7.4505805947922E-010,-3.11469251014973E-003,
-7.1436502569957E+001,-6.58634460703051E+0010 for the pilot to code
channel measurement under the cdma2000 forward link standard.

Related Commands :INSTRument[:SElect]

:FETCh:RLCDMA2K:PVTIme? (Query Only)

Fetches the results of the gated output power measurement under the cdma2000 reverse link standard.

Syntax :FETCh:RLCDMA2K:PVTIme?

Arguments None

Returns <pass_fail>

Where

<pass_fail>::={ 1 | 0 } is the measurement result; 1: Pass or 0: Fail.

<pass_fail> returns 1 (one) when the test is disabled.

Measurement Modes DEMRLCDMA2K

Examples :FETCh:RLCDMA2K:PVTIme?
might return 1, indicating that the gated output power measurement has passed.

Related Commands :INSTrument[:SElect]

:FETCh:FLCDMA2K|RLCDMA2K:SEMask? (Query Only)

Fetches the results of the spectrum emission mask measurement under the cdma2000 forward link or reverse link standard.

Syntax :FETCh:FLCDMA2K|RLCDMA2K:SEMask?

Arguments None

Returns <pass_fail>

Measurement Modes DEMFLCDMA2K, DEMRLCDMA2K

Where

<pass_fail>::={ 1 | 0 } is the measurement result; 1: Pass or 0: Fail.

<pass_fail> returns 1 (one) when the test is disabled.

Examples :FETCh:FLCDMA2K:SEMask?
might return 1, indicating that the spectrum emission mask measurement has passed.

Related Commands :INSTRument[:SElect]

:FETCh:FLCDMA2K|:RLCDMA2K:SPECTrum:ACPowEr? (Query Only)

Returns the spectrum waveform data of the ACPR measurement under the cdma2000 forward link or reverse link standard.

Syntax :FETCh:FLCDMA2K|:RLCDMA2K:SPECTrum:ACPowEr?

Arguments None

Returns #<Num_digit><Num_byte><Data(1)><Data(2)>...<Data(n)>

Where

<Num_digit> is the number of digits in <Num_byte>.

<Num_byte> is the number of bytes of data that follow.

<Data(n)> is the spectrum amplitude in dBm.

Four-byte little endian floating-point format specified in IEEE 488.2.

n: Max 240001

Invalid data is returned as -1000.

Measurement Modes DEMFLCDMA2K, DEMRLCDMA2K

Examples :FETCh:FLCDMA2K:SPECTrum:ACPowEr?
might return #510240xxx... (10240-byte data) as the spectrum waveform data of the ACPR measurement under the cdma2000 forward link standard.

Related Commands :INSTrument[:SElect]

:FETCh:FLCDMA2K|:RLCDMA2K:SPECTrum:CHPower? (Query Only)

Returns the spectrum waveform data of the channel power measurement under the cdma2000 forward link or reverse link standard.

Syntax :FETCh:FLCDMA2K|:RLCDMA2K:SPECTrum:CHPower?

Arguments None

Returns #<Num_digit><Num_byte><Data(1)><Data(2)>...<Data(n)>

Where

<Num_digit> is the number of digits in <Num_byte>.

<Num_byte> is the number of bytes of data that follow.

<Data(n)> is the spectrum amplitude in dBm.

Four-byte little endian floating-point format specified in IEEE 488.2.

n: Max 240001

Invalid data is returned as -1000.

Measurement Modes DEMFLCDMA2K, DEMRLCDMA2K

Examples :FETCh:FLCDMA2K:SPECTrum:CHPower?
might return #510240xxx... (10240-byte data) as the spectrum waveform data of the channel power measurement under the cdma2000 forward link standard.

Related Commands :INSTrument[:SElect]

:FETCh:FLCDMA2K|:RLCDMA2K:SPECTrum:IM? (Query Only)

Returns the spectrum waveform data of the intermodulation measurement under the cdma2000 forward link or reverse link standard.

Syntax :FETCh:FLCDMA2K|:RLCDMA2K:SPECTrum:IM?

Arguments None

Returns #<Num_digit><Num_byte><Data(1)><Data(2)>...<Data(n)>

Where

<Num_digit> is the number of digits in <Num_byte>.

<Num_byte> is the number of bytes of data that follow.

<Data(n)> is the spectrum amplitude in dBm.

Four-byte little endian floating-point format specified in IEEE 488.2.

n: Max 240001

Invalid data is returned as -1000.

Measurement Modes DEMFLCDMA2K, DEMRLCDMA2K

Examples :FETCh:FLCDMA2K:SPECTrum:IM?
might return #510240xxx... (10240-byte data) as the spectrum waveform data of the intermodulation measurement under the cdma2000 forward link standard.

Related Commands :INSTrument[:SElect]

:FETCh:FLCDMA2K|:RLCDMA2K:SPECTrum:OBWidth? (Query Only)

Returns the spectrum waveform data of the occupied bandwidth measurement under the cdma2000 forward link or reverse link standard.

Syntax :FETCh:FLCDMA2K|:RLCDMA2K:SPECTrum:OBWidth?

Arguments None

Returns #<Num_digit><Num_byte><Data(1)><Data(2)>...<Data(n)>

Where

<Num_digit> is the number of digits in <Num_byte>.

<Num_byte> is the number of bytes of data that follow.

<Data(n)> is the spectrum amplitude in dBm.

Four-byte little endian floating-point format specified in IEEE 488.2.

n: Max 240001

Invalid data is returned as -1000.

Measurement Modes DEMFLCDMA2K, DEMRLCDMA2K

Examples :FETCh:FLCDMA2K:SPECTrum:OBWidth?
might return #510240xxx... (10240-byte data) as the spectrum waveform data of the occupied bandwidth measurement under the cdma2000 forward link standard.

Related Commands :INSTrument[:SElect]

:FETCh:RLCDMA2K:TAMPlitude:PVTime? (Query Only)

Returns the time domain amplitude data of the gated output power measurement under the cdma2000 reverse link standard.

Syntax :FETCh:RLCDMA2K:TAMPlitude:PVTime?

Arguments None

Returns #<Num_digit><Num_byte><Data(1)><Data(2)>...<Data(n)>

Where

<Num_digit> is the number of digits in <Num_byte>.

<Num_byte> is the number of bytes of data that follow.

<Data(n)> is the absolute power for each symbol in dBm.

Four-byte little endian floating-point format specified in IEEE 488.2.

n: Max 512000 (= 1024 points × 500 frames)

Invalid data is returned as -1000.

Measurement Modes DEMRLCDMA2K

Examples :FETCh:RLCDMA2K:TAMPlitude:PVTime?
might return #510240xxx... (10240-byte data) as the results of the gated output power measurement under the cdma2000 reverse link standard.

Related Commands :INSTrument[:SElect]

:FETCh:FL1XEVD0|:RL1XEVD0 Subgroup

1xEV-DO Analysis, Option 26 Only

The :FETCh:FL1XEVD0|:RL1XEVD0 commands return the results of the 1xEV-DO analysis.

Command Tree	Header	Parameter
	:FETCh	
	:FL1XEVD0 :RL1XEVD0	
	:ACPR?	
	:CCDF?	
	:CDPower?	RESult CDPower IQPower
	:CHPower?	
	:Distribution	
	:CCDF?	
	:IM?	
	:MACCuracy?	RESult MACCuracy EVM MERRor PERRor STABle
	:OBWidth?	
	:PCCHannel?	
	:PVTime?	
	:SEMask?	
	:SPECTrum	
	:ACPower?	
	:CHPower?	
	:IM?	
	:OBWidth?	
	:TAMPliitude	
	:PVTime?	

:FETCh:FL1XEVD0|:RL1XEVD0:ACPower? (Query Only)

Returns the results of the ACPR measurement under the 1xEV-DO forward link or reverse link standard.

Syntax :FETCh:FL1XEVD0|:RL1XEVD0:ACPower?

Arguments None

Returns <pass_fail>,<chpower>,<acpr1>,<acpr2>,<acpr3>,<acpr4>,<acpr5>,<acpr6>,<acpr7>,<acpr8>,<acpr9>,<acpr10>,<acpr11>,<acpr12>

Where

<pass_fail>::={ 1 | 0 } is the measurement result; 1: Pass or 0: Fail.

<chpower>::=<NRf> is the channel power measured value in dBm.

<acpr1>::=<NRf> is the first adjacent channel ACPR in dBc.

<acpr2>::=<NRf> is the second adjacent channel ACPR in dBc.

.

.

.

<acpr12>::=<NRf> is the twelfth adjacent channel ACPR in dBc.

<pass_fail> returns 1 (one) when the test is disabled.

Measurement Modes DEMFL1XEVD0, DEMRL1XEVD0

Examples :FETCh:FL1XEVD0:ACPower?
might return 0,-2.045E+001,-6.461E+001,-4.379E+001,-6.576E+001,-6.753E+001,-6.79E+001,-1.0E+038,-1.0E+038,-1.0E+038,-1.0E+038,-1.0E+038,-1.0E+038,-1.0E+038,-1.0E+038 for the ACPR measurement under the 1xEV-DO forward link standard.

Related Commands :INSTrument[:SELect]

:FETCh:FL1XEVD0|:RL1XEVD0:CCDF? (Query Only)

Returns the results of the CCDF measurement under the 1xEV-DO forward link or reverse link standard.

Syntax :FETCh:FL1XEVD0|:RL1XEVD0:CCDF?

Arguments None

Returns <Mean_power>,<Peak_power>,<Crest_factor>

Where

<Mean_power>::=<NRf> is the average power in dBm.

<Peak_power>::=<NRf> is the peak power in dBm.

<Crest_factor>::=<NRf> is the crest factor in dB.

Measurement Modes DEMFL1XEVD0, DEMRL1XEVD0

Examples :FETCh:FL1XEVD0:CCDF?
might return -1.757E+001,-9.53E+000,8.04E+000 for the CCDF measurement under the 1xEV-DO forward link standard.

Related Commands :INSTRument[:SElect]

:FETCh:FL1XEVD0|:RL1XEVD0:CDPower? (Query Only)

Returns the results of the code domain power measurement under the 1xEV-DO forward link or reverse link standard.

Syntax :FETCh:FL1XEVD0|:RL1XEVD0:CDPower? { RESuLt | CDPower | IQPower }

Arguments RESuLt queries the measurement result.

CDPower queries relative/absolute power values of each code.

IQPower queries each I/Q symbol power of the selected code.

Returns Returns are listed below on a per argument basis for the forward and reverse link measurements:

FL1XEVD0. Returns for the forward link measurement are shown below:

RESuLt: <pass_fail>,<Total_power>,<ACP_max>,<ACP_avg>,<ACP_total>,<ICP>,<EVM_peak>,<EVM_rms>,<Merror_peak>,<Merror_rms>,<Perror_peak>,<Perror_rms>

Where

<pass_fail>::={ 1 | 0 } is the measurement result; 1: Pass or 0: Fail.

<Total_power>::=<NRf> is the channel power total value in dBm.

<ACP_max>::=<NRf> is the active channel power maximum value in dBc.

<ACP_avg>::=<NRf> is the active channel power average value in dBc.

<ACP_total>::=<NRf> is the active channel power total value in dBc.

<ICP>::=<NRf> is the maximum inactive channel power in dBc.

<EVM_peak>::=<NRf> is the EVM peak value in %.

<EVM_rms>::=<NRf> is EVM rms value in %.

<Merror_peak>::=<NRf> is the magnitude error peak value in %.

<Merror_rms>::=<NRf> is the magnitude error rms value in %.

<Perror_peak>::=<NRf> is the phase error peak value in degrees.

<Perror_rms>::=<NRf> is the phase error rms value in degrees.

<pass_fail> returns 1 (one) when the test is disabled.

CDPower: #<Num_digit>,<Num_byte>,<ICpower(1)>,<QCpower(1)>,...,<ICpower(n)>,<QCpower(n)>

Where

<Num_digit> is the number of digits in <Num_byte>.

<Num_byte> is the number of bytes of data that follows.

<ICpower(n)> and <QCpower(n)> is the relative or absolute power value for each code in dB or dBm. When the unit on the Y axis of main view is set to RELative, the relative power value is selected. When the unit on the Y axis of main view is set to ABSolute, the absolute power value is selected. Four-byte little endian floating-point format specified in IEEE 488.2.

Table 2-71: The n value for CDPower

Channel	n
Overall	640
MAC	64
Pilot	32
Data	Max 16
Preamble	Max 32

IQPower: #<Num_digit>,<Num_byte>,<Ipower(1)>,<Qpower(1)>,...,<Ipower(n)>,<Qpower(n)>

Where

<Num_digit> is the number of digits in <Num_byte>.

<Num_byte> is the number of bytes of data that follows.

<Ipower(n)> and <Qpower(n)> is the each I/Q symbol power of selected code.

4-byte little endian floating-point format specified in IEEE 488.2. n: Max 1024

Table 2-72: The n value for IQPower

Channel	Chip	Symbol
Overall	1024	0
MAC	128	2
Pilot	96	3
Data	Max 800	Max 50
Preamble	Max 800	Max 25

RL1XEVD0. Returns for the reverse link measurement are shown below:

RESult: <pass_fail>,<Total_power>,<PCP1>,<ACP_max>,<ACP_avg>,<ACP_total>,<ICP>,<Num_AC>,<EVM_peak>,<EVM_rms>,<Merror_peak>,<Merror_rms>,<Perror_peak>,<Perror_rms>,<PCP2>,<RRI_CP>,<ACK_CP>,<DRC_CP>,<Data_CP>

Where

<pass_fail>::={ 1 | 0 } is the measurement result; 1: Pass or 0: Fail.

<Total_power>::=<NRf> is the channel power total value in dBm.

<PCP1>::=<NRf> is the pilot channel power value in dBc

(includes RRI channel).

<ACP_max>::=<NRf> is the active channel power maximum value in dBc.

<ACP_avg>::=<NRf> is the active channel power average value in dBc.

<ACP_total>::=<NRf> is the active channel power total value in dBc.

<ICP>::=<NRf> is the maximum inactive channel power in dBc.

<Num_AC>::=<NR1> is the number of active channels.

<EVM_peak>::=<NRf> is the EVM peak value in %.

<EVM_rms>::=<NRf> is EVM rms value in %.

<Merror_peak>::=<NRf> is the magnitude error peak value in %.

<Merror_rms>::=<NRf> is the magnitude error rms value in %.

<Perror_peak>::=<NRf> is the phase error peak value in degrees.

<Perror_rms>::=<NRf> is the phase error rms value in degrees.

<PCP2>::=<NRf> is the pilot channel power value in dBc

(excludes RRI channel).

<RRI_CP>::=<NRf> is the RRI channel power value in dB

(excludes Pilot channel).

<ACK_CP>::=<NRf> is the ACK channel power value in dB.

<DRC_CP>::=<NRf> is the DRC channel power value in dB.

<Data_CP>::=<NRf> is the data channel power value in dB.

<pass_fail> returns 1 (one) when the test is disabled.

CDPower: #<Num_digit>,<Num_byte>,<ICpower(1)>,<QCpower(1)>,...,<ICpower(n)>,<QCpower(n)>

Where

<Num_digit> is the number of digits in <Num_byte>.

<Num_byte> is the number of bytes of data that follows.

<ICpower(n)> and <QCpower(n)> is the relative or absolute power value for each code in dB or dBm. When the unit on the Y axis of main view is set to RELative, the relative power value is selected. When the unit on the Y axis of main view is set to ABSolute, the absolute power value is selected. Four-byte little endian floating-point format specified in IEEE 488.2. n=16

IQPower: #<Num_digit>,<Num_byte>,<Ipower(1)>,<Qpower(1)>,...,
<Ipower(n)>,<Qpower(n)>

Where

<Num_digit> is the number of digits in <Num_byte>.

<Num_byte> is the number of bytes of data that follows.

<Ipower(n)> and <Qpower(n)> is the each I/Q symbol power of selected code.
4-byte little endian floating-point format specified in IEEE 488.2. n: Max 1024

n = 1024 for the chip measurement level

256 for the symbol measurement level

Measurement Modes DEMFL1XEVD0, DEMRL1XEVD0

Examples :FETCh:FL1XEVD0:CDPower? RESult
might return 0,-3.32076616615568E+001,-2.33279216292314E-004,
-2.33279216292314E-004,-2.33279216292314E-004,
-5.53129098248105E+001,1.05323582245638E-001,
9.3576108554992E-002,-9.71313482041643E-002,
7.27630326866468E-002,4.19705794596374E-002,3.37042668803851E-002
for the code domain power measurement for the 1xEV-DO forward link standard.

Related Commands :INSTRument[:SElect]

:FETCh:FL1XEVD0|:RL1XEVD0:CHPower? (Query Only)

Returns the results of the channel power measurement under the 1xEV-DO forward link or reverse link standard.

Syntax :FETCh:FL1XEVD0|:RL1XEVD0:CHPower?

Arguments None

Returns <pass_fail>,<Chpower>,<Power_density>

Where

<pass_fail>::={1|0} is the measurement result; 1: Pass or 0: Fail.

<Chpower>::=<NRf> is the channel power measured value in dBm.

<Power_density>::=<NRf> is the power density measured value in dBm/Hz.

<pass_fail> returns 1 (one) when the test is disabled.

Measurement Modes DEMFL1XEVD0, DEMRL1XEVD0

Examples :FETCh:FL1XEVD0:CHPower?
might return 1,-2.0375E+001,-8.1274E+001 for the channel power measurement under the 1xEV-DO forward link standard.

Related Commands :INSTrument[:SElect]

:FETCh:FL1XEVD0|:RL1XEVD0:DISTriBution:CCDF? (Query Only)

Fetches the distribution data of the CCDF measurement under the 1xEV-DO forward link or reverse link standard.

Syntax :FETCh:FL1XEVD0|:RL1XEVD0:DISTriBution:CCDF?

Arguments None

Returns #<Num_digit><Num_byte><Data(1)><Data(2)>...<Data(n)>

Where

<Num_digit> is the number of digits in <Num_byte>.

<Num_byte> is the number of bytes of data that follow.

<Data(n)> is the absolute power for each symbol in dBm.

Four-byte little endian floating-point format specified in IEEE 488.2.

n: Max 10001

Invalid data is returned as -1000.

Measurement Modes DEMFL1XEVD0, DEMRL1XEVD0

Examples :FETCh:FL1XEVD0:DISTriBution:CCDF?
might return #510240xxx... (10240-byte data) as the results of the CCDF measurement under the 1xEV-DO forward link standard.

Related Commands :INSTRument[:SElect]

:FETCh:FL1XEVD0|:RL1XEVD0:IM? (Query Only)

Returns the results of the intermodulation measurement under the 1xEV-DO forward link or reverse link standard.

Syntax :FETCh:FL1XEVD0|:RL1XEVD0:IM?

Arguments None

Returns <pass_fail>,<L_channel>,<U_channel>,<L3_lower>,<L3_upper>,<U3_lower>,<U3_upper>,<L5_lower>,<L5_upper>,<U5_lower>,<U5_upper>

Where

<Pass_fail>::={ 1 | 0 } is the measurement result; 1: Pass or 0: Fail.

<L_channel>::=<NRf> is the lower channel measured value in dBm.

<U_channel>::=<NRf> is the upper channel measured value in dBm.

<L3_lower>::=<NRf> is the lower third order (lower) measured value in dBc.

<L3_upper>::=<NRf> is the lower third order (upper) measured value in dBc.

<U3_lower>::=<NRf> is the upper third order (lower) measured value in dBc.

<U3_upper>::=<NRf> is the upper third order (upper) measured value in dBc.

<L5_lower>::=<NRf> is the lower fifth order (lower) measured value in dBc.

<L5_upper>::=<NRf> is the lower fifth order (upper) measured value in dBc.

<U5_lower>::=<NRf> is the upper fifth order (lower) measured value in dBc.

<U5_upper>::=<NRf> is the upper fifth order (upper) measured value in dBc.

When each value is not present, the value of -1000 is returned.

<pass_fail> returns 1 (one) when the test is disabled.

Measurement Modes DEMFL1XEVD0, DEMRL1XEVD0

Examples :FETCh:FL1XEVD0:IM?
might return 1,-2.061E+001,-5.501E+001,-1.66E+001,1.78E+001,-4.76E+001,-1.32E+001,-4.73E+001,-1.29E+001,-5.1E+001,-1.66E+001 for the intermodulation measurement under the 1xEV-DO forward link standard.

Related Commands :INSTrument[:SElect]

:FETCh:FL1XEVD0|:RL1XEVD0:MACCuracy? (Query Only)

Returns the results of the modulation accuracy measurement under the 1xEV-DO forward link or reverse link standard.

Syntax :FETCh:FL1XEVD0|:RL1XEVD0:MACCuracy? { RESUlt | MACCuracy | EVM | MERRor | PERRor | STABle }

Arguments None

Returns Returns are listed below on a per argument basis for the forward and reverse link measurements:

FL1XEVD0. Returns for the forward link measurement are shown below:

RESUlt. <pass_fail>,<Rho>,<Rho2>,<Peak_CDE>,<CDE_code>,<CDE_I/Q>,<EVM_peak>,<EVM_rms>,<Merror_peak>,<Merror_rms>,<Perror_peak>,<Perror_rms>,<Ferror>,<Org_offset>,<Tau>

Where

<Pass_fail>::={ 1 | 0 } is the measurement result; 1: Pass or 0: Fail.

<Rho>::=<NRf> is the measured value of waveform quality (Rho).

<Rho2>::=<NRf> is the measured value of the waveform quality (Rho2). This value is only available when Measurement Level is set to Chip and Channel Type is set to Overall. In other cases, the value -1000 returns.

<Peak_CDE>::=<NRf> is the code domain error value in dB.

<CDE_code>::=<NR1> is the code number of CDE.

<CDE_I/Q>::=<NR1> is the I/Q channel of CDE. 0: don't care, 1: I, 2: Q.

<EVM_peak>::=<NRf> is the EVM peak value in %.

<EVM_rms>::=<NRf> is EVM rms value in %.

<Merror_peak>::=<NRf> is the magnitude error peak value in %.

<Merror_rms>::=<NRf> is the magnitude error rms value in %.

<Perror_peak>::=<NRf> is the phase error peak value in degrees.

<Perror_rms>::=<NRf> is the phase error rms value in degrees.

<Ferror>::=<NRf> is the measured value of frequency error in Hz.

<Org_offset>::=<NRf> is the measured value of origin offset in Hz.

<Tau>::=<NRf> is the measured value of Tau in seconds.

<pass_fail> returns 1 (one) when the test is disabled.

MACCuracy. #<Num_digit>,<Num_byte>,<Iposition(1)>,<Qposition(1)>,...,<Iposition(n)>,<Qposition(n)>

Where

<Num_digit> is the number of digits in <Num_byte>.

<Num_byte> is the number of bytes of data that follows.

<Iposition(n)> and <Qposition(n)> is the I/Q position of each symbol.

Four-byte little endian floating-point format specified in IEEE 488.2.

n: Max 1024

Table 2-73: The n value for MACCuracy

Channel	Chip	Symbol
Overall	1024	0
MAC	128	2
Pilot	96	3
Data	Max 800	Max 50
Preamble	Max 800	Max 25

EVM. #<Num_digit>,<Num_byte>,<EVM(1)>,...,<EVM(n)>

Where

<Num_digit> is the number of digits in <Num_byte>.

<Num_byte> is the number of bytes of data that follows.

<EVM(n)> is EVM of each symbol.

Four-byte little endian floating-point format specified in IEEE 488.2.

n: Max 1024

The n value is the same as for MACCuracy shown in Table 2-73.

MERRor. #<Num_digit>,<Num_byte>,<Merror(1)>,...,<Merror(n)>

Where

<Num_digit> is the number of digits in <Num_byte>.

<Num_byte> is the number of bytes of data that follows.

<Merror(n)> is the magnitude error of each symbol.

Four-byte little endian floating-point format specified in IEEE 488.2.

n: Max 1024

The n value is the same as for MACCuracy shown in Table 2-73.

PERRor. #<Num_digit>,<Num_byte>,<Perror(1)>,...,<Perror(n)>

Where

<Num_digit> is the number of digits in <Num_byte>.

<Num_byte> is the number of bytes of data that follows.

<Perror(n)> is the phase error of each symbol.

Four-byte little endian floating-point format specified in IEEE 488.2.

n: Max 1024

The n value is the same as for MACCuracy shown in Table 2-73.

STABLE. #<Num_digit>,<Num_byte>,<Symbol(1)>,...,<Symbol(n)>

Where

<Num_digit> is the number of digits in <Num_byte>.

<Num_byte> is the number of bytes of data that follows.

<Symbol(n)> is the each symbol data.

Four-byte little endian floating-point format specified in IEEE 488.2.

This value is only available when Measurement Level is set to Symbol.

In other cases, the value -1000 returns.

Table 2-74: The n value for STABLE

Channel	n
MAC	2
Pilot	3
Data	Max 50
Preamble	Max 25

RL1XEVD0. Returns for the reverse link measurement are shown below:

RESult. <Pass_fail>,<Rho>,<Peak_CDE>,<CDE_code>,<CDE_I/Q>,<EVM_peak>,<EVM_rms>,<Merror_peak>,<Merror_rms>,<Perror_peak>,<Perror_rms>,<Ferror>,<Org_offset>

Where

<Pass_fail>::={ 1 | 0 } is the measurement result; 1: Pass or 0: Fail.

<Rho>::=<NRf> is the measured value of waveform quality (Rho).

<Peak_CDE>::=<NRf> is the code domain error value in dB.

<CDE_code>::=<NR1> is the code number of CDE.

<CDE_I/Q>::=<NR1> is the I/Q channel of CDE. 0: don care, 1: I, 2: Q.

<EVM_peak>::=<NRf> is the EVM peak value in %.

<EVM_rms>::=<NRf> is EVM rms value in %.

<Merror_peak>::=<NRf> is the magnitude error peak value in %.

<Merror_rms>::=<NRf> is the magnitude error rms value in %.

<Perror_peak>::=<NRf> is the phase error peak value in degrees.

<Perror_rms>::=<NRf> is the phase error rms value in degrees.

<Ferror>::=<NRf> is the measured value of frequency error in Hz.

<Org_offset>::=<NRf> is the measured value of origin offset in Hz.

<pass_fail> returns 1 (one) when the test is disabled.

MACCuracy. #<Num_digit>,<Num_byte>,<Iposition(1)>,<Qposition(1)>,...,<Iposition(n)>,<Qposition(n)>

Where

<Num_digit> is the number of digits in <Num_byte>.

<Num_byte> is the number of bytes of data that follows.

<Iposition(n)> and <Qposition(n)> is the I/Q position of each symbol.

Four-byte little endian floating-point format specified in IEEE 488.2.

n: Max 1024.

n = 1024 for the chip measurement level
256 for the symbol measurement level

EVM. #<Num_digit>,<Num_byte>,<EVM(1)>,...,<EVM(n)>

Where

<Num_digit> is the number of digits in <Num_byte>.

<Num_byte> is the number of bytes of data that follows.

<EVM(n)> is EVM of each symbol.

Four-byte little endian floating-point format specified in IEEE 488.2.

n: Max 1024.

n = 1024 for the chip measurement level
256 for the symbol measurement level

MERRor. #<Num_digit>,<Num_byte>,<Merror(1)>,...,<Merror(n)>

Where

<Num_digit> is the number of digits in <Num_byte>.

<Num_byte> is the number of bytes of data that follows.

<Merror(n)> is the magnitude error of each symbol.

Four-byte little endian floating-point format specified in IEEE 488.2.

n: Max 1024

n = 1024 for the chip measurement level

256 for the symbol measurement level

PERRor. #<Num_digit>,<Num_byte>,<Perror(1)>,...,<Perror(n)>

Where

<Num_digit> is the number of digits in <Num_byte>.

<Num_byte> is the number of bytes of data that follows.

<Perror(n)> is the phase error of each symbol.

Four-byte little endian floating-point format specified in IEEE 488.2.

n: Max 1024

n = 1024 for the chip measurement level

256 for the symbol measurement level

STABLE. #<Num_digit>,<Num_byte>,<Symbol(1)>,...,<Symbol(n)>

Where

<Num_digit> is the number of digits in <Num_byte>.

<Num_byte> is the number of bytes of data that follows.

<Symbol(n)> is the each symbol data. Four-byte little endian floating-point format specified in IEEE 488.2. This value is only available when Measurement Level is set to Symbol. In other cases, the value -1000 returns. n: Max 256

Measurement Modes DEMFL1XEVD0, DEMRL1XEVD0

Examples :FETCh:FL1XEVD0:MACCuracy? RESult
might return 1,9.99999124351958E-001,-1.0E+003,
-5.27257858114915E+001,28,1,1.05323582245638E-001,
9.3576108554992E-002,-9.71313482041643E-002,
7.27630326866468E-002,4.19705794596374E-002,
3.37042668803851E-002,-2.75421142578065E+001,
-1.23769373237522E+002,0.0E+000 for the modulation accuracy measurement
under the 1xEV-DO forward link measurement.

Related Commands :INSTrument[:SELEct]

:FETCh:FL1XEVD0|:RL1XEVD0:OBWidth? (Query Only)

Fetches the results of the occupied bandwidth measurement under the 1xEV-DO forward link or reverse link standard.

Syntax :FETCh:FL1XEVD0|:RL1XEVD0:OBWidth?

Arguments None

Returns <pass_fail>,<obw>

Where

<Pass_fail>::={ 1 | 0 } is the measurement result; 1: Pass or 0: Fail.

<obw>::=<NRf> is the occupied bandwidth in Hz.

<pass_fail> returns 1 (one) when the test is disabled.

Measurement Modes DEMFL1XEVD0, DEMRL1XEVD0

Examples :FETCh:FL1XEVD0:OBWidth?
might return 1,1.27333E+006 for the OBW measurement under the 1xEV-DO forward link standard.

Related Commands :INSTrument[:SElect]

:FETCh:FL1XEVD0|:RL1XEVD0:PCCHannel? (Query Only)

Fetches the results of the pilot-to-code channel measurement under the 1xEV-DO forward link or reverse link standard.

Syntax :FETCh:FL1XEVD0|:RL1XEVD0:PCCHannel?

Arguments None

Returns Returns are listed for the forward and reverse link measurements:

FL1XEVD0. <pass_fail>.<Total_AC>{,<SF(n)>,<Code_num(n)>,<Power(n)>,<Timing(n)>,<Phase(n)>,<I_code(n)>,<Q_code(n)>}

Where

<Pass_fail>::={ 1 | 0 } is the measurement result; 1: Pass or 0: Fail.

<Total_AC>::=<NRf> is the total active channel number

(MAC: n=2 to 60, DATA: n=16, Preamble: n=1).

<SF(n)>::=<NRf> is the spreading factor.

<Code_num(n)>::=<NR1> is the code number.

<Power(n)>::=<NRf> is code domain power measured value in dBm.

<Timing(n)>::=<NRf> is the pilot channel versus time measured value in seconds.

<Phase(n)>::=<NRf> is the pilot channel versus phase measured value in radian.

<I_code(n)>::=<NRf> is the code domain error of I phase in dBm.

<Q_code(n)>::=<NRf> is the code domain error of Q phase in dBm.

<pass_fail> returns 1 (one) when the test is disabled.

RL1XEVD0. <pass_fail>.<Total_AC>{,<SF(n)>,<Code_num(n)>,<Power(n)>,<Timing(n)>,<Phase(n)>,<I_code(n)>,<Q_code(n)>}

Where

<pass_fail>::={ 1 | 0 } is the measurement result; 1: Pass or 0: Fail.

<Total_AC>::=<NRf> is the total active channel number (n=1 to 4).

<SF(n)>::=<NRf> is the spreading factor.

<Code_num(n)>::=<NR1> is the code number.

<Power(n)>::=<NRf> is code domain power measured value in dBm.

<Timing(n)>::=<NRf> is the pilot channel versus time measured value in seconds.

<Phase(n)>::=<NRf> is the pilot channel versus phase measured value in radian.

<I_code(n)>::=<NRf> is the code domain error of I phase in dBm.

<Q_code(n)>::=<NRf> is the code domain error of Q phase in dBm.

<pass_fail> returns 1 (one) when the test is disabled.

Measurement Modes DEMFL1XEVD0, DEMRL1XEVD0

Examples :FETCh:FL1XEVD0:PCCHannel?
 might return 1,2,6,2,-3.62181797592003E+001,7.95659919582192E-009,
 2.46966153831218E-003,-7.2188511413898E+001,
 -7.25107168870122E+001,6,34,-3.62224724925938E+001,
 -7.4505805947922E-010,-3.11469251014973E-003,
 -7.1436502569957E+001,-6.58634460703051E+001 for the pilot to code
 channel measurement under the 1xEV-DO forward link measurement.

Related Commands :INSTrument[:SElect]

:FETCh:FL1XEVD0:PVTIme? (Query Only)

Fetches the results of the gated output power measurement under the 1xEV-DO forward link standard.

Syntax :FETCh:FL1XEVD0:PVTIme?

Arguments None

Returns <pass_fail>

Where

<pass_fail>::={ 1 | 0 } is the measurement result; 1: Pass or 0: Fail.

<pass_fail> returns 1 (one) when the test is disabled.

Measurement Modes DEMFL1XEVD0

Examples :FETCh:FL1XEVD0:PVTIme?
 might return 1, indicating that the gated output power measurement has passed.

Related Commands :INSTrument[:SElect]

:FETCh:FL1XEVD0|:RL1XEVD0:SEMask? (Query Only)

Fetches the results of the spectrum emission mask measurement under the 1xEV-DO forward link or reverse link standard.

Syntax :FETCh:FL1XEVD0|:RL1XEVD0:SEMask?

Arguments None

Returns <pass_fail>

Where

<pass_fail>::={ 1 | 0 } is the measurement result; 1: Pass or 0: Fail.

<pass_fail> returns 1 (one) when the test is disabled.

Measurement Modes DEMFL1XEVD0, DEMRL1XEVD0

Examples :FETCh:FL1XEVD0:SEMask?
might return 1, indicating that the spectrum emission mask measurement has passed.

Related Commands :INSTRument[:SElect]

:FETCh:FL1XEVD0|:RL1XEVD0:SPECTrum:ACPowEr? (Query Only)

Fetches the spectrum waveform data of the ACPR measurement under the 1xEV-DO forward link or reverse link standard.

Syntax :FETCh:FL1XEVD0|:RL1XEVD0:SPECTrum:ACPowEr?

Arguments None

Returns #<Num_digit><Num_byte><Data(1)><Data(2)>...<Data(n)>

Where

<Num_digit> is the number of digits in <Num_byte>.

<Num_byte> is the number of bytes of data that follow.

<Data(n)> is the spectrum amplitude in dBm.

Four-byte little endian floating-point format specified in IEEE 488.2.

n: Max 240001

Invalid data is returned as -1000.

Measurement Modes DEMFL1XEVD0, DEMRL1XEVD0

Examples :FETCh:FL1XEVD0:SPECTrum:ACPowEr?
might return #510240xxx... (10240-byte data) as the spectrum waveform data of the ACPR measurement under the 1xEV-DO forward link standard.

Related Commands :INSTrument[:SElect]

:FETCh:FL1XEVD0|:RL1XEVD0:SPECTrum:CHPower? (Query Only)

Fetches the spectrum waveform data of the channel power measurement under the 1xEV-DO forward link or reverse link standard.

Syntax :FETCh:FL1XEVD0|:RL1XEVD0:SPECTrum:CHPower?

Arguments None

Returns #<Num_digit><Num_byte><Data(1)><Data(2)>...<Data(n)>

Where

<Num_digit> is the number of digits in <Num_byte>.

<Num_byte> is the number of bytes of data that follow.

<Data(n)> is the spectrum amplitude in dBm.

Four-byte little endian floating-point format specified in IEEE 488.2.

n: Max 240001

Invalid data is returned as -1000.

Measurement Modes DEMFL1XEVD0, DEMRL1XEVD0

Examples :FETCh:FL1XEVD0:SPECTrum:CHPower?
might return #510240xxx... (10240-byte data) as the spectrum waveform data of the channel power measurement under the 1xEV-DO forward link standard.

Related Commands :INSTRument[:SELect]

:FETCh:FL1XEVD0|:RL1XEVD0:SPECTrum:IM? (Query Only)

Fetches the spectrum waveform data of the intermodulation measurement under the 1xEV-DO forward link or reverse link standard.

Syntax :FETCh:FL1XEVD0|:RL1XEVD0:SPECTrum:IM?

Arguments None

Returns #<Num_digit><Num_byte><Data(1)><Data(2)>...<Data(n)>

Where

<Num_digit> is the number of digits in <Num_byte>.

<Num_byte> is the number of bytes of data that follow.

<Data(n)> is the spectrum amplitude in dBm.

Four-byte little endian floating-point format specified in IEEE 488.2.

n: Max 240001

Invalid data is returned as -1000.

Measurement Modes DEMFL1XEVD0, DEMRL1XEVD0

Examples :FETCh:FL1XEVD0:SPECTrum:IM?
might return #510240xxx... (10240-byte data) as the spectrum waveform data of the intermodulation measurement under the 1xEV-DO forward link standard.

Related Commands :INSTrument[:SElect]

:FETCh:FL1XEVD0|:RL1XEVD0:SPECTrum:OBWidth? (Query Only)

Fetches the spectrum waveform data of the occupied bandwidth measurement under the 1xEV-DO forward link or reverse link standard.

Syntax :FETCh:FL1XEVD0|:RL1XEVD0:SPECTrum:OBWidth?

Arguments None

Returns #<Num_digit><Num_byte><Data(1)><Data(2)>...<Data(n)>

Where

<Num_digit> is the number of digits in <Num_byte>.

<Num_byte> is the number of bytes of data that follow.

<Data(n)> is the spectrum amplitude in dBm.

Four-byte little endian floating-point format specified in IEEE 488.2.

n: Max 240001

Invalid data is returned as -1000.

Measurement Modes DEMFL1XEVD0, DEMRL1XEVD0

Examples :FETCh:FL1XEVD0:SPECTrum:OBWidth?
might return #510240xxx... (10240-byte data) as the spectrum waveform data of the occupied bandwidth measurement under the 1xEV-DO forward link standard.

Related Commands :INSTRument[:SElect]

:FETCh:FL1XEVD0:TAMPlitude:PVTIme? (Query Only)

Fetches the time domain amplitude data of the gated output power measurement under the 1xEV-DO forward link standard.

Syntax :FETCh:FL1XEVD0:TAMPlitude:PVTIme?

Arguments None

Returns #<Num_digit><Num_byte><Data(1)><Data(2)>...<Data(n)>

Where

<Num_digit> is the number of digits in <Num_byte>.

<Num_byte> is the number of bytes of data that follow.

<Data(n)> is the absolute power for each symbol in dBm.

Four-byte little endian floating-point format specified in IEEE 488.2.

n: Max 512000 (= 1024 points × 500 frames)

Invalid data is returned as -1000.

Measurement Modes DEMFL1XEVD0

Examples :FETCh:FL1XEVD0:TAMPlitude:PVTIme?
might return #510240xxx... (10240-byte data) as the results of the gated output power measurement under the 1xEV-DO forward link standard.

Related Commands :INSTrument[:SElect]

:FETCh:DLR5_3GPP Subgroup

DLR5_3GPP Analysis, Option 27 Only

The :FETCh:DLR5_3GPP commands return the results of the 3GPP-R5 downlink analysis.

For the :FETCh:DLR5_3GPP command subgroups, if you want to perform a FETCh operation on fresh data, use the [:SENSe]:DLR5_3GPP[:IMMediate] command.

Command Tree	Header	Parameter
	:FETCh	
	:DLR5_3GPP?	CSHortcode CCODe CSYMBOL CTSLOT SCOnStE EVM AEVM PEVM MErRor AMErRor PMErRor PErRor APErRor PPErRor RHO FErRor OOFFset STABle TSNumber SSCHannel SCGRoup SCNumber TLEnGth PCDE CEVM CMErRor CPErRor CRHO COOF

:FETCh:DLR5_3GPP? (Query Only)

Returns measurement results of the 3GPP-R5 downlink modulation analysis.

Syntax :FETCh:DLR5_3GPP? { CSHortcode | CCODe | CSYMBOL | CTSLOT
| SCONSte | EVM | AEVM | PEVM | MERRor | AMERRor | PMERRor
| PERRor | APERRor | PPERRor | RHO | FERRor | OOFFset | STABLE
| TSNumber | SSCHannel | SCGRoup | SCNumber | TLENgth | PCDE
| CEVM | CMERRor | CPERror | CRHO | COOF }

Arguments Information queried is listed below for each of the arguments:

Table 2-75: Queried information on the 3GPP-R5 downlink analysis results

Argument	Information queried
CSHortcode	Power of each short code for the specified TS
CCODe	Power of each channelization code for the specified TS
CSYMBOL	Each symbol power of the specified TS/CC
CTSLOT	Power of each time slot for the specified CC
SCONSte	Symbol position data for the specified TS/CC
EVM	Measurement results of Error Vector Magnitude for the specified TS/CC
AEVM	RMS value of EVM for the specified TS/CC
PEVM	Peak value of EVM for the specified TS/CC and its symbol number
MERRor	Amplitude error for the specified TS/CC
AMERRor	RMS value of amplitude error for the specified TS/CC
PMERRor	Peak amplitude error for the specified TS/CC and its symbol number
PERRor	Phase error for the specified TS/CC
APERRor	RMS value of phase error for the specified TS/CC
PPERRor	Peak phase error for the specified TS/CC and its symbol number
RHO	Value of waveform quality (r) for the specified TS/CC
FERRor	Frequency error for the specified TS
OOFFset	Value of origin offset for the specified TS/CC
STABLE	Data from symbol table for the specified TS/CC
TSNumber	Slot number in radio frame for the specified TS
SSCHannel	Secondary Synchronization Channel (SSCH) number for the specified TS
SCGRoup	Scrambling code group for the specified TS
SCNumber	Scrambling code number for the specified TS

Table 2-75: Queried information on the 3GPP-R5 downlink analysis results (Cont.)

Argument	Information queried
TLEnGth	Number of analyzed TSs
PCDE	PCDE (Peak Code Domain Error) for the specified TS, and the CC number
CEVM	RMS and peak values of chip EVM for the specified TS
CMERror	RMS and peak values of chip amplitude error for the specified TS
CPERror	RMS and peak values of chip phase error for the specified TS
CRHO	Chip waveform quality (r) for the specified TS
COOF	Chip origin offset for the specified TS

* **TS: Time slot, CC: Channelization code**

To specify the time slot, use the :DISPlay:DLR5_3GPP:AVIew:TSLot command. To specify the short code, use the :DISPlay:DLR5_3GPP:AVIew:SHORT-code command.

Returns Returns are listed below for each of the arguments:

CSHortcode. #<Num_digit><Num_byte><Cpwr(1)><Cpwr(2)>...<Cpwr(n)>

Where

<Num_digit> is the number of digits in <Num_byte>.

<Num_byte> is the number of bytes of data that follow.

<Cpwr(n)> is the relative or absolute power value for each short code in dB or dBm. 4-byte little endian floating-point format specified in IEEE 488.2.

n: Max 512

CCODE. #<Num_digit><Num_byte><Cpwr(1)><Cpwr(2)>...<Cpwr(n)>

Where

<Num_digit> is the number of digits in <Num_byte>.

<Num_byte> is the number of bytes of data that follow.

<Cpwr(n)> is the relative or absolute power value for each short code in dB or dBm. 4-byte little endian floating-point format specified in IEEE 488.2.

n: Max 512

CSYMBOL. #<Num_digit><Num_byte><Cpwr(1)><Cpwr(2)>...<Cpwr(n)>

Where

<Num_digit> is the number of digits in <Num_byte>.

<Num_byte> is the number of bytes of data that follow.

<Cpwr(n)> is the relative or absolute power value for each symbol in dB or dBm. 4-byte little endian floating-point format specified in IEEE 488.2.

n: Max 640

CTSLot. #<Num_digit><Num_byte><Cpwr(1)><Cpwr(2)>...<Cpwr(n)>

Where

<Num_digit> is the number of digits in <Num_byte>.

<Num_byte> is the number of bytes of data that follow.

<Cpwr(n)> is the relative or absolute power value for each time slot in dB or dBm. 4-byte little endian floating-point format specified in IEEE 488.2.

n: Max 16000

SCONste. #<Num_digit><Num_byte><Ip(1)><Qp(1)>...<Ip(n)><Qp(n)>

Where

<Num_digit> is the number of digits in <Num_byte>.

<Num_byte> is the number of bytes of data that follow.

<Ip(n)> is the symbol position on the I axis in volts.

<Qp(n)> is the symbol position on the Q axis in volts.

Both <Ip(1)> and <Qp(1)> are in the 4-byte little endian floating-point format specified in IEEE 488.2. n: Max 640.

EVM. #<Num_digit><Num_byte><Evm(1)><Evm(2)>...<Evm(n)>

Where

<Num_digit> is the number of digits in <Num_byte>.

<Num_byte> is the number of bytes of data that follow.

<Evm(n)> is the value of EVM of symbol in percent (%).

4-byte little endian floating-point format specified in IEEE 488.2

n: Max 640

AEVM. <aevm>::=<NRf> is the EVM RMS value in percent (%).

PEVM. <pevm>, <symb>

Where

<pevm>::=<NRf> is the EVM peak value in percent (%).

<symb>::=<NR1> is the symbol number for the EVM peak value.

MERRror. #<Num_digit><Num_byte><Merr(1)><Merr(2)>...<Merr(n)>

Where

<Num_digit> is the number of digits in <Num_byte>.

<Num_byte> is the number of bytes of data that follow.

<Merr(n)> is the value of amplitude error of symbol in percent (%).

4-byte little endian floating-point format specified in IEEE 488.2

n: Max 640

AMERror. <amer>::=<NRf> is the amplitude error RMS value in percent (%).

PMERror. <pmer>, <symb>

Where

<pmer>::=<NRf> is the amplitude error peak value in percent (%).

<symb>::=<NR1> is the symbol number for the amplitude error peak value.

PERRror. #<Num_digit><Num_byte><Perr(1)><Perr(2)>...<Perr(n)>

Where

<Num_digit> is the number of digits in <Num_byte>.

<Num_byte> is the number of bytes of data that follow.

<Perr(n)> is the value of phase error of symbol in degrees.

4-byte little endian floating-point format specified in IEEE 488.2

n: Max 640

APERror. <pmer>::=<NRf> is the phase error RMS value in degrees.

PPERror. <pmer>, <symb>

Where

<pmer>::=<NRf> is the phase error peak value in degrees.

<symb>::=<NRf> is the symbol number of phase error peak value.

RHO. <rho>::=<NRf> is the measured value of waveform quality.

FERRror. <ferr>::=<NRf> is the measured value of frequency error in Hz.

OOFFset. <ooff>::=<NRf> is the measured value of origin offset in dB.

STABLE. #<Num_digit><Num_byte><Sym(1)><Sym(2)>...<Sym(n)>

Where

<Num_digit> is the number of digits in <Num_byte>.

<Num_byte> is the number of bytes of data that follow.

<Sym(n)>::=<NR1> is the symbol data.

n: Max 640.

TSNumber. <tsnum>::=<NR1> is the slot number in radio frame.

SSCHannel. <ssch>::=<NR1> is the Secondary Synchronization Channel (SSCH) number.

SCGRoup. <scgr>::=<NR1> is the scrambling code group.

SCNumber. <scnum>::=<NR1> is the scrambling code number.

TLENgth. <tlen>::=<NR1> is the number of analyzed time slots.

PCDE. <pcde>, <scod>

Where

<pcde>::=<NRf> is the PCDE (Peak Code Domain Error) value in dB.

<scod>::=<NRf> is the short code number for the PCDE.

CEVM. <cevma>, <cevmp>

Where

<cevma>::=<NRf> is the RMS value of chip EVM in percent (%).

<cevmp>::=<NRf> is the peak value of chip EVM in percent (%).

CMERror. <cmera>, <cmerp>

Where

<cmera>::=<NRf> is the RMS value of chip amplitude error in percent (%).

<cmerp>::=<NRf> is the peak value of chip amplitude error in percent (%).

CPERror. <cpera>, <cperp>

Where

<cpera>::=<NRf> is the RMS value of chip phase error in percent (%).

<cperp>::=<NRf> is the peak value of chip phase error in percent (%).

CRHO. <crho>::=<NRf> is the chip waveform quality (ρ).

COOF. <coof>::=<NRf> is the chip origin offset in dB.

Measurement Modes DEMDLR5_3G

Examples :FETCh:DLR5_3GPP? CShortcode
might return #3512xxxx... (512-byte data) for the power measurement results for each short code.

Related Commands :DISPlay:DLR5_3GPP:AVIew:SHORtcode,
:DISPlay:DLR5_3GPP:AVIew:TSLot, :INSTrument[:SElect]

:FETCh:SADLR5_3GPP|:SAULR5_3GPP Subgroup

3GPP-R5 Analysis, Option 27 Only

The :FETCh:SADLR5_3GPP|:SAULR5_3GPP commands return the results of spectrum analysis for 3GPP-R5 downlink or uplink.

For the :FETCh:SADLR5_3GPP|:SAULR5_3GPP command subgroup, if you want to perform a FETCh operation on fresh data, use the :READ commands on page 3-59. The :READ commands acquire a new input signal and fetch the measurement results from the data

Command Tree	Header	Parameter
	:FETCh	
	:SADLR5_3GPP :SAULR5_3GPP	
	:ACLR?	
	:CFrequency?	
	:CHPower?	
	:EBWidth?	
	:MCAC1r?	
	:OBWidth?	
	:SEMask?	
	:SPECTrum?	
	:ACLR?	
	:CFrequency?	
	:CHPower?	
	:EBWidth?	
	:MCAC1r?	
	:OBWidth?	
	:SEMask?	

:FETCh:SADLR5_3GPP|SAULR5_3GPP:ACLR? (Query Only)

Returns the results of the ACLR (Adjacent Channel Leakage Power Ratio) measurement in the 3GPP-R5 analysis.

Syntax :FETCh:SADLR5_3GPP|SAULR5_3GPP:ACLR?

Arguments None

Returns <Pass_Fail><Chpower>,<Lac1r1>,<Uac1r1>,<Lac1r2>,<Uac1r2>

Where

<Pass_Fail>::={ 1 | -1 | 0 } is the limit test result.

1: Pass, -1: Fail, 0: No decision (measurement limits disabled).

<Chpower>::=<NRf> is the channel power measured value in dBm.

<Lac1r1>::=<NRf> is the 1st lower adjacent channel ACLR in dBc.

<Uac1r1>::=<NRf> is the 1st upper adjacent channel ACLR in dBc.

<Lac1r2>::=<NRf> is the 2nd lower adjacent channel ACLR in dBc.

<Uac1r2>::=<NRf> is the 2nd upper adjacent channel ACLR in dBc.

Invalid data is returned as -1000.

Measurement Modes SADLR5_3G, SAULR5_3G

Examples :FETCh:SADLR5_3GPP:ACLR?
might return 1,-18.17,59.35,56.83,57.88,58.52 for the ACLR measurement results.

Related Commands :INSTrument[:SElect]

:FETCh:SADLR5_3GPP|:SAULR5_3GPP:CFrequency? (Query Only)

Returns the results of the carrier frequency measurement in the 3GPP-R5 analysis.

Syntax :FETCh:SADLR5_3GPP|:SAULR5_3GPP:CFrequency?

Arguments None

Returns <Cfreq>::=<NRf> is the carrier frequency measured value in Hz.

Measurement Modes SADLR5_3G, SAULR5_3G

Examples :FETCh:SADLR5_3GPP:CFrequency?
might return 2.025E+9, indicating that the carrier frequency is 2.025 GHz.

Related Commands :INSTRument[:SElect]

:FETCh:SADLR5_3GPP|:SAULR5_3GPP:CHPower? (Query Only)

Returns the results of the channel power measurement in the 3GPP-R5 analysis.

Syntax :FETCh:SADLR5_3GPP|:SAULR5_3GPP:CHPower?

Arguments None

Returns <pass_fail>,<chpower>,<power_density>

Where

<pass_fail>::={ 1 | 0 } is the measurement result; 1: Pass or 0: Fail.

<chpower>::=<NRf> is the channel power measured value in dBm.

<power_density>::=<NRf> is the power density measured value in dBm/Hz.

<pass_fail> returns 1 (one) when the test is disabled.

Measurement Modes SADLR5_3G, SAULR5_3G

Examples :FETCh:SADLR5_3GPP:CHPower?
might return 1,-2.0375E+001,-8.1274E+001 for the channel power measurement.

Related Commands :INSTrument[:SElect]

:FETCh:SADLR5_3GPP|:SAULR5_3GPP:EBWidth? (Query Only)

Returns the results of the EBW (Emission Bandwidth) measurement in the 3GPP-R5 analysis.

Syntax :FETCh:SADLR5_3GPP|:SAULR5_3GPP:EBWidth?

Arguments None

Returns <ebw>::=<NRf> is the EBW in Hz.

Measurement Modes SADLR5_3G, SAULR5_3G

Examples :FETCh:SADLR5_3GPP:EBWidth?
might return 3.843E+6, indicating that the EBW is 3.843 MHz.

Related Commands :INSTRument[:SElect]

:FETCh:SADLR5_3GPP:MCAClr? (Query Only)

Returns the results of the multi-carrier ACLR (Adjacent Channel Leakage Power Ratio) measurement in the 3GPP-R5 downlink analysis.

Syntax :FETCh:SADLR5_3GPP:MCAClr?

Arguments None

Returns <Pass_Fail>,<Mainchannel_No>,<Totalpower>,
<Chpower1>,<Chpower2>,<Chpower3>,<Chpower4>,
<Lac1r1>,<Uac1r1>,<Lac1r2>,<Uac1r2>

Where

<Pass_Fail>::={ 1 | -1 | 0 } is the limit test result.

1: Pass, -1: Fail, 0: No decision (measurement limits disabled).

<Mainchannel_No>::=<NR1> is the number of main channels (1 to 4).

<Totalpower>::=<NRf> is the total power measured value in dBm.

<Chpower1>::=<NRf> is the power measured value for Channel 1 in dBm.

<Chpower2>::=<NRf> is the power measured value for Channel 2 in dBm.

<Chpower3>::=<NRf> is the power measured value for Channel 3 in dBm.

<Chpower4>::=<NRf> is the power measured value for Channel 4 in dBm.

<Lac1r1>::=<NRf> is the first lower adjacent channel ACLR in dBc.

<Uac1r1>::=<NRf> is the first upper adjacent channel ACLR in dBc.

<Lac1r2>::=<NRf> is the second lower adjacent channel ACLR in dBc.

<Uac1r2>::=<NRf> is the second upper adjacent channel ACLR in dBc.

Invalid data is returned as -1000.

Measurement Modes SADLR5_3G

Examples :FETCh:SADLR5_3GPP:MCAClr?
might return 1,4,-12.18,-18.14,-18.04,-18.16,-18.17,59.35,56.83,
57.88,58.52 for the multi-carrier ACLR measurement results.

Related Commands :INSTrument[:SELEct]

:FETCh:SADLR5_3GPP|:SAULR5_3GPP:OBWidth? (Query Only)

Returns the results of the OBW (Occupied Bandwidth) measurement in the 3GPP-R5 analysis.

Syntax :FETCh:SADLR5_3GPP|:SAULR5_3GPP:OBWidth?

Arguments None

Returns <pass_fail>,<obw>

Where

<pass_fail>::={ 1 | 0 } is the measurement result; 1: Pass or 0: Fail.

<obw>::=<NRf> is the occupied bandwidth in Hz.

<pass_fail> returns 1 (one) when the test is disabled.

Measurement Modes SADLR5_3G, SAULR5_3G

Examples :FETCh:SADLR5_3GPP:OBWidth?
might return 1,1.27333E+006 for the OBW measurement.

Related Commands :INSTRument[:SElect]

:FETCh:SADLR5_3GPP|:SAULR5_3GPP:SEMask? (Query Only)

Returns the results of the spectrum emission mask measurement in the 3GPP-R5 analysis.

Syntax :FETCh:SADLR5_3GPP|:SAULR5_3GPP:SEMask?

Arguments None

Returns <pass_fail>::={ 1 | 0 } is the measurement result; 1: Pass or 0: Fail.

Measurement Modes SADLR5_3G, SAULR5_3G

Examples :FETCh:SADLR5_3GPP:SEMask?
might return 1 for the spectrum emission mask measurement.

Related Commands :INSTrument[:SElect]

:FETCh:SADLR5_3GPP|:SAULR5_3GPP:SPECTrum:ACLR? (Query Only)

Returns the spectrum waveform data of the ACLR (Adjacent Channel Leakage Power Ratio) measurement in the 3GPP-R5 analysis.

Syntax :FETCh:SADLR5_3GPP|:SAULR5_3GPP:SPECTrum:ACLR?

Arguments None

Returns #<Num_digit><Num_byte><Data(1)><Data(2)>...<Data(n)>

Where

<Num_digit> is the number of digits in <Num_byte>.

<Num_byte> is the number of bytes of data that follow.

<Data(n)> is the spectrum amplitude in dBm.

Four-byte little endian floating-point format specified in IEEE 488.2.

n: Max 240001

Invalid data is returned as -1000.

Measurement Modes SADLR5_3G, SAULR5_3G

Examples :FETCh:SADLR5_3GPP:SPECTrum:ACLR?
might return #510240xxx... (10240-byte data) as the spectrum waveform data of the ACLR measurement.

Related Commands :INSTRument[:SElect]

:FETCh:SADLR5_3GPP|:SAULR5_3GPP:SPECTrum:CFRequency? (Query Only)

Returns the spectrum waveform data of the carrier frequency measurement in the 3GPP-R5 analysis.

Syntax :FETCh:SADLR5_3GPP|:SAULR5_3GPP:SPECTrum:CFRequency?

Arguments None

Returns #<Num_digit><Num_byte><Data(1)><Data(2)>...<Data(n)>

Where

<Num_digit> is the number of digits in <Num_byte>.

<Num_byte> is the number of bytes of data that follow.

<Data(n)> is the spectrum amplitude in dBm.

Four-byte little endian floating-point format specified in IEEE 488.2.

n: Max 240001

Invalid data is returned as -1000.

Measurement Modes SADLR5_3G, SAULR5_3G

Examples :FETCh:SADLR5_3GPP:SPECTrum:CFRequency?
might return #510240xxx... (10240-byte data) as the spectrum waveform data of the carrier frequency measurement.

Related Commands :INSTrument[:SElect]

:FETCh:SADLR5_3GPP|:SAULR5_3GPP:SPECTrum:CHPower? (Query Only)

Returns the spectrum waveform data of the channel power measurement in the 3GPP-R5 analysis.

Syntax :FETCh:SADLR5_3GPP|:SAULR5_3GPP:SPECTrum:CHPower?

Arguments None

Returns #<Num_digit><Num_byte><Data(1)><Data(2)>...<Data(n)>

Where

<Num_digit> is the number of digits in <Num_byte>.

<Num_byte> is the number of bytes of data that follow.

<Data(n)> is the spectrum amplitude in dBm.

Four-byte little endian floating-point format specified in IEEE 488.2.

n: Max 240001

Invalid data is returned as -1000.

Measurement Modes SADLR5_3G, SAULR5_3G

Examples :FETCh:SADLR5_3GPP:SPECTrum:CHPower?
might return #510240xxx... (10240-byte data) as the spectrum waveform data of the channel power measurement.

Related Commands :INSTRument[:SElect]

:FETCh:SADLR5_3GPP|SAULR5_3GPP:SPECTrum:EBWidth? (Query Only)

Returns the spectrum waveform data of the EBW (Emission Bandwidth) measurement in the 3GPP-R5 analysis.

Syntax :FETCh:SADLR5_3GPP|SAULR5_3GPP:SPECTrum:EBWidth?

Arguments None

Returns #<Num_digit><Num_byte><Data(1)><Data(2)>...<Data(n)>

Where

<Num_digit> is the number of digits in <Num_byte>.

<Num_byte> is the number of bytes of data that follow.

<Data(n)> is the spectrum amplitude in dBm.

Four-byte little endian floating-point format specified in IEEE 488.2.

n: Max 240001

Invalid data is returned as -1000.

Measurement Modes SADLR5_3G, SAULR5_3G

Examples :FETCh:SADLR5_3GPP:SPECTrum:EBWidth?
might return #510240xxx... (10240-byte data) as the spectrum waveform data of the EBW measurement.

Related Commands :INSTrument[:SElect]

:FETCh:SADLR5_3GPP:SPECTrum:MCAClr? (Query Only)

Returns the spectrum waveform data of the multi-carrier ACLR (Adjacent Channel Leakage Power Ratio) measurement in the 3GPP-R5 downlink analysis.

Syntax :FETCh:SADLR5_3GPP:SPECTrum:MCAClr?

Arguments None

Returns #<Num_digit><Num_byte><Data(1)><Data(2)>...<Data(n)>

Where

<Num_digit> is the number of digits in <Num_byte>.

<Num_byte> is the number of bytes of data that follow.

<Data(n)> is the spectrum amplitude in dBm.

Four-byte little endian floating-point format specified in IEEE 488.2.

n: Max 240001

Invalid data is returned as -1000.

Measurement Modes SADLR5_3G

Examples :FETCh:SADLR5_3GPP:SPECTrum:MCAClr?
might return #510240xxx... (10240-byte data) as the spectrum waveform data of the multi-carrier ACLR measurement.

Related Commands :INSTRument[:SElect]

:FETCh:SADLR5_3GPP|SAULR5_3GPP:SPECTrum:OBWidth? (Query Only)

Returns the spectrum waveform data of the OBW (Occupied Bandwidth) measurement in the 3GPP-R5 analysis.

Syntax :FETCh:SADLR5_3GPP|SAULR5_3GPP:SPECTrum:OBWidth?

Arguments None

Returns #<Num_digit><Num_byte><Data(1)><Data(2)>...<Data(n)>

Where

<Num_digit> is the number of digits in <Num_byte>.

<Num_byte> is the number of bytes of data that follow.

<Data(n)> is the spectrum amplitude in dBm.

Four-byte little endian floating-point format specified in IEEE 488.2.

n: Max 240001

Invalid data is returned as -1000.

Measurement Modes SADLR5_3G, SAULR5_3G

Examples :FETCh:SADLR5_3GPP:SPECTrum:OBWidth?
might return #510240xxx... (10240-byte data) as the spectrum waveform data of the OBW measurement.

Related Commands :INSTrument[:SElect]

:FETCh:SADLR5_3GPP|:SAULR5_3GPP:SPECTrum:SEMAsk? (Query Only)

Returns the spectrum waveform data of the spectrum emission mask measurement in the 3GPP-R5 analysis.

Syntax :FETCh:SADLR5_3GPP|:SAULR5_3GPP:SPECTrum:SEMAsk?

Arguments None

Returns #<Num_digit><Num_byte><Data(1)><Data(2)>...<Data(n)>

Where

<Num_digit> is the number of digits in <Num_byte>.

<Num_byte> is the number of bytes of data that follow.

<Data(n)> is the spectrum amplitude in dBm.

Four-byte little endian floating-point format specified in IEEE 488.2.

n: Max 240001

Invalid data is returned as -1000.

Measurement Modes SADLR5_3G, SAULR5_3G

Examples :FETCh:SADLR5_3GPP:SPECTrum:SEMAsk?
might return #510240xxx... (10240-byte data) as the spectrum waveform data of the spectrum emission mask measurement.

Related Commands :INSTRument[:SElect]

:FETCh:ULR5_3GPP Subgroup***SADLR5_3GPP Analysis, Option 27 Only***

The :FETCh:ULR5_3GPP commands return the measurement results of the 3GPP-R5 uplink modulation analysis.

For the :FETCh:ULR5_3GPP command subgroups, if you want to perform a FETCh operation on fresh data, use the [:SENSE]:ULR5_3GPP[:IMMEDIATE] command.

Command Tree**Header****Parameter**

:FETCh

:ULR5_3GPP?

ANACK | CNUMBER | CSYMBOL | CTSLOT | SCNSTE
 | EVM | AEVM | PEVM | MERROR | AMERROR
 | PERROR | PERROR | APERROR | PPEROR
 | RHO | FERROR | OOFFSET | STABLE | TSNUMBER
 | TLENGTH | PCDE | CEVM | CMERROR | CPEROR
 | CHRO | COOF | SIGNATURE | PREAMBLE

:FETCh:ULR5_3GPP? (Query Only)

Returns measurement results of the 3GPP-R5 uplink analysis.

Syntax :FETCh:ULR5_3GPP? { ANACK | CNUmber | CSYMBOL | CTSLot | SCOnste
| EVM | AEVM | PEVM | MERRor | AMERRor | PMERRor | PERRor
| APERRor | PPERror | RHO | FERRor | OOFFset | STABle | TSNUmber
| TLENgth | PCDE | CEVM | CMERRor | CPERror | CHRO | COOF
| SIGNature | PREamble }

Arguments Information queried is listed below for each of the arguments.

Table 2-76: Queried information on the 3GPP-R5 uplink analysis results

Argument	Information queried
ANACK	ACK/NACK for the specified TS
CNUmber	Power of each channelization code for the specified TS
CSYMBOL	Each symbol power of the specified TS/CN
CTSLot	Power of each time slot for the specified CN
SCOnste	Symbol position data for the specified TS/CN
EVM	Measurement results of Error Vector Magnitude for the specified TS/CN
AEVM	RMS value of EVM for the specified TS/CN
PEVM	Peak value of EVM for the specified TS/CN and its symbol number
MERRor	Amplitude error for the specified TS/CN
AMERRor	RMS value of amplitude error for the specified TS/CN
PMERRor	Peak amplitude error for the specified TS/CN and its symbol number
PERRor	Phase error for the specified TS/CN
APERRor	RMS value of phase error for the specified TS/CN
PPERror	Peak phase error for the specified TS/CN and its symbol number
RHO	Value of waveform quality (r) for the specified TS/CN
FERRor	Frequency error for the specified TS
OOFFset	Value of origin offset for the specified TS/CN
STABle	Data from symbol table for the specified TS/CN
TSNUmber	Slot number in radio frame for the specified TS
TLENgth	Number of analyzed TSs
PCDE	PCDE (Peak Code Domain Error) for the specified TS, and the CN
CEVM	RMS and peak values of chip EVM for the specified TS

CNUMber. #<Num_digit><Num_byte><Cpwr(1)><Cpwr(2)>...<Cpwr(n)>

Where

<Num_digit> is the number of digits in <Num_byte>.

<Num_byte> is the number of bytes of data that follow.

<Cpwr(n)> is the relative or absolute power value for each short code in dB or dBm. 4-byte little endian floating-point format specified in IEEE 488.2.

n: Max 512

CSYMBOL. #<Num_digit><Num_byte><Cpwr(1)><Cpwr(2)>...<Cpwr(n)>

Where

<Num_digit> is the number of digits in <Num_byte>.

<Num_byte> is the number of bytes of data that follow.

<Cpwr(n)> is the relative or absolute power value for each symbol in dB or dBm. 4-byte little endian floating-point format specified in IEEE 488.2.

n: Max 640

CTSLot. #<Num_digit><Num_byte><Cpwr(1)><Cpwr(2)>...<Cpwr(n)>

Where

<Num_digit> is the number of digits in <Num_byte>.

<Num_byte> is the number of bytes of data that follow.

<Cpwr(n)> is the relative or absolute power value for each time slot in dB or dBm. 4-byte little endian floating-point format specified in IEEE 488.2.

n: Max 16000

SCONste. #<Num_digit><Num_byte><Ip(1)><Qp(1)>...<Ip(n)><Qp(n)>

Where

<Num_digit> is the number of digits in <Num_byte>.

<Num_byte> is the number of bytes of data that follow.

<Ip(n)> is the symbol position on the I axis in volts.

<Qp(n)> is the symbol position on the Q axis in volts.

Both <Ip(1)> and <Qp(1)> are in the 4-byte little endian floating-point format specified in IEEE 488.2. n: Max 640.

EVM. #<Num_digit><Num_byte><Evm(1)><Evm(2)>...<Evm(n)>

Where

<Num_digit> is the number of digits in <Num_byte>.

<Num_byte> is the number of bytes of data that follow.

<Evm(n)> is the value of EVM of symbol in percent (%).

4-byte little endian floating-point format specified in IEEE 488.2

n: Max 640

AEVM. <aevm>::=<NRf> is the EVM RMS value in percent (%).

PEVM. <pevm>, <symb>

Where

<pevm>::=<NRf> is the EVM peak value in percent (%).

<symb>::=<NR1> is the symbol number for the EVM peak value.

MERRor. #<Num_digit><Num_byte><Merr(1)><Merr(2)>...<Merr(n)>

Where

<Num_digit> is the number of digits in <Num_byte>.

<Num_byte> is the number of bytes of data that follow.

<Merr(n)> is the value of amplitude error of symbol in percent (%).

4-byte little endian floating-point format specified in IEEE 488.2

n: Max 640

AMERror. <amer>::=<NRf> is the amplitude error RMS value in percent (%).

PMERror. <pmer>, <symb>

Where

<pmer>::=<NRf> is the amplitude error peak value in percent (%).

<symb>::=<NR1> is the symbol number for the amplitude error peak value.

PERRror. #<Num_digit><Num_byte><Perr(1)><Perr(2)>...<Perr(n)>

Where

<Num_digit> is the number of digits in <Num_byte>.

<Num_byte> is the number of bytes of data that follow.

<Perr(n)> is the value of phase error of symbol in degrees.

4-byte little endian floating-point format specified in IEEE 488.2

n: Max 640

APERror. <pmer>::=<NRf> is the phase error RMS value in degrees.

PPERror. <pmer>, <symb>

Where

<pmer>::=<NRf> is the phase error peak value in degrees.

<symb>::=<NRf> is the symbol number of phase error peak value.

RHO. <rho>::=<NRf> is the measured value of waveform quality.

FERRror. <ferr>::=<NRf> is the measured value of frequency error in Hz.

OOFfset. <ooff>::=<NRf> is the measured value of origin offset in dB.

STABLE. #<Num_digit><Num_byte><Sym(1)><Sym(2)>...<Sym(n)>

Where

<Num_digit> is the number of digits in <Num_byte>.

<Num_byte> is the number of bytes of data that follow.

<Sym(n)>::=<NR1> is the symbol data.

n: Max 640.

TSNumber. <tsnum>::=<NR1> is the slot number in radio frame.

TLEnGth. <tlen>::=<NR1> is the number of analyzed time slots.

PCDE. <pcde>,<scod>

Where

<pcde>::=<NRf> is the PCDE (Peak Code Domain Error) value in dB.

<scod>::=<NRf> is the short code number for the PCDE.

CEVM. <cevma>,<cevmp>

Where

<cevma>::=<NRf> is the RMS value of chip EVM in percent (%).

<cevmp>::=<NRf> is the peak value of chip EVM in percent (%).

CMERror. <cmera>,<cmerp>

Where

<cmera>::=<NRf> is the RMS value of chip amplitude error in percent (%).

<cmerp>::=<NRf> is the peak value of chip amplitude error in percent (%).

CPERror. <cpera>,<cperp>

Where

<cpera>::=<NRf> is the RMS value of chip phase error in percent (%).

<cperp>::=<NRf> is the peak value of chip phase error in percent (%).

CRHO. <crho>::=<NRf> is the chip waveform quality (ρ).

COOF. <coof>::=<NRf> is the chip origin offset in dB.

SIGNatute. <sig>::=<NR1> is the signature number in the preamble.

PREamble. <pre>::=<NR1> is the preamble.

Measurement Modes DEMULR5_3G

Examples :FETCh:ULR5_3GPP? ANACK
might return 1,1,7,5 as the result of the ACK/NACK analysis.

Related Commands :INSTrument[:SELEct], [:SENSE]:ULR5_3GPP:SFRame:SEARCh

:FETCh:TD_SCDMA Subgroup***TD-SCDMA Analysis, Option 28 Only***

The :FETCh:TD_SCDMA commands return the results of the TD-SCDMA analysis.

Command Tree	Header	Parameter
	:FETCh	
	:TD_SCDMA	
	:ACLR?	
	:CDPower?	RESult CDPower
	:CHPower?	
	:IM?	
	:MACCuracy?	RESult MACCuracy SCONste EVM MERRor PERRor
	:OBWidth?	
	:SEMask?	
	:SFSummary?	
	:STABle?	
	:TOOMask?	
	:TSSummary?	
	:SPECTrum	
	:ACLR?	
	:CHPower?	
	:IM?	
	:OBWidth?	
	:SEMask?	
	:TAMPliitude	
	:SFSummary?	
	:TOOMask?	
	:TSSummary?	

:FETCh:TD_SCDMA:ACLR? (Query Only)

Returns the results of the adjacent channel leakage power ratio measurement under the TD-SCDMA standard.

Syntax :FETCh:TD_SCDMA:ACLR?

Arguments None

Returns <Pass_fail>,<Chpower>, or
<Pass_fail>,<Chpower>,<L_Aclr1>,<U_Aclr1>, or
<Pass_fail>,<Chpower>,<L_Aclr1>,<U_Aclr1>,<L_Aclr2>,<U_Aclr2>

Where

<Pass_fail>::={1|0} is the measurement result; 1: Pass or 0: Fail.

<Chpower>::=<NRf> is the channel power measured value in dBm.

<L_Aclr1>::=<NRf> is the first lower adjacent channel ACLR in dBc.

<U_Aclr1>::=<NRf> is the first upper adjacent channel ACLR in dBc.

<L_Aclr2>::=<NRf> is the second lower adjacent channel ACLR in dBc.

<U_Aclr2>::=<NRf> is the second upper adjacent channel ACLR in dBc.

Measurement Modes DEMTD_SCDMA

Example :FETCh:TD_SCDMA:ACLR?
might return 0,--2.045E+001,--6.461E+001,--4.379E+001,--6.576E+001,
--6.753E+001 for the ACLR measurement under the TD-SCDMA standard.

Related Commands :INSTrument[:SElect]

:FETCh:TD_SCDMA:CDPower? (Query Only)

Returns the results of the code domain power measurement under the TD-SCDMA standard.

NOTE. *There is no :READ subsystem for the :CDPower command.*

The command [:SENSe]:TD_SCDMA[:IMMEDIATE] must be executed in order to retrieve the measurement results.

Syntax :FETCh:TD_SCDMA:CDPower? { RESult | CDPower | CVSFrame
| CVSYmbol }

Arguments RESult: Measurement result.
CDPower: Relative/absolute power values of each code in a timeslot.
CVSFrame: Relative(dB)/Absolute(dBm) Power value of each selected code in each subframe.
CVSYmbol: Relative(dB)/Absolute(dBm) Power value of each code in each selected symbol.

Returns **RESult:**
<Pass_Fail>,<Peak_CD>,<Peak_CD_Code>,<Peak_ACD>,<Peak_ACD_Code>,
<CD_Error>,<CD_Error_Code>,<No_AC>

Where

<Pass_fail>::={1|0} is the measurement result; 1: Pass or 0: Fail.

<Peak_CD>::=<NRf> is the peak code domain error value in dBm.

<Peak_CD_Code>::=<NRf> is the peak code domain error code.

<Peak_ACD>::=<NRf> is the peak active channel code domain error value in dBm.

<Peak_ACD_Code>::=<NRf> is the peak active channel code.

<CD_Error>::=<NRf> is the code domain error value dB/dBm.

<CD_Error_Code>::=<NR1> is the code domain error code.

<No_AC>::=<NR1> is the number of active codes.

CDPower:

#<Num_digit>,<Num_byte>,<Cpower(0)>,<Cpower(1)>,...,
<Cpower(n-1)>,<Cpower(n)>

Where

<Num_digit> is the number of digits in <Num_byte>.

<Num_byte> is the number of bytes of data that follows.

<Cpower(n)> is the relative(dB)/Absolute(dBm) power value of each code.

When the unit on the Y of main view is set to RELative, selects Relative power value. When the unit on the Y of main view is set to ABSolute, selects Absolute power value.

4-byte little endian floating-point format specified in IEEE 488.2.

n ::= Max 15

CVSFrame:

#<Num_digit>,<Num_byte>,<SFPower(0)>,<SFPower(1)>,...,
<SFPower(n-1)>,<SFPower(n)>

Where

<Num_digit> is the number of digits in <Num_byte>.

<Num_byte> is the number of bytes of data that follows.

<SFPower(n)> is the relative(dB)/Absolute(dBm) power value of each code in each subframe.

When the unit on the Y of main view is set to RELative, selects Relative power value. When the unit on the Y of main view is set to ABSolute, selects Absolute power value.

4-byte little endian floating-point format specified in IEEE 488.2.

n ::= Max 2048

CVSYmbol:

#<Num_digit>,<Num_byte>,<SYPower(0)>,<SYPower(1)>,...,
<SYPower(n-1)>,<SYPower(n)>

Where

<Num_digit> is the number of digits in <Num_byte>.

<Num_byte> is the number of bytes of data that follows.

<SYPower(n)> is the relative(dB)/Absolute(dBm) power value of each symbol.

When the unit on the Y of main view is set to RELative, selects Relative power value. When the unit on the Y of main view is set to ABSolute, selects Absolute power value.

4-byte little endian floating-point format specified in IEEE 488.2.

n ::= Max 704

Measurement Modes

DEMTD_SCDMA

Example :FETCh:TD_SCDMA:CDPower? RESult
might return #1,-4.3042E+001,0,-4.3042E+001,0,-4.3042E+001,0,2 as the results of the code domain power measurement of the TD-SCDMA standard.

Related Commands :INSTrument[:SElect]

:FETCh:TD_SCDMA:CHPower? (Query Only)

Returns the results of the channel power measurement under the TD-SCDMA standard.

Syntax :FETCh:TD_SCDMA:CHPower?

Arguments None

Returns <Pass_fail>,<chpower>,<power_density>

Where

<Pass_fail>::={ 1 | 0 } is the measurement result; 1: Pass or 0: Fail.

<Chpower>::=<NRf> is the channel power measured value in dBm.

<Power_density>::=<NRf> is the power density measured value in dBm/Hz.

Measurement Modes DEMTD_SCDMA

Example :FETCh:TD_SCDMA:CHPower?
might return 1,--2.0339E+001,--8.1238E+001 for the channel power measurement under the TD-SCDMA standard.

Related Commands :INSTrument[:SElect]

:FETCh:TD_SCDMA:IM? (Query Only)

Returns the results of the intermodulation measurement under the TD-SCDMA standard.

Syntax :FETCh:TD_SCDMA:IM?

Arguments None

Returns <Pass_fail>,<L_channel>,<U_channel>,<L3_lower>,<L3_upper>,<U3_lower>,<U3_upper>,<L5_lower>,<L5_upper>,<U5_lower>,<U5_upper>

Where

<Pass_fail>::={1|0} is the measurement result; 1: Pass or 0: Fail.
<L_channel>::=<NRf> is the lower channel measured value in dBm.
<U_channel>::=<NRf> is the upper channel measured value in dBm.
<L3_lower>::=<NRf> is the lower third order (lower) measured value in dBc.
<L3_upper>::=<NRf> is the lower third order (upper) measured value in dBc.
<U3_lower>::=<NRf> is the upper third order (lower) measured value in dBc.
<U3_upper>::=<NRf> is the upper third order (upper) measured value in dBc.
<L5_lower>::=<NRf> is the lower fifth order (lower) measured value in dBc.
<L5_upper>::=<NRf> is the lower fifth order (upper) measured value in dBc.
<U5_lower>::=<NRf> is the upper fifth order (lower) measured value in dBc.
<U5_upper>::=<NRf> is the upper fifth order (upper) measured value in dBc.

When each value is not present, the value of -1000 is returned.

Measurement Modes DEMTD_SCDMA

Example :FETCh:TD_SCDMA:IM?
might return 1,--2.061E+001,--5.501E+001,--1.66E+001,1.78E+001,--4.76E+001,--1.32E+001,--4.73E+001,--1.29E+001,--5.1E+001,--1.66E+001 for the intermodulation measurement under the TD-SCDMA standard.

Related Commands :INSTrument[:SELect]

:FETCh:TD_SCDMA:MACCuracy? (Query Only)

Returns the results of the modulation accuracy measurement under the TD-SCDMA standard.

NOTE. *There is no :READ subsystem for the :MACCuracy command.*

The command [:SENSe]:TD_SCDMA[:IMMEDIATE] must be executed in order to retrieve the measurement results.

Syntax :FETCh:TD_SCDMA:MACCuracy? { RESult | MACCuracy | SCONste | EVM | MERRor | PERRor }

Arguments

RESult	measurement result
MACCuracy	I/Q position of each symbol
SCONste	Symbol constellation
EVM	EVM of each symbol
MERRor	magnitude error of each symbol
PERRor	phase error of each symbol

Returns **RESult:**
 <Pass_Fail>,<SEVM_Peak>,<SEVM_Peak>,<CEVM_Peak>,<CEVM_RMS>,
 <Crho>,<CMerror_Peak>,<CMerror_RMS>,<CPerror_Peak>,<CPerror_RMS>,
 <Ferror>,<IQ_Imbalance>,<IQ_Offset >

Where

<Pass_fail>::={ 1 | 0 } is the measurement result; 1: Pass or 0: Fail.

<SEVM_Peak>::=<NRf> Symbol Peak EVM (%)

<SEVM_Peak>::=<NRf> Symbol Peak EVM (%)

<CEVM_Peak>::=<NRf> Composite Peak EVM (%)

<CEVM_RMS>::=<NRf> Composite RMS EVM (%)

<Crho>::=<NRf> Composite Rho

<CMerror_Peak>::=<NRf> Composite Peak Magnitude Error (%)

<CMerror_RMS>::=<NRf> Composite RMS Magnitude Error (%)

<CPerror_Peak>::=<NRf> Composite Peak Phase Error (deg)

<CPerror_RMS>::=<NRf> Composite RMS Phase Error (deg)

<Ferror>::=<NRf> Frequency Error (Hz)

<IQ_Imbalance>::=<NRf> IQ Imbalance (dB)

<IQ_Offset >::=<NRf> IQ Offset (dB)

MACCuracy:

#<Num_digit>,<Num_byte>,<Iposition(1)>,<Qposition(1)>,...,
<Iposition(n)>,<Qposition(n)>

Where

<Num_digit> is the number of digits in <Num_byte>.

<Num_byte> is the number of bytes of data that follows.

<Iposition(n)> and <Qposition(n)> is the I/Q position of each symbol.

Four-byte little endian floating-point format specified in IEEE 488.2.

Measurement level:

Chip: n=Max 848

SCONste:

#<Num_digit>,<Num_byte>,<Iposition(1)>,<Qposition(1)>,...,
<Iposition(n)>,<Qposition(n)>

Where

<Num_digit> is the number of digits in <Num_byte>.

<Num_byte> is the number of bytes of data that follows.

<Iposition(n)> and <Qposition(n)> is the I/Q position of each symbol.

Four-byte little endian floating-point format specified in IEEE 488.2.

Measurement level:

Chip: n=Max 704

EVM:

#<Num_digit>,<Num_byte>,<EVM(1)>,...,<EVM(n)>

Where

<Num_digit> is the number of digits in <Num_byte>.

<Num_byte> is the number of bytes of data that follows.

<EVM(n)> is EVM of each symbol.

Four-byte little endian floating-point format specified in IEEE 488.2.

Measurement level:

Chip: n=Max 704

MERRor:

#<Num_digit>,<Num_byte>,<Merror(1)>,...,<Merror(n)>

Where

<Num_digit> is the number of digits in <Num_byte>.

<Num_byte> is the number of bytes of data that follows.

<Merror(n)> is the magnitude error of each symbol.

Four-byte little endian floating-point format specified in IEEE 488.2.

Measurement level:

Chip: n=Max 704

PERRor:

```
#<Num_digit>,<Num_byte>,<Perror(1)>,...,<Perror(n)>
```

Where

<Num_digit> is the number of digits in <Num_byte>.

<Num_byte> is the number of bytes of data that follows.

<Perror(n)> is the phase error of each symbol.

Four-byte little endian floating-point format specified in IEEE 488.2.

Measurement level:

Chip: n=Max 704

Measurement Modes DEMTD_SCDMA

Example

```
:FETCh:TD_SCDMA:MACCuracy? RESult
```

might return #1,3.8261E+000,2.02853E+000,4.36361E+000,2.06348E+000,
9.99574E-001,3.51029E+000,1.46589E+000,1.75665E+002,7.40321E+001,
-5.56065E+001,4.77605E-002,-3.59144E+001 as the results of the modula-
tion accuracy measurement of the TD-SCDMA measurement.

Related Commands :INSTrument[:SElect]

:FETCh:TD_SCDMA:OBWidth? (Query Only)

Fetches the results of the occupied bandwidth measurement under the TD-SCDMA standard.

Syntax :FETCh:TD_SCDMA:OBWidth?

Arguments None

Returns <Pass_fail>,<obw>

Where

<Pass_fail>::={ 1 | 0 } is the measurement result; 1: Pass or 0: Fail.

<obw>::=<NRf> is the occupied bandwidth in Hz.

Measurement Modes DEMTD_SCDMA

Example :FETCh:TD_SCDMA:OBWidth?
might return 1,1.27333E+006 for the OBW measurement under the TD-SCDMA standard.

Related Commands :INSTrument[:SElect]

:FETCh:TD_SCDMA:SEMask? (Query Only)

Fetches the results of the spectrum emission mask measurement under the TD-SCDMA standard.

Syntax :FETCh:TD_SCDMA:SEMask?

Arguments None

Returns <Pass_fail>

Where

<Pass_fail> ::= { 1 | 0 } is the measurement result; 1: Pass or 0: Fail.

Measurement Modes DEMTD_SCDMA

Example :FETCh:TD_SCDMA:SEMask?
might return 1, indicating that the spectrum emission mask measurement has passed.

Related Commands :INSTrument[:SElect]

:FETCh:TD_SCDMA:SFSummary? (Query Only)

Fetches the results of the subframe summary measurement under the TD-SCDMA standard.

NOTE. There is no :READ subsystem for the :SFSummary command.

Syntax :FETCh:TD_SCDMA:SFSummary?

Arguments None

Returns <Sync_DL>,<Sync_UL>,<Scrambling_Code>,< Switching_Point>,
<DwPts_Pattern>,<Multiframe_Position>,<DwPts_RMS_Power>,
<UpPts_RMS_Power>,<GP_RMS_Power>

Where

<Sync_DL>::=<NR1> Downlink Pilot (Sync DL)

<Sync_UL>::=<NR1> Uplink Pilot (Sync UL)

<Scrambling_Code>::=<NR1> Scrambling Code

<Switching_Point>::=<NR1> Switching Point

<DwPts_Pattern>::=<NR1> DwPts Pattern

<Multiframe_Position>::=<NR1> Multiframe Position

<DwPts_RMS_Power>::=<NRf> Downlink Pilot RMS Power (dBm)

<UpPts_RMS_Power>::=<NRf> Uplink Pilot RMS Power (dBm)

<GP_RMS_Power>::=<NRf> Gaurd Period RMS Power (dBm)

Measurement Modes DEMTD_SCDMA

Example :FETCh:TD_SCDMA:SFSummary?
might return #0,-1000,0,3,2,2,-1.71901E+001,-5.31588E+001,
-5.27454E+001 as the results of the subframe summary measurement under the
TD-SCDMA standard.

Related Commands :INSTrument[:SElect]

:FETCh:TD_SCDMA:STABle? (Query Only)

Fetches the results of the symbol table measurement under the TD-SCDMA standard.

Syntax :FETCh:TD_SCDMA:STABle?

Arguments None

Returns #<Num_digit><Num_byte><sym(1)>...<Sym(n)>

Where

<Num_digit> is the number of digits in <Num_byte>.

<Num_byte> is the number of bytes of data that follows.

<Sym(n)> Symbol Data.

<NR1>

n ::= MAX 704

Measurement Modes DEMTD_SCDMA

Example :FETCh:TD_SCDMA:STABle?
might return #3176xxx... (176-bytes of integer data) as Data1+Data2 symbols for the currently selected OVSF16 code in the symbol table measurement of the TD-SCDMA standard.

Related Commands :INSTrument[:SElect]

:FETCh:TD_SCDMA:TOOMask? (Query Only)

Fetches the results of the transmit on/off mask measurement under the TD-SCDMA standard.

Syntax :FETCh:TD_SCDMA:TOOMask?

Arguments None

Returns <Pass_Fail>,<Tx_Direction>,<Mid_Ramp_Max_Power>,<chip_offset1>,<Tx_Off_Max_Power><chip_offset2>

Where

<Pass_fail>::={ 1 | 0 } is the measurement result; 1: Pass or 0: Fail.

<Tx_Direction>::={ 1 | 0 } 0: Uplink or 1: Downlink

<Mid_Ramp_Max_Power>::=<NRf> Tx ON(uplink)/OFF(downlink) Mid-ramp region Maximum power (dBm)

<chip_offset1>::=<NR1> Chip offset at <Mid_Ramp_Max_Power>

<Tx_Off_Max_Power>::=<NRf> Tx OFF region Maximum power (dBm)

<chip_offset2>::=<NR1> Chip offset at <Tx_Off_Max_Power>

Measurement Modes DEMTD_SCDMA

Example :FETCh:TD_SCDMA:TOOMask?
might return #0,1,-5.25502E+001,1047,-1.20229E+001,1822 as the results of the transmit on/off mask measurement under the TD-SCDMA standard

Related Commands :INSTrument[:SElect]

:FETCh:TD_SCDMA:TSSummary? (Query Only)

Fetches the results of the timeslot summary measurement under the TD-SCDMA standard.

Syntax :FETCh:TD_SCDMA:TSSummary?

Arguments None

Returns <Pass_Fail>,<Terror>,<D1_Power>,<D2_Power>,<Mid_Power>,
<AverageBurst_Power>,<Count_of_K_Value>,
<K1>{,<K2>{,<K3>{,<K4>{,<K5>{,<K6>{,<K7>{,<K8>}}}}}}}

Where

<Pass_fail>::={ 1 | 0 } is the measurement result; 1: Pass or 0: Fail.

<Terror>::=<NRf> Timing Error (chips)

<D1_Power>::=<NRf> Data1 Power (dBm)

<D2_Power>::=<NRf> Data2 Power (dBm)

<Mid_Power>::=<NRf> Midamble Power (dBm)

<AverageBurst_Power>::=<NRf> Average burst RF Power of the timeslot (dBm)

<Count_of_K_Value>::=<NR1> Count of K value (1 to 8)

<Kn>::=<NR1> Kn (n::= 1 to 8)

Measurement Modes DEMTD_SCDMA

Example :FETCh:TD_SCDMA:TSSummary?
might return #1,0.0E+000,-1.71653E+001,-1.71807E+001,-1.71609E+001,
-1.72521E+001,2,10,16 as the results from the timeslot summary measurement under the TD-SCDMA standard.

Related Commands :INSTrument[:SElect]

:FETCh:TD_SCDMA:SPECTrum:ACLR? (Query Only)

Returns the results of the adjacent channel leakage power ratio measurement under the TD-SCDMA standard.

Syntax :FETCh:TD_SCDMA:SPECTrum:ACLR?

Arguments None

Returns #<Num_digit><Num_byte><Data(1)><Data(2)>...<Data(n)>

Where

<Num_digit> is the number of digits in <Num_byte>.

<Num_byte> is the number of bytes of data that follow.

<Data(n)> is the spectrum amplitude in dBm.

Four-byte little endian floating-point format specified in IEEE 488.2.

n: Max 240001

Measurement Modes DEMTD_SCDMA

Example :FETCh:TD_SCDMA:SPECTrum:ACLR?
might return #510240xxx... (10240-bytes of floating point data) as the spectrum waveform data of the ACLR measurement under the TD-SCDMA standard.

Related Commands :INSTrument[:SElect]

:FETCh:TD_SCDMA:SPECTrum:CHPower? (Query Only)

Fetches the spectrum waveform data of the channel power measurement under the TD-SCDMA standard.

Syntax :FETCh:TD_SCDMA:SPECTrum:CHPower?

Arguments None

Returns #<Num_digit><Num_byte><Data(1)><Data(2)>...<Data(n)>

Where

<Num_digit> is the number of digits in <Num_byte>.

<Num_byte> is the number of bytes of data that follow.

<Data(n)> is the spectrum amplitude in dBm.

Four-byte little endian floating-point format specified in IEEE 488.2.

n: Max 240001

Measurement Modes DEMTD_SCDMA

Example :FETCh:TD_SCDMA:SPECTrum:CHPower?
might return #510240xxx... (10240-bytes of floating point data) as the spectrum waveform data of the channel power measurement under the TD-SCDMA standard.

Related Commands :INSTrument[:SElect]

:FETCh:TD_SCDMA:SPECTrum:IM? (Query Only)

Fetches the spectrum waveform data of the intermodulation measurement under the TD-SCDMA standard.

Syntax :FETCh:TD_SCDMA:SPECTrum:IM?

Arguments None

Returns #<Num_digit><Num_byte><Data(1)><Data(2)>...<Data(n)>

Where

<Num_digit> is the number of digits in <Num_byte>.

<Num_byte> is the number of bytes of data that follow.

<Data(n)> is the spectrum amplitude in dBm.

Four-byte little endian floating-point format specified in IEEE 488.2.

n: Max 240001.

Invalid data is returned as -1000.

Measurement Modes DEMTD_SCDMA

Example :FETCh:TD_SCDMA:SPECTrum:IM?
might return #510240xxx... (10240-bytes of floating point data) as the spectrum waveform data of the intermodulation measurement under the TD_SCDMA.

Related Commands :INSTrument[:SELEct]

:FETCh:TD_SCDMA:SPECTrum:OBWidth? (Query Only)

Fetches the spectrum waveform data of the occupied bandwidth measurement under the TD-SCDMA standard.

Syntax :FETCh:TD_SCDMA:SPECTrum:OBWidth?

Arguments None

Returns #<Num_digit><Num_byte><Data(1)><Data(2)>...<Data(n)>

Where

<Num_digit> is the number of digits in <Num_byte>.

<Num_byte> is the number of bytes of data that follow.

<Data(n)> is the spectrum amplitude in dBm.

Four-byte little endian floating-point format specified in IEEE 488.2.

n: Max 240001.

Invalid data is returned as -1000.

Measurement Modes DEMTD_SCDMA

Example :FETCh:TD_SCDMA:SPECTrum:OBWidth?
might return #510240xxx... (10240-bytes of floating point data) as the spectrum waveform data of the occupied bandwidth measurement under the TD-SCDMA standard.

Related Commands :INSTrument[:SELEct]

:FETCh:TD_SCDMA:SPECTrum:SEMask? (Query Only)

Fetches the spectrum waveform data of the spectrum emission mask measurement under the TD-SCDMA standard.

Syntax :FETCh:TD_SCDMA:SPECTrum:SEMask?

Arguments None

Returns #<Num_digit><Num_byte><Data(1)><Data(2)>...<Data(n)>

Where

<Num_digit> is the number of digits in <Num_byte>.

<Num_byte> is the number of bytes of data that follow.

<Data(n)> is the spectrum amplitude in dBm.

Four-byte little endian floating-point format specified in IEEE 488.2.

n: Max 240001

Invalid data is returned as -1000.

Measurement Modes DEMTD_SCDMA

Example :FETCh:TD_SCDMA:SPECTrum:SEMask?
might return #510240xxx... (10240-bytes of floating point data) as the spectrum waveform data of the spectrum emissions mask measurement under the TD-SCDMA standard.

Related Commands :INSTrument[:SElect]

:FETCh:TD_SCDMA:TAMPlitude:SFSummary? (Query Only)

Fetches the results of the time domain amplitude data of the subframe summary measurement under the TD-SCDMA standard.

NOTE. *There is no :READ subsystem for the TAMPlitude commands.*

Syntax :FETCh:TD_SCDMA:TAMPlitude:SFSummary?

Arguments None

Returns #<Num_digit><Num_byte><Data1(1)><Data1(2)>...<Data(n)>
 Where
 <Num_digit> is the number of digits in <Num_byte>.
 <Num_byte> is the number of bytes of data that follows.
 <Data(n)> is the absolute power for each symbol in dBm. 4-Four-byte little
 endian floating-point format specified in IEEE 488.2.

Measurement level:

n: Max 6400

Invalid data is returned as -1000

Measurement Modes DEMTD_SCDMA

Example :FETCh:TD_SCDMA:TAMPlitude:SFSummary?
 might return #525600xxx... (25600-bytes of floating point data) as time
 domain amplitude data of the subframe summary measurement of the
 TD-SCDMA standard.

Related Commands :INSTrument[:SElect]

:FETCh:TD_SCDMA:TAMPlitude:TOOMask? (Query Only)

Fetches the results of the time domain amplitude data of the transmit on/off mask measurement under the TD-SCDMA standard.

NOTE. *There is no :READ subsystem for the TAMPlitude commands.*

Syntax :FETCh:TD_SCDMA:TAMPlitude:TOOMask?

Arguments None

Returns #<Num_digit><Num_byte><Data1(1)><Data1(2)>...<Data(n)>

Where

<Num_digit> is the number of digits in <Num_byte>.

<Num_byte> is the number of bytes of data that follows.

<Data(n)> is the absolute power for each symbol in dBm. 4-Four-byte little endian floating-point format specified in IEEE 488.2.

Measurement level:

n: Max 6400

Invalid data is returned as -1000

Measurement Modes DEMTD_SCDMA

Example :FETCh:TD_SCDMA:TAMPlitude:TOOMask?

might return #525600xxx... (25600-bytes of floating point data) as time domain amplitude data of the transmit on/off mask measurement of the TD-SCDMA standard.

:FETCh:TD_SCDMA:TAMPlitude:TSSummary? (Query Only)

Fetches the results of the time domain amplitude data of the timeslot summary measurement under the TD-SCDMA standard.

NOTE. *There is no :READ subsystem for the TAMPlitude commands.*

Syntax :FETCh:TD_SCDMA:TAMPlitude:TSSummary?

Arguments None

Returns #<Num_digit><Num_byte><Data1(1)><Data1(2)>...<Data(n)>

Where

<Num_digit> is the number of digits in <Num_byte>.

<Num_byte> is the number of bytes of data that follows.

<Data(n)> is the absolute power for each symbol in dBm.

4-Four-byte little endian floating-point format specified in IEEE 488.2.

n: Max 864

Invalid data is returned as -1000

Measurement Modes DEMTD_SCDMA

Example :FETCh:TD_SCDMA:TAMPlitude:TSSummary?
might return #43456xxx... (3456-bytes of floating point data) as time domain amplitude data of the timeslot summary measurement of the TD-SCDMA standard.

Related Commands :INSTrument[:SElect]

:FETCh:M2WLAN Subgroup

WLAN Analysis, Option 29 Only

The :FETCh:M2WLAN commands return the results of the IEEE802.11n MIMO (2x2) analysis.

Command Tree

Header

:FETCh
:M2WLAN?

Parameter

A1TFunction | A2TFunction
| P1TFunction | P2TFunction
| D1PProfile | D2PProfile
| EVTime | PVTime | CONSte | EVSC | PVSC
| SCConste | FERRor | STABle | STYPe

:FETCh:M2WLAN? (Query Only)

Returns the results of the 802.11n MIMO (2x2) analysis.

Syntax :FETCh:M2WLAN? { A1TFunction | A2TFunction
| P1TFunction| P2TFunction| D1PRofile| D2PRofile
| EVTime | PVTime | CONStE | EVSC | PVSC | SCConste
| FERRor | STABle | STYPe }

Arguments Information queried is listed below for each of the arguments:

Table 2-77: Queried information, MIMO (2x2)

Argument	Information queried
A1TFunction	Amplirude transfer function (Trace 1)
A2TFunction	Amplirude transfer function (Trace 2)
P1TFunction	Phase transfer function (Trace 1)
P2TFunction	Phase transfer function (Trace 2)
D1PRofile	Delay profile (Trace 1)
D2PRofile	Delay profile (Trace 2)
EVTime	EVM versus Time
PVTime	Power versus Time
CONStE	Constellation
EVSC	EVM versus Subcarrier
PVSC	Power versus Subcarrier
SCConste	Subcarrier constellation
FERRor	Frequency error
STABle	Symbol table
STYPe	Symbol type

Returns Returns are listed below for each of the arguments. You can select degrees or radians for the angular unit using the :UNIT:ANGLE command.

A1TFunction and A2TFunction.

Returns the amplitude transfer function waveform data:

#<Num_digit><Num_byte><Data(1)><Data(2)>...<Data(n)>

Where

<Num_digit> is the number of digits in <Num_byte>.

<Num_byte> is the number of bytes of data that follow.

<Data(n)> is the amplitude in dBm.

4-byte little endian floating-point format specified in IEEE 488.2.

n: Max 128.

P1TFunction and P2TFunction.

Returns the phase transfer function waveform data:

#<Num_digit><Num_byte><Data(1)><Data(2)>...<Data(n)>

Where

<Num_digit> is the number of digits in <Num_byte>.

<Num_byte> is the number of bytes of data that follow.

<Data(n)> is the phase in degrees or radians.

4-byte little endian floating-point format specified in IEEE 488.2.

n: Max 128.

D1PProfile and D1PProfile.

Returns the delay profile waveform data:

#<Num_digit><Num_byte><Data(1)><Data(2)>...<Data(n)>

Where

<Num_digit> is the number of digits in <Num_byte>.

<Num_byte> is the number of bytes of data that follow.

<Data(n)> is the amplitude in dBm.

4-byte little endian floating-point format specified in IEEE 488.2.

n: Max 512.

EVTime. <EVM_Peak>,<EVM_RMS>,<EVM_Time>,<Merror_Peak>,
<Merror_RMS>,<Merror_Time>,<Perror_Peak>,<Perror_RMS>,
<Perror_Time>

Where

<EVM_Peak>::=<NRf> is the peak EVM in percent (%).

<EVM_RMS>::=<NRf> is the RMS EVM in percent (%).

<EVM_Time>::=<NRf> is the time of the peak and RMS EVM in s.

<Merror_Peak>::=<NRf> is the peak magnitude error in percent (%).

<Merror_RMS>::=<NRf> is the RMS magnitude error in percent (%).

<Merror_Time>::=<NRf> is the time of the peak and RMS magnitude error in s.

<Perror_Peak>::=<NRf> is the peak phase error in degrees or radians.

<Perror_RMS>::=<NRf> is the RMS phase error in degrees or radians.

<Perror_Time>::=<NRf> is the time of the peak and RMS phase error in s.

PVTime. <Power_Peak>,<Power_RMS>,<Power_Time>

Where

<Power_Peak>::=<NRf> is the peak power in dBm.

<Power_RMS>::=<NRf> is the RMS power in dBm.

<Power_Time>::=<NRf> is the time for the peak and RMS power in s.

CONStE. <EVM_Peak>,<EVM_RMS>,<EVM_Time>,<Merror_Peak>,
<Merror_RMS>,<Merror_Time>,<Perror_Peak>,<Perror_RMS>,
<Perror_Time>

Where

<EVM_Peak>::=<NRf> is the peak EVM in percent (%).

<EVM_RMS>::=<NRf> is the RMS EVM in percent (%).

<EVM_Time>::=<NRf> is the time of the peak and RMS EVM in s.

<Merror_Peak>::=<NRf> is the peak magnitude error in percent (%).

<Merror_RMS>::=<NRf> is the RMS magnitude error in percent (%).

<Merror_Time>::=<NRf> is the time of peak and RMS magnitude error in s.

<Perror_Peak>::=<NRf> is the peak phase error in degrees or radians.

<Perror_RMS>::=<NRf> is the RMS phase error in degrees or radians.

<Perror_Time>::=<NRf> is the time of peak and RMS phase error in s.

EVSC. <EVM_Peak>,<EVM_RMS>,<SC_Number>,<Merror_Peak>,
<Merror_RMS>,<SC_Number>,<Perror_Peak>,<Perror_RMS>,<SC_Number>
for OFDM data (SC: subcarrier).

Where

<EVM_Peak>::=<NRf> is the peak EVM in percent (%).

<EVM_RMS>::=<NRf> is the RMS EVM in percent (%).

<SC_Number>::=<NR1> is the SC number of the peak and RMS EVM.

<Merror_Peak>::=<NRf> is the peak magnitude error in percent (%).

<Merror_RMS>::=<NRf> is the RMS magnitude error in percent (%).

<SC_Number>::=<NR1> is the SC number of the peak and RMS magnitude error.

<Perror_Peak>::=<NRf> is the peak phase error in degrees or radians.

<Perror_RMS>::=<NRf> is the RMS phase error in degrees or radians.

<SC_Number>::=<NR1> is the SC number of the peak and RMS phase error.

<EVM_Peak>,<EVM_RMS>,<EVM_Time>,<Merror_Peak>,<Merror_RMS>,
<Merror_Time>,<Perror_Peak>,<Perror_RMS>,<Perror_Time>
for DSSS data:

Where

<EVM_Peak>::=<NRf> is the peak EVM in percent (%).

<EVM_RMS>::=<NRf> is the RMS EVM in percent (%).

<EVM_Time>::=<NRf> is the time of peak and RMS EVM in s.

<Merror_Peak>::=<NRf> is the peak magnitude error in percent (%).

<Merror_RMS>::=<NRf> is the RMS magnitude error in percent (%).

<Merror_Time>::=<NRf> is the time of the peak and RMS magnitude error in s.

<Perror_Peak>::=<NRf> is the peak phase error in degrees or radians.
<Perror_RMS>::=<NRf> is the RMS phase error in degrees or radians.
<Perror_Time>::=<NRf> is the time of peak and RMS phase error in s.

PVSC. <Power_Peak>, <Power_RMS>, <SC_Number> for OFDM data
(SC: subcarrier).

Where

<Power_Peak>::=<NRf> is the peak power in dBm.
<Power_RMS>::=<NRf> is the RMS power in dBm.
<SC_Number>::=<NR1> is the SC number.

<Power_Peak>, <Power_RMS>, <Power_Time> for DSSS data:

Where

<Power_Peak>::=<NRf> is the peak power in dBm.
<Power_RMS>::=<NRf> is the RMS power in dBm.
<Power_Time>::=<NRf> is the time of peak and RMS power in s.

SCConste. <EVM_Peak>, <EVM_RMS>, <SC_Number>, <Merror_Peak>, <Merror_RMS>, <SC_Number>, <Perror_Peak>, <Perror_RMS>, <SC_Number>
(SC: subcarrier)

Where

<EVM_Peak>::=<NRf> is the peak EVM in percent (%).
<EVM_RMS>::=<NRf> is the RMS EVM in percent (%).
<SC_Number>::=<NR1> is the SC number of the peak and RMS EVM.
<Merror_Peak>::=<NRf> is the peak magnitude error in percent (%).
<Merror_RMS>::=<NRf> is the RMS magnitude error in percent (%).
<SC_Number>::=<NR1> is the SC number of the peak and RMS magnitude error.
<Perror_Peak>::=<NRf> is the peak phase error in degrees or radians.
<Perror_RMS>::=<NRf> is the RMS phase error in degrees or radians.
<SC_Number>::=<NR1> is the SC number of the peak and RMS phase error.

FERRor. <Error_Peak>, <Error_RMS>, <Error_Time>

Where

<Error_Peak>::=<NRf> is the peak frequency error in Hz.
<Error_RMS>::=<NRf> is the RMS frequency error in Hz.
<Error_Time>::=<NRf> is the time of the peak and RMS in s.

STABLE. #<Num_digit><Num_byte><Sym(1)><Sym(2)>...<Sym(n)>

Where

<Num_digit> is the number of digits in <Num_byte>.
<Num_byte> is the number of bytes of data that follow.
<Sym(n)>::=<NR1> is the symbol data.
4-byte little endian floating-point format specified in IEEE 488.2.
n: Refer to Table D-9 in *Appendix D* for the maximum value.

STYPe. <Mode>, <Format>, <Symbol>, <GI>, <MCS>

Where

<Mode>::=<NR1> is the operating mode. The value and its meaning are shown in the table below.

Mode	Meaning	Mode	Meaning
-1	Unknown	4	HT 20 MHz
0	Legacy 20 MHz	5	HT 40 MHz
1	Legacy Duplicate	6	HT Duplicate
2	Legacy Upper	7	HT Upper
3	Legacy Lower	8	HT Lower

<Format>::=<NR1> is the signal format.

-1: Unknown; 0: Legacy mode; 1: Mixed mode; 2: Green field.

<Symbol>::=<NR1> is the symbol type. The value and its meaning are shown in the table below.

Symbol	Meaning	Symbol	Meaning
-1	Unknown	11	PBCC 5.5M
0	Long Preamble	12	PBCC 11M
1	Short Preamble	13	PBCC 22M
2	L-STF	14	PBCC 33M
3	L-LTF	15	OFDM BPSK
4	Long Header	16	OFDM QPSK
5	Short Header	17	OFDM 16QAM
6	L-SIG	18	OFDM 64QAM
7	DSSS 1M	19	HT-STF
8	DSSS 2M	20	HT-LTF
9	CCK 5.5M	21	HT-SIG
10	CCK 11M		

<GI>::=<NR1> is the guard interval.

-1: Unknown; 0: Normal (800 ns); 1: Short (400 ns).

<MCS>::=<NR1> is the MCS (Modulation and Coding Scheme) index specified in the 802.11n standard, ranging from 0 to 76. -1: Unknown.

Measurement Modes DEMM2WLAN

Examples :FETCh:M2WLAN? PVTime
might return -2.21,-6.3,-28.7 as the power versus time measurement result.

Related Commands :INSTrument[:SElect], :UNIT:ANGLE

:FETCh:SWLAN Subgroup**WLAN Analysis, Option 29 Only**

The :FETCh:SWLAN commands return the results of the 802.11n (nx1) analysis.

Command Tree	Header	Parameter
	:FETCh	
	:SWLAN?	A1TFunction A2TFunction P1TFunction P2TFunction D1PProfile D2PProfile EVTime PVTime CONSte EVSC PVSC SCConste FERRor OFLatness OLINearity STABle STYPE
	:SMASK?	
	:SPECTrum	
	:SMASK?	

:FETCh:SWLAN? (Query Only)

Returns the results of the 802.11n (nx1) modulation analysis.

Syntax :FETCh:SWLAN? { A1TFunction | A2TFunction
 | P1TFunction | P2TFunction | D1PProfile | D2PProfile
 | EVTime | PVTime | CONSte | EVSC | PVSC | SCConste | FERRor
 | OFLatness | OLINearity | STABLE | STYPE }

Arguments Information queried is listed below for each of the arguments:

Table 2-78: Queried information, 802.11n (nx1)

Argument	Information queried
A1TFunction	Amplitude transfer function (Trace 1)
A2TFunction	Amplitude transfer function (Trace 2)
P1TFunction	Phase transfer function (Trace 1)
P2TFunction	Phase transfer function (Trace 2)
D1PProfile	Delay profile (Trace 1)
D2PProfile	Delay profile (Trace 2)
EVTime	EVM versus Time
PVTime	Power versus Time
CONSte	Constellation
EVSC	EVM versus Subcarrier
PVSC	Power versus Subcarrier
SCConste	Subcarrier constellation
FERRor	Frequency error
OFLatness	OFDM flatness
OLINearity	OFDM linearity
STABLE	Symbol table
STYPE	Symbol type

Returns Returns are listed below for each of the arguments. You can select degrees or radians for the angular unit using the :UNIT:ANGLE command.

A1TFunction and A2TFunction.

Returns the amplitude transfer function waveform data:

#<Num_digit><Num_byte><Data(1)><Data(2)>...<Data(n)>

Where

<Num_digit> is the number of digits in <Num_byte>.

<Num_byte> is the number of bytes of data that follow.

<Data(n)> is the amplitude in dBm.

4-byte little endian floating-point format specified in IEEE 488.2.

n: Max 128.

P1TFunction and P2TFunction.

Returns the phase transfer function waveform data:

#<Num_digit><Num_byte><Data(1)><Data(2)>...<Data(n)>

Where

<Num_digit> is the number of digits in <Num_byte>.

<Num_byte> is the number of bytes of data that follow.

<Data(n)> is the phase in degrees or radians.

4-byte little endian floating-point format specified in IEEE 488.2.

n: Max 128.

D1PProfile and D2PProfile. Returns the delay profile waveform data:

#<Num_digit><Num_byte><Data(1)><Data(2)>...<Data(n)>

Where

<Num_digit> is the number of digits in <Num_byte>.

<Num_byte> is the number of bytes of data that follow.

<Data(n)> is the amplitude value in dBm.

4-byte little endian floating-point format specified in IEEE 488.2.

n: Max 512.

EVTime. <EVM_Peak>, <EVM_RMS>, <EVM_Time>, <Merror_Peak>, <Merror_RMS>, <Merror_Time>, <Perror_Peak>, <Perror_RMS>, <Perror_Time>

Where

<EVM_Peak>::=<NRf> is the peak EVM in percent (%).

<EVM_RMS>::=<NRf> is the RMS EVM in percent (%).

<EVM_Time>::=<NRf> is the time of the peak and RMS EVM in s.

<Merror_Peak>::=<NRf> is the peak magnitude error in percent (%).

<Merror_RMS>::=<NRf> is the RMS magnitude error in percent (%).

<Merror_Time>::=<NRf> is the time of the peak and RMS magnitude error in s.

<Perror_Peak>::=<NRf> is the peak phase error in degrees or radians.

<Perror_RMS>::=<NRf> is the RMS phase error in degrees or radians.

<Perror_Time>::=<NRf> is the time of the peak and RMS phase error in s.

PVTime. <Power_Peak>,<Power_RMS>,<Power_Time>

Where

<Power_Peak>::=<NRf> is the peak power in dBm.

<Power_RMS>::=<NRf> is the RMS power in dBm.

<Power_Time>::=<NRf> is the time for the peak and RMS power in s.

CONSt. <EVM_Peak>,<EVM_RMS>,<EVM_Time>,<Merror_Peak>,
<Merror_RMS>,<Merror_Time>,<Perror_Peak>,<Perror_RMS>,
<Perror_Time>

Where

<EVM_Peak>::=<NRf> is the peak EVM in percent (%).

<EVM_RMS>::=<NRf> is the RMS EVM in percent (%).

<EVM_Time>::=<NRf> is the time of the peak and RMS EVM in s.

<Merror_Peak>::=<NRf> is the peak magnitude error in percent (%).

<Merror_RMS>::=<NRf> is the RMS magnitude error in percent (%).

<Merror_Time>::=<NRf> is the time of peak and RMS magnitude error in s.

<Perror_Peak>::=<NRf> is the peak phase error in degrees or radians.

<Perror_RMS>::=<NRf> is the RMS phase error in degrees or radians.

<Perror_Time>::=<NRf> is the time of peak and RMS phase error in s.

EVSC. <EVM_Peak>,<EVM_RMS>,<SC_Number>,<Merror_Peak>,
<Merror_RMS>,<SC_Number>,<Perror_Peak>,<Perror_RMS>,<SC_Number>
for OFDM data (SC: subcarrier).

Where

<EVM_Peak>::=<NRf> is the peak EVM in percent (%).

<EVM_RMS>::=<NRf> is the RMS EVM in percent (%).

<SC_Number>::=<NR1> is the SC number of the peak and RMS EVM.

<Merror_Peak>::=<NRf> is the peak magnitude error in percent (%).

<Merror_RMS>::=<NRf> is the RMS magnitude error in percent (%).

<SC_Number>::=<NR1> is the SC number of the peak and RMS magnitude error.

<Perror_Peak>::=<NRf> is the peak phase error in degrees or radians.

<Perror_RMS>::=<NRf> is the RMS phase error in degrees or radians.

<SC_Number>::=<NR1> is the SC number of the peak and RMS phase error.

<EVM_Peak>,<EVM_RMS>,<EVM_Time>,<Merror_Peak>,<Merror_RMS>,
<Merror_Time>,<Perror_Peak>,<Perror_RMS>,<Perror_Time>
for DSSS data:

Where

<EVM_Peak>::=<NRf> is the peak EVM in percent (%).

<EVM_RMS>::=<NRf> is the RMS EVM in percent (%).

<EVM_Time>::=<NRf> is the time of peak and RMS EVM in s.

<Merror_Peak>::=<NRf> is the peak magnitude error in percent (%).

<Merror_RMS>::=<NRf> is the RMS magnitude error in percent (%).

<Merror_Time>::=<NRf> is the time of the peak and RMS magnitude error in s.

<Perror_Peak>::=<NRf> is the peak phase error in degrees or radians.
 <Perror_RMS>::=<NRf> is the RMS phase error in degrees or radians.
 <Perror_Time>::=<NRf> is the time of peak and RMS phase error in s.

PVSC. <Power_Peak>,<Power_RMS>,<SC_Number> for OFDM data
 (SC: subcarrier).

Where

<Power_Peak>::=<NRf> is the peak power in dBm.
 <Power_RMS>::=<NRf> is the RMS power in dBm.
 <SC_Number>::=<NR1> is the SC number.

<Power_Peak>,<Power_RMS>,<Power_Time> for DSSS data:

Where

<Power_Peak>::=<NRf> is the peak power in dBm.
 <Power_RMS>::=<NRf> is the RMS power in dBm.
 <Power_Time>::=<NRf> is the time of peak and RMS power in s.

SCConste. <EVM_Peak>,<EVM_RMS>,<SC_Number>,<Merror_Peak>,
 <Merror_RMS>,<SC_Number>,<Perror_Peak>,<Perror_RMS>,<SC_Number>
 (SC: subcarrier)

Where

<EVM_Peak>::=<NRf> is the peak EVM in percent (%).
 <EVM_RMS>::=<NRf> is the RMS EVM in percent (%).
 <SC_Number>::=<NR1> is the SC number of the peak and RMS EVM.
 <Merror_Peak>::=<NRf> is the peak magnitude error in percent (%).
 <Merror_RMS>::=<NRf> is the RMS magnitude error in percent (%).
 <SC_Number>::=<NR1> is the SC number of the peak and RMS magnitude error.
 <Perror_Peak>::=<NRf> is the peak phase error in degrees or radians.
 <Perror_RMS>::=<NRf> is the RMS phase error in degrees or radians.
 <SC_Number>::=<NR1> is the SC number of the peak and RMS phase error.

FERRor. <Ferror_Peak>,<Ferror_RMS>,<Ferror_Time>

Where

<Ferror_Peak>::=<NRf> is the peak frequency error in Hz.
 <Ferror_RMS>::=<NRf> is the RMS frequency error in Hz.
 <Ferror_Time>::=<NRf> is the time of the peak and RMS in s.

OFLatness. <CF_Leakage>::=<NRf> is the center frequency leakage power
 in dB.

OLINearity. #<Num_digit><Num_byte><Data(1)><Data(2)>...<Data(n)>

Where

<Num_digit> is the number of digits in <Num_byte>.

<Num_byte> is the number of bytes of data that follow.

<Data(n)> is the ideal value in watts.

4-byte little endian floating-point format specified in IEEE 488.2.

n: Max 512000 (= 1024 points × 500 frames)

STABLE. #<Num_digit><Num_byte><Sym(1)><Sym(2)>...<Sym(n)>

Where

<Num_digit> is the number of digits in <Num_byte>.

<Num_byte> is the number of bytes of data that follow.

<Sym(n)>::=<NR1> is the symbol data.

4-byte little endian floating-point format specified in IEEE 488.2.

n: Refer to Table D-9 in *Appendix D* for the maximum value.

STYPe. Same as in the :FETCh:M2WLAN? query. Refer to page 2-831.

Measurement Modes

DEMSWLAN

Examples

:FETCh:SWLAN? PVTime

might return -2.21,-6.3,-28.7 as the power versus time measurement result.

Related Commands

:FETCh:M2WLAN?, :INSTrument[:SElect], :UNIT:ANGLE

:FETCh:SWLAN:SMASk? (Query Only)

Returns the result of the spectrum mask measurement in the 802.11n (nx1) analysis.

Syntax :FETCh:SWLAN:SMASk?

Arguments None

Returns <pass_fail>::={ 1 | 0 } is the measurement result; 1: Pass or 0: Fail.
<pass_fail> returns 1 (one) when the test is disabled.

Measurement Modes DEMSWLAN

Examples :FETCh:SWLAN:SMASk?
might return 1, indicating that the test has passed.

Related Commands :INSTrument[:SElect]

:FETCh:SWLAN:SPECTrum:SMASk? (Query Only)

Returns spectrum waveform data of the spectrum mask measurement in the 802.11n (nx1) analysis.

Syntax :FETCh:SWLAN:SPECTrum:SMASk?

Arguments None

Returns #<Num_digit><Num_byte><Data(1)><Data(2)>...<Data(n)>

Where

<Num_digit> is the number of digits in <Num_byte>.

<Num_byte> is the number of bytes of data that follow.

<Data(n)> is the amplitude in dBm.

4-byte little endian floating-point format specified in IEEE 488.2.

n: Max 240001

Measurement Modes DEMSWLAN

Examples :FETCh:SWLAN:SPECTrum:SMASk?
might return #43200xxxx... (3200-byte data) for the spectrum waveform data.

Related Commands :INSTRument[:SElect]

:FETCh:WLAN Subgroup**WLAN Analysis, Option 29 Only**

The :FETCh:WLAN commands return the results of the WLAN analysis.

Command Tree	Header	Parameter
	:FETCh	
	:WLAN?	PVTime EVTime PVSC EVSC CONSte SCConste FERRor OFLatness OLINearity STABle
	:POWer	
	:TPOWer?	POSitive NEGative
	:SMASk?	
	:SPECTrum	
	:SMASk?	
	:TPOWer?	

:FETCh:WLAN? (Query Only)

Returns the results of the WLAN modulation analysis.

Syntax :FETCh:WLAN? { PVTime | EVTime | PVSC | EVSC | CONSte | SCConste
| FERRor | OFLatness | OLINearity | STABLe }

Arguments Information queried is listed below for each of the arguments:

Table 2-79: Queried information

Argument	Information queried
PVTime	Power versus Time
EVTime	EVM versus Time
PVSC	Power versus Subcarrier
EVSC	EVM versus Subcarrier
CONSte	Constellation
SCConste	Subcarrier constellation
FERRor	Frequency error
OFLatness	OFDM flatness
OLINearity	OFDM linearity
STABLe	Symbol table

Returns Returns are listed below for each of the arguments. You can select degrees or radians for the angular unit using the :UNIT:ANGLE command.

PVTime. <Power_Peak>,<Power_RMS>,<Power_Time>

Where

<Power_Peak>::=<NRf> is the peak power in dBm.

<Power_RMS>::=<NRf> is the RMS power in dBm.

<Power_Time>::=<NRf> is the time for the peak and RMS power in s.

EVTime. <EVM_Peak>, <EVM_RMS>, <EVM_Time>, <Merror_Peak>, <Merror_RMS>, <Merror_Time>, <Perror_Peak>, <Perror_RMS>, <Perror_Time>

Where

<EVM_Peak>::=<NRf> is the peak EVM in percent (%).

<EVM_RMS>::=<NRf> is the RMS EVM in percent (%).

<EVM_Time>::=<NRf> is the time of the peak and RMS EVM in s.

<Merror_Peak>::=<NRf> is the peak magnitude error in percent (%).

<Merror_RMS>::=<NRf> is the RMS magnitude error in percent (%).

<Merror_Time>::=<NRf> is the time of the peak and RMS magnitude error in s.

<Perror_Peak>::=<NRf> is the peak phase error in degrees or radians.

<Perror_RMS>::=<NRf> is the RMS phase error in degrees or radians.

<Perror_Time>::=<NRf> is the time of the peak and RMS phase error in s.

PVSC. <Power_Peak>, <Power_RMS>, <SC_Number> for OFDM data (SC: subcarrier).

Where

<Power_Peak>::=<NRf> is the peak power in dBm.

<Power_RMS>::=<NRf> is the RMS power in dBm.

<SC_Number>::=<NR1> is the SC number.

<Power_Peak>, <Power_RMS>, <Power_Time> for DSSS data:

Where

<Power_Peak>::=<NRf> is the peak power in dBm.

<Power_RMS>::=<NRf> is the RMS power in dBm.

<Power_Time>::=<NRf> is the time of peak and RMS power in s.

EVSC. <EVM_Peak>, <EVM_RMS>, <SC_Number>, <Merror_Peak>, <Merror_RMS>, <SC_Number>, <Perror_Peak>, <Perror_RMS>, <SC_Number> for OFDM data (SC: subcarrier).

Where

<EVM_Peak>::=<NRf> is the peak EVM in percent (%).

<EVM_RMS>::=<NRf> is the RMS EVM in percent (%).

<SC_Number>::=<NR1> is the SC number of the peak and RMS EVM.

<Merror_Peak>::=<NRf> is the peak magnitude error in percent (%).

<Merror_RMS>::=<NRf> is the RMS magnitude error in percent (%).

<SC_Number>::=<NR1> is the SC number of the peak and RMS magnitude error.

<Perror_Peak>::=<NRf> is the peak phase error in degrees or radians.

<Perror_RMS>::=<NRf> is the RMS phase error in degrees or radians.

<SC_Number>::=<NR1> is the SC number of the peak and RMS phase error.

<EVM_Peak>,<EVM_RMS>,<EVM_Time>,<Merror_Peak>,<Merror_RMS>,
<Merror_Time>,<Perror_Peak>,<Perror_RMS>,<Perror_Time>
for DSSS data:

Where

<EVM_Peak>::=<NRf> is the peak EVM in percent (%).
<EVM_RMS>::=<NRf> is the RMS EVM in percent (%).
<EVM_Time>::=<NRf> is the time of peak and RMS EVM in s.
<Merror_Peak>::=<NRf> is the peak magnitude error in percent (%).
<Merror_RMS>::=<NRf> is the RMS magnitude error in percent (%).
<Merror_Time>::=<NRf> is the time of the peak and RMS magnitude error in s.
<Perror_Peak>::=<NRf> is the peak phase error in degrees or radians.
<Perror_RMS>::=<NRf> is the RMS phase error in degrees or radians.
<Perror_Time>::=<NRf> is the time of peak and RMS phase error in s.

CONSte. <EVM_Peak>,<EVM_RMS>,<EVM_Time>,<Merror_Peak>,
<Merror_RMS>,<Merror_Time>,<Perror_Peak>,<Perror_RMS>,
<Perror_Time>

Where

<EVM_Peak>::=<NRf> is the peak EVM in percent (%).
<EVM_RMS>::=<NRf> is the RMS EVM in percent (%).
<EVM_Time>::=<NRf> is the time of the peak and RMS EVM in s.
<Merror_Peak>::=<NRf> is the peak magnitude error in percent (%).
<Merror_RMS>::=<NRf> is the RMS magnitude error in percent (%).
<Merror_Time>::=<NRf> is the time of peak and RMS magnitude error in s.
<Perror_Peak>::=<NRf> is the peak phase error in degrees or radians.
<Perror_RMS>::=<NRf> is the RMS phase error in degrees or radians.
<Perror_Time>::=<NRf> is the time of peak and RMS phase error in s.

SCConste. <EVM_Peak>,<EVM_RMS>,<SC_Number>,<Merror_Peak>,
<Merror_RMS>,<SC_Number>,<Perror_Peak>,<Perror_RMS>,<SC_Number>
(SC: subcarrier)

Where

<EVM_Peak>::=<NRf> is the peak EVM in percent (%).
<EVM_RMS>::=<NRf> is the RMS EVM in percent (%).
<SC_Number>::=<NR1> is the SC number of the peak and RMS EVM.
<Merror_Peak>::=<NRf> is the peak magnitude error in percent (%).
<Merror_RMS>::=<NRf> is the RMS magnitude error in percent (%).
<SC_Number>::=<NR1> is the SC number of the peak and RMS magnitude error.
<Perror_Peak>::=<NRf> is the peak phase error in degrees or radians.
<Perror_RMS>::=<NRf> is the RMS phase error in degrees or radians.
<SC_Number>::=<NR1> is the SC number of the peak and RMS phase error.

FERRor. <Error_Peak>,<Error_RMS>,<Error_Time>

Where

<Error_Peak>::=<NRf> is the peak frequency error in Hz.

<Error_RMS>::=<NRf> is the RMS frequency error in Hz.

<Error_Time>::=<NRf> is the time of the peak and RMS in s.

OFLatness. <CF_Leakage>::=<NRf> is the center frequency leakage power in dB.

OLINearity. #<Num_digit><Num_byte><Data(1)><Data(2)>...<Data(n)>

Where

<Num_digit> is the number of digits in <Num_byte>.

<Num_byte> is the number of bytes of data that follow.

<Data(n)> is the ideal value in watts.

4-byte little endian floating-point format specified in IEEE 488.2.

n: Max 512000 (= 1024 points × 500 frames)

STABLE. #<Num_digit><Num_byte><Sym(1)><Sym(2)>...<Sym(n)>

Where

<Num_digit> is the number of digits in <Num_byte>.

<Num_byte> is the number of bytes of data that follow.

<Sym(n)>::=<NR1> is the symbol data.

4-byte little endian floating-point format specified in IEEE 488.2.

n: Refer to Table D-9 in *Appendix D* for the maximum value.

Measurement Modes

DEM WLAN

Examples

:FETCh:WLAN? PVTTime

might return -2.21, -6.3, -28.7 as the power versus time measurement result.

Related Commands

:INSTrument[:SElect], :UNIT:ANGLE

:FETCh:WLAN:POWer:TPOWer? (Query Only)

Returns spectrum waveform data of the transmit power measurement in the WLAN analysis.

Syntax :FETCh:WLAN:POWer:TPOWer? { POSitive | NEGative }

Arguments POSitive specifies the power-on ramp.
NEGative specifies the power-down ramp.

Returns #<Num_digit><Num_byte><Data(1)><Data(2)>...<Data(n)>

Where

<Num_digit> is the number of digits in <Num_byte>.

<Num_byte> is the number of bytes of data that follow.

<Data(n)> is the power spectrum in watts.

4-byte little endian floating-point format specified in IEEE 488.2.

n: Max 512000 (= 1024 points × 500 frames)

Measurement Modes DEMWLAN

Examples :FETCh:WLAN:POWer:TPOWer? POSitive
might return #43200xxxx... (3200-byte data) for the spectrum waveform data of the power-on ramp.

Related Commands :INSTRument[:SELect]

:FETCh:WLAN:SMASK? (Query Only)

Returns the result of the spectrum mask measurement in the WLAN analysis.

Syntax :FETCh:WLAN:SMASK?

Arguments None

Returns <pass_fail>::={ 1 | 0 } is the measurement result; 1: Pass or 0: Fail.
<pass_fail> returns 1 (one) when the test is disabled.

Measurement Modes DEMWLAN

Examples :FETCh:WLAN:SMASK?
might return 1, indicating that the test has passed.

Related Commands :INSTrument[:SElect]

:FETCh:WLAN:SPECTrum:SMASk? (Query Only)

Returns spectrum waveform data of the spectrum mask measurement.

Syntax :FETCh:WLAN:SPECTrum:SMASk?

Arguments None

Returns #<Num_digit><Num_byte><Data(1)><Data(2)>...<Data(n)>

Where

<Num_digit> is the number of digits in <Num_byte>.

<Num_byte> is the number of bytes of data that follow.

<Data(n)> is the amplitude spectrum in dBm.

4-byte little endian floating-point format specified in IEEE 488.2.

n: Max 240001

Measurement Modes DEMWLAN

Examples :FETCh:WLAN:SPECTrum:SMASk?
might return #43200xxxx... (3200-byte data) for the spectrum waveform data.

Related Commands :INSTRument[:SElect]

:FETCh:WLAN:TPOWer? (Query Only)

Returns the results of the transmit power measurement in the WLAN analysis.

Syntax :FETCh:WLAN:TPOWer?

Arguments None

Returns <Power_On>,<Power_Off>

Where

<Power_On>::=<NRf> is the power-on time in s.

<Power_Off>::=<NRf> is the power-down time in s.

Measurement Modes DEMWLAN

Examples :FETCh:WLAN:TPOWer?
might return 1.352039E-6,1.695838E-6 for the transmit power measurement result.

Related Commands :INSTrument[:SElect]

:FETCh:DLR6_3GPP Subgroup

DLR6_3GPP Analysis, Option 40 Only

The :FETCh:ULR6_3GPP commands return the measurement results of the 3GPP-R6 downlink modulation analysis.

For the :FETCh:DLR6_3GPP command subgroups, if you want to perform a FETCh operation on fresh data, use the [:SENSe]:DLR6_3GPP[:IMMediate] command.

Command Tree

Header

```
:FETCh
  :DLR6_3GPP?
```

Parameter

```
CCODE | CSYMBOL | CTSLOT | SCONSTE | EVM
| AEVM | PEVM | MERROR | AMERROR | PMERROR
| PERROR | APEROR | PPEROR | RHO | FERROR
| OOFFSET | STABLE | TSNUMBER | SSCHANNEL
| SCGROU | SCNUMBER | TLENGTH | PCDE | CEVM
| CMERROR | CPEROR | CHRO | COOF | AGSCOPE
| AGVALUE | RGRANT | ANACK
```

:FETCh:DLR6_3GPP? (Query Only)

Returns measurement results of the 3GPP-R6 downlink modulation analysis.

Syntax :FETCh:DLR6_3GPP? { CCODe | CSYMBOL | CTSLOT | SCOnStE | EVM | AEVM | PEVM | MERRor | AMERRor | PMERRor | PERRor | APERRor | PPERror | RHO | FERRor | OOFFset | STABle | TSNumber | SSCHannel | SCGRoup | SCNumber | TLENgth | PCDE | CEVM | CMERRor | CPERror | CHRO | COOF | AGSCOpe | AGValue | RGRant | ANACK }

Arguments Information queried is listed below for each of the arguments:

Table 2- 80: Queried information on the 3GPP-R6 downlink analysis results

Argument	Information queried
CCODe	Power of each channelization code for the specified TS
CSYMBOL	Each symbol power of the specified TS/SC
CTSLOT	Power of each time slot for the specified SC
SCOnStE	Symbol position data for the specified TS/SC
EVM	Measurement results of Error Vector Magnitude for the specified TS/SC
AEVM	RMS value of EVM for the specified TS/SC
PEVM	Peak value of EVM for the specified TS/SC and its symbol number
MERRor	Amplitude error for the specified TS/SC
AMERRor	RMS value of amplitude error for the specified TS/SC
PMERRor	Peak amplitude error for the specified TS/SC and its symbol number
PERRor	Phase error for the specified TS/SC
APERRor	RMS value of phase error for the specified TS/SC
PPERror	Peak phase error for the specified TS/SC and its symbol number
RHO	Value of waveform quality (r) for the specified TS/SC
FERRor	Frequency error for the specified TS
OOFFset	Value of origin offset for the specified TS/SC
STABle	Data from symbol table for the specified TS/SC
TSNumber	Slot number in radio frame for the specified TS
SSCHannel	Secondary Synchronization Channel (SSCH) number for the specified TS
SCGRoup	Scrambling code group for the specified TS
SCNumber	Scrambling code number for the specified TS
TLENgth	Number of analyzed TSs

Table 2-80: Queried information on the 3GPP-R6 downlink analysis results (Cont.)

Argument	Information queried
PCDE	PCDE (Peak Code Domain Error) for the specified TS, and the SC number
CEVM	RMS and peak values of chip EVM for the specified TS
CMERror	RMS and peak values of chip amplitude error for the specified TS
CPERror	RMS and peak values of chip phase error for the specified TS
CRHO	Chip waveform quality (r) for the specified TS
COOF	Chip origin offset for the specified TS
AGSCope	Absolute Grant Scope
AGValue	Absolute Grant Value
RGRant	Relative Grant
ANACK	ACK/NACK

* **TS:** Time slot, **SC:** Short code

To specify the time slot, use the :DISPlay:DLR6_3GPP:AVIew:TSLot command. To specify the channelization code, use the :DISPlay:DLR6_3GPP:AVIew:CCODE command.

Returns Returns are listed below for each of the arguments. You can select degrees or radians for the angular unit using the :UNIT:ANGLE command.

CCODE. #<Num_digit><Num_byte><Cpwr(1)><Cpwr(2)>...<Cpwr(n)>

Where

<Num_digit> is the number of digits in <Num_byte>.

<Num_byte> is the number of bytes of data that follow.

<Cpwr(n)> is the relative or absolute power value for each short code in dB or dBm. 4-byte little endian floating-point format specified in IEEE 488.2.

n: Max 512

CSYMBOL. #<Num_digit><Num_byte><Cpwr(1)><Cpwr(2)>...<Cpwr(n)>

Where

<Num_digit> is the number of digits in <Num_byte>.

<Num_byte> is the number of bytes of data that follow.

<Cpwr(n)> is the relative or absolute power value for each symbol in dB or dBm. 4-byte little endian floating-point format specified in IEEE 488.2.

n: Max 640

CTSLot. #<Num_digit><Num_byte><Cpwr(1)><Cpwr(2)>...<Cpwr(n)>

Where

<Num_digit> is the number of digits in <Num_byte>.

<Num_byte> is the number of bytes of data that follow.

<Cpwr(n)> is the relative or absolute power value for each time slot in dB or dBm. 4-byte little endian floating-point format specified in IEEE 488.2.

n: Max 16000

SCONste. #<Num_digit><Num_byte><Ip(1)><Qp(1)>...<Ip(n)><Qp(n)>

Where

<Num_digit> is the number of digits in <Num_byte>.

<Num_byte> is the number of bytes of data that follow.

<Ip(n)> is the symbol position on the I axis in volts.

<Qp(n)> is the symbol position on the Q axis in volts.

Both <Ip(1)> and <Qp(1)> are in the 4-byte little endian floating-point format specified in IEEE 488.2. n: Max 640.

EVM. #<Num_digit><Num_byte><Evm(1)><Evm(2)>...<Evm(n)>

Where

<Num_digit> is the number of digits in <Num_byte>.

<Num_byte> is the number of bytes of data that follow.

<Evm(n)> is the value of EVM of symbol in percent (%).

4-byte little endian floating-point format specified in IEEE 488.2

n: Max 640

AEVM. <aevm>::=<NRf> is the EVM RMS value in percent (%).

PEVM. <pevm>, <symb>

Where

<pevm>::=<NRf> is the EVM peak value in percent (%).

<symb>::=<NR1> is the symbol number for the EVM peak value.

MERRror. #<Num_digit><Num_byte><Merr(1)><Merr(2)>...<Merr(n)>

Where

<Num_digit> is the number of digits in <Num_byte>.

<Num_byte> is the number of bytes of data that follow.

<Merr(n)> is the value of amplitude error of symbol in percent (%).

4-byte little endian floating-point format specified in IEEE 488.2

n: Max 640

AMERRror. <amer>::=<NRf> is the amplitude error RMS value in percent (%).

PMERror. <pmer>, <symb>

Where

<pmer>::=<NRf> is the amplitude error peak value in percent (%).

<symb>::=<NR1> is the symbol number for the amplitude error peak value.

PERRror. #<Num_digit><Num_byte><Perr(1)><Perr(2)>...<Perr(n)>

Where

<Num_digit> is the number of digits in <Num_byte>.

<Num_byte> is the number of bytes of data that follow.

<Perr(n)> is the value of phase error of symbol in degrees or radians.

4-byte little endian floating-point format specified in IEEE 488.2

n: Max 640

APERror. <pmer>::=<NRf> is the phase error RMS value in degrees or radians.

PPERror. <pmer>, <symb>

Where

<pmer>::=<NRf> is the phase error peak value in degrees or radians.

<symb>::=<NRf> is the symbol number of phase error peak value.

RHO. <rho>::=<NRf> is the measured value of waveform quality.

FERRror. <ferr>::=<NRf> is the measured value of frequency error in Hz.

OOFFset. <ooff>::=<NRf> is the measured value of origin offset in dB.

STABLE. #<Num_digit><Num_byte><Sym(1)><Sym(2)>...<Sym(n)>

Where

<Num_digit> is the number of digits in <Num_byte>.

<Num_byte> is the number of bytes of data that follow.

<Sym(n)>::=<NR1> is the symbol data.

n: Max 640.

TSNumber. <tsnum>::=<NR1> is the slot number in radio frame.

SSCHannel. <ssch>::=<NR1> is the S-SCH (Secondary Synchronization Channel) number.

SCGRoup. <scgr>::=<NR1> is the scrambling code group.

SCNumber. <scnum>::=<NR1> is the scrambling code number.

TLENgth. <tlen>::=<NR1> is the number of analyzed time slots.

PCDE. <pcde>, <scod>

Where

<pcde>::=<NRf> is the PCDE (Peak Code Domain Error) value in dB.

<scod>::=<NRf> is the short code number for the PCDE

CEVM. <cevma>, <cevmp>

Where

<cevma>::=<NRf> is the RMS value of chip EVM in percent (%).

<cevmp>::=<NRf> is the peak value of chip EVM in percent (%).

CMERror. <cmera>, <cmerp>

Where

<cmera>::=<NRf> is the RMS value of chip amplitude error in percent (%).

<cmerp>::=<NRf> is the peak value of chip amplitude error in percent (%).

CPERror. <cpera>, <cperp>

Where

<cpera>::=<NRf> is the RMS value of chip phase error in degrees or radians.

<cperp>::=<NRf> is the peak value of chip phase error in degrees or radians.

CRHO. <crho>::=<NRf> is the chip waveform quality (ρ).

COOF. <coof>::=<NRf> is the chip origin offset in dB.

AGSCope. <agsc>::=<NR1> is the Absolute Grant Scope (0 or 1).

AGValue. <agv>::=<NR1> is the Absolute Grant value (0 to 31).

RGRant. <rgr>::=<NR1> is the Relative Grant value.

1 (UP), 0 (Hold), or -1 (DOWN).

ANACK. <anac>::=<NR1> is the ACK/NACK value.

1 (ACK), 0 (NACK0), or -1 (NACK1).

NACK0: NACK (RLSs not containing the serving E-DCH cell)

NACK1: NACK (RLS containing the serving E-DCH cell)

Measurement Modes

DEMDLR6_3G

Examples

:FETCh:DLR6_3GPP? CCODe

might return #3256xxxx... (256-byte data) for the power of each channelization code.

Related Commands

:DISPlay:DLR6_3G:AVIew:CCODE, :DISPlay:DLR6_3GP:AVIew:TSLot,
:INSTrument[:SELEct], :UNIT:ANGLE

:FETCh:ULR6_3GPP Subgroup

DLR6_3GPP Analysis, Option 40 Only

The :FETCh:ULR6_3GPP commands return the measurement results of the 3GPP-R6 uplink modulation analysis.

For the :FETCh:ULR6_3GPP command subgroups, if you want to perform a FETCh operation on fresh data, use the [:SENSe]:ULR6_3GPP[:IMMediate] command.

Command Tree	Header	Parameter
	:FETCh	
	:ULR6_3GPP?	ANACK CNUMBER CSYMBOL CTSLOT SCONSTE EVM AEVM PEVM MERROR AMERROR PMERROR PERROR APERROR PPEROR RHO FERROR OOFFSET STABLE TSNUMBER SSCHANNEL SCGROUP SCNUMBER TLENGTH PCDE CEVM CMERROR CPEROR CRHO COOF PDISCONT TFCI TPC ETFCI HAPPY CINFORMATION

:FETCh:ULR6_3GPP? (Query Only)

Returns measurement results of the 3GPP-R6 uplink modulation analysis.

Syntax :FETCh:ULR6_3GPP? { ANACK | CNUMber | CSYMBOL | CTSLOT | SCONSte
| EVM | AEVM | PEVM | MERRor | AMERRor | PMERRor | PERRor
| APERRor | PPERRor | RHO | FERRor | OOFFset | STABLE | TSNumber
| SSCHannel | SCGRoup | SCNumber | TLENgth | PCDE | CEVM | CMERRor
| CPERRor | CHRO | COOF | PDIScont | TFCI | TPC | ETFCi | HAPPY
| CINformation }

Arguments Information queried is listed below for each of the arguments:

Table 2- 81: Queried information on the 3GPP-R6 uplink analysis results

Argument	Information queried
ANACK	ACK/NACK
CNUMber	Power of each channelization code for the specified TS
CSYMBOL	Each symbol power of the specified TS/CN
CTSLot	Power of each time slot for the specified CN
SCONste	Symbol position data for the specified TS/CN
EVM	Measurement results of Error Vector Magnitude for the specified TS/CN
AEVM	RMS value of EVM for the specified TS/CN
PEVM	Peak value of EVM for the specified TS/CN and its symbol number
MERRor	Amplitude error for the specified TS/CN
AMERRor	RMS value of amplitude error for the specified TS/CN
PMERRor	Peak amplitude error for the specified TS/CN and its symbol number
PERRor	Phase error for the specified TS/CN
APERRor	RMS value of phase error for the specified TS/CN
PPERRor	Peak phase error for the specified TS/CN and its symbol number
RHO	Value of waveform quality (r) for the specified TS/CN
FERRor	Frequency error for the specified TS
OOFFset	Value of origin offset for the specified TS/CN
STABLE	Data from symbol table for the specified TS/CN
TSNumber	Slot number in radio frame for the specified TS
SSCHannel	Secondary Synchronization Channel (SSCH) number for the specified TS
SCGRoup	Scrambling code group for the specified TS
SCNumber	Scrambling code number for the specified TS

<anack(i)>::=<NR1> is the indicator.

0: ACK, 1: NACK, or 2: DTX (Discontinuous Transmission).

<cqi(i)>::=<NR1> is the value of CQI detected in the time slot (0 to 29).

<offset(i)>::=<NR1> is the subframe offset (0 to 9).

CNUMBER.

When :DISPlay:ULR6_3GPP:AVIew:FORMat is set to CHANnel.

#<Num_digit><Num_byte><Cpwr(1)><Cpwr(2)>...<Cpwr(13)>

Where

<Num_digit> is the number of digits in <Num_byte>.

<Num_byte> is the number of bytes of data that follow.

<Cpwr(n)> is the relative or absolute power value for each channelization code in dB or dBm. 4-byte little endian floating-point format specified in IEEE 488.2.

When :DISPlay:ULR6_3GPP:AVIew:FORMat is set to IQSPlit

and :DISPlay:ULR6_3GPP:AVIew:IQBranch is set to I or Q.

#<Num_digit><Num_byte><Cpwr(1)><Cpwr(2)>...<Cpwr(n)>

Where

<Num_digit> is the number of digits in <Num_byte>.

<Num_byte> is the number of bytes of data that follow.

<Cpwr(n)> is the relative or absolute power value for each channelization code in dB or dBm. 4-byte little endian floating-point format specified in IEEE 488.2.

n: Max 256.

When :DISPlay:ULR6_3GPP:AVIew:FORMat is set to IQSPlit

and :DISPlay:ULR6_3GPP:AVIew:IQBranch is set to BOTH.

#<Num_digit><Num_byte><ICpwr(1)><QCpwr(1)><ICpwr(2)><QCpwr(2)>
...<ICpwr(n)><QCpwr(n)>

Where

<Num_digit> is the number of digits in <Num_byte>.

<Num_byte> is the number of bytes of data that follow.

<ICpwr(n)><QCpwr(n)> are the relative or absolute power values of I and Q components for each channelization code in dB or dBm.

4-byte little endian floating-point format specified in IEEE 488.2.

n: Max 256.

CSYMBOL. #<Num_digit><Num_byte><Cpwr(1)><Cpwr(2)>...<Cpwr(n)>

Where

<Num_digit> is the number of digits in <Num_byte>.

<Num_byte> is the number of bytes of data that follow.

<Cpwr(n)> is the relative or absolute power value for each symbol in dB or dBm. 4-byte little endian floating-point format specified in IEEE 488.2.

n: Max 1280.

CTSLot. #<Num_digit><Num_byte><Cpwr(1)><Cpwr(2)>...<Cpwr(n)>

Where

<Num_digit> is the number of digits in <Num_byte>.

<Num_byte> is the number of bytes of data that follow.

<Cpwr(n)> is the relative or absolute power value for each time slot in dB or dBm. 4-byte little endian floating-point format specified in IEEE 488.2.

n: Max 16000.

SCONste. #<Num_digit><Num_byte><Ip(1)><Qp(1)>...<Ip(n)><Qp(n)>

Where

<Num_digit> is the number of digits in <Num_byte>.

<Num_byte> is the number of bytes of data that follow.

<Ip(n)> is the symbol position on the I axis in volts.

<Qp(n)> is the symbol position on the Q axis in volts.

Both <Ip(1)> and <Qp(1)> are in the 4-byte little endian floating-point format specified in IEEE 488.2. n: Max 1280.

EVM. #<Num_digit><Num_byte><Evm(1)><Evm(2)>...<Evm(n)>

Where

<Num_digit> is the number of digits in <Num_byte>.

<Num_byte> is the number of bytes of data that follow.

<Evm(n)> is the value of EVM of symbol in percent (%).

4-byte little endian floating-point format specified in IEEE 488.2

n: Max 1280.

AEVM. <aevm>::=<NRf> is the EVM RMS value in percent (%).

PEVM. <pevm>, <symb>

Where

<pevm>::=<NRf> is the EVM peak value in percent (%).

<symb>::=<NR1> is the symbol number for the EVM peak value.

MERRror. #<Num_digit><Num_byte><Merr(1)><Merr(2)>...<Merr(n)>

Where

<Num_digit> is the number of digits in <Num_byte>.

<Num_byte> is the number of bytes of data that follow.

<Merr(n)> is the value of amplitude error of symbol in percent (%).

4-byte little endian floating-point format specified in IEEE 488.2

n: Max 1280.

AMERror. <amer>::=<NRf> is the amplitude error RMS value in percent (%).

PMERror. <pmer>, <symb>

Where

<pmer>::=<NRf> is the amplitude error peak value in percent (%).

<symb>::=<NR1> is the symbol number for the amplitude error peak value.

PERRror. #<Num_digit><Num_byte><Perr(1)><Perr(2)>...<Perr(n)>

Where

<Num_digit> is the number of digits in <Num_byte>.

<Num_byte> is the number of bytes of data that follow.

<Perr(n)> is the value of phase error of symbol in degrees or radians.

4-byte little endian floating-point format specified in IEEE 488.2

n: Max 1280.

APERror. <pmer>::=<NRf> is the phase error RMS value in degrees or radians.

PPERror. <pmer>, <symb>

Where

<pmer>::=<NRf> is the phase error peak value in degrees or radians.

<symb>::=<NRf> is the symbol number of phase error peak value.

RHO. <rho>::=<NRf> is the measured value of waveform quality.

FERRror. <ferr>::=<NRf> is the measured value of frequency error in Hz.

OOFFset. <ooff>::=<NRf> is the measured value of origin offset in dB.

STABLE. #<Num_digit><Num_byte><Sym(1)><Sym(2)>...<Sym(n)>

Where

<Num_digit> is the number of digits in <Num_byte>.

<Num_byte> is the number of bytes of data that follow.

<Sym(n)>::=<NR1> is the symbol data.

n: Max 1280.

TSNumber. <tsnum>::=<NR1> is the slot number in radio frame.

TLENgth. <t len>::=<NR1> is the number of analyzed time slots.

PCDE. <pcde>, <scod>

Where

<pcde>::=<NRf> is the PCDE (Peak Code Domain Error) value in dB.

<scod>::=<NRf> is the channelization code number for the PCDE

CEVM. <cevma>, <cevmp>

Where

<cevma>::=<NRf> is the RMS value of chip EVM in percent (%)

<cevmp>::=<NRf> is the peak value of chip EVM in percent (%)

CMEError. <cmera>,<cmerp>

Where

<cmera>::=<NRf> is the RMS value of chip amplitude error in percent (%).

<cmerp>::=<NRf> is the peak value of chip amplitude error in percent (%).

CPEError. <cpera>,<cperp>

Where

<cpera>::=<NRf> is the RMS value of chip phase error in degrees or radians.

<cperp>::=<NRf> is the peak value of chip phase error in degrees or radians.

CRHO. <crho>::=<NRf> is the chip waveform quality (ρ).

COOF. <coof>::=<NRf> is the chip origin offset in dB.

SIGNature. <sig>::=<NR1> is the signature number in preamble.

PDIScontinuity. <pdis>::=<NRf> is the phase discontinuity in degrees or radians.

TFCI. <tfcI>::=<NR1> is the TFCI value (0 to 1023).

TPC. <tpc>::=<NR1> is the TPC value (0 or 1).

ETFCi. <etfci>::=<NR1> is the E-TFCI value (0 to 127).

RSN. <rsn>::=<NR1> is the RSN value (0 to 3).

HAPPy. <happy>::=<NR1> is the Happy bit value (0 or 1).

CINformation.

When *:DISPLay:ULR6_3GPP:AVIew:FORMat* is set to *CHANnel*
<CInfo>::=<string> is the channel information.

When *:DISPLay:ULR6_3GPP:AVIew:FORMat* is set to *IQSPlit*
<ICInfo>,<QCInfo>

Where

<ICInfo>::=<string> is the channel information on the I branch.

<QCInfo>::=<string> is the channel information on the Q branch.

Measurement Modes DEMULR6_3G

Examples :FETCh:ULR6_3GPP? CNUMber
might return #3256xxxx... (256-byte data) for the power of each channelization code.

Related Commands

:DISPlay:ULR6_3GPP:AVIew:CCODE,
:DISPlay:ULR6_3GPP:AVIew:CNUMBER,
:DISPlay:ULR6_3GPP:AVIew:FORMat, :DISPlay:ULR6_3GPP:AVIew:TSLot,
:INSTrument[:SElect], :UNIT:ANGLE

:FORMat Commands

The FORMat commands define the data output format.

Command Tree

Header	Parameter
:FORMat	
:BORDER	NORMa1 SWAPPed
[:DATA]	REAL,32 REAL,64

:FORMat:BORDER(?)

Sets or queries the byte order for transferring binary data.

Syntax :FORMat:BORDER { NORMa1 | SWAPped }
 :FORMat:BORDER?

Arguments NORMa1 selects the normal byte order.
 SWAPped swaps the byte order.

Measurement Modes All

Examples :FORMat:BORDER SWAPped
 swaps the byte order for data output.

:FORMat[:DATA](?)

Selects or queries the output data format.

Syntax :FORMat[:DATA] { REAL,32 | REAL,64 }
 :FORMat[:DATA]?

Arguments REAL,32 specifies the 32-bit floating point format.
 REAL,64 specifies the 64-bit floating point format.

Measurement Modes All

Examples :FORMat:DATA REAL,32
 specifies the 32-bit floating point format for data output.

:HCOPY Commands

The :HCOPY commands control screen hardcopy.

Command Tree

Header	Parameter
:HCOPY	
:BACKground	BLACK WHITE
:DESTination	PRINter MMEMory
[:IMMediate]	

:HCOPY:BACKground(?)

Selects or queries the hardcopy background color.

Syntax :HCOPY:BACKground { BLACK | WHITE }
:HCOPY:BACKground?

Arguments BLACK outputs the screen image in the black background, without reversing it.
WHITE reverses the screen image to output it in the white background.

Measurement Modes All

Examples :HCOPY:BACKground WHITE
reverses the screen image to output it in the white background.

:HCOPY:DESTination(?)

Selects or queries the hardcopy output destination (printer or file).

Syntax :HCOPY:DESTination { PRINter | MMEory }
:HCOPY:DESTination?

Arguments PRINter specifies that the hardcopy is output to the preset printer, which is the one that has been set as the printer to be used usually under Windows. For using the printer, refer to the *RSA3408A User Manual*.

MMEory specifies that the hardcopy is output to the bitmap file specified with the :MMEory:NAME command.

Measurement Modes All

Examples :HCOPY:DESTination PRINter
specifies that the hardcopy is output to the preset printer.

Related Commands :HCOPY[:IMMediate], :MMEory:NAME

:HCOPY[:IMMEDIATE] (No Query Form)

Outputs the screen hardcopy to the destination selected with the :HCOPY:DESTINATION command.

Syntax :HCOPY[:IMMEDIATE]

Arguments None

Measurement Modes All

Examples :HCOPY:IMMEDIATE
outputs the screen hardcopy.

Related Commands :HCOPY:DESTINATION

:INITiate Commands

The :INITiate commands control data acquisition.

Command Tree

Header	Parameter
:INITiate	
:CONTinuous	<boolean>
[:IMMediate]	
:REStart	

:INITiate:CONTInuous(?)

Determines whether to use the continuous mode to acquire the input signal.

Syntax :INITiate:CONTInuous { OFF | ON | 0 | 1 }
 :INITiate:CONTInuous?

Arguments OFF or 0 specifies that the single mode, rather than the continuous mode, is used for data acquisition. To initiate the acquisition, use the :INITiate[:IMMEDIATE], described below.

To stop the acquisition because the trigger is not generated in single mode, send the following command:

```
:INITiate:CONTInuous OFF
```

ON or 1 initiates data acquisition in the continuous mode.

To stop the acquisition in the continuous mode, send the following command:

```
:INITiate:CONTInuous OFF
```

NOTE. When the analyzer receives a :FETCh command while operating in the continuous mode, it returns an execution error. If you want to run a :FETCh, use the :INITiate[:IMMEDIATE] command.

Measurement Modes All

Examples :INITiate:CONTInuous ON
 specifies that the continuous mode is used to acquire the input signal.

Related Commands :FETCh commands, :INITiate[:IMMEDIATE]

:INITiate[:IMMediate] (No Query Form)

Starts input signal acquisition.

Syntax :INITiate[:IMMediate]

Arguments None

Measurement Modes All

Examples :INITiate:IMMediate
Starts input signal acquisition.

Related Commands :INITiate:CONTinuous

:INITiate:REStart (No Query Form)

Reruns input signal acquisition. In the single mode, this command is equivalent to the :INITiate[:IMMediate] command. In the continuous mode, this command is equivalent to the :ABORt command.

Syntax :INITiate:REStart

Arguments None

Measurement Modes All

Examples :INITiate:REStart
reruns input signal acquisition.

Related Commands :ABORt, :INITiate[:IMMediate]

:INPut Commands

The :INPut commands control the characteristics of the signal input.

Command Tree

Header	Parameter
:INPut	
:ALEVel	
:ATTenuation	<numeric_value>
:AUTO	<boolean>
:MIXer	<numeric_value>
:MLEVel	<numeric_value>

:INPut:ALEVel (No Query Form)

Adjusts amplitude automatically for the best system performance using the input signal as a guide.

Syntax :INPut:ALEVel

Arguments None

Measurement Modes All

Examples :INPut:ALEVel
adjusts amplitude automatically.

:INPut:ATTenuation(?)

When you have selected OFF or 0 in the :INPut:ATTenuation:AUTO command, described below, use this command to set the input attenuation. The query version of this command returns the input attenuation setting.

Syntax :INPut:ATTenuation <rel_amp1>
:INPut:ATTenuation?

Arguments <rel_amp1>::=<NR1> specifies the input attenuation.
Range: 0 to 55 dB in 5 dB steps
 0 to 35 dB in 5 dB steps (Option 03 IQ input)

Measurement Modes All

Examples :INPut:ATTenuation 20
sets the input attenuation to 20 dB.

Related Commands :INPut:ATTenuation:AUTO

:INPut:ATTenuation:AUTO(?)

Determines whether to automatically set the input attenuation according to the reference level.

Syntax :INPut:ATTenuation:AUTO { OFF | ON | 0 | 1 }
:INPut:ATTenuation:AUTO?

Arguments OFF or 0 specifies that the input attenuation is not set automatically. To set it, use the :INPut:ATTenuation command, described above.
ON or 1 specifies that the input attenuation is set automatically.

Measurement Modes All

Examples :INPut:ATTenuation:AUTO ON
specifies that the input attenuation is set automatically.

Related Commands :INPut:ATTenuation

:INPut:MIXer(?)

Selects or queries the mixer level.

NOTE. To set the mixer level, you must have selected On in the :INPut:ATTenuation:AUTO command.

Syntax :INPut:MIXer <amp1>
 :INPut:MIXer?

Arguments <amp1> ::= <NR1> specifies the mixer level.
 Range: -25 to 0 dBm in 5 dBm steps

Measurement Modes All

Examples :INPut:MIXer -20
 sets the mixer level to -20 dBm.

Related Commands :INPut:ATTenuation:AUTO

:INPut:MLEVel(?)

Sets or queries the reference level. Using this command to set the reference level is equivalent to pressing the **AMPLITUDE** key and then the **Ref Level** side key on the front panel.

Syntax :INPut:MLEVel <amp1>
 :INPut:MLEVel?

Arguments <amp1>: :=<NR1> specifies the reference level. The valid settings depend on the measurement frequency band as shown in Table 2-82.

Table 2-82: Reference level range

Frequency band	Setting
Baseband (DC to 40 MHz)	-30 to +20 dBm (in 5 dB steps)
RF (40 MHz to 8 GHz)	-50 to +30 dBm (in 1 dB steps)
IQ (Option 03 only)	-10 to +20 dBm (in 5 dB steps)

Measurement Modes All

Examples :INPut:MLEVel -10
 sets the reference level to -10 dBm.

:INSTrument Commands

The :INSTrument commands set the measurement mode. Before you can start a measurement, you must set the mode appropriate for the measurement using these commands.

Command Tree

Header	Parameter
:INSTrument	
:CATalog?	
[:SElect]	<mode_name>

:INSTRUMENT:CATALOG? (Query Only)

Queries all the measurement modes incorporated in the analyzer.

Syntax :INSTRUMENT:CATALOG?

Arguments None

Returns <string> contains the measurement mode names available in the analyzer returned as comma-separated character strings. The following table lists the mode names and their meanings:

Table 2-83: Measurement mode

Mnemonic	Meaning
S/A mode	
SANORMAL	Normal spectrum analysis
SASGRAM	Spectrum analysis with spectrogram
SARTIME	Real-time spectrum analysis
SAZRTIME	Real-time spectrum analysis with zoom function
SAUL3G	W-CDMA uplink spectrum analysis (Option 23 only)
SADLR5_3G	3GPP-R5 downlink spectrum analysis (Option 27 only)
SAULR5_3G	3GPP-R5 uplink spectrum analysis (Option 27 only)
Demod mode	
DEMADEM	Analog modulation analysis
DEMDDDEM	Digital modulation analysis (Option 21 only)
DEMRFID	RFID analysis (Option 21 only)
DEMUL3G	W-CDMA uplink modulation analysis (Option 23 only)
DEMGSMEDGE	GSM/EDGE modulation analysis (Option 24 only)
DEMFLCDMA2K	cdma2000 forward link analysis (Option 25 only)
DEMRLCDMA2K	cdma2000 reverse link analysis (Option 25 only)
DEMFL1XEVD0	cdma2000 1xEV-DO forward link analysis (Option 26 only)
DEMRL1XEVD0	cdma2000 1xEV-DO reverse link analysis (Option 26 only)
DEMDLR5_3G	3GPP-R5 downlink modulation analysis (Option 27 only)
DEMULR5_3G	3GPP-R5 uplink modulation analysis (Option 27 only)
DEMTD_SCDMA	TD-SCDMA modulation analysis (Option 28 only)

Table 2-83: Measurement mode (Cont.)

Mnemonic	Meaning
DEM WLAN	IEEE802.11a/b/g analysis (Option 29 only)
DEMS WLAN	IEEE802.11n (nx1) analysis (Option 29 only)
DEMM2 WLAN	IEEE802.11n MIMO (2x2) analysis (Option 29 only)
DEMDLR_3G	3GPP-R6 downlink modulation analysis (Option 40 only)
DEMULR_3G	3GPP-R6 uplink modulation analysis (Option 40 only)
Time mode	
TIMCCDF	CCDF analysis
TIMTRAN	Time characteristics analysis
TIMPULSE	Pulse characteristics analysis
TIMSSOURCE	Signal source analysis (Option 21 only)

If all options are installed, all the above mode names are returned as comma-separated character strings.

Measurement Modes All

Examples :INSTrument:CATalog?
might return "SANORMAL", "SASGRAM", "SARTIME", "DEMADEM", "TIMCCDF", "TIMTRAN" for all the measurement modes that the analyzer has.

:INSTRUMENT[:SELECT](?)

Selects or queries the measurement mode.

This command is not affected by *RST.

NOTE. *If you want to change the measurement mode, stop the data acquisition with the :INITiate:CONTinuous OFF command.*

Syntax :INSTRUMENT[:SELECT] { SANORMAL | SASGRAM | SARTIME | SAZRTIME
 | SAUL3G | SADLR5_3G | SAULR5_3G | DEMADEM | DEMDDEM
 | DEMRFID | DEMUL3G | DEMDLR5_3G | DEMULR5_3G | DEMGSMEDGE
 | DEMFLCDMA2K | DEMRLCDMA2K | DEMFL1XEVD0 | DEMRL1XEVD0
 | DEMTD_SCDMA | DEMWLAN | DEMSWLAN | DEMM2WLAN
 | DEMDLR6_3G | DEMULR6_3G
 | TIMCCDF | TIMTRAN | TIMPULSE | TIMSSOURCE }

 :INSTRUMENT[:SELECT]?

Arguments <string>

For details of the modes, refer to Table 2-83 on the previous page.

Examples :INSTRUMENT:SELECT "DEMADEM"
 places the analyzer in the analog modulation analysis mode.

Related Commands :CONFigure, :INITiate:CONTinuous

:MMEMory Commands

The :MMEMory commands allow you to manipulate files on the internal hard disk and external mass storage. For details on file manipulation, refer to the *RSA3408A User Manual*.

NOTE. Use the absolute path to specify the file name. For example, suppose that data file *Sample1.iqt* is located in the *My Documents* folder of Windows. You can specify it as “*C:\My Documents\Sample1.iqt*.”

Command Tree

Header	Parameter
:MMEMory	
:COpy	<file_name1>,<file_name2>
:DELeTe	<file_name>
:LOAD	
:CORRection	<file_name>
:IQT	<file_name>
:LIMit	<file_name> (Option 25, 26, 27, and 28)
:RX<x>	<file_name> (Option 29)
:STATe	<file_name>
:TRACe<x>	<file_name>
:NAME	<file_name>
:STORE	
:ACPower	<file_name> (Option 21)
:CORRection	<file_name>
:IQT	<file_name>
:LIMit	<file_name> (Option 25, 26, 27, and 28)
:PULSe	<file_name>
:RESuLt (Option 29)	
:ALLData	<file_name>
:BOTHtrace	<file_name>
:NPACkets	
[:NUMBer]	<numeric_value>
:ONETrace	<file_name>
:POFFset	
[:NUMBer]	<numeric_value>
:TRACe	<file_name>
:TWOTrace	<file_name>
:RESuLt (Option 40)	
:ITEM	CDPower CPSYmbol SEVM STABle MACCuracy
:MCONtent	EVM MERRor PERRor ALL
[:SELeCt]	<file_name>
:TSLot	
:NUMBer	<numeric_value>
:OFFSet	<numeric_value>
:STABle	<file_name> (Option 21, 23, 25, 26, 27, 28, and 29)
:STATe	<file_name>
:TRACe	<file_name>

:MMEMory:COpy (No Query Form)

Copies the contents of a file to another.

Syntax :MMEMory:COpy <file_name1>,<file_name2>

Arguments <file_name1>::=<string> specifies the source file.

<file_name2>::=<string> specifies the destination file.

Measurement Modes All

Examples :MMEMory:COpy "C:\My Documents\File1","C:\My Documents\File2"
copies the contents of File1, located in the My Documents folder, to File2.

:MMEMory:DElete (No Query Form)

Deletes the specified file.

Syntax :MMEMory:DElete <file_name>

Arguments <file_name>::=<string> specifies the file to be deleted.

Measurement Modes All

Examples :MMEMory:DElete "C:\My Documents\File1"
deletes File1 located in the My Documents folder.

:MMEMory:LOAD:CORRection (No Query Form)

Loads the amplitude correction file.

Syntax :MMEMory:LOAD:CORRection <file_name>

Arguments <file_name>::=<string> specifies the file that contains the amplitude correction table. The file extension is .cor.

Measurement Modes All S/A modes except SARTIME and SAZRTIME

Examples :MMEMory:LOAD:CORRection "C:\My Documents\File1.cor"
loads the correction table from File1.cor in the My Documents folder.

:MMEMory:LOAD:IQT (No Query Form)

Loads IQ data in time domain from the specified file.

NOTE. In the Demod (modulation analysis) and the Time (time analysis) modes, use the [:SENSe]:Standard[:IMMediate] command to analyze the loaded data. For example, execute the [:SENSe]:DDEMod[:IMMediate] command in the digital modulation analysis.

Syntax :MMEMory:LOAD:IQT <file_name>

Arguments <file_name>::=<string> specifies the file from which to load IQ data. The file extension is .iqt.

Measurement Modes SARTIME, SAZRTIME, all Demod modes, all Time modes

Examples :MMEMory:LOAD:IQT "C:\My Documents\Data1.iqt"
loads IQ data from the Data1.iqt file in the My Documents folder.

Related Commands [:SENSe]:Standard[:IMMediate]

:MMEMory:LOAD:LIMit (No Query Form)*Option 25, 26, 27, and 28*

Loads limits from the specified file.

Syntax :MMEMory:LOAD:LIMit <file_name>**Arguments** <file_name>::=<string> specifies the file from which to load limits.
The file extension is .lmt.**Measurement Modes** DEMFLCDMA2K, DEMRLCDMA2K, DEMFL1XEVD0, DEMRL1XEVD0,
DEMTD_SCDMA, SADLR5_3G, SAULR5_3G**Examples** :MMEMory:LOAD:LIMit "C:\My Documents\Test.lmt"
loads limits from the Test.lmt file in the My Documents folder.**:MMEMory:LOAD:RX<x> (No Query Form)***Option 29 Only*

Loads the waveform data received by the antenna 1 or 2 from a specified file in the IEEE802.11n MIMO (2x2) analysis.

Syntax :MMEMory:LOAD:RX<x> <file_name>

Where <x>::=[1] | 2.

RX1 and RX2 represent the receiving antenna 1 and 2 waveform, respectively.

Arguments <file_name>::=<string> specifies the file from which to load waveform data.
The file extension is .iqt.**Measurement Modes** DEMM2WLAN**Examples** :MMEMory:LOAD:RX1 "C:\My Documents\Waveform1.iqt"
loads the waveform data of the receiving antenna 1 from the Waveform1.iqt file in the My Documents folder.

:MMEMory:LOAD:STATe (No Query Form)

Loads settings from the specified file.

Syntax :MMEMory:LOAD:STATe <file_name>

Arguments <file_name>::=<string> specifies the file from which to load settings.
The file extension is .cfg.

Measurement Modes All

Examples :MMEMory:LOAD:STATe "C:\My Documents\Setup1.cfg"
loads settings from the Setup1.cfg file in the My Documents folder.

:MMEMory:LOAD:TRACe<x> (No Query Form)

Loads Trace 1 or 2 waveform data from the specified file.

Syntax :MMEMory:LOAD:TRACe<x> <file_name>

Arguments <file_name>::=<string> specifies the file from which to load trace data.
The file extension is .trc.

Measurement Modes All S/A modes except SARTIME and SAZRTIME

Examples :MMEMory:LOAD:TRACe "C:\My Documents\Trace1.trc"
loads Trace 1 data from the Trace1.trc file in the My Documents folder.

Related Commands :MMEMory:STORe:TRACe<x>

:MMEMory:NAME(?)

Specifies or queries the file name when the hardcopy output destination is a file. To select the hardcopy output destination, use the :HCOPY:DESTination command.

Syntax :MMEMory:NAME <file_name>
:MMEMory:NAME?

Arguments <file_name>::=<string> specifies the name of the destination file. The file extension .bmp is added automatically.

Measurement Modes All

Examples :MMEMory:NAME "C:\My Documents\Screen1.bmp"
specifies Screen1.bmp in the My Documents folder as the destination file.

Related Commands :HCOPY:DESTination

:MMEMory:STORe:ACPower (No Query Form)*Option 21 Only*

Stores the ACPR (Adjacent Channel Leakage Power Ratio) measurement results in the specified file in the RFID analysis.

Syntax :MMEMory:STORe:ACPower <file_name>

Arguments <file_name>::=<string> specifies the file in which to store the ACPR measurement results. The file extension is .csv.

Measurement Modes DEMRFID

Examples :MMEMory:STORe:ACPower "C:\My Documents\Result1.csv"
stores the ACPR measurement results in the Result1.csv file in the My Documents folder.

:MMEMory:STORe:CORRection (No Query Form)

Stores the amplitude correction table in the specified file.

Syntax :MMEMory:STORe:CORRection <file_name>

Arguments <file_name>::=<string> specifies the file name.
The file extension is .cor.

Measurement Modes All S/A modes except SARTIME and SAZRTIME

Examples :MMEMory:STORe:CORRection "C:\My Documents\Sample1.cor"
stores the amplitude correction table in the Sample1.cor file in the My Documents folder.

:MMEMory:STORe:IQT (No Query Form)

Stores IQ data in time domain in the specified file.

Syntax :MMEMory:STORe:IQT <file_name>

Arguments <file_name>::=<string> specifies the file in which to store IQ data.
The file extension is .iqt.

Measurement Modes SARTIME, SAZRTIME, all Demod modes, all Time modes

Examples :MMEMory:STORe:IQT "C:\My Documents\Data1.iqt"
stores IQ data in the Data1.iqt file in the My Documents folder.

:MMEMory:STORe:LIMit (No Query Form)

Option 25, 26, 27, and 28

Stores the current limits in the specified file.

Syntax :MMEMory:STORe:LIMit <file_name>

Arguments <file_name>::=<string> specifies the file in which to store the current limits. The file extension is .lmt.

Measurement Modes DEMFLCDMA2K, DEMRLCDMA2K, DEMFL1XEVD0, DEMRL1XEVD0, DEMTD_SCDMA, SADLR5_3G, SAULR5_3G,

Examples :MMEMory:STORe:LIMit "C:\My Documents\Test.lmt"
stores the current limits in the Test.lmt file in the My Documents folder.

:MMEMory:STORe:PULSe (No Query Form)

Stores the pulse measurement results in the specified file.

Syntax :MMEMory:STORe:PULSe <file_name>

Arguments <file_name>::=<string> specifies the file in which to store the pulse measurement results. The file extension is .csv.

Measurement Modes TIMPULSE

Examples :MMEMory:STORe:PULSe "C:\My Documents\Result1.csv"
stores the pulse measurement results in the Result1.csv file in the My Documents folder.

:MMEMory:STORe:RESult:ALLData (No Query Form)

Option 29 Only

Stores Trace 1 and 2 to a specified file in all combinations of the Tx and Rx antennas in the IEEE802.11n (nx1) and MIMO (2x2) analyses. This command is valid when [:SENSe]:M2WLAN:MEASurement is set to ATFunction, PTFunction, DPRofile, EVTime, PVTime, EVSC, PVSC, FERRor, OFLatness, or STABLE.

Syntax :MMEMory:STORe:RESult:ALLData <file_name>

Arguments <file_name>::=<string> specifies the file in which to store the trace data. The file extension is .csv. For the file format, refer to the *RSA3408A Option 29 User Manual*.

Measurement Modes DEMM2WLAN

Examples :MMEMory:STORe:RESult:ALLData "C:\My Documents\Sample.csv"
stores Trace 1 and 2 to the Sample.csv file in the My Documents folder.

Related Commands [:SENSe]:M2WLAN:MEASurement

:MMEMory:STORe:RESult:BOTHtrace (No Query Form)**Option 29 Only**

Stores Trace 1 and 2 in the main view to two files in the IEEE802.11n (nx1) and MIMO (2x2) analyses.

This command is valid when [:SENSe]:M2WLAN[:SWLAN]:MEASurement is set to ATFunction, PTFunction, or DPRofile.

Syntax :MMEMory:STORe:RESult:BOTHtrace <file_name>

Arguments <file_name>::=<string> specifies the file in which to store the trace data. Two files are created with the name of "1" and "2" added to the specified name for Trace 1 and 2, respectively. The file extension is .csv.

Measurement Modes DEMM2WLAN, DEMSWLAN

Examples :MMEMory:STORe:RESult:BOTHtrace "C:\My Documents\Sample.csv"
stores Trace 1 and 2 to the Sample1.csv and Sample2.csv files, respectively.

Related Commands [:SENSe]:M2WLAN[:SWLAN]:MEASurement

:MMEMory:STORe:RESult:NPACkets[:NUMBer](?)

Option 29 Only

Sets or queries the number of packets to save in the IEEE802.11n (nx1) and MIMO (2x2) analyses. Use the :MMEMory:STORe:RESult:POFFset[:NUMBer] command to specify the first packet (packet offset) to save. This command is valid when [:SENSe]:M2WLAN[:SWLAN:MEASurement] is set to ATFunction, PTFfunction, or DPRofile.

Syntax :MMEMory:STORe:RESult:NPACkets[:NUMBer] <number>

 :MMEMory:STORe:RESult:NPACkets[:NUMBer]?

Arguments <number>::=<NR1> specifies the number of packets to save.
Range: 1 to [-(packet offset) + 1].

Measurement Modes DEMM2WLAN, DEMSWLAN

Examples :MMEMory:STORe:RESult:NPACkets:NUMBer 12
 sets the number of packets to 12 to save.

Related Commands :MMEMory:STORe:RESult:POFFset[:NUMBer],
 [:SENSe]:M2WLAN[:SWLAN:MEASurement]

:MMEMory:STORe:RESUlt:ONETrace (No Query Form)

Option 29 Only

Stores Trace 1 in the main view to a specified file in the IEEE802.11n (nx1) and MIMO (2x2) analyses.

This command is valid when [:SENSe]:M2WLAN[:SWLAN]:MEASurement is set to ATFunction, PTFunction, or DPRofile.

Syntax :MMEMory:STORe:RESUlt:ONETrace <file_name>

Arguments <file_name>::=<string> specifies the file in which to store the trace data. The file extension is .csv. For the file format, refer to the *RSA3408A Option 29 User Manual*.

Measurement Modes DEMM2WLAN, DEMSWLAN

Examples :MMEMory:STORe:RESUlt:ONETrace "C:\My Documents\Sample.csv"
stores Trace 1 to the Sample.csv file in the My Documents folder.

Related Commands [:SENSe]:M2WLAN[:SWLAN]:MEASurement

:MMEMory:STORe:RESult:POFFset[:NUMBer](?)

Option 29 Only

Sets or queries the first packet number (packet offset) to store the trace data in the IEEE802.11n (nx1) and MIMO (2x2) analyses. Use the :MMEMory:STORe:RESult:NPACkets[:NUMBer] command to set the number of packets to save. This command is valid when [:SENSe]:M2WLAN[:SWLAN:MEASurement] is set to ATFunction, PTFunction, or DPRofile.

Syntax :MMEMory:STORe:RESult:POFFset[:NUMBer] <number>
 :MMEMory:STORe:RESult:POFFset[:NUMBer] ?

Arguments <number>::=<NR1> specifies the first packet number.
 Range: -[(the number of packets in the analysis range) - 1] to 0.
 Zero (0) represents the latest packet.

Measurement Modes DEMM2WLAN, DEMSWLAN

Examples :MMEMory:STORe:RESult:POFFset:NUMBer -5
 sets the first packet number to -5 to store the trace data.

Related Commands :MMEMory:STORe:RESult:NPACkets[:NUMBer],
 [:SENSe]:M2WLAN[:SWLAN:MEASurement]

:MMEMory:STORe:RESult:TRACe (No Query Form)**Option 29 Only**

Stores the trace data displayed in the main view to a specified file in the IEEE802.11n (nx1) and MIMO (2x2) analyses. This command is valid when [:SENSe]:M2WLAN[:SWLAN]:MEASurement is set to EVTime, PVTime, EVSC, PVSC, FERRor, OFLatness, or STABle.

Syntax :MMEMory:STORe:RESult:TRACe <file_name>

Arguments <file_name>::=<string> specifies the file in which to store the trace data. The file extension is .csv. For the file format, refer to the *RSA3408A Option 29 User Manual*.

Measurement Modes DEMM2WLAN, DEMSWLAN

Examples :MMEMory:STORe:RESult:TRACe "C:\My Documents\Sample.csv"
stores the trace data to the Sample.csv file in the My Documents folder.

Related Commands [:SENSe]:M2WLAN[:SWLAN]:MEASurement

:MMEMory:STORe:RESult:TWOTrace (No Query Form)

Option 29 Only

Stores Trace 2 in the main view to a specified file in the IEEE802.11n (nx1) and MIMO (2x2) analyses.

This command is valid when [:SENSe]:M2WLAN[:SWLAN]:MEASurement is set to ATFunction, PTFfunction, or DPRofile.

Syntax :MMEMory:STORe:RESult:TWOTrace <file_name>

Arguments <file_name>::=<string> specifies the file in which to store the trace data. The file extension is .csv. For the file format, refer to the *RSA3408A Option 29 User Manual*.

Measurement Modes DEMM2WLAN, DEMSWLAN

Examples :MMEMory:STORe:RESult:TWOTrace "C:\My Documents\Sample.csv"
stores Trace 2 to the Sample.csv file in the My Documents folder.

Related Commands [:SENSe]:M2WLAN[:SWLAN]:MEASurement

:MMEMory:STORe:RESult:ITEM(?)**Option 40 Only**

Selects or queries the measurement item to store the results in the 3GPP-R6 modulation analysis.

Syntax :MMEMory:STORe:RESult:ITEM
 { CDPower | CPSYmbol | SEVM | STABLE | MACCuracy }
 :MMEMory:STORe:RESultITEM?

Arguments The table 2-84 shows the measurement items.

Table 2-84: Item to save (Option 40)

Argument	Description
CDPower	Code domain power
CPSYmbol	Code domain power versus Symbol
SEVM	Symbol EVM
STABLE	Symbol table
MACCuracy	Modulation accuracy

Measurement Modes DEMDLR6_3G, DEMULR6_3G

Examples :MMEMory:STORe:RESult:ITEM CDPower
 selects the code domain power measurement to store the result.

:MMEMory:STORe:RESult:MCONtent(?)

Option 40 Only

Selects or queries the measurement content in the symbol EVM measurement. This command is valid when :MMEMory:STORe:RESult:ITEM is set to SEVM.

Syntax :MMEMory:STORe:RESult:MCONtent { EVM | MERRor | PERRor | ALL }
:MMEMory:STORe:RESultMCONtent?

Arguments The table 2-85 shows the measurement items.

Table 2-85: Content to save (Option 40)

Argument	Description
EVM	Symbol EVM
MERRor	Symbol amplitude error
PERRor	Symbol phase error
ALL	All of the above

Measurement Modes DEMDLR6_3G, DEMULR6_3G

Examples :MMEMory:STORe:RESult:MCONtent EVM
selects the symbol EVM as the measurement content.

:MMEMory:STORe:RESult[:SElect] (No Query Form)**Option 40 Only**

Stores the measurement results in the specific file. The measurement item is selected by the :MMEMory:STORe:RESultITEM command.

Syntax :MMEMory:STORe:RESult[:SElect] <file_name>

Arguments <file_name>::=<string> specifies the file to store the measurement results. The file extension is .csv.

Measurement Modes DEMDLR6_3G, DEMULR6_3G

Examples :MMEMory:STORe:RESult:SElect "C:\My Documents\Test.csv"
loads limits from the Test.csv file in the My Documents folder.

Related Commands :MMEMory:STORe:RESultITEM

:MMEMory:STORe:RESult:TSLot:NUMBER(?)**Option 40 Only**

Sets or queries the number of time slots for storing the measurement results.

Syntax :MMEMory:STORe:RESult:TSLot:NUMBER <number>
:MMEMory:STORe:RESult:TSLot:NUMBER?

Arguments <number>::=<NR1> specifies the number of time-slots.
Range: 1 to -(time-slot offset) + 1.

Use the :MMEMory:STORe:RESult:TSLot:OFFSet to set the time-slot offset.

Measurement Modes DEMDLR6_3G, DEMULR6_3G

Examples :MMEMory:STORe:RESult:TSLot:NUMBER 12
sets the number of time slots to 12.

Related Commands :MMEMory:STORe:RESult:TSLot:OFFSet

:MMEMory:STORe:RESult:TSLot:OFFSet(?)

Option 40 Only

Sets or queries the first time-slot for storing the measurement results.

Syntax :MMEMory:STORe:RESult:TSLot:OFFSet <value>
 :MMEMory:STORe:RESult:TSLot:OFFSet?

Arguments <value>: :=<NRf> specifies the time-slot offset.
 Range: -[(the number of time slots in the analysis range) - 1] to 0.
 Zero (0) represents the latest slot.

Measurement Modes DEMDLR6_3G, DEMULR6_3G

Examples :MMEMory:STORe:RESult:TSLot:OFFSet -10
 sets the first time-slot to #-10.

:MMEMory:STORe:STABle (No Query Form)**Option 21, 23, 25, 26, 27, 28, 29, and 40**

Stores the symbol table in the specified file.

NOTE. This command is valid only when the Symbol Table measurement is selected.

Syntax :MMEMory:STORe:STABle <file_name>

Arguments <file_name>::=<string> specifies the file to store the symbol table. The file is in text format, and its extension is .sym.

The file header contents are shown with the communication standard in Table 2-86 and 2-87.

Table 2-86: File header contents - Option 21, 23, 27, 28, and 40

No.	General (Option 21)	W-CDMA (Option 23) 3GPP-R5 (Option 27) 3GPP-R5 (Option 40)	TD-SCDMA (Option 28)
1	Date and time	Date and time	Date and time
2	Modulation	Modulation	Modulation
3	Symbol rate	Symbol rate	Symbol rate
4	Measurement filter	Measurement filter	Measurement filter
5	Reference filter	Reference filter	Subframe number
6	Filter factor (α)	Filter factor (α)	Timeslot number
7	Time from the data end point of the first symbol	Slot number	OVSF code number (max SF)
8		Channelization code number	Sync-DL
9		Time from the data end point of the first symbol	Sync-UL
10			Scrambling code
11			Switching point
12			Timeslot 0 K
13			Other timeslot K
14		Time from the data end point of the first symbol	

Table 2-87: File header contents - Option 25, 26, and 29

No.	cdma2000 (Option 25)	1xEV-DO (Option 26)	WLAN (Option 29)
1	Date and time	Date and time	Date and time
2	Modulation	Modulation	Symbol number (-10^5 to 0)
3	Symbol rate	Symbol rate	Time (-100 to 0 ms)
4	Walsh code length	Walsh code length	Symbol type
5	Walsh code number	Walsh code number	
6	PN offset (FLCDMA2K only)	PN offset (FL1XEVD0 only)	
7	PCG number	Long code mask I (RL1XEVD0 only)	
8	Time from the data end point of the first symbol	Long code mask Q (RL1XEVD0 only)	
9		Channel type (FL1XEVD0 only)	
10		Half slot number	
11		Time from the data end point of the first symbol	

File Header for the RFID Analysis (Option 21).

1. Date and time
2. Burst number
3. Standard type
4. Link
5. Modulation type
6. Decoding format
7. Auto Tari value (for the PIE Type A and C decoding formats)
Auto Bit Rate value (for other than PIE Type A and C decoding formats)
8. Tari value (for the PIE Type A and C decoding formats)
Bit rate value (for other than PIE Type A and C decoding formats)
9. Lower threshold
10. Higher threshold
11. Preamble on/off
12. Preamble length

For Item 2, refer to the View Define menu. For Items 3 to 11, refer to the Meas Setup menu. (Refer to the *RSA3408A User Manual*.)

NOTE. *The date and time saved to the .sym file is the date and time of the last analysis of the symbol table measurement. If the analysis was run on a loaded signal file (filename.iqt), then the date and time in the .sym file will match the loaded .iqt file.*

Measurement Modes

All Demod modes except DEMADEM and DEMGSMEDGE

Examples

:MMEMory:STORe:STABle "C:\My Documents\Data1.sym"
stores symbol table in the Data1.sym file in the My Documents folder.

:MMEMory:STORe:STATe (No Query Form)

Stores the current settings in the specified file.

Syntax :MMEMory:STORe:STATe <file_name>

Arguments <file_name>::=<string> specifies the file in which to store the current settings. The file extension is .cfg.

Measurement Modes All

Examples :MMEMory:STORe:STATe "C:\My Documents\Setup1.cfg"
stores the current settings the Setup1.cfg file in the My Documents folder.

:MMEMory:STORe:TRACe<x> (No Query Form)

Stores Trace 1 or 2 waveform data in the specified file.

Syntax :MMEMory:STORe:TRACe<x> <file_name>

Arguments <file_name> specifies the file in which to store trace data. The file extension is .trc.

Measurement Modes All S/A modes except SARTIME and SAZRTIME

Examples :MMEMory:STORe:TRACe1 "C:\My Documents\Trace1.trc"
stores Trace 1 data in the Trace1.trc file in the My Documents folder.

Related Commands :MMEMory:LOAD:TRACe<x>

:OUTPut Commands

The :OUTPut commands control the characteristics of the analyzer's output port.

Command Tree

Header	Parameter
:OUTPut	
:IQ	
[:STATE]	<Boolean>

:OUTPut:IQ[:STATe](?)

Option 05 Only

Determines whether to enable or disable the digital IQ output data stream from the rear panel connectors.

Syntax :OUTPut:IQ[:STATe] { 0 | 1 | OFF | ON }
 :OUTPut:IQ[:STATe]?

Arguments OFF or 0 disables the digital IQ output.
 ON or 1 enables the digital IQ output.
 At *RST, this value is set to OFF.

Measurement Modes All

Examples :OUTPut:IQ:STATe ON
 enables the digital IQ output.

:PROGrama Commands

The :PROGrama commands control running a macro program.

The macro program to be run must be stored under this directory in the analyzer:

C:\Program Files\Tektronix\wca200a\Python\wca200a\measmacro

For incorporating macro programs into the analyzer, contact your local Tektronix distributor or sales office. For an example of running a macro program, refer to page 4-15.

Command Tree

Header	Parameter
:PROGrama	
:CATalog?	
[:SElected]	
:DElete	
[:SElected]	
:EXECute	<command_name>
:NAME	<macro_name>
:NUMBER	<varname>,<nvalue>
:STRing	<varname>,<nvalue>

:PROGrama:CATalog? (Query Only)

Queries the list of the defined macro programs.

Syntax :PROGrama:CATalog?

Arguments None

Returns Comma-separated character strings as follows:

```
"macro_name{,macro_name}"{"macro_name{,macro_name}"}
```

macro_name represents a macro name.

If no program has been defined, a null character (""") is returned.

Measurement Modes All

Examples :PROGrama:CATalog?
might return "NONREGISTERED.MACROTEST1", "NONREGISTERED.MACROTEST2"
indicating that MacroTest1 and MacroTest2 are located under the directory C:
\Program Files\Tektronix\wca200a\Python\wca200a\measmacro\nonregistered.

:PROGrama[:SElected]:DElete[:SElected] (No Query Form)

Deletes a macro program specified with the :PROGrama[:SElected]:NAME command, from the memory.

Syntax :PROGrama[:SElected]:DElete[:SElected]

Arguments None

Measurement Modes All

Examples :PROGrama:SElected:DElete:SElected
deletes the specified macro program.

Related Commands :PROGrama[:SElected]:NAME

:PROGrama[:SElected]:EXECute (No Query Form)

Runs a command included in the macro program folder specified with the :PROGrama[:SElected]:NAME command.

Syntax :PROGrama[:SElected]:EXECute <command_name>

Arguments <command_name>::=<string> specifies the command.

Returns If the specified command is not found, the following error message is returned:
"Program Syntax error" (-285)

Measurement Modes All

Examples :PROGrama:SElected:EXECute "TEST1"
runs the TEST1 command.

:PROGrama[:SElected]:NAME(?)

Specifies or queries the macro program folder.

Syntax :PROGrama[:SElected]:NAME <macro_name>
:PROGrama[:SElected]:NAME?

Arguments <macro_name>::=<string> specifies the macro program folder.

Returns If the specified macro is not found, the following error message is returned:
"Program Syntax error" (-285)

Measurement Modes All

Examples :PROGrama:SElected:NAME "NONREGISTERED.MACROTEST1"
specifies the macro program folder *MacroTest1* located under the directory C:
|Program Files|Tektronix|wca200a|Python|wca200a|measmacro|nonregistered.

Related Commands :PROGrama[:SElected]:EXECute

:PROGrama:NUMBER(?)

Sets a numeric variable used in the macro program.

The query version of this command returns the numeric variable or the measurement result.

Syntax :PROGrama:NUMBER <varname>,<nvalues>
 :PROGrama:NUMBER? <varname>

Arguments <varname>::=<string> specifies the variable.
 <nvalues>::=<NRf> is the numeric value for the variable.

Returns <NRf> is the numeric value of the specified variable.

If the specified variable is not found, the following error message is returned:

 "Illegal variable name" (-283)

Measurement Modes All

Examples :PROGrama:NUMBER "LOW_LIMIT",1.5
 sets the variable LOW_LIMIT to 1.5.

 :PROGrama:NUMBER? "RESULT"
 might return 1.2345 of the measured value stored in the variable RESULT.

:PROGrama:STRing(?)

Sets a character variable used in the macro program.

The query form of this command returns the character variable or the measurement result (string).

Syntax :PROGrama:STRing <varname>,<svalues>
 :PROGrama:STRing? <varname>

Arguments <varname>::=<string> specifies the variable.
 <svalues>::=<string> is the string for the variable.

Returns <string> of the specified variable.

If the specified variable is not found, the following error message is returned:

 "Illegal variable name" (-283)

Measurement Modes All

Examples :PROGrama:STRing "ERROR_MESSAGE","Measurement Unsuccessful"
 sets the character string "Measurement Unsuccessful" in the variable
 ERROR_MESSAGE.

:READ Commands

The :READ commands acquire an input signal once in the single mode and obtain the measurement results from that data.

If you want to fetch the measurement results from the data currently residing in the memory without acquiring the input signal, use the :FETCh commands.

Invalid data is returned as -1000.

Prerequisites for Use

To use a command of this group, you must have run at least the following two commands:

1. Select a measurement mode using the :INSTRument[:SElect] command. For example, use the following command to select SARTIME (real-time spectrum analysis mode).

```
:INSTRument[:SElect] "SARTIME"
```

2. Set the acquisition mode to single using the following command:

```
:INITiate:CONTinuous OFF
```

NOTE. If a :READ command is run in the continuous mode, the acquisition mode will be changed to single.

Command Tree

Header	Parameter
:READ	
:ADEMod	
:AM?	
:RESult?	
:FM?	
:RESult?	
:PM?	
:PSPectrum?	
:CCDF?	
:DISTRibution:CCDF?	
:OVIew?	
:PULSe?	ALL WIDTH PPOwer OORatio RIPPlE PERiod DCYClE PHASe CHPower OBWidth EBWidth FREQuency
:SPEctrum?	
:TAMPlitude?	
:TFRequency	
:SPEctrum?	
:ACPowEr?	
:CFRequency?	
:CHPower?	
:CNRatio?	
:EBWidth?	
:OBWidth?	
:SPURious?	
:TRANsient	
:FVTime?	
:IQVTime?	
:PVTTime?	

:READ:ADEMod:AM? (Query Only)

Obtains the results of the AM signal analysis in time series.

Syntax :READ:ADEMod:AM?

Arguments None

Returns #<Num_digit><Num_byte><Data(1)><Data(2)>...<Data(n)>

Where

<Num_digit> is the number of digits in <Num_byte>.

<Num_byte> is the number of bytes of the data that follow.

<Data(n)> is the chronological modulation factor data in percent (%).

4-byte little endian floating-point format specified in IEEE 488.2

n: Max 512000 (= 1024 points × 500 frames)

Measurement Modes DEMADEM

Examples :READ:ADEMod:AM?
might return #41024xxxx... (1024-byte data) for the results of the AM signal analysis.

Related Commands :INSTrument[:SElect]

:READ:ADEMod:AM:RESult? (Query Only)

Obtains the measurement results of the AM signal analysis.

Syntax :READ:ADEMod:AM:RESult?

Arguments None

Returns <+AM>,<-AM>,<Total_AM>

Where

<+AM>::=<NRf> is the positive peak AM value in percent (%).

<-AM>::=<NRf> is the negative peak AM value in percent (%).

<Total_AM>::=<NRf> is the total AM value: (peak-peak AM value) / 2 in percent (%).

Measurement Modes DEMADEM

Examples :READ:ADEMod:AM:RESult?
might return 37.34,-48.75,43.04.

Related Commands :INSTRument[:SElect]

:READ:ADEMod:FM? (Query Only)

Obtains the results of the FM signal analysis in time series.

Syntax :READ:ADEMod:FM?

Arguments None

Returns #<Num_digit><Num_byte><Data(1)><Data(2)>...<Data(n)>

Where

<Num_digit> is the number of digits in <Num_byte>.

<Num_byte> is the number of bytes of the data that follow.

<Data(n)> is the chronological frequency shift data in Hz.

4-byte little endian floating-point format specified in IEEE 488.2

n: Max 512000 (= 1024 points × 500 frames)

Measurement Modes DEMADEM

Examples :READ:ADEMod:FM?
might return #41024xxxx... (1024-byte data) for the results of the FM signal analysis.

Related Commands :INSTrument[:SElect]

:READ:ADEMod:FM:RESult? (Query Only)

Obtains the measurement results of the FM signal analysis.

Syntax :READ:ADEMod:FM:RESult?

Arguments None

Returns <+Pk_Freq_Dev>,<-Pk_Freq_Dev>,<P2P_Freq_Dev>,<P2P_Freq_Dev/2>,
 <RMS_Freq_Dev>

Where

<+Pk_Freq_Dev>::=<NRf> is the positive peak frequency deviation in Hz.

<-Pk_Freq_Dev>::=<NRf> is the negative peak frequency deviation in Hz.

<P2P_Freq_Dev>::=<NRf> is the peak-to-peak frequency deviation in Hz.

<P2P_Freq_Dev/2>::=<NRf> is (peak-to-peak frequency deviation) / 2 in Hz.

<RMS_Freq_Dev>::=<NRf> is the RMS frequency deviation in Hz.

Examples :READ:ADEMod:FM:RESult?
 might return 1.13e+4,-1.55e+4,2.48e+4,1.24e+4,1.03e+4.

Related Commands :INSTrument[:SElect]

:READ:ADEMod:PM? (Query Only)

Obtains the results of the PM signal analysis in time series.

Syntax :READ:ADEMod:PM?

Arguments None

Returns #<Num_digit><Num_byte><Data(1)><Data(2)>...<Data(n)>

Where

<Num_digit> is the number of digits in <Num_byte>.

<Num_byte> is the number of bytes of the data that follow.

<Data(n)> is the chronological phase shift data in degrees.

4-byte little endian floating-point format specified in IEEE 488.2

n: Max 512000 (= 1024 points × 500 frames)

Measurement Modes DEMADEM

Examples :READ:ADEMod:PM?
might return #41024xxxx... (1024-byte data) for the results of the PM signal analysis.

Related Commands :INSTrument[:SElect]

:READ:ADEMod:PSpectrum? (Query Only)

Returns spectrum data of the pulse spectrum measurement in the analog modulation analysis.

Syntax :READ:ADEMod:PSpectrum?

Arguments None

Returns #<Num_digit><Num_byte><Data(1)><Data(2)>...<Data(n)>

Where

<Num_digit> is the number of digits in <Num_byte>.

<Num_byte> is the number of bytes of data that follow.

<Data(n)> is the spectrum amplitude in dBm.

4-byte little endian floating-point format specified IEEE 488.2.

n: Max 240001

Measurement Modes DEMADEM

Examples :READ:ADEMod:PSpectrum?
might return #43200xxxx... (3200-byte data) for the spectrum data.

Related Commands :INSTRument[:SElect]

:READ:CCDF? (Query Only)

Obtains the CCDF measurement results.

Syntax :READ:CCDF?

Arguments None

Returns <meanpower>,<peakpower>,<cfactor>

Where

<meanpower>::=<NRf> is the average power measured value in dBm.

<peakpower>::=<NRf> is the peak power measured value in dBm.

<cfactor>::=<NRf> is the crest factor in dB.

Measurement Modes TIMCCDF

Examples :READ:CCDF?
might return -11.16,-8.18,2.96 for the CCDF measurement results.

Related Commands :READ:DISTRibution:CCDF?, :INSTrument[:SElect]

:READ:DISTribution:CCDF? (Query Only)

Returns the CCDF trace data in the CCDF measurement.

Syntax :READ:DISTribution:CCDF?

Arguments None

Returns #<Num_digit><Num_byte><Data(1)><Data(2)>...<Data(n)>

Where

<Num_digit> is the number of digits in <Num_byte>.

<Num_byte> is the number of bytes of the data that follow.

<Data(n)> is the phase shift data in degrees for the point n.

4-byte little endian floating-point format specified in IEEE 488.2

n: Max 10001

Invalid data is returned as -1000.

Measurement Modes TIMCCDF

Examples :READ:DISTribution:CCDF?
might return #41024xxxx... (1024-byte data) for the CCDF trace data in the CCDF measurement.

Related Commands :READ:CCDF?, :INSTrument[:SElect]

:READ:OView? (Query Only)

Obtains the minimum and maximum values for each 1024-point segment of waveform data displayed on the overview in the Demod (modulation analysis) and the Time (time analysis) modes.

NOTE. The :CONFigure:OView command must be run to turn the measurement off before the :READ:OView command is executed.

Syntax :READ:OView?

Returns #<Num_digit><Num_byte><MinData(1)><MaxData(1)>...
<MinData(n)><MaxData(n)>

Where

<Num_digit> is the number of digits in <Num_byte>.

<Num_byte> is the number of bytes of the data that follow.

<MinData(n)> is the minimum data in dBm for each 1024 data point segment.

4-byte little endian floating-point format specified in IEEE 488.2

<MaxData(n)> is the maximum data in dBm for each 1024 data point segment.

4-byte little endian floating-point format specified in IEEE 488.2

n: Max 16000 (standard) / 64000 (Option 02)

Measurement Modes All Demod modes, all Time modes

Examples :READ:OView?
might return #510240xxx... (10240-byte data) representing the minimum and the maximum values of waveform displayed on the overview.

Related Commands :CONFigure:OView, :INSTrument[:SElect]

:READ:PULSe? (Query Only)

Returns the result of the pulse characteristics analysis.

Syntax :READ:PULSe? { ALL | WIDTH | PPOWer | OORatio | RIPPlE | PERiod
| DCYClE | PHASe | CHPower | OBWidth | EBWidth | FREQuency }

Arguments Information queried is listed below for each of the arguments:

Argument	Information queried
ALL	All
WIDTH	Pulse width
PPOWer	Maximum (peak) power in the pulse-on time
OORatio	Difference between the pulse-on time power and off time power
RIPPlE	Difference between the maximum and the minimum power in pulse-on time
PERiod	Time between the pulse rising edge and the next rising edge
DCYClE	Ratio of the pulse width to the pulse repetition interval (PRI)
PHASe	Phase at a certain point of each pulse
CHPower	Channel power of the pulse-on time spectrum
OBWidth	OBW (Occupied Bandwidth) of the pulse-on time spectrum
EBWidth	EBW (Emission Bandwidth) of the pulse-on time spectrum
FREQuency	Carrier frequency in the pulse-on time

Returns Returns are listed below for each of the arguments.

ALL. <width>,<ppower>,<ooratio>,<ripple>,<period>,<dcycle>,<phase>,<chp>,<obw>,<ebw>,<freq>

Where

<width>::=<NRf> is the pulse width in s.

<ppower>::=<NRf> is the peak power in W.

<ooratio>::=<NRf> is the on/off ratio in dB.

<ripple>::=<NRf> is the pulse ripple in watts.

<period>::=<NRf> is the pulse repetition interval in s.

<dcycle>::=<NRf> is the duty cycle in percent (%).

<phase>::=<NRf> is the pulse-pulse phase in degrees.

<chp>::=<NRf> is the channel power in W.

<obw>::=<NRf> is the OBW in Hz.

<ebw>::=<NRf> is the EBW in Hz.

<freq>::=<NRf> is the frequency deviation in Hz.

WIDTH. #<Num_digit><Num_byte><Width(1)><Width(2)>...<Width(n)>

Where

<Num_digit> is the number of digits in <Num_byte>.

<Num_byte> is the number of bytes of the data that follow.

<Width(n)> is the pulse width value for each pulse number.

4-byte little endian floating-point format specified in IEEE 488.2

n: Max 1000

PPower. #<Num_digit><Num_byte><Ppower(1)><Ppower(2)>...<Ppower(n)>

Where

<Num_digit> is the number of digits in <Num_byte>.

<Num_byte> is the number of bytes of the data that follow.

<Power(n)> is the peak power value for each pulse number.

4-byte little endian floating-point format specified in IEEE 488.2

n: Max 1000

OORatio. #<Num_digit><Num_byte><Ooratio(1)><Ooratio(2)>...<Ooratio(n)>

Where

<Num_digit> is the number of digits in <Num_byte>.

<Num_byte> is the number of bytes of the data that follow.

<Ooratio(n)> is the on/off ratio value for each pulse number.

4-byte little endian floating-point format specified in IEEE 488.2

n: Max 1000

RIPPLE. #<Num_digit><Num_byte><Ripple(1)><Ripple(2)>...<Ripple(n)>

Where

<Num_digit> is the number of digits in <Num_byte>.

<Num_byte> is the number of bytes of the data that follow.

<Ripple(n)> is the ripple value for each pulse number.

4-byte little endian floating-point format specified in IEEE 488.2

n: Max 1000

PERiod. #<Num_digit><Num_byte><Period(1)><Period(2)>...<Period(n)>

Where

<Num_digit> is the number of digits in <Num_byte>.

<Num_byte> is the number of bytes of the data that follow.

<Period(n)> is the pulse repetition interval value for each pulse number.

4-byte little endian floating-point format specified in IEEE 488.2

n: Max 1000

DCYClE. #<Num_digit><Num_byte><Dcycle(1)><Dcycle(2)>...<Dcycle(n)>

Where

<Num_digit> is the number of digits in <Num_byte>.

<Num_byte> is the number of bytes of the data that follow.

<Dcycle(n)> is the duty value for each pulse number.

4-byte little endian floating-point format specified in IEEE 488.2

n: Max 1000

PHASe. #<Num_digit><Num_byte><Phase(1)><Phase(2)>...<Phase(n)>

Where

<Num_digit> is the number of digits in <Num_byte>.

<Num_byte> is the number of bytes of the data that follow.

<Phase(n)> is the pulse-pulse phase value for each pulse number.

4-byte little endian floating-point format specified in IEEE 488.2

n: Max 1000

CHPower. #<Num_digit><Num_byte><Chp(1)><Chp(2)>...<Chp(n)>

Where

<Num_digit> is the number of digits in <Num_byte>.

<Num_byte> is the number of bytes of the data that follow.

<Chp(n)> is the Channel Power value for each pulse number.

4-byte little endian floating-point format specified in IEEE 488.2

n: Max 1000

OBWidth. #<Num_digit><Num_byte><Obw(1)><Obw(2)>...<Obw(n)>

Where

<Num_digit> is the number of digits in <Num_byte>.

<Num_byte> is the number of bytes of the data that follow.

<Obw(n)> is the OBW value for each pulse number.

4-byte little endian floating-point format specified in IEEE 488.2

n: Max 1000

EBWidth. #<Num_digit><Num_byte><Ebw(1)><Ebw(2)>...<Ebw(n)>

Where

<Num_digit> is the number of digits in <Num_byte>.

<Num_byte> is the number of bytes of the data that follow.

<Ebw(n)> is the EBW value for each pulse number.

4-byte little endian floating-point format specified in IEEE 488.2

n: Max 1000

FREQUENCY. #<Num_digit><Num_byte><Freq(1)><Freq(2)>...<Freq(n)>

Where

<Num_digit> is the number of digits in <Num_byte>.

<Num_byte> is the number of bytes of the data that follow.

<Freq(n)> is the carrier frequency value for each pulse number.

4-byte little endian floating-point format specified in IEEE 488.2

n: Max 1000

Measurement Modes TIMPULSE

Examples :READ:PULSe? WIDTH
might return #3500xxxx... (500-byte data) for the pulse width measurement result.

Related Commands :INSTrument[:SElect]

:READ:PULSe:SPECTrum? (Query Only)

Returns the spectrum data of the frequency domain measurement in the pulse characteristics analysis.

This query command is valid when :DISPlay:PULSe:SVIew:FORMat is set to CHPowr, OBWidth, or EBWidth.

Syntax :READ:PULSe:SPECTrum?

Arguments None

Returns #<Num_digit><Num_byte><Data(1)><Data(2)>...<Data(n)>

Where

<Num_digit> is the number of digits in <Num_byte>.

<Num_byte> is the number of bytes of data that follow.

<Data(n)> is the spectrum in dBm.

4-byte little endian floating-point format specified IEEE 488.2.

n: Max 16384

Measurement Modes TIMPULSE

Examples :READ:PULSe:SPECTrum?
might return #43200xxxx... (3200-byte data) for the spectrum data.

Related Commands :DISPlay:PULSe:SVIew:FORMat, :INSTrument[:SElect]

:READ:PULSe:TAMPlitude? (Query Only)

Returns the time domain amplitude data of the time domain measurement in the pulse characteristics analysis.

This query command is valid when :DISPlay:PULSe:SVIew:FORMat is set to WIDTH, PPOWer, OORatio, RIPPlE, PERiod, DCYClE, or PHASe.

Syntax :READ:PULSe:TAMPlitude?

Arguments None

Returns #<Num_digit><Num_byte><Data(1)><Data(2)>...<Data(n)>

Where

<Num_digit> is the number of digits in <Num_byte>.

<Num_byte> is the number of bytes of data that follow.

<Data(n)> is the absolute power for each data in watts.

4-byte little endian floating-point format specified IEEE 488.2.

n: Max 262,144

Invalid data is returned as -1000.

Measurement Modes TIMPULSE

Examples :READ:PULSe:TAMPlitude?
might return #43200xxxx... (3200-byte data) for the time domain amplitude.

Related Commands :DISPlay:PULSe:SVIew:FORMat, :INSTrument[:SElect]

:READ:PULSe:TFrequency? (Query Only)

Returns the frequency deviation measurement results in the pulse characteristics analysis.

This query command is valid when :DISPlay:PULSe:SVIew:FORMat is set to FREQuency.

Syntax :READ:PULSe:TFrequency?

Arguments None

Returns #<Num_digit><Num_byte><Data(1)><Data(2)>...<Data(n)>

Where

<Num_digit> is the number of digits in <Num_byte>.

<Num_byte> is the number of bytes of data that follow.

<Data(n)> is the frequency deviation value in Hz on the time axis.

4-byte little endian floating-point format specified IEEE 488.2.

n: Max 262,144

Invalid data is returned as -1000.

Measurement Modes TIMPULSE

Examples :READ:PULSe:TFrequency?
might return #43200xxxx... (3200-byte data) for the time domain frequency.

Related Commands :DISPlay:PULSe:SVIew:FORMat, :INSTrument[:SElect]

:READ:SPECTrum? (Query Only)

Obtains spectrum waveform data in the S/A (spectrum analysis) mode.

Syntax :READ:SPECTrum?

Arguments None

Returns #<Num_digit><Num_byte><Data(1)><Data(2)>...<Data(n)>

Where

<Num_digit> is the number of digits in <Num_byte>.

<Num_byte> is the number of bytes of the data that follow.

<Data(n)> is the amplitude spectrum in dBm.

4-byte little endian floating-point format specified in IEEE 488.2

n: Max 400000 (= 800 points × 500 frames)

Measurement Modes SANORMAL, SASGRAM, SARTIME, SAZRTIME, SAUL3G

Examples :READ:SPECTrum?
might return #43200xxxx... (3200-byte data) for the spectrum waveform data.

Related Commands :INSTrument[:SElect]

:READ:SPECTrum:ACPower? (Query Only)

Obtains the results of the adjacent channel leakage power ratio (ACPR) measurement in the S/A mode.

Syntax :READ:SPECTrum:ACPower?

Arguments None

Returns <chpower>,<acpm1>,<acpp1>,<acpm2>,<acpp2>,<acpm3>,<acpp3>

Where

<chpower>::=<NRf> is the channel power measured value in dBm.

<acpm1>::=<NRf> is the first lower adjacent channel ACPR in dB.

<acpp1>::=<NRf> is the first upper adjacent channel ACPR in dB.

<acpm2>::=<NRf> is the second lower adjacent channel ACPR in dB.

<acpp2>::=<NRf> is the second upper adjacent channel ACPR in dB.

<acpm3>::=<NRf> is the third lower adjacent channel ACPR in dB.

<acpp3>::=<NRf> is the third upper adjacent channel ACPR in dB.

NOTE. All the values may not be returned when the adjacent channel(s) goes out of the span due to the settings of the channel bandwidth and spacing (refer to the [:SENSe]:ACPower subgroup). For example, if the third adjacent channel goes out of the span, the response is <chpower>,<acpm1>,<acpp1>,<acpm2>,<acpp2>; <acpm3> and <acpp3> are not returned.

Measurement Modes SANORMAL, SASGRAM, SARTIME, SAUL3G

Examples :READ:SPECTrum:ACPower?
might return -11.38,-59.41,-59.51,-59.18,-59.31,-59.17,-59.74 for the ACPR measurement results.

Related Commands :INSTrument[:SElect], [:SENSe]:ACPower subgroup

:READ:SPECTrum:CFrequency? (Query Only)

Obtains the results of the carrier frequency measurement in the S/A mode.

Syntax :READ:SPECTrum:CFrequency?

Arguments None

Returns <cfreq>::=<NRf> is the measured value of the carrier frequency in Hz.

Measurement Modes SANORMAL, SASGRAM, SARTIME, SAUL3G

Examples :READ:SPECTrum:CFrequency?
might return 846187328.5 for the carrier frequency.

Related Commands :INSTrument[:SElect]

:READ:SPECTrum:CHPower? (Query Only)

Obtains the results of the channel power measurement in the S/A mode.

Syntax :READ:SPECTrum:CHPower?

Arguments None

Returns <chpower>::=<NRf> is the channel power measured value in dBm.

Measurement Modes SANORMAL, SASGRAM, SARTIME, SAUL3G

Examples :READ:SPECTrum:CHPower?
might return -1.081 for the measurement results of the channel power.

Related Commands :INSTrument[:SElect]

:READ:SPECTrum:CNRatio? (Query Only)

Obtains the results of the carrier-to-noise ratio (C/N) measurement in the S/A (spectrum analysis) mode.

Syntax :READ:SPECTrum:CNRatio?

Arguments None

Returns <ctn>,<ctno>

Where

<ctn>::=<NRf> is the measured value of C/N in dB.

<ctno>::=<NRf> is the measured value of C/No in dB/Hz.

Measurement Modes SANORMAL, SASGRAM, SARTIME, SAUL3G

Examples :READ:SPECTrum:CNRatio?
might return 75.594,125.594 for the C/N measurement results.

Related Commands :INSTrument[:SElect]

:READ:SPECTrum:EBWidth? (Query Only)

Obtains the results of the emission bandwidth (EBW) measurement in the S/A (spectrum analysis) mode.

Syntax :READ:SPECTrum:EBWidth?

Arguments None

Returns <ebw>::=<Nrf> is the measured value of EBW in Hz.

Measurement Modes SANORMAL, SASGRAM, SARTIME, SAUL3G

Examples :READ:SPECTrum:EBWidth?
might return 30956.26 for the EBW measurement results.

Related Commands :INSTrument[:SElect]

:READ:SPECTrum:OBWidth? (Query Only)

Obtains the results of the occupied bandwidth (OBW) measurement in the S/A (spectrum analysis) mode.

Syntax :READ:SPECTrum:OBWidth?

Arguments None

Returns <obw>::=<Nrf> is the measured value of OBW in Hz.

Measurement Modes SANORMAL, SASGRAM, SARTIME, SAUL3G

Examples :READ:SPECTrum:OBWidth?
might return 26510.163 for the OBW measurement results.

Related Commands :INSTrument[:SElect]

:READ:SPECTrum:SPURious? (Query Only)

Obtains the results of the spurious signal measurement in the S/A (spectrum analysis) mode.

Syntax :READ:SPECTrum:SPURious?

Arguments None

Returns <snum>{,<dfreq>,<rdb>}

Where

<snum>::=<NR1> is the number of detected spurious emissions, max. 20

<dfreq>::=<NRf> is the detuned frequency of spurious relative to carrier in Hz.

<rdb>::=<NRf> is the relative level of spurious signal to carrier in dB.

Measurement Modes SANORMAL, SASGRAM, SARTIME

Examples :READ:SPECTrum:SPURious?
might return 3,1.2E6,-79,2.4E6,-79.59,1E6,-80.38 for the spurious signal measurement.

Related Commands :INSTRument[:SElect]

:READ:TRANSient:FVTime? (Query Only)

Obtains the results of the frequency vs. time measurement in the Time (time analysis) mode.

Syntax :READ:TRANSient:FVTime?

Arguments None

Returns #<Num_digit><Num_byte><Data(1)><Data(2)>...<Data(n)>

Where

<Num_digit> is the number of digits in <Num_byte>.

<Num_byte> is the number of bytes of the data that follow.

<Data(n)> is the chronological frequency data in Hz.

4-byte little endian floating-point format specified in IEEE 488.2

n: Max 512000 (= 1024 points × 500 frames)

Measurement Modes TIMTRAN

Examples :READ:TRANSient:FVTime?
might return #41024xxxx... (1024-byte data) for the results of the frequency vs. time measurement.

Related Commands :INSTrument[:SElect]

:READ:TRANSient:IQVTime? (Query Only)

Obtains the results of the IQ level vs. time measurement in the Time (time analysis) mode.

Syntax :READ:TRANSient:IQVTime?

Arguments None

Returns #<Num_digit><Num_byte><Idata(1)><Qdata(1)>
<Idata(2)><Qdata2>...<Idata(n)><Qdata(n)>

Where

<Num_digit> is the number of digits in <Num_byte>.

<Num_byte> is the number of bytes of the data that follow.

<Idata(n)><Qdata(n)> is the I and Q signal level data in volts.

4-byte little endian floating-point format specified in IEEE 488.2

n: Max 512000 (= 1024 points × 500 frames)

Measurement Modes TIMTRAN

Examples :READ:TRANSient:IQVTime?
might return #41024xxxx... (1024-byte data) for the results of the
IQ level vs. time measurement.

Related Commands :INSTrument[:SElect]

:READ:TRANSient:PVTime? (Query Only)

Obtains the results of the power measurement vs. time in the Time (time analysis) mode.

Syntax :READ:TRANSient:PVTime?

Arguments None

Returns #<Num_digit><Num_byte><Data(1)><Data(2)>...<Data(n)>

Where

<Num_digit> is the number of digits in <Num_byte>.

<Num_byte> is the number of bytes of the data that follow.

<Data(n)> is the chronological power data in dBm.

4-byte little endian floating-point format specified in IEEE 488.2

n: Max 512000 (= 1024 points × 500 frames)

Measurement Modes TIMTRAN

Examples :READ:TRANSient:PVTime?
might return #41024xxxx... (1024-byte data) for the results of the power vs. time measurement.

Related Commands :INSTrument[:SElect]

:READ Commands (Option)

This section describes the :READ commands for optional analysis software as shown in Table 2-88.

Table 2-88: :READ command subgroups (Option)

Command header	Function	Refer to:
Option 21 Advanced measurement suite related		
:READ:DDEMod	Returns the results of the digital modulation analysis.	page 2-947
:READ:RFID	Returns the results of the RFID analysis.	page 2-953
:READ:SSource	Returns the results of the signal source analysis.	page 2-958
Option 23 W-CDMA analysis related		
:READ:AC3Gpp	Returns the results of the ACLR measurement.	page 2-962
Option 24 GSM/EDGE analysis related		
:READ:GSMedge	Returns the results of the GSM/EDGE analysis.	page 2-963
Option 25 cdma2000 analysis related		
:READ:FLCDMA2K RLCDMA2K	Returns the results of the cdma2000 analysis.	page 2-974
Option 26 1xEV-DO analysis related		
:READ:FL1XEVD0 RL1XEVD0	Returns the results of the 1xEV-DO analysis.	page 2-988
Option 27 3GPP-R5 analysis related		
:READ:SADLR5_3GPP SAULR5_3GPP	Returns the results of the 3GPP-R5 spectrum analysis.	page 2-1002
Option 28 TD-SCDMA analysis related		
:READ:TD_SCDMA	Returns the results of the TD-SCDMA analysis.	page 2-1017
Option 29 WLAN analysis related		
:READ:SWLAN	Returns the results of the IEEE802.11n SISO analysis.	page 2-1028
:READ:WLAN	Returns the results of the IEEE802.11a/b/g analysis.	page 2-1030

Prerequisites for Use

To use a command of this group, you must have run at least the following two commands:

1. Select a measurement mode using the :INSTrument[:SElect] command. For example, use the following command to select SARTIME (real-time spectrum analysis mode).

```
:INSTrument[:SElect] "SARTIME"
```

2. Set the acquisition mode to single using the following command:

```
:INITiate:CONTInuous OFF
```

NOTE. *If a :READ command is run in the continuous mode, the acquisition mode will be changed to single.*

:READ:DDEMod Subgroup***Modulation Analysis, Option 21 Only***

The :FETCh:DDEMod commands return the results of the digital modulation analysis.

Command Tree	Header	Parameter
	:READ	
	:DDEMod?	IQVTime FVTime CONStE EVM AEVM PEVM MERRor AMERRor PMERRor PERRor APERRor PPERror RHO SLENgth FERRor OOFFset STABle PVTime AMAM AMPM CCDF PDF RMSError FDEVIation

:READ:DDEMod? (Query Only)

Obtains the results of the digital modulation analysis.

Syntax :READ:DDEMod? { IQVTime | FVTime | CONSte | EVM | AEVM | PEVM
| MERRor | AMERRor | PMERRor | PERRor | APERRor | PPERror | RHO
| SLENgth | FERRor | OOFFset | STABle | PVTime | AMAM | AMPM
| CCDF | PDF | RMSError | FDEVIation }

Arguments Information queried is listed below for each of the arguments:

Table 2-89: Queried information on the digital modulation analysis results

Argument	Information queried
IQVTime	IQ level versus Time measured value
FVTime	Frequency versus Time measured value (for FSK demodulation only)
CONSte	Constellation measurement results (coordinates data array of symbols)
EVM	Error Vector Magnitude (EVM) measurement results
AEVM	EVM RMS value
PEVM	EVM peak value and its symbol number
MERRor	Amplitude error
AMERRor	Amplitude error RMS value
PMERRor	Amplitude error peak value and its symbol number
PERRor	Phase error
APERRor	Phase error RMS value
PPERror	Phase error peak value and its symbol number
RHO	Value of waveform quality (ρ)
SLENgth	Number of analyzed symbols
FERRor	Frequency error
OOFFset	Origin offset value (Not available when [:SENSe]:DDEMod:FORMat is set to ASK, FSK or GFSK)
STABle	Data from symbol table
PVTime	Power versus Time (Valid when [:SENSe]:DDEMod:FORMat is set to ASK)
AMAM	AM/AM measurement results
AMPM	AM/PM measurement results
CCDF	CCDF measurement results
PDF	PDF measurement results

Table 2-89: Queried information on the digital modulation analysis results (Cont.)

Argument	Information queried
RMSError	Frequency error RMS value (Valid when [:SENSe]:DDEMod:FORMat is set to C4FM)
FDEviation	Frequency deviation (Valid when [:SENSe]:DDEMod:FORMat is set to C4FM)

Returns Returns are listed below for each of the arguments. You can select degrees or radians for the angular unit using the :UNIT:ANGLE command.

IQVTime. #<Num_digit><Num_byte><Idata(1)><Qdata(1)>
<Idata(2)><Qdata2>...<Idata(n)><Qdata(n)>

Where

<Num_digit> is the number of digits in <Num_byte>.

<Num_byte> is the number of bytes of data that follow.

<Idata(n)><Qdata(n)> is the I and Q signal level data in volts.

4-byte little endian floating-point format specified in IEEE 488.2

n: Max 512000 (= 1024 points × 500 frames)

FVTime. #<Num_digit><Num_byte><Data(1)><Data(2)>...<Data(n)>

Where

<Num_digit> is the number of digits in <Num_byte>.

<Num_byte> is the number of bytes of data that follow.

<Data(n)> is the frequency shift data in Hz for the point n.

4-byte little endian floating-point format specified in IEEE 488.2

n: Max 512000 (= 1024 points × 500 frames)

CONSt. #<Num_digit><Num_byte><Ip(1)><Qp(1)>...<Ip(n)><Qp(n)>

Where

<Num_digit> is the number of digits in <Num_byte>.

<Num_byte> is the number of bytes of data that follow.

<Ip(n)> is the sample position on the I axis in a normalized value.

<Qp(n)> is the sample position on the Q axis in a normalized value.

Both <Ip(n)> and <Qp(n)> are in the 4-byte little endian floating-point format specified in IEEE 488.2. n: Max 512000 (= 1024 points × 500 frames)

EVM. #<Num_digit><Num_byte><Evm(1)><Evm(2)>...<Evm(n)>

Where

<Num_digit> is the number of digits in <Num_byte>.

<Num_byte> is the number of bytes of data that follow.

<Evm(n)> is the value of symbol EVM in percent (%).

4-byte little endian floating-point format specified in IEEE 488.2

n: Max 512000 (= 1024 points × 500 frames)

AEVM. <aevm>::=<NRf> is the EVM RMS value in percent (%).

PEVM. <pevm>,<symb>

Where

<pevm>::=<NRf> is the EVM peak value in percent (%).

<symb>::=<NR1> is the symbol number for the EVM peak value.

MERRor. #<Num_digit><Num_byte><Merr(1)><Merr(2)>...<Merr(n)>

Where

<Num_digit> is the number of digits in <Num_byte>.

<Num_byte> is the number of bytes of data that follow.

<Merr(n)> is the value of amplitude error of symbol in percent (%).

4-byte little endian floating-point format specified in IEEE 488.2

n: Max 512000 (= 1024 points × 500 frames)

AMERror. <amer>::=<NRf> is the amplitude error RMS value in percent (%).

PMERror. <pmer>,<symb>

Where

<pmer>::=<NRf> is the amplitude error peak value in percent (%).

<symb>::=<NR1> is the symbol number for the amplitude error peak value.

PERRor. #<Num_digit><Num_byte><Perr(1)><Perr(2)>...<Perr(n)>

Where

<Num_digit> is the number of digits in <Num_byte>.

<Num_byte> is the number of bytes of data that follow.

<Perr(n)> is the value of phase error of symbol in degrees or radians.

4-byte little endian floating-point format specified in IEEE 488.2

n: Max 512000 (= 1024 points × 500 frames)

APERror. <aper>::=<NRf> is the phase error RMS in degrees or radians.

PPERror. <pper>, <symb>

Where

<pper>::=<NRf> is the phase error peak value in degrees or radians.

<symb>::=<NRf> is the symbol number for the phase error peak value.

RHO. <rho>::=<NRf> is the measured value of waveform quality (ρ).

SLEngh. <slen>::=<NR1> is the number of analyzed symbols.

FERRor. <ferr>::=<NRf> is the frequency error in Hz.

OOFFset. <ooff>::=<NRf> is the origin offset in dB.

STABLE. #<Num_digit><Num_byte><Sym(1)><Sym(2)>...<Sym(n)>

Where

<Num_digit> is the number of digits in <Num_byte>.

<Num_byte> is the number of bytes of data that follow.

<Sym(n)>::=<NR1> is the symbol data.

n: Max 512000 (= 1024 points \times 500 frames)

PVTime. #<Num_digit><Num_byte><Data(1)><Data(2)>...<Data(n)>

Where

<Num_digit> is the number of digit in <Num_byte>.

<Num_byte> is the number of bytes of data that follow.

<Data(n)> is the time domain power data in dBm.

4-byte little endian floating-point format specified IEEE 488.2.

n: Max 512000 (= 1024 points \times 500 frames)

AMAM. <Comp>, <Coeff_num>{, <Coeff>}

Where

<Comp>::=<NRf> is the 1 dB compression point in dBm.

<Coeff_num>::=<NR1> is the number of coefficients (1 to 16).

It is equal to the value set using the [:SENSe]:DDEMod:NLINearity:COEFFicient command plus 1.

<Coeff>::=<NRf> is the coefficient value.

AMPM. <Coeff_num>{,<Coeff>}

Where

<Coeff_Num>::=<NR1> is the number of coefficients (1 to 16).

It is equal to the value set using the [:SENSe]:DDEMod:NLINearity:COEFFi-
cient command plus 1.

<Coeff>::=<NRf> is the coefficient value.

CCDF. <Mean_Power_D>,<Peak_Power_D>,<Crest_Factor_D>,
<Mean_Power_R>,<Peak_Power_R>,<Crest_Factor_R>

Where

<Mean_Power_D>::=<NRf> is the measured average power in dBm.

<Peak_Power_D>::=<NRf> is the measured peak power in dBm.

<Crest_Factor_D>::=<NRf> is the measured crest factor in dB.

<Mean_Power_R>::=<NRf> is the reference average power in dBm.

<Peak_Power_R>::=<NRf> is the reference peak power in dBm.

<Crest_Factor_R>::=<NRf> is the reference crest factor in dB.

PDF. <Mean_Power_D>,<Peak_Power_D>,<Mean_Power_R>,<Peak_Power_R>

Where

<Mean_Power_D>::=<NRf> is the measured average power in dBm.

<Peak_Power_D>::=<NRf> is the measured peak power in dBm.

<Mean_Power_R>::=<NRf> is the reference average power in dBm.

<Peak_Power_R>::=<NRf> is the reference peak power in dBm.

RMSError. <RMSError>::=<NRf> is the RMS frequency error in Hz.

FDEviation. <FDeviation>::=<NRf> is the frequency deviation in Hz.

Measurement Modes DEMDDEM

Examples :READ:DDEMod? IQVTime
might return #41024xxxx... (1024-byte data) for the IQ level versus time
measurement results.

Related Commands :INSTrument[:SELEct], [:SENSe]:DDEMod:FORMat, :UNIT:ANGLE

:READ:RFID Subgroup

RFID Analysis, Option 21 Only

The :READ:RFID commands return the results of the RFID (Radio Frequency Identification) analysis.

Command Tree	Header	Parameter
	:READ	
	:RFID	
	:ACPower?	
	:SPURious?	
	:SPECTrum	
	:ACPower?	
	:SPURious?	

:READ:RFID:ACPower? (Query Only)

Returns the results of the ACPR (Adjacent Channel leakage Power Ratio) measurement in the RFID analysis.

Syntax :READ:RFID:ACPower?

Arguments None

Returns <Count>{,<Ofrequency>,<Upper>,<Lower>}

Where

<Count>::=<NR1> is the count of data sets that follow (0 to 25).

<Ofrequency>::=<NRf> is the offseet frequency in Hz.

<Upper>::=<NRf> is the ACPR for the nth upper adjacent channel in dBc.

<Lower>::=<NRf> is the ACPR for the nth lower adjacent channel in dBc.

Measurement Modes DEMRFID

Examples :READ:RFID:ACPower?
might return 2,500E+3,-38.45,-38.43,1E+6,-44.14,-44.11 for the ACPR measurement result.

Related Commands :INSTrument[:SElect]

:READ:RFID:SPURious? (Query Only)

Returns the results of the spurious signal measurement in the RFID analysis.

Syntax :READ:RFID:SPURious?

Arguments None

Returns <Snum>{,<Dfreq>,<Rdbc>}

Where

<Snum>::=<NR1> is the number of detected spurious emissions. Max. 20.

<Dfreq>::=<NRf> is the detuned frequency of spurious relative to carrier in Hz.

<Rdbc>::=<NRf> is the spurious signal level relative to carrier in dBc.

Measurement Modes DEMRFID

Examples :READ:RFID:SPURious?
might return 2,-468.75E+3,-45.62,787.5E+3,-49.88 for the spurious measurement result.

Related Commands :INSTrument[:SElect]

:READ:RFID:SPECTrum:ACPower? (Query Only)

Returns spectrum waveform data of the ACPR (Adjacent Channel leakage Power Ratio) measurement in the RFID analysis.

Syntax :READ:RFID:SPECTrum:ACPower?

Arguments None

Returns #<Num_digit><Num_byte><Data(1)><Data(2)>...<Data(n)>

Where

<Num_digit> is the number of digits in <Num_byte>.

<Num_byte> is the number of bytes of data that follow.

<Data(n)> is the amplitude of the spectrum in dBm.

4-byte little endian floating-point format specified in IEEE 488.2.

n: Max 240001

Measurement Modes DEMRFID

Examples :READ:RFID:SPECTrum:ACPower?
might return #43200xxxx... (3200-byte data) for the spectrum data.

Related Commands :INSTrument[:SElect]

:READ:RFID:SPECTrum:SPURious? (Query Only)

Returns spectrum waveform data of the spurious measurement in the RFID analysis.

Syntax :READ:RFID:SPECTrum:SPURious?

Arguments None

Returns #<Num_digit><Num_byte><Data(1)><Data(2)>...<Data(n)>

Where

<Num_digit> is the number of digits in <Num_byte>.

<Num_byte> is the number of bytes of data that follow.

<Data(n)> is the amplitude of the spectrum in dBm.

4-byte little endian floating-point format specified in IEEE 488.2.

n: Max 240001

Measurement Modes DEMRFID

Examples :READ:RFID:SPECTrum:SPURious?
might return #43200xxxx... (3200-byte data) for the spectrum data.

Related Commands :INSTrument[:SElect]

:READ:SSource Subgroup

Signal Source Analysis, Option 21 Only

The :READ:SSource commands return the results of the signal source analysis.

Command Tree	Header	Parameter
	:READ	
	:SSource?	PNOise SPURious FVTime
	:SPECTrum?	
	:TRANsient	
	:FVTime?	

:READ:SSource? (Query Only)

Returns the result of the selected measurement in the signal source analysis.

Syntax :READ:SSource? { PNOise | SPURious | FVTime }

Arguments The arguments indicate the measurements as shown in Table 2-90.

Table 2-90: Signal source analysis

Argument	Measurement
PNOise	Phase noise
SPURious	Spurious
FVTime	Frequency versus Time

Returns Returns are listed below for each of the arguments:

PNOise. <Cfreq>, <Cpower>, <IP_Noise>, <Rj>, <Max_Pj>

Where

<Cfreq>::=<NRf> is the carrier frequency in Hz.

<Cpower>::=<NRf> is the channel power in dBm.

<IP_Noise>::=<NRf> is the integrated phase noise in radians or degrees

<Rj>::=<NRf> is the random jitter in seconds.

<Max_Pj>::=<NRf> is the maximum periodic jitter in seconds.

SPURious. <snum>{, <dfreq>, <rdb>}

Where

<snum>::=<NR1> is the number of detected spurious signals (max. 20)

<dfreq>::=<NRf> is the detuned frequency of spurious relative to carrier in Hz.

<rdb>::=<NRf> is the spurious signal level relative to carrier in dBc.

FVTime. <Fstime>, <Fsstart>, <Fsstop>, <TFstime>, <Tfsstart>, <Tfsstop>

Where

<Fstime>::=<NRf> is the frequency settling time.

<Fsstart>::=<NRf> is the frequency settling time start.

<Fsstop>::=<NRf> is the frequency settling time stop.

<TFstime>::=<NRf> is the frequency settling time from trigger.

<Tfsstart>::=<NRf> is the frequency settling time start from trigger.

<Tfsstop>::=<NRf> is the frequency settling time stop from trigger

Unit: All in seconds.

Measurement Modes TIMSSOURCE

Examples :READ:SSource? PNOise
might return 2.0E+9, -21.430, 12.432E-12, 8.95, 217.725E-12 for the phase noise measurement result.

:READ:SSource:SPECTrum? (Query Only)

Returns spectrum waveform data of the frequency domain measurement in the signal source analysis.

This commands is valid when [:SENSE]:SSource:MEASurement is set to PNOise, SPURious, or RTSPurious.

Syntax :READ:SSource:SPECTrum?

Arguments None

Returns #<Num_digit><Num_byte><Data(1)><Data(2)>...<Data(n)>

Where

<Num_digit> is the number of digits in <Num_byte>.

<Num_byte> is the number of bytes of data that follow.

<Data(n)> is the amplitude of the spectrum in dBm.

4-byte little endian floating-point format specified in IEEE 488.2.

n: Max 240001

Measurement Modes TIMSSOURCE

Examples :READ:SSource:SPECTrum?
might return #43200xxxx... (3200-byte data) for the spectrum data.

Related Commands [:SENSE]:SSource:MEASurement

:READ:SSource:TRANSient:FVTime? (Query Only)

Returns the frequency versus time measurement results in the signal source analysis.

Syntax :READ:SSource:TRANSient:FVTime?

Arguments None

Returns #<Num_digit><Num_byte><Data(1)><Data(2)>...<Data(n)>

Where

<Num_digit> is the number of digits in <Num_byte>.

<Num_byte> is the number of bytes of data that follow.

<Data(n)> is the frequency deviation value in Hz on the time axis.

4-byte little endian floating-point format specified in IEEE 488.2.

n: Max 512000 (1024 points × 500 frames)

Measurement Modes TIMSSOURCE

Examples :READ:SSource:TRANSient:FVTime?
might return #43200xxxx... (3200-byte data) for the frequency versus time measurement results.

:READ:AC3Gpp Subgroup

W-CDMA Analysis, Option 23 Only

The :READ:AC3Gpp commands return the results of the W-CDMA ACLR measurement.

Command Tree	Header	Parameter
	:READ	
	:AC3Gpp	
	:ACLR?	

:READ:AC3Gpp:ACLR? (Query Only)

Obtains the measurement results of the W-CDMA ACLR (Adjacent Channel Leakage Power Ratio) analysis.

Syntax :READ:AC3Gpp:ACLR?

Arguments None

Returns <chpower>,<ac1rm1>,<ac1rp1>,<ac1rm2>,<ac1rp2>

Where

<chpower>::=<NRf> is the channel power measured value in dBm.

<ac1rm1>::=<NRf> is the first lower adjacent channel ACLR in dB.

<ac1rp1>::=<NRf> is the first upper adjacent channel ACLR in dB.

<ac1rm2>::=<NRf> is the second lower adjacent channel ACLR in dB.

<ac1rp2>::=<NRf> is the second upper adjacent channel ACLR in dB.

Measurement Modes SAUL3G

Examples :READ:AC3Gpp:ACLR?
might return -1.081, -68.420, -68.229, -74.506, -74.462 for the W-CDMA ACLR measurement results.

Related Commands :INSTRument[:SElect]

:READ:GSMedge Subgroup***GSM/EDGE Analysis, Option 24 Only***

The :READ:GSMedge commands return the results of the GSM/EDGE analysis.

Command Tree	Header	Parameter
	:READ	
	:GSMedg	
	:MACCuracy?	
	:MCPower?	
	:MODulation?	
	:PVTime?	
	:SPECTrum	
	:MODulation?	
	:SWITching?	
	:SPURious?	
	:SWITching?	
	:TAMPitude	
	:MCPower?	
	:PVTime?	

:READ:GSMedge:MACCuracy? (Query Only)

Obtains the results of the GSM/EDGE modulation accuracy measurement for the burst specified using the [:SENSe]:GSMedge:BURSt:INDeX command.

Syntax :READ:GSMedge:MACCuracy?

Arguments None

Returns <pass_fail>,<phase_error>,<peak_phase_error>,<evm>,<evm95>,<peak_evm>,<freq_error>,<o_off>

Where

<pass_fail>::=<NR1> = 0 represents Fail; = 1 represents Pass.

<phase_error>::=<NRf> is the phase error in degrees.

<peak_phase_error>::=<NRf> is the peak phase error in degrees.

<evm>::=<NRf> is the EVM (Error Vector Magnitude) in percent (%).

<evm95>::=<NRf> is the EVM 95% tile in percent (%).

<peak_evm>::=<NRf> is the peak EVM in percent (%).

<freq_error>::=<NRf> is the frequency error in Hz.

<o_off>::=<NRf> is the origin offset in dB.

<pass_fail> returns 1 (one) when the test is disabled.

Measurement Modes DEMGSMEDGE

Examples :READ:GSMedge:MACCuracy?
might return 1,0.47,0.86,0.93,0.75,2.15,4.209,-64.31 as the modulation accuracy measurement results.

Related Commands :INSTRument[:SElect], [:SENSe]:GSMedge:BURSt:INDeX

:READ:GSMedge:MCPower? (Query Only)

Obtains the results of the GSM/EDGE mean carrier power measurement for the burst specified using the [:SENSE]:GSMedge:BURSt:INDex command.

Syntax :READ:GSMedge:MCPower?

Arguments None

Returns <mean_power>,<max_power>,<max_bi>,<min_power>,<min_bi>

Where

<mean_power>::=<NRf> is the mean power value in dBm.

<max_power>::=<NRf> is the maximum power value in dBm.

<max_bi>::=<NR1> is the burst index for the maximum power.

<min_power>::=<NRf> is the minimum power value in dBm.

<min_bi>::=<NR1> is the burst index for the minimum power.

Measurement Modes DEMGSMEDGE

Examples :READ:GSMedge:MCPower?
might return 68.081,72.4203,3,58.229,7 as the mean carrier power measurement results.

Related Commands :INSTrument[:SElect], [:SENSE]:GSMedge:BURSt:INDex

:READ:GSMedge:MODulation? (Query Only)

Queries the pass/fail result of the GSM/EDGE modulation spectrum measurement for the standard specified using the [:SENSe]:GSMedge:STANdard commands.

Syntax :READ:GSMedge:MODulation?

Arguments None

Returns <NR1> = 0 indicates Fail.
 <NR1> = 1 indicates Pass.

Measurement Modes DEMGSMEDGE

Examples :READ:GSMedge:MODulation?
 might return 1, indicating that the modulation spectrum measurement has passed.

Related Commands :INSTrument[:SElect], [:SENSe]:GSMedge:STANdard

:READ:GSMedge:PVTime? (Query Only)

Queries the pass/fail result of the GSM/EDGE power versus time measurement for the burst specified using the [:SENSe]:GSMedge:BURSt:INDeX command.

Syntax :READ:GSMedge:PVTime?

Arguments None

Returns <NR1> = 0 indicates Fail.
<NR1> = 1 indicates Pass.

Measurement Modes DEMGSMEDGE

Examples :READ:GSMedge:PVTime?
might return 1, indicating that the power versus time measurement has passed.

Related Commands :INSTrument[:SElect], [:SENSe]:GSMedge:BURSt:INDeX

:READ:GSMedge:SPECTrum:MODulation? (Query Only)

Returns waveform data of the GSM/EDGE modulation spectrum measurement for the burst specified using the [:SENSe]:GSMedge:BURSt:INDex command.

Syntax :READ:GSMedge:SPECTrum:MODulation?

Returns #<Num_digit><Num_byte><Data(1)><Data(2)>...<Data(n)>

Where

<Num_digit> is the number of digits in <Num_byte>.

<Num_byte> is the number of bytes of the data that follow.

<Data(n)> is the modulation spectrum power data in dBm.

4-byte little endian floating-point format specified in IEEE 488.2

n: Max 240001

Measurement Modes DEMGSMEDGE

Examples :READ:GSMedge:SPECTrum:MODulation?
might return #510240xxx... (10240-byte data) as the results of the modulation spectrum measurement.

Related Commands :INSTrument[:SELEct], [:SENSe]:GSMedge:BURSt:INDex

:READ:GSMedge:SPECTrum:SWITching? (Query Only)

Returns waveform data of the GSM/EDGE switching spectrum measurement for the burst specified using the [:SENSe]:GSMedge:BURSt:INDEx command.

Syntax :READ:GSMedge:SPECTrum:SWITching?

Returns #<Num_digit><Num_byte><Data(1)><Data(2)>...<Data(n)>

Where

<Num_digit> is the number of digits in <Num_byte>.

<Num_byte> is the number of bytes of the data that follow.

<Data(n)> is the switching spectrum power data in dBm.

4-byte little endian floating-point format specified in IEEE 488.2

n: Max 240001

Measurement Modes DEMGSMEDGE

Examples :READ:GSMedge:SPECTrum:SWITching?
might return #510240xxx... (10240-byte data) as the results of the switching spectrum measurement.

Related Commands :INSTrument[:SElect], [:SENSe]:GSMedge:BURSt:INDEx

:READ:GSMedge:SPURious? (Query Only)

Returns the results of the GSM/EDGE spurious measurement for the standard specified using the [:SENSe]:GSMedge:STANdard commands. The values of frequency and level are returned for maximum 10 peaks that exceeded the standard level in ascending order.

Syntax :READ:GSMedge:SPURious?

Arguments None

Returns <num>{,<freq>,<rdb>}

Where

<num>::=<NR1> is the number of detected spurious signals, up to 10.

<freq>::=<NRf> is the frequency of spurious in Hz.

<rdb>::=<NRf> is the level of spurious in dBm.

Measurement Modes DEMGSMEDGE

Examples :READ:GSMedge:SPURious?
might return 3,1.2E6,-79,2.4E6,-79.59,1E6,-80.38.

Related Commands :INSTrument[:SELEct], [:SENSe]:GSMedge:STANdard

:READ:GSMedge:SWITching? (Query Only)

Queries the pass/fail result of the GSM/EDGE switching spectrum measurement for the standard specified using the [:SENSE]:GSMedge:STANdard commands.

Syntax :READ:GSMedge:SWITching?

Arguments None

Returns <NR1> = 0 indicates Fail.
<NR1> = 1 indicates Pass.

Measurement Modes DEMGSMEDGE

Examples :READ:GSMedge:SWITching?
might return 1, indicating that the switching spectrum measurement has passed.

Related Commands :INSTrument[:SElect], [:SENSE]:GSMedge:STANdard

:READ:GSMedge:TAMplitude:MCPower? (Query Only)

Obtains the time domain amplitude data of the GSM/EDGE mean carrier power measurement for the burst specified using the [:SENSE]:GSMedge:BURSt:INDEX command.

Syntax :READ:GSMedge:TAMplitude:MCPower?

Returns #<Num_digit><Num_byte><Data(1)><Data(2)>...<Data(n)>

Where

<Num_digit> is the number of digits in <Num_byte>.

<Num_byte> is the number of bytes of the data that follow.

<Data(n)> is the absolute power for each symbol in dBm.

4-byte little endian floating-point format specified in IEEE 488.2

n: Max 512000 (= 1024 points × 500 frames)

Invalid data is returned as -1000.

Measurement Modes DEMGSMEDGE

Examples :READ:GSMedge:TAMplitude:MCPower?
might return #510240xxx... (10240-byte data) for the results of the mean carrier power measurement.

Related Commands :INSTrument[:SElect], [:SENSE]:GSMedge:BURSt:INDEX

:READ:GSMedge:TAMplitude:PVTime? (Query Only)

Obtains the time domain amplitude data of the GSM/EDGE power versus time measurement for the time slot specified using the [:SENSE]:GSMedge:BURSt:INDEX command.

Syntax :READ:GSMedge:TAMplitude:PVTime?

Returns #<Num_digit><Num_byte><Data(1)><Data(2)>...<Data(n)>

Where

<Num_digit> is the number of digits in <Num_byte>.

<Num_byte> is the number of bytes of the data that follow.

<Data(n)> is the absolute power for each symbol in dBm.

4-byte little endian floating-point format specified in IEEE 488.2

n: Max 512000 (= 1024 points × 500 frames)

Invalid data is returned as -1000.

Measurement Modes DEMGSMEDGE

Examples :READ:GSMedge:TAMplitude:PVTime?
might return #510240xxx... (10240-byte data) as the results of the power versus time measurement.

Related Commands :INSTrument[:SElect], [:SENSE]:GSMedge:BURSt:INDEX

:READ:FLCDMA2K|:RLCDMA2K Subgroup

cdma2000 Analysis, Option 25 Only

The :READ:FLCDMA2K|:RLCDMA2K commands return the results of the cdma2000 analysis.

Command Tree	Header	Parameter
	:READ	
	:FLCDMA2K :RLCDMA2K	
	:ACPower?	
	:CCDF?	
	:CHPower?	
	:DISTribution	
	:CCDF?	
	:IM?	
	:OBWidth?	
	:PVTime?	
	:SEMAsk?	
	:SPECTrum	
	:ACPower?	
	:CHPower?	
	:IM?	
	:OBWidth?	
	:TAMPliitude	
	:PVTime?	

NOTE. There are no :READ subsystems for :CDPower?, :MACCuracy?, and :PCCHannel? commands. To retrieve the measurement results, execute the [:SENSe]:FLCDMA2K|:RLCDMA2K[:IMMEDIATE] command.

:READ:FLCDMA2K|:RLCDMA2K:ACPower? (Query Only)

Returns the results of the ACPR measurement under the cdma2000 forward link or reverse link standard.

Syntax :READ:FLCDMA2K|:RLCDMA2K:ACPower?

Arguments None

Returns <pass_fail>,<chpower>,<acpr1>,<acpr2>,<acpr3>,<acpr4>,<acpr5>,<acpr6>,<acpr7>,<acpr8>,<acpr9>,<acpr10>,<acpr11>,<acpr12>

Where

<pass_fail>::={ 1 | 0 } is the measurement result; 1: Pass or 0: Fail.

<chpower>::=<NRf> is the channel power measured value in dBm.

<acpr1>::=<NRf> is the first adjacent channel ACPR in dBc.

<acpr2>::=<NRf> is the second adjacent channel ACPR in dBc.

.

.

.

<acpr12>::=<NRf> is the twelfth adjacent channel ACPR in dBc.

<pass_fail> returns 1 (one) when the test is disabled.

Measurement Modes DEMFLCDMA2K, DEMRLCDMA2K

Examples :READ:FLCDMA2K:ACPower?
might return 0,-2.045E+001,-6.461E+001,-4.379E+001,-6.576E+001,-6.753E+001,-6.79E+001,-1.0E+038,-1.0E+038,-1.0E+038,-1.0E+038,-1.0E+038,-1.0E+038,-1.0E+038,-1.0E+038 for the ACPR measurement under the cdma2000 forward link standard.

Related Commands :INSTrument[:SELect]

:READ:FLCDMA2K|:RLCDMA2K:CCDF? (Query Only)

Returns the results of the CCDF measurement under the cdma2000 forward link or reverse link standard.

Syntax :READ:FLCDMA2K|:RLCDMA2K:CCDF?

Arguments None

Returns <Mean_power>,<Peak_power>,<Crest_factor>

Where

<Mean_power>::=<NRf> is the average power in dBm.

<Peak_power>::=<NRf> is the peak power in dBm.

<Crest_factor>::=<NRf> is the crest factor in dB.

Measurement Modes DEMFLCDMA2K, DEMRLCDMA2K

Examples :READ:FLCDMA2K:CCDF?
might return -1.757E+001,-9.53E+000,8.04E+000 for the CCDF measurement under the cdma2000 forward link standard.

Related Commands :INSTRument[:SELect]

:READ:FLCDMA2K|:RLCDMA2K:CHPower? (Query Only)

Returns the results of the channel power measurement under the cdma2000 forward link or reverse link standard.

Syntax :READ:FLCDMA2K|:RLCDMA2K:CHPower?

Arguments None

Returns <pass_fail>,<chpower>,<power_density>

Where

<pass_fail>::={ 1 | 0 } is the measurement result; 1: Pass or 0: Fail.

<Chpower>::=<Nrf> is the channel power measured value in dBm.

<Power_density>::=<Nrf> is the power density measured value in dBm/Hz.

<pass_fail> returns 1 (one) when the test is disabled.

Measurement Modes DEMFLCDMA2K, DEMRLCDMA2K

Examples :READ:FLCDMA2K:CHPower?
might return 1,-2.0339E+001,-8.1238E+001 for the channel power measurement under the cdma2000 forward link standard.

Related Commands :INSTrument[:SElect]

:READ:FLCDMA2K|:RLCDMA2K:DISTriBution:CCDF? (Query Only)

Returns the distribution data of the CCDF measurement under the cdma2000 forward link or reverse link standard.

Syntax :READ:FLCDMA2K|:RLCDMA2K:DISTriBution:CCDF?

Arguments None

Returns #<Num_digit><Num_byte><Data(1)><Data(2)>...<Data(n)>

Where

<Num_digit> is the number of digits in <Num_byte>.

<Num_byte> is the number of bytes of the data that follow.

<Data(n)> is the absolute power for each symbol in dBm.

Four-byte little endian floating-point format specified IEEE 488.2.

n: Max 10001

Invalid data is returned as -1000.

Measurement Modes DEMFLCDMA2K, DEMRLCDMA2K

Examples :READ:FLCDMA2K:DISTriBution:CCDF?
might return #510240xxx... (10240-byte data) as the results of the CCDF measurement under the cdma2000 forward link standard.

Related Commands :INSTRument[:SElect]

:READ:FLCDMA2K|:RLCDMA2K:IM? (Query Only)

Returns the results of the intermodulation measurement under the cdma2000 forward link or reverse link standard.

Syntax :READ:FLCDMA2K|:RLCDMA2K:IM?

Arguments None

Returns <pass_fail>,<L_channel>,<U_channel>,<L3_lower>,<L3_upper>,<U3_lower>,<U3_upper>,<L5_lower>,<L5_upper>,<U5_lower>,<U5_upper>

Where

<pass_fail>::={ 1 | 0 } is the measurement result; 1: Pass or 0: Fail.

<L_channel>::=<NRf> is the lower channel measured value in dBm.

<U_channel>::=<NRf> is the upper channel measured value in dBm.

<L3_lower>::=<NRf> is the lower third order (lower) measured value in dBc.

<L3_upper>::=<NRf> is the lower third order (upper) measured value in dBc.

<U3_lower>::=<NRf> is the upper third order (lower) measured value in dBc.

<U3_upper>::=<NRf> is the upper third order (upper) measured value in dBc.

<L5_lower>::=<NRf> is the lower fifth order (lower) measured value in dBc.

<L5_upper>::=<NRf> is the lower fifth order (upper) measured value in dBc.

<U5_lower>::=<NRf> is the upper fifth order (lower) measured value in dBc.

<U5_upper>::=<NRf> is the upper fifth order (upper) measured value in dBc.

When each value is not present, the value of -1000 is returned.

<pass_fail> returns 1 (one) when the test is disabled.

Measurement Modes DEMFLCDMA2K, DEMRLCDMA2K

Examples :READ:FLCDMA2K:IM?
might return 1,-2.061E+001,-5.501E+001,-1.66E+001,1.78E+001,-4.76E+001,-1.32E+001,-4.73E+001,-1.29E+001,-5.1E+001,-1.66E+001
for the intermodulation measurement under the cdma2000 forward link standard.

Related Commands :INSTrument[:SElect]

:READ:FLCDMA2K|:RLCDMA2K:OBWidth? (Query Only)

Returns the results of the occupied bandwidth measurement under the cdma2000 forward link or reverse link standard.

Syntax :READ:FLCDMA2K|:RLCDMA2K:OBWidth?

Arguments None

Returns <pass_fail>,<obw>

Where

<pass_fail>::={ 1 | 0 } is the measurement result; 1: Pass or 0: Fail.

<obw>::=<NRf> is the occupied bandwidth in Hz.

<pass_fail> returns 1 (one) when the test is disabled.

Measurement Modes DEMFLCDMA2K, DEMRLCDMA2K

Examples :READ:FLCDMA2K:OBWidth?
might return 1,1.27333E+006 for the OBW measurement under the cdma2000 forward link standard.

Related Commands :INSTrument[:SElect]

:READ:RLCDMA2K:PVTime? (Query Only)

Returns the results of the gated output power measurement under the cdma2000 reverse link standard.

Syntax :READ:RLCDMA2K:PVTime?

Arguments None

Returns <pass_fail>

Where

<pass_fail>::={ 1 | 0 } is the measurement result; 1: Pass or 0: Fail.

<pass_fail> returns 1 (one) when the test is disabled.

Measurement Modes DEMRLCDMA2K

Examples :READ:RLCDMA2K:PVTime?
might return 1, indicating that the gated output power measurement has passed.

Related Commands :INSTrument[:SElect]

:READ:FLCDMA2K|RLCDMA2K:SEMask? (Query Only)

Returns the results of the spectrum emission mask measurement under the cdma2000 forward link or reverse link standard.

Syntax :READ:FLCDMA2K|RLCDMA2K:SEMask?

Arguments None

Returns <pass_fail>

Where

<pass_fail>::={ 1 | 0 } is the measurement result; 1: Pass or 0: Fail.

<pass_fail> returns 1 (one) when the test is disabled.

Measurement Modes DEMFLCDMA2K, DEMRLCDMA2K

Examples :READ:FLCDMA2K:SEMask?
might return 1, indicating that the spectrum emission mask measurement has passed.

Related Commands :INSTrument[:SElect]

:READ:FLCDMA2K|:RLCDMA2K:SPECTrum:ACPower? (Query Only)

Returns the spectrum waveform data of the ACPR measurement under the cdma2000 forward link or reverse link standard.

Syntax :READ:FLCDMA2K|:RLCDMA2K:SPECTrum:ACPower?

Arguments None

Returns #<Num_digit><Num_byte><Data(1)><Data(2)>...<Data(n)>

Where

<Num_digit> is the number of digits in <Num_byte>.

<Num_byte> is the number of bytes of the data that follow.

<Data(n)> is the spectrum amplitude in dBm.

Four-byte little endian floating-point format specified IEEE 488.2.

n: Max 240001

Invalid data is returned as -1000.

Measurement Modes DEMFLCDMA2K, DEMRLCDMA2K

Examples :READ:FLCDMA2K:SPECTrum:ACPower?
might return #510240xxx... (10240-byte data) as the spectrum waveform data of the ACPR measurement under the cdma2000 forward link standard.

Related Commands :INSTrument[:SElect]

:READ:FLCDMA2K|:RLCDMA2K:SPECTrum:CHPower? (Query Only)

Returns the spectrum waveform data of the channel power measurement under the cdma2000 forward link or reverse link standard.

Syntax :READ:FLCDMA2K|:RLCDMA2K:SPECTrum:CHPower?

Arguments None

Returns #<Num_digit><Num_byte><Data(1)><Data(2)>...<Data(n)>

Where

<Num_digit> is the number of digits in <Num_byte>.

<Num_byte> is the number of bytes of the data that follow.

<Data(n)> is the spectrum amplitude in dBm.

Four-byte little endian floating-point format specified IEEE 488.2.

n: Max 240001

Invalid data is returned as -1000.

Measurement Modes DEMFLCDMA2K, DEMRLCDMA2K

Examples :READ:FLCDMA2K:SPECTrum:CHPower?
might return #510240xxx... (10240-byte data) as the spectrum waveform data of the channel power measurement under the cdma2000 forward link standard.

Related Commands :INSTrument[:SELect]

:READ:FLCDMA2K|:RLCDMA2K:SPECTrum:IM? (Query Only)

Returns the spectrum waveform data of the intermodulation measurement under the cdma2000 forward link or reverse link standard.

Syntax :READ:FLCDMA2K|:RLCDMA2K:SPECTrum:IM?

Arguments None

Returns #<Num_digit><Num_byte><Data(1)><Data(2)>...<Data(n)>

Where

<Num_digit> is the number of digits in <Num_byte>.

<Num_byte> is the number of bytes of the data that follow.

<Data(n)> is the spectrum amplitude in dBm.

Four-byte little endian floating-point format specified IEEE 488.2.

n: Max 240001

Invalid data is returned as -1000.

Measurement Modes DEMFLCDMA2K, DEMRLCDMA2K

Examples :READ:FLCDMA2K:SPECTrum:IM?
might return #510240xxx... (10240-byte data) as the spectrum waveform data of the intermodulation measurement under the cdma2000 forward link standard.

Related Commands :INSTrument[:SElect]

:READ:FLCDMA2K|:RLCDMA2K:SPECTrum:OBWidth? (Query Only)

Returns the spectrum waveform data of the occupied bandwidth measurement under the cdma2000 forward link or reverse link standard.

Syntax :READ:FLCDMA2K|:RLCDMA2K:SPECTrum:OBWidth?

Arguments None

Returns #<Num_digit><Num_byte><Data(1)><Data(2)>...<Data(n)>

Where

<Num_digit> is the number of digits in <Num_byte>.

<Num_byte> is the number of bytes of the data that follow.

<Data(n)> is the spectrum amplitude in dBm.

Four-byte little endian floating-point format specified IEEE 488.2.

n: Max 240001

Invalid data is returned as -1000.

Measurement Modes DEMFLCDMA2K, DEMRLCDMA2K

Examples :READ:FLCDMA2K:SPECTrum:OBWidth?
might return #510240xxx... (10240-byte data) as the spectrum waveform data of the occupied bandwidth measurement under the cdma2000 forward link standard.

Related Commands :INSTRument[:SElect]

:READ:RLCDMA2K:TAMplitude:PVTime? (Query Only)

Returns the time domain amplitude data of the gated output power measurement under the cdma2000 reverse link standard.

Syntax :READ:RLCDMA2K:TAMplitude:PVTime?

Arguments None

Returns #<Num_digit><Num_byte><Data(1)><Data(2)>...<Data(n)>

Where

<Num_digit> is the number of digits in <Num_byte>.

<Num_byte> is the number of bytes of the data that follow.

<Data(n)> is the absolute power for each symbol in dBm.

Four-byte little endian floating-point format specified IEEE 488.2.

n: Max 512000 (= 1024 points × 500 frames)

Invalid data is returned as -1000.

Measurement Modes DEMRLCDMA2K

Examples :READ:RLCDMA2K:TAMplitude:PVTime?
might return #510240xxx... (1024-byte data) as the results of the gated output power measurement under the cdma2000 reverse link standard.

Related Commands :INSTrument[:SElect]

:READ:FL1XEVD0|:RL1XEVD0 Subgroup

1xEV-DO Analysis, Option 26 Only

The :READ:FL1XEVD0|:RL1XEVD0 commands return the results of the 1xEV-DO analysis.

Command Tree	Header	Parameter
	:READ	
	:FL1XEVD0 :RL1XEVD0	
	:ACPower?	
	:CCDF?	
	:CHPower?	
	:DISTribution	
	:CCDF?	
	:IM?	
	:OBWidth?	
	:PVTime?	
	:SEMask?	
	:SPECTrum	
	:ACPower?	
	:CHPower?	
	:IM?	
	:OBWidth?	
	:TAMPliitude	
	:PVTime?	

NOTE. There are no :READ subsystems for :CDPower?, :MACCuracy?, and :PCCHannel? commands. To retrieve the measurement results, execute the [:SENSe]:Standard[:IMMediate] command.

:READ:FL1XEVD0|:RL1XEVD0:ACPower? (Query Only)

Obtains the results of the ACPR measurement under the 1xEV-DO forward link or reverse link standard.

Syntax :READ:FL1XEVD0|:RL1XEVD0:ACPower?

Arguments None

Returns <pass_fail>,<Chpower>,<Acpr1>,<Acpr2>,<Acpr3>,<Acpr4>,<Acpr5>,<Acpr6>,<Acpr7>,<Acpr8>,<Acpr9>,<Acpr10>,<Acpr11>,<Acpr12>

Where

<pass_fail>::={ 1 | 0 } is the measurement result; 1: Pass or 0: Fail.

<Chpower>::=<NRf> is the channel power measured value in dBm.

<Acpr1>::=<NRf> is the first adjacent channel ACPR in dBc.

<Acpr2>::=<NRf> is the second adjacent channel ACPR in dBc.

.

.

.

<Acpr12>::=<NRf> is the twelfth adjacent channel ACPR in dBc.

<pass_fail> returns 1 (one) when the test is disabled.

Measurement Modes DEMFL1XEVD0, DEMRL1XEVD0

Examples :READ:FL1XEVD0:ACPower?
might return 0,-2.048E+001,-6.29E+001,-4.248E+001,-6.526E+001,-6.607E+001,-6.79E+001,-1.0E+038,-1.0E+038,-1.0E+038,-1.0E+038,-1.0E+038,-1.0E+038,-1.0E+038,-1.0E+038 for the ACPR measurement under the 1xEV-DO forward link measurement.

Related Commands :INSTrument[:SELect]

:READ:FL1XEVD0|:RL1XEVD0:CCDF? (Query Only)

Obtains the results of the CCDF measurement under the 1xEV-DO forward link or reverse link standard.

Syntax :READ:FL1XEVD0|:RL1XEVD0:CCDF?

Arguments None

Returns <Mean_power>,<Peak_power>,<Crest_factor>

Where

<Mean_power>::=<NRf> is the average power in dBm.

<Peak_power>::=<NRf> is the peak power in dBm.

<Crest_factor>::=<NRf> is the crest factor in dB.

Measurement Modes DEMFL1XEVD0, DEMRL1XEVD0

Examples :READ:FL1XEVD0:CCDF?
might return -2.043E+001,-9.75E+000,1.068E+001 for the CCDF measurement under the 1xEV-DO forward link measurement.

Related Commands :INSTRument[:SElect]

:READ:FL1XEVD0|:RL1XEVD0:CHPower? (Query Only)

Obtains the results of the channel power measurement under the 1xEV-DO forward link or reverse link standard.

Syntax :READ:FL1XEVD0|:RL1XEVD0:CHPower?

Arguments None

Returns <pass_fail>,<Chpower>,<Power_density>

Where

<pass_fail>::={ 1 | 0 } is the measurement result; 1: Pass or 0: Fail.

<Chpower>::=<NRf> is the channel power measured value in dBm.

<Power_density>::=<NRf> is the power density measured value in dBm/Hz.

<pass_fail> returns 1 (one) when the test is disabled.

Measurement Modes DEMFL1XEVD0, DEMRL1XEVD0

Examples :READ:FL1XEVD0:CHPower?
might return 1,-2.0375E+001,-8.1274E+001 for the channel power measurement under the 1xEV-DO forward link measurement.

Related Commands :INSTrument[:SElect]

:READ:FL1XEVD0|:RL1XEVD0:DISTriBution:CCDF? (Query Only)

Obtains the distribution data of the CCDF measurement under the 1xEV-DO forward link or reverse link standard.

Syntax :READ:FL1XEVD0|:RL1XEVD0:DISTriBution:CCDF?

Arguments None

Returns #<Num_digit><Num_byte><Data(1)><Data(2)>...<Data(n)>

Where

<Num_digit> is the number of digits in <Num_byte>.

<Num_byte> is the number of bytes of the data that follow.

<Data(n)> is the absolute power for each symbol in dBm.

Four-byte little endian floating-point format specified IEEE 488.2.

n: Max 10001

Invalid data is returned as -1000.

Measurement Modes DEMFL1XEVD0, DEMRL1XEVD0

Examples :READ:FL1XEVD0:DISTriBution:CCDF?
might return #510240xxx... (10240-byte data) as the results of the CCDF measurement under the 1xEV-DO forward link standard.

Related Commands :INSTRument[:SELect]

:READ:FL1XEVD0|:RL1XEVD0:IM? (Query Only)

Obtains the results of the intermodulation measurement under the 1xEV-DO forward link or reverse link standard.

Syntax :READ:FL1XEVD0|:RL1XEVD0:IM?

Arguments None

Returns <pass_fail>,<L_channel>,<U_channel>,<L3_lower>,<L3_upper>,<U3_lower>,<U3_upper>,<L5_lower>,<L5_upper>,<U5_lower>,<U5_upper>

Where

<pass_fail>::={1|0} is the measurement result; 1: Pass or 0: Fail.

<L_channel>::=<NRf> is the lower channel measured value in dBm.

<U_channel>::=<NRf> is the upper channel measured value in dBm.

<L3_lower>::=<NRf> is the lower third order (lower) measured value in dBc.

<L3_upper>::=<NRf> is the lower third order (upper) measured value in dBc.

<U3_lower>::=<NRf> is the upper third order (lower) measured value in dBc.

<U3_upper>::=<NRf> is the upper third order (upper) measured value in dBc.

<L5_lower>::=<NRf> is the lower fifth order (lower) measured value in dBc.

<L5_upper>::=<NRf> is the lower fifth order (upper) measured value in dBc.

<U5_lower>::=<NRf> is the upper fifth order (lower) measured value in dBc.

<U5_upper>::=<NRf> is the upper fifth order (upper) measured value in dBc.

When each value is not present, the value of -1000 is returned.

<pass_fail> returns 1 (one) when the test is disabled.

Measurement Modes DEMFL1XEVD0, DEMRL1XEVD0

Examples :READ:FL1XEVD0:IM?
might return 1,-2.058E+001,-5.446E+001,-1.68E+001,1.71E+001,-4.76E+001,-1.37E+001,-4.73E+001,-1.34E+001,-5.11E+001,-1.72E+001 for the intermodulation measurement under the 1xEV-DO forward link standard.

Related Commands :INSTrument[:SElect]

:READ:FL1XEVD0|:RL1XEVD0:OBWidth? (Query Only)

Obtains the results of the occupied bandwidth measurement under the 1xEV-DO forward link or reverse link standard.

Syntax :READ:FL1XEVD0|:RL1XEVD0:OBWidth?

Arguments None

Returns <pass_fail>,<obw>

Where

<pass_fail>::={ 1 | 0 } is the measurement result; 1: Pass or 0: Fail.

<obw>::=<NRf> is the measured value of the occupied bandwidth in Hz.

<pass_fail> returns 1 (one) when the test is disabled.

Measurement Modes DEMFL1XEVD0, DEMRL1XEVD0

Examples :READ:FL1XEVD0:OBWidth?
might return 1,1.26763E+006 for the occupied bandwidth measurement results.

Related Commands :INSTrument[:SElect]

:READ:FL1XEVD0:PVTime? (Query Only)

Obtains the results of the gated output power measurement under the 1xEV-DO forward link standard.

Syntax :READ:FL1XEVD0:PVTime?

Arguments None

Returns <pass_fail>

Where

<pass_fail>::={ 1 | 0 } is the measurement result; 1: Pass or 0: Fail.

<pass_fail> returns 1 (one) when the test is disabled.

Measurement Modes DEMFL1XEVD0

Examples :READ:FL1XEVD0:PVTime?
might return 1, indicating that the gated output power measurement has passed.

Related Commands :INSTrument[:SElect]

:READ:FL1XEVD0|:RL1XEVD0:SEMask? (Query Only)

Obtains the results of the spectrum emission mask measurement under the 1xEV-DO forward link or reverse link standard.

Syntax :READ:FL1XEVD0|:RL1XEVD0:SEMask?

Arguments None

Returns <pass_fail>

Where

<pass_fail>::={ 1 | 0 } is the measurement result; 1: Pass or 0: Fail.

<pass_fail> returns 1 (one) when the test is disabled.

Measurement Modes DEMFL1XEVD0

Examples :READ:FL1XEVD0:SEMask?
might return 1, indicating that the spectrum emission mask measurement has passed.

Related Commands :INSTRument[:SElect]

:READ:FL1XEVD0|:RL1XEVD0:SPECTrum:ACPower? (Query Only)

Obtains the spectrum waveform data of the ACPR measurement under the 1xEV-DO forward link or reverse link standard.

Syntax :READ:FL1XEVD0|:RL1XEVD0:SPECTrum:ACPower?

Arguments None

Returns #<Num_digit><Num_byte><Data(1)><Data(2)>...<Data(n)>

Where

<Num_digit> is the number of digits in <Num_byte>.

<Num_byte> is the number of bytes of the data that follow.

<Data(n)> is the spectrum amplitude in dBm.

Four-byte little endian floating-point format specified IEEE 488.2.

n: Max 240001

Invalid data is returned as -1000.

Measurement Modes DEMFL1XEVD0, DEMRL1XEVD0

Examples :READ:FL1XEVD0:SPECTrum:ACPower?
might return #510240xxx... (10240-byte data) as the spectrum waveform data of the ACPR measurement under the 1xEV-DO forward link standard.

Related Commands :INSTrument[:SElect]

:READ:FL1XEVD0|:RL1XEVD0:SPECTrum:CHPower? (Query Only)

Obtains the spectrum waveform data of the channel power measurement under the 1xEV-DO forward link or reverse link standard.

Syntax :READ:FL1XEVD0|:RL1XEVD0:SPECTrum:CHPower?

Arguments None

Returns #<Num_digit><Num_byte><Data(1)><Data(2)>...<Data(n)>

Where

<Num_digit> is the number of digits in <Num_byte>.

<Num_byte> is the number of bytes of the data that follow.

<Data(n)> is the spectrum amplitude in dBm.

Four-byte little endian floating-point format specified IEEE 488.2.

n: Max 240001

Invalid data is returned as -1000.

Measurement Modes DEMFL1XEVD0, DEMRL1XEVD0

Examples :READ:FL1XEVD0:SPECTrum:CHPower?
might return #510240xxx... (10240-byte data) as the spectrum waveform data of the channel power measurement under the 1xEV-DO forward link standard.

Related Commands :INSTRument[:SElect]

:READ:FL1XEVD0|:RL1XEVD0:SPECTrum:IM? (Query Only)

Obtains the spectrum waveform data of the intermodulation measurement under the 1xEV-DO forward link or reverse link standard.

Syntax :READ:FL1XEVD0|:RL1XEVD0:SPECTrum:IM?

Arguments None

Returns #<Num_digit><Num_byte><Data(1)><Data(2)>...<Data(n)>

Where

<Num_digit> is the number of digits in <Num_byte>.

<Num_byte> is the number of bytes of the data that follow.

<Data(n)> is the spectrum amplitude in dBm.

Four-byte little endian floating-point format specified IEEE 488.2.

n: Max 240001

Invalid data is returned as -1000.

Measurement Modes DEMFL1XEVD0, DEMRL1XEVD0

Examples :READ:FL1XEVD0:SPECTrum:IM?
might return #510240xxx... (10240-byte data) as the spectrum waveform data of the intermodulation measurement under the 1xEV-DO forward link standard.

Related Commands :INSTrument[:SElect]

:READ:FL1XEVD0|:RL1XEVD0:SPECTrum:OBWidth? (Query Only)

Obtains the spectrum waveform data of the occupied bandwidth measurement under the 1xEV-DO forward link or reverse link standard.

Syntax :READ:FL1XEVD0|:RL1XEVD0:SPECTrum:OBWidth?

Arguments None

Returns #<Num_digit><Num_byte><Data(1)><Data(2)>...<Data(n)>

Where

<Num_digit> is the number of digits in <Num_byte>.

<Num_byte> is the number of bytes of the data that follow.

<Data(n)> is the spectrum amplitude in dBm.

Four-byte little endian floating-point format specified IEEE 488.2.

n: Max 240001

Invalid data is returned as -1000.

Measurement Modes DEMFL1XEVD0, DEMRL1XEVD0

Examples :READ:FL1XEVD0:SPECTrum:OBWidth?
might return #510240xxx... (10240-byte data) as the spectrum waveform data of the occupied bandwidth measurement under the 1xEV-DO forward link standard.

Related Commands :INSTRument[:SElect]

:READ:FL1XEVD0:TAMPlitude:PVTime? (Query Only)

Obtains the time domain amplitude data of the gated output power measurement under the 1xEV-DO forward link standard.

Syntax :READ:FL1XEVD0:TAMPlitude:PVTime?

Arguments None

Returns #<Num_digit><Num_byte><Data(1)><Data(2)>...<Data(n)>

Where

<Num_digit> is the number of digits in <Num_byte>.

<Num_byte> is the number of bytes of the data that follow.

<Data(n)> is the absolute power for each symbol in dBm.

Four-byte little endian floating-point format specified IEEE 488.2.

n: Max 512000 (= 1024 points × 500 frames)

Invalid data is returned as -1000.

Measurement Modes DEMFL1XEVD0

Examples :READ:FL1XEVD0:TAMPlitude:PVTime?
might return #510240xxx... (10240-byte data) as the results of the gated output power measurement under the 1xEV-DO forward link standard.

Related Commands :INSTrument[:SElect]

:READ:SADLR5_3GPP|:SAULR5_3GPP Subgroup

3GPP-R5 Analysis, Option 27 Only

The :READ:SADLR5_3GPP|:SAULR5_3GPP commands return the results of spectrum analysis for 3GPP-R5 downlink or uplink.

Command Tree	Header	Parameter
	:READ	
	:SADLR5_3GPP :SAULR5_3GPP	
		:ACLR?
		:CFrequency?
		:CHPower?
		:EBWidth?
		:MCAClr?
		:OBWidth?
		:SEMask?
		:SPECTrum?
		:ACLR?
		:CFrequency?
		:CHPower?
		:EBWidth?
		:MCAClr?
		:OBWidth?
		:SEMask?

:READ:SADLR5_3GPP|:SAULR5_3GPP:ACLR? (Query Only)

Returns the results of the ACLR (Adjacent Channel Leakage Power Ratio) measurement in the 3GPP-R5 analysis.

Syntax :READ:SADLR5_3GPP|:SAULR5_3GPP:ACLR?

Arguments None

Returns <Pass_Fail><Chpower>,<Lac1r1>,<Uac1r1>,<Lac1r2>,<Uac1r2>

Where

<Pass_Fail>::={ 1 | -1 | 0 } is the limit test result.

1: Pass, -1: Fail, 0: No decision (measurement limits disabled).

<Chpower>::=<NRf> is the channel power measured value in dBm.

<Lac1r1>::=<NRf> is the 1st lower adjacent channel ACLR in dBc.

<Uac1r1>::=<NRf> is the 1st upper adjacent channel ACLR in dBc.

<Lac1r2>::=<NRf> is the 2nd lower adjacent channel ACLR in dBc.

<Uac1r2>::=<NRf> is the 2nd upper adjacent channel ACLR in dBc.

Invalid data is returned as -1000.

Measurement Modes SADLR5_3G, SAULR5_3G

Examples :READ:SADLR5_3GPP:ACLR?
might return 1,-18.17,59.35,56.83,57.88,58.52 for the ACLR measurement results.

Related Commands :INSTrument[:SElect]

:READ:SADLR5_3GPP|:SAULR5_3GPP:CFrequency? (Query Only)

Returns the results of the carrier frequency measurement in the 3GPP-R5 analysis.

Syntax :READ:SADLR5_3GPP|:SAULR5_3GPP:CFrequency?

Arguments None

Returns <Cfreq>::=<NRf> is the carrier frequency measured value in Hz.

Measurement Modes SADLR5_3G, SAULR5_3G

Examples :READ:SADLR5_3GPP:CFrequency?
might return 2.025E+9, indicating that the carrier frequency is 2.025 GHz.

Related Commands :INSTrument[:SElect]

:READ:SADLR5_3GPP|:SAULR5_3GPP:CHPower? (Query Only)

Returns the results of the channel power measurement in the 3GPP-R5 analysis.

Syntax :READ:SADLR5_3GPP|:SAULR5_3GPP:CHPower?

Arguments None

Returns <pass_fail>,<chpower>,<power_density>

Where

<pass_fail>::={ 1 | 0 } is the measurement result; 1: Pass or 0: Fail.

<chpower>::=<NRf> is the channel power measured value in dBm.

<power_density>::=<NRf> is the power density measured value in dBm/Hz.

<pass_fail> returns 1 (one) when the test is disabled.

Measurement Modes SADLR5_3G, SAULR5_3G

Examples :READ:SADLR5_3GPP:CHPower?
might return 1,-2.0375E+001,-8.1274E+001 for the channel power measurement.

Related Commands :INSTrument[:SElect]

:READ:SADLR5_3GPP|:SAULR5_3GPP:EBWidth? (Query Only)

Returns the results of the EBW (Emission Bandwidth) measurement in the 3GPP-R5 analysis.

Syntax :READ:SADLR5_3GPP|:SAULR5_3GPP:EBWidth?

Arguments None

Returns <ebw>::=<NRf> is the EBW in Hz.

Measurement Modes SADLR5_3G, SAULR5_3G

Examples :READ:SADLR5_3GPP:EBWidth?
might return 3.843E+6, indicating that the EBW is 3.843 MHz.

Related Commands :INSTRument[:SElect]

:READ:SADLR5_3GPP:MCAClr? (Query Only)

Returns the results of the multi-carrier ACLR (Adjacent Channel Leakage Power Ratio) measurement in the 3GPP-R5 downlink analysis.

Syntax :READ:SADLR5_3GPP:MCAClr?

Arguments None

Returns <Pass_Fail>,<Mainchannel_No>,<Totalpower>,
<Chpower1>,<Chpower2>,<Chpower3>,<Chpower4>,
<Lac1r1>,<Uac1r1>,<Lac1r2>,<Uac1r2>

Where

<Pass_Fail>::={ 1 | -1 | 0 } is the limit test result.

1: Pass, -1: Fail, 0: No decision (measurement limits disabled).

<Mainchannel_No>::=<NR1> is the number of main channels (1 to 4).

<Totalpower>::=<NRf> is the total power measured value in dBm.

<Chpower1>::=<NRf> is the power measured value for Channel 1 in dBm.

<Chpower2>::=<NRf> is the power measured value for Channel 2 in dBm.

<Chpower3>::=<NRf> is the power measured value for Channel 3 in dBm.

<Chpower4>::=<NRf> is the power measured value for Channel 4 in dBm.

<Lac1r1>::=<NRf> is the first lower adjacent channel ACLR in dBc.

<Uac1r1>::=<NRf> is the first upper adjacent channel ACLR in dBc.

<Lac1r2>::=<NRf> is the second lower adjacent channel ACLR in dBc.

<Uac1r2>::=<NRf> is the second upper adjacent channel ACLR in dBc.

Invalid data is returned as -1000.

Measurement Modes SADLR5_3G

Examples :READ:SADLR5_3GPP:MCAClr?
might return 1,4,-12.18,-18.14,-18.04,-18.16,-18.17,59.35,56.83,
57.88,58.52 for the multi-carrier ACLR measurement results.

Related Commands :INSTrument[:SELEct]

:READ:SADLR5_3GPP|:SAULR5_3GPP:OBWidth? (Query Only)

Returns the results of the OBW (Occupied Bandwidth) measurement in the 3GPP-R5 analysis.

Syntax :READ:SADLR5_3GPP|:SAULR5_3GPP:OBWidth?

Arguments None

Returns <pass_fail>,<obw>

Where

<pass_fail>::={ 1 | 0 } is the measurement result; 1: Pass or 0: Fail.

<obw>::=<NRf> is the occupied bandwidth in Hz.

<pass_fail> returns 1 (one) when the test is disabled.

Measurement Modes SADLR5_3G, SAULR5_3G

Examples :READ:SADLR5_3GPP:OBWidth?
might return 1,1.27333E+006 for the OBW measurement.

Related Commands :INSTrument[:SElect]

:READ:SADLR5_3GPP|:SAULR5_3GPP:SEMask? (Query Only)

Returns the results of the spectrum emission mask measurement in the 3GPP-R5 analysis.

Syntax :READ:SADLR5_3GPP|:SAULR5_3GPP:SEMask?

Arguments None

Returns <pass_fail>::={ 1 | 0 } is the measurement result; 1: Pass or 0: Fail.

Measurement Modes SADLR5_3G, SAULR5_3G

Examples :READ:SADLR5_3GPP:SEMask?
might return 1 for the spectrum emission mask measurement.

Related Commands :INSTrument[:SElect]

:READ:SADLR5_3GPP|:SAULR5_3GPP:SPECTrum:ACLR? (Query Only)

Returns the results of the ACLR (Adjacent Channel Leakage Power Ratio) measurement in the 3GPP-R5 analysis.

Syntax :READ:SADLR5_3GPP|:SAULR5_3GPP:ACLR?

Arguments None

Returns <Pass_Fail><Chpower>,<Lac1r1>,<Uac1r1>,<Lac1r2>,<Uac1r2>

Where

<Pass_Fail>::={ 1 | 0 } is the measurement result; 1: Pass or 0: Fail.

<Chpower>::=<NRf> is the power measured value for Channel 1 in dBm.

<Lac1r1>::=<NRf> is the 1st lower adjacent channel ACLR in dBc.

<Uac1r1>::=<NRf> is the 1st upper adjacent channel ACLR in dBc.

<Lac1r2>::=<NRf> is the 2nd lower adjacent channel ACLR in dBc.

<Uac1r2>::=<NRf> is the 2nd upper adjacent channel ACLR in dBc.

<Pass_Fail> returns 1 (one) when the test is disabled.

Invalid data is returned as -1000.

Measurement Modes SADLR5_3G, SAULR5_3G

Examples :READ:SADLR5_3GPP:ACLR?
might return 1,-18.17,59.35,56.83,57.88,58.52 for the downlink ACLR measurement results.

Related Commands :INSTrument[:SElect]

:READ:SADLR5_3GPP|:SAULR5_3GPP:SPECTrum:CFRequency? (Query Only)

Returns the spectrum waveform data of the carrier frequency measurement in the 3GPP-R5 analysis.

Syntax :READ:SADLR5_3GPP|:SAULR5_3GPP:SPECTrum:CFRequency?

Arguments None

Returns #<Num_digit><Num_byte><Data(1)><Data(2)>...<Data(n)>

Where

<Num_digit> is the number of digits in <Num_byte>.

<Num_byte> is the number of bytes of data that follow.

<Data(n)> is the spectrum amplitude in dBm.

Four-byte little endian floating-point format specified in IEEE 488.2.

n: Max 240001

Invalid data is returned as -1000.

Measurement Modes SADLR5_3G, SAULR5_3G

Examples :READ:SADLR5_3GPP:SPECTrum:CFRequency?
might return #510240xxx... (10240-byte data) as the spectrum waveform data of the carrier frequency measurement.

Related Commands :INSTrument[:SElect]

:READ:SADLR5_3GPP|:SAULR5_3GPP:SPECTrum:CHPower? (Query Only)

Returns the spectrum waveform data of the channel power measurement in the 3GPP-R5 analysis.

Syntax :READ:SADLR5_3GPP|:SAULR5_3GPP:SPECTrum:CHPower?

Arguments None

Returns #<Num_digit><Num_byte><Data(1)><Data(2)>...<Data(n)>

Where

<Num_digit> is the number of digits in <Num_byte>.

<Num_byte> is the number of bytes of data that follow.

<Data(n)> is the spectrum amplitude in dBm.

Four-byte little endian floating-point format specified in IEEE 488.2.

n: Max 240001

Invalid data is returned as -1000.

Measurement Modes SADLR5_3G, SAULR5_3G

Examples :READ:SADLR5_3GPP:SPECTrum:CHPower?
might return #510240xxx... (10240-byte data) as the spectrum waveform data of the channel power measurement.

Related Commands :INSTRument[:SElect]

:READ:SADLR5_3GPP|SAULR5_3GPP:SPECTrum:EBWidth? (Query Only)

Returns the spectrum waveform data of the EBW (Emission Bandwidth) measurement in the 3GPP-R5 analysis.

Syntax :READ:SADLR5_3GPP|SAULR5_3GPP:SPECTrum:EBWidth?

Arguments None

Returns #<Num_digit><Num_byte><Data(1)><Data(2)>...<Data(n)>

Where

<Num_digit> is the number of digits in <Num_byte>.

<Num_byte> is the number of bytes of data that follow.

<Data(n)> is the spectrum amplitude in dBm.

Four-byte little endian floating-point format specified in IEEE 488.2.

n: Max 240001

Invalid data is returned as -1000.

Measurement Modes SADLR5_3G, SAULR5_3G

Examples :READ:SADLR5_3GPP:SPECTrum:EBWidth?
might return #510240xxx... (10240-byte data) as the spectrum waveform data of the EBW measurement.

Related Commands :INSTrument[:SElect]

:READ:SADLR5_3GPP:SPECTrum:MCAClr? (Query Only)

Returns the spectrum waveform data of the multi-carrier ACLR (Adjacent Channel Leakage Power Ratio) measurement in the 3GPP-R5 downlink analysis.

Syntax :READ:SADLR5_3GPP:SPECTrum:MCAClr?

Arguments None

Returns #<Num_digit><Num_byte><Data(1)><Data(2)>...<Data(n)>

Where

<Num_digit> is the number of digits in <Num_byte>.

<Num_byte> is the number of bytes of data that follow.

<Data(n)> is the spectrum amplitude in dBm.

Four-byte little endian floating-point format specified in IEEE 488.2.

n: Max 240001

Invalid data is returned as -1000.

Measurement Modes SADLR5_3G

Examples :READ:SADLR5_3GPP:SPECTrum:MCAClr?
might return #510240xxx... (10240-byte data) as the spectrum waveform data of the multi-carrier ACLR measurement.

Related Commands :INSTRument[:SElect]

:READ:SADLR5_3GPP|SAULR5_3GPP:SPECTrum:OBWidth? (Query Only)

Returns the spectrum waveform data of the OBW (Occupied Bandwidth) measurement in the 3GPP-R5 analysis.

Syntax :READ:SADLR5_3GPP|SAULR5_3GPP:SPECTrum:OBWidth?

Arguments None

Returns #<Num_digit><Num_byte><Data(1)><Data(2)>...<Data(n)>

Where

<Num_digit> is the number of digits in <Num_byte>.

<Num_byte> is the number of bytes of data that follow.

<Data(n)> is the spectrum amplitude in dBm.

Four-byte little endian floating-point format specified in IEEE 488.2.

n: Max 240001

Invalid data is returned as -1000.

Measurement Modes SADLR5_3G, SAULR5_3G

Examples :READ:SADLR5_3GPP:SPECTrum:OBWidth?
might return #510240xxx... (10240-byte data) as the spectrum waveform data of the OBW measurement.

Related Commands :INSTrument[:SElect]

:READ:SADLR5_3GPP|:SAULR5_3GPP:SPECTrum:SEMAsk? (Query Only)

Returns the spectrum waveform data of the spectrum emission mask measurement in the 3GPP-R5 analysis.

Syntax :READ:SADLR5_3GPP|:SAULR5_3GPP:SPECTrum:SEMAsk?

Arguments None

Returns #<Num_digit><Num_byte><Data(1)><Data(2)>...<Data(n)>

Where

<Num_digit> is the number of digits in <Num_byte>.

<Num_byte> is the number of bytes of data that follow.

<Data(n)> is the spectrum amplitude in dBm.

Four-byte little endian floating-point format specified in IEEE 488.2.

n: Max 240001

Invalid data is returned as -1000.

Measurement Modes SADLR5_3G, SAULR5_3G

Examples :READ:SADLR5_3GPP:SPECTrum:SEMAsk?
might return #510240xxx... (10240-byte data) as the spectrum waveform data of the spectrum emission mask measurement.

Related Commands :INSTRument[:SELect]

:READ:TD_SCDMA Subgroup***TD-SCDMA Analysis, Option 28 Only***

The :READ:TD_SCDMA commands return the results of the TD-SCDMA analysis.

Command Tree	Header	Parameter
	:READ	
	:TD_SCDMA	
	:ACLR?	
	:CHPower?	
	:IM?	
	:OBWidth?	
	:SEMask?	
	:SPECTrum	
	:ACLR?	
	:CHPower?	
	:IM?	
	:OBWidth?	
	:SEMask?	

NOTE. There are no :READ subsystem for :CDPower?, :MACCuracy?, STABLE?, :SFSUMarry?, :TAMplitude:TSSummary?, and :TAMplitude:SFSummary? commands. To retrieve the measurement results, execute the [:SENSe]:TD_SCDMA[:IMMEDIATE] command.

:READ:TD_SCDMA:ACLR? (Query Only)

Obtains the results of the adjacent channel leakage power ratio measurement under the TD-SCDMA standard.

Syntax :READ:TD_SCDMA:ACLR?

Arguments None

Returns <Pass_fail>,<Chpower>, or
<Pass_fail>,<Chpower>,<L_Acpr1>,<U_Acpr1>, or
<Pass_fail>,<Chpower>,<L_Acpr1>,<U_Acpr1>,<L_Acpr2>,<U_Acpr2>

Where

<Pass_fail>::={ 1 | 0 } is the measurement result; 1: Pass or 0: Fail.

<Chpower>::=<NRf> is the channel power measured value in dBm.

<L_Acpr1>::=<NRf> is the first lower adjacent channel ACPR in dBc.

<U_Acpr1>::=<NRf> is the first upper adjacent channel ACPR in dBc.

<L_Acpr2>::=<NRf> is the second lower adjacent channel ACPR in dBc.

<U_Acpr2>::=<NRf> is the second upper adjacent channel ACPR in dBc.

Measurement Modes DEMTD_SCDMA

Example :READ:TD_SCDMA:ACLR?
might return 0,--2.045E+001,--6.461E+001,--4.379E+001,--6.576E+001,
--6.753E+001 for the ACLR measurement under the TD-SCDMA standard.

Related Commands :INSTrument[:SElect]

:READ:TD_SCDMA:CHPower? (Query Only)

Obtains the results of the channel power measurement under the TD-SCDMA standard.

Syntax :READ:TD_SCDMA:CHPower?

Arguments None

Returns <Pass_fail>,<chpower>,<power_density>

Where

<Pass_fail>::={ 1 | 0 } is the measurement result; 1: Pass or 0: Fail.

<Chpower>::=<NRf> is the channel power measured value in dBm.

<Power_density>::=<NRf> is the power density measured value in dBm/Hz.

Measurement Modes DEMTD_SCDMA

Example :READ:TD_SCDMA:CHPower?
might return 1,--2.0339E+001,--8.1238E+001 for the channel power measurement under the TD-SCDMA standard.

Related Commands :INSTrument[:SElect]

:READ:TD_SCDMA:IM? (Query Only)

Obtains the results of the intermodulation measurement under the TD-SCDMA standard.

Syntax :READ:TD_SCDMA:IM?

Arguments None

Returns <Pass_fail>,<L_channel>,<U_channel>,<L3_lower>,<L3_upper>,<U3_lower>,<U3_upper>,<L5_lower>,<L5_upper>,<U5_lower>,<U5_upper>

Where

<Pass_fail>::={ 1 | 0 } is the measurement result; 1: Pass or 0: Fail.

<L_channel>::=<NRf> is the lower channel measured value in dBm.

<U_channel>::=<NRf> is the upper channel measured value in dBm.

<L3_lower>::=<NRf> is the lower third order (lower) measured value in dBc.

<L3_upper>::=<NRf> is the lower third order (upper) measured value in dBc.

<U3_lower>::=<NRf> is the upper third order (lower) measured value in dBc.

<U3_upper>::=<NRf> is the upper third order (upper) measured value in dBc.

<L5_lower>::=<NRf> is the lower fifth order (lower) measured value in dBc.

<L5_upper>::=<NRf> is the lower fifth order (upper) measured value in dBc.

<U5_lower>::=<NRf> is the upper fifth order (lower) measured value in dBc.

<U5_upper>::=<NRf> is the upper fifth order (upper) measured value in dBc.

When each value is not present, the value of -1000 is returned.

Measurement Modes DEMTD_SCDMA

Example :READ:TD_SCDMA:IM?
might return 1,--2.061E+001,--5.501E+001,--1.66E+001,1.78E+001,
--4.76E+001,--1.32E+001,--4.73E+001,--1.29E+001,--5.1E+001,
--1.66E+001 for the intermodulation measurement under the TD-SCDMA
standard.

Related Commands :INSTrument[:SELect]

:READ:TD_SCDMA:OBWidth? (Query Only)

Obtains the results of the occupied bandwidth measurement under the TD-SCDMA standard.

Syntax :READ:TD_SCDMA:OBWidth?

Arguments None

Returns <Pass_fail>,<obw>

Where

<Pass_fail>::={ 1 | 0 } is the measurement result; 1: Pass or 0: Fail.

<obw>::=<NRf> is the occupied bandwidth in Hz.

Measurement Modes DEMTD_SCDMA

Example :READ:TD_SCDMA:OBWidth?
might return 1,1.27333E+006 for the OBW measurement under the TD-SCDMA standard.

Related Commands :INSTrument[:SElect]

:READ:TD_SCDMA:SEMask? (Query Only)

Obtains the results of the spectrum emission mask measurement under the TD-SCDMA standard.

Syntax :READ:TD_SCDMA:SEMask?

Arguments None

Returns <Pass_fail>

Where
<Pass_fail>::={ 1 | 0 } is the measurement result; 1: Pass or 0: Fail.

Measurement Modes DEMTD_SCDMA

Example :READ:TD_SCDMA:SEMask?
might return 1, indicating that the spectrum emission mask measurement has passed.

Related Commands :INSTrument[:SElect]

:READ:TD_SCDMA:SPECTrum:ACLR? (Query Only)

Obtains the results of the adjacent channel leakage power ratio measurement under the TD-SCDMA standard.

Syntax :READ:TD_SCDMA:SPECTrum:ACLR?

Arguments None

Returns #<Num_digit><Num_byte><Data(1)><Data(2)>...<Data(n)>

Where

<Num_digit> is the number of digits in <Num_byte>.

<Num_byte> is the number of bytes of the data that follow.

<Data(n)> is the spectrum amplitude in dBm.

Four-byte little endian floating-point format specified IEEE 488.2.

n: Max 240001

Measurement Modes DEMTD_SCDMA

Example :READ:TD_SCDMA:SPECTrum:ACLR?
might return #510240xxx... (10240-bytes of floating point data) as the spectrum waveform data of the ACLR measurement under the TD-SCDMA standard.

Related Commands :INSTrument[:SElect]

:READ:TD_SCDMA:SPECTrum:CHPower? (Query Only)

Obtains the spectrum waveform data of the channel power measurement under the TD-SCDMA standard.

Syntax :READ:TD_SCDMA:SPECTrum:CHPower?

Arguments None

Returns #<Num_digit><Num_byte><Data(1)><Data(2)>...<Data(n)>

Where

<Num_digit> is the number of digits in <Num_byte>.

<Num_byte> is the number of bytes of the data that follow.

<Data(n)> is the spectrum amplitude in dBm.

Four-byte little endian floating-point format specified IEEE 488.2.

n: Max 240001

Measurement Modes DEMTD_SCDMA

Example :READ:TD_SCDMA:SPECTrum:CHPower?
might return #510240xxx... (10240-bytes of floating point data) as the spectrum waveform data of the channel power measurement under the TD-SCDMA standard.

Related Commands :INSTrument[:SElect]

:READ:TD_SCDMA:SPECTrum:IM? (Query Only)

Obtains the spectrum waveform data of the intermodulation measurement under the TD-SCDMA standard.

Syntax :READ:TD_SCDMA:SPECTrum:IM?

Arguments None

Returns #<Num_digit><Num_byte><Data(1)><Data(2)>...<Data(n)>

Where

<Num_digit> is the number of digits in <Num_byte>.

<Num_byte> is the number of bytes of the data that follow.

<Data(n)> is the spectrum amplitude in dBm.

Four-byte little endian floating-point format specified IEEE 488.2.

n: Max 240001.

Invalid data is returned as -1000.

Measurement Modes DEMTD_SCDMA

Example :READ:TD_SCDMA:SPECTrum:IM?
might return #510240xxx... (10240-bytes of floating point data) as the spectrum waveform data of the intermodulation measurement under the TD-SCDMA standard.

Related Commands :INSTrument[:SElect]

:READ:TD_SCDMA:SPECTrum:OBWidth? (Query Only)

Obtains the spectrum waveform data of the occupied bandwidth measurement under the TD-SCDMA standard.

Syntax :READ:TD_SCDMA:SPECTrum:OBWidth?

Arguments None

Returns #<Num_digit><Num_byte><Data(1)><Data(2)>...<Data(n)>

Where

<Num_digit> is the number of digits in <Num_byte>.

<Num_byte> is the number of bytes of the data that follow.

<Data(n)> is the spectrum amplitude in dBm.

Four-byte little endian floating-point format specified IEEE 488.2.

n: Max 240001

Invalid data is returned as -1000.

Measurement Modes DEMTD_SCDMA

Example :READ:TD_SCDMA:SPECTrum:OBWidth?
might return #510240xxx... (10240-bytes of floating point data) as the spectrum waveform data of the occupied bandwidth measurement under the TD-SCDMA standard.

Related Commands :INSTrument[:SElect]

:READ:TD_SCDMA:SPECTrum:SEMask? (Query Only)

Obtains the spectrum waveform data of the spectrum emission mask measurement under the TD-SCDMA standard.

Syntax :READ:TD_SCDMA:SPECTrum:SEMask?

Arguments None

Returns #<Num_digit><Num_byte><Data(1)><Data(2)>...<Data(n)>

Where

<Num_digit> is the number of digits in <Num_byte>.

<Num_byte> is the number of bytes of the data that follow.

<Data(n)> is the spectrum amplitude in dBm.

Four-byte little endian floating-point format specified IEEE 488.2.

n: Max 240001

Invalid data is returned as -1000.

Measurement Modes DEMTD_SCDMA

Example :READ:TD_SCDMA:SPECTrum:SEMask?
might return #510240xxx... (10240-bytes of floating point data) as the spectrum waveform data of the spectrum emissions mask measurement under the TD-SCDMA standard.

Related Commands :INSTrument[:SElect]

:READ:SWLAN Subgroup

WLAN Analysis, Option 29 Only

The :READ:SWLAN commands return the results of the IEEE802.11n (nx1) analysis.

Command Tree	Header	Parameter
	:READ	
	:SWLAN	
	:SMASK?	
	:SPECTrum	
	:SMASK?	

NOTE. For the :READ:SWLAN commands, execute the [:SENSe]:SWLAN [:IMMEDIATE] command to retrieve the measurement results.

:READ:SWLAN:SMASK? (Query Only)

Returns the result of the spectrum mask measurement in the 802.11n (nx1) analysis.

Syntax :READ:SWLAN:SMASK?

Arguments None

Returns <pass_fail>::={ 1 | 0 } is the measurement result; 1: Pass or 0: Fail.
<pass_fail> returns 1 (one) when the test is disabled.

Measurement Modes DEMSWLAN

Examples :READ:SWLAN:SMASK?
might return 1, indicating that the test has passed.

Related Commands :INSTRument[:SElect]

:READ:SWLAN:SPECTrum:SMASK? (Query Only)

Returns spectrum waveform data of the spectrum mask measurement in the 802.11n (nx1) analysis.

Syntax :READ:SWLAN:SPECTrum:SMASK?

Arguments None

Returns #<Num_digit><Num_byte><Data(1)><Data(2)>...<Data(n)>

Where

<Num_digit> is the number of digits in <Num_byte>.

<Num_byte> is the number of bytes of data that follow.

<Data(n)> is the amplitude spectrum in dBm.

4-byte little endian floating-point format specified in IEEE 488.2.

n: Max 240001

Measurement Modes DEMSWLAN

Examples :READ:SWLAN:SPECTrum:SMASK?
might return #43200xxxx... (3200-byte data) for the spectrum waveform data.

Related Commands :INSTrument[:SElect]

:READ:WLAN Subgroup

WLAN Analysis, Option 29 Only

The :READ:WLAN commands return the results of the IEEE802.11a/b/g analysis.

Command Tree	Header	Parameter
	:READ	
	:WLAN	
	:POWer	
	:TPOWer?	POSitive NEGative
	:SMASk?	
	:SPECTrum	
	:SMASk?	
	:TPOWer?	

NOTE. For the :READ:WLAN commands, execute the [:SENSe]:WLAN [:IMMediate] command to retrieve the measurement results.

:READ:WLAN:POWer:TPOWer? (Query Only)

Returns spectrum waveform data of the transmit power measurement in the IEEE802.11a/b/g analysis.

Syntax :READ:WLAN:POWer:TPOWer? { POSitive | NEGative }

Arguments POSitive specifies the power-on ramp.
NEGative specifies the power-down ramp.

Returns #<Num_digit><Num_byte><Data(1)><Data(2)>...<Data(n)>

Where

<Num_digit> is the number of digits in <Num_byte>.

<Num_byte> is the number of bytes of the data that follow.

<Data(n)> is the power spectrum in watts.

4-byte little endian floating-point format specified IEEE 488.2.

n: Max 512000 (= 1024 points × 500 frames)

Measurement Modes DEMWLAN

Examples :READ:WLAN:POWer:TPOWer? POSitive
might return #43200xxxx... (3200-byte data) for the spectrum waveform data of the power-on ramp.

Related Commands :INSTrument[:SELect]

:READ:WLAN:SMASK? (Query Only)

Returns the result of the spectrum mask measurement in the IEEE802.11a/b/g analysis.

Syntax :READ:WLAN:SMASK?

Arguments None

Returns <pass_fail>::={ 1 | 0 } is the measurement result; 1: Pass or 0: Fail.
<pass_fail> returns 1 (one) when the test is disabled.

Measurement Modes DEMWLAN

Examples :READ:WLAN:SMASK?
might return 1, indicating that the test has passed.

Related Commands :INSTrument[:SELEct]

:READ:WLAN:SPECTrum:SMASk? (Query Only)

Returns spectrum waveform data of the spectrum mask measurement.

Syntax :READ:WLAN:SPECTrum:SMASk?

Arguments None

Returns #<Num_digit><Num_byte><Data(1)><Data(2)>...<Data(n)>

Where

<Num_digit> is the number of digits in <Num_byte>.

<Num_byte> is the number of bytes of the data that follow.

<Data(n)> is the amplitude spectrum in dBm.

4-byte little endian floating-point format specified IEEE 488.2.

n: Max 240001

Measurement Modes DEMWLAN

Examples :READ:WLAN:SPECTrum:SMASk?
might return #43200xxxx... (3200-byte data) for the spectrum waveform data.

Related Commands :INSTrument[:SElect]

:READ:WLAN:TPOWer? (Query Only)

Returns the result of the transmit power measurement in the IEEE802.11a/b/g analysis.

Syntax :READ:WLAN:TPOWer?

Arguments None

Arguments None

Returns <Power_On>,<Power_Off>

Where

<Power_On>::=<NRf> is the power-on time in seconds.

<Power_Off>::=<NRf> is the power-down time in seconds.

Measurement Modes DEMWLAN

Examples :READ:WLAN:TPOWer?
might return 1.352039E-6,1.695838E-6 for the transmit power measurement result.

Related Commands :INSTrument[:SElect]

:SENSe Commands

The :SENSe commands set the details for each of the measurement sessions. They are divided into the following subgroups:

Table 2-91: :SENSe command subgroups

Command header	Function	Refer to:
[:SENSE]:ACPower	Sets up ACPR measurement.	page 2-1036
[:SENSE]:ADEMod	Sets up analog modulation analysis.	page 2-1040
[:SENSE]:AVERage	Sets up average.	page 2-1048
[:SENSE]:BSIZe	Sets the block size.	page 2-1051
[:SENSE]:CCDF	Sets up CCDF measurement.	page 2-1052
[:SENSE]:CFRequency	Sets up carrier frequency measurement.	page 2-1055
[:SENSE]:CHPower	Sets up channel power measurement.	page 2-1056
[:SENSE]:CNRatio	Sets up C/N measurement.	page 2-1059
[:SENSE]:CORRection	Sets up amplitude correction.	page 2-1064
[:SENSE]:EBWidth	Sets up EBW measurement.	page 2-1069
[:SENSE]:FEED	Sets up signal path.	page 2-1071
[:SENSE]:FREQuency	Sets up frequency-related conditions.	page 2-1072
[:SENSE]:OBWidth	Sets up OBW measurement.	page 2-1080
[:SENSE]:PULSe	Sets up pulse characteristics measurement.	page 2-1082
[:SENSE]:ROSCillator	Sets up reference oscillator.	page 2-1092
[:SENSE]:SPECTrum	Sets up spectrum measurement.	page 2-1093
[:SENSE]:SPURious	Sets up spurious signal measurement.	page 2-1111
[:SENSE]:TRANsient	Sets up time domain measurement.	page 2-1115

[[:SENSe]:ACPower Subgroup

The [[:SENSe]:ACPower commands set up the conditions related to the adjacent channel leakage power ratio (ACPR) measurement in the S/A (spectrum analysis) mode.

Command Tree	Header	Parameter
	[SENSe]	
	:ACPower	
	:BANDwidth :BWIDth	
	:ACHannel	<frequency>
	:INTEgration	<frequency>
	:CSPacing	<frequency>
	:FILTer	
	:COEFFicient	<numeric_value>
	:TYPE	RECTangle GAUSSian NYQuist RNYQuist

Prerequisites for Use

To use a command from this group, you must have run at least the following two commands:

1. Run the following command to set the measurement mode to S/A:

```
:INSTrument[:SElect] { SANORMAL | SASGRAM | SARTIME  
| SAUL3G }
```

2. Run one of the following commands to start the ACPR measurement:

- To start the measurement with the default settings:
:CONFIgure:SPECTrum:ACPower
- To start the measurement without modifying the current settings:
[:SENSe]:SPECTrum:MEASurement ACPower

[[:SENSe]:ACPower:BANDwidth]:BWIDth:ACHannel(?)

Sets or queries the bandwidth of the adjacent channels for the ACPR measurement (see Figure 2-18).

Syntax [[:SENSe]:ACPower:BANDwidth]:BWIDth:ACHannel <value>

[[:SENSe]:ACPower:BANDwidth]:BWIDth:ACHannel?

Arguments <value>::=<NRf> specifies the bandwidth of the adjacent channels for the ACPR measurement. Range: (bin bandwidth) × 8 to full span [Hz]. Refer to the *RSA3408A User Manual* for the bin bandwidth.

Measurement Modes SANORMAL, SASGRAM, SARTIME, SAUL3G

Examples :SENSe:ACPower:BANDwidth:ACHannel 3.5MHz
sets the bandwidth of the adjacent channels to 3.5 MHz.

[[:SENSe]:ACPower:BANDwidth]:BWIDth:INTEgration(?)

Sets or queries the bandwidth of the main channel for the ACPR measurement (see Figure 2-18).

Syntax [[:SENSe]:ACPower:BANDwidth]:BWIDth:INTEgration <value>

[[:SENSe]:ACPower:BANDwidth]:BWIDth:INTEgration?

Arguments <value>::=<NRf> specifies the bandwidth of the main channel for the ACPR measurement. Range: (bin bandwidth) × 8 to full span [Hz]. Refer to the *RSA3408A User Manual* for the bin bandwidth.

Measurement Modes SANORMAL, SASGRAM, SARTIME, SAUL3G

Examples :SENSe:ACPower:BANDwidth:INTEgration 3.5MHz
sets the bandwidth of the main channel to 3.5 MHz.

[:SENSe]:ACPower:CSPacing(?)

Sets or queries the channel-to-channel spacing for the ACPR measurement (see Figure 2-18).

Syntax [:SENSe]:ACPower:CSPacing <value>

[:SENSe]:ACPower:CSPacing?

Arguments <value>::=<NRF> specifies the channel-to-channel spacing for the ACPR measurement. Range: (bin bandwidth) × 8 to full span [Hz]. Refer to the *RSA3408A User Manual* for the bin bandwidth.

Measurement Modes SANORMAL, SASGRAM, SARTIME, SAUL3G

Examples :SENSe:ACPower:CSPacing 5MHz
sets the channel-to-channel spacing to 5 MHz.

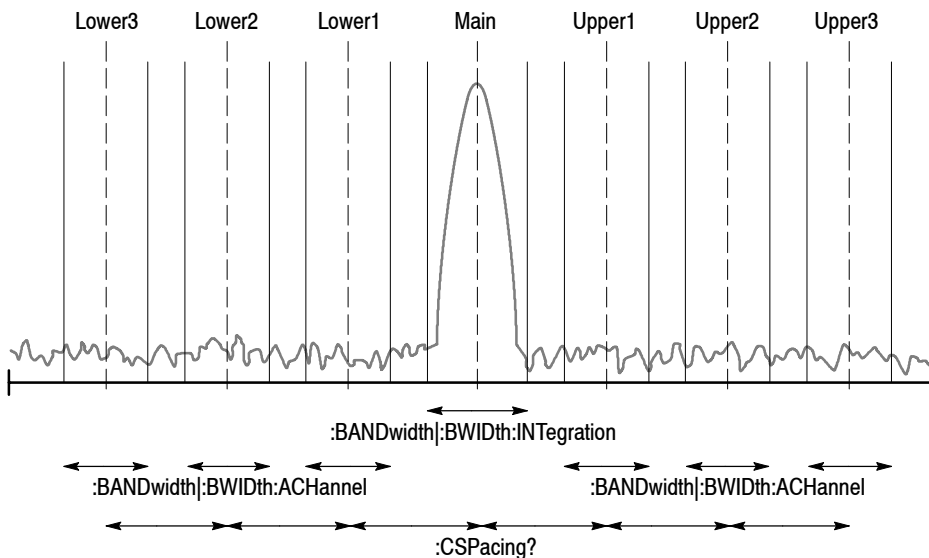

NOTE: The command header [:SENSe]:ACPower is omitted here.

Figure 2- 18: Setting up the ACPR measurement

[:SENSe]:ACPower:FILTer:COEFFicient(?)

Sets or queries the filter roll-off rate for the ACPR measurement when you have selected either NYQuist (Nyquist filter) or RNYQuist (Root Nyquist filter) using the [:SENSe]:ACPower:FILTer:TYPE command.

Syntax [:SENSe]:ACPower:FILTer:COEFFicient <ratio>
[:SENSe]:ACPower:FILTer:COEFFicient?

Arguments <ratio>::=<NRf> specifies the roll-off rate. Range: 0 to 1.

Measurement Modes SANORMAL, SASGRAM, SARTIME, SAUL3G

Examples :SENSe:ACPower:FILTer:COEFFicient 0.5
sets the filter roll-off rate to 0.5.

Related Commands [:SENSe]:ACPower:FILTer:TYPE

[:SENSe]:ACPower:FILTer:TYPE(?)

Selects or queries the filter for the ACPR measurement.

Syntax [:SENSe]:ACPower:FILTer:TYPE { RECTangle | GAUSSian | NYQuist
| RNYQuist }
[:SENSe]:ACPower:FILTer:TYPE?

Arguments RECTangle selects the rectangular filter.
GAUSSian selects the Gaussian filter.
NYQuist selects the Nyquist filter (default).
RNYQuist selects the Root Nyquist filter.

Measurement Modes SANORMAL, SASGRAM, SARTIME, SAUL3G

Examples :SENSe:ACPower:FILTer:TYPE NYQuist
selects the Nyquist filter for the ACPR measurement.

[:SENSe]:ADEMod Subgroup

Sets up the analog modulation analysis.

NOTE. To use a command from this group, you must have selected *DEMADEM* (analog modulation analysis) in the *:INSTrument[:SElect]* command.

Command Tree	Header	Parameter
	[:SENSe]	
	:ADEMod	
	:AM	
	:CADetection	AVERAge MEDian
	:BLOCK	<numeric_value>
	:CARRier	
	:OFFSet	<numeric_value>
	:SEARch	<boolean>
	:FM	
	:THReshold	<numeric_value>
	[:IMMediate]	
	:LENGth	<numeric_value>
	:MODulation	AM FM PM IQVT OFF
	:OFFSet	<numeric_value>
	:PM	
	:THReshold	<numeric_value>

For the commands defining the analysis range, see the figure below. The analysis range is shown by a green line in the overview.

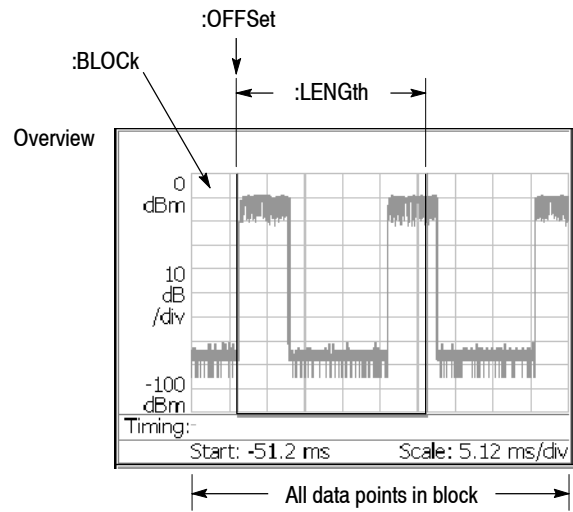

NOTE: Command header [:SENSe]:ADEMod is omitted here.

Figure 2-19: Defining the analysis range

[[:SENSe]:ADEMod:AM:CADetection(?)

Selects or queries the carrier amplitude detection method used to determine the 0% reference modulation.

Syntax [:SENSe]:ADEMod:AM:CADetection { AVERAge | MEDian }
[:SENSe]:ADEMod:AM:CADetection?

Arguments AVERAge defines the 0% reference modulation as the average amplitude in the analysis range (default).
MEDian defines the 0% reference modulation as the median amplitude $((\text{maximum})+(\text{minimum}))/2$ in the analysis range.

Measurement Modes DEMADEM

Examples :SENSe:ADEMod:CARRier:CADetection AVERAge
defines the 0% modulation as the average amplitude in the analysis range.

[[:SENSe]:ADEMod:BLOCK(?)

Sets or queries the number of the block to measure in the analog modulation analysis (see Figure 2-19).

Syntax [:SENSe]:ADEMod:BLOCK <number>
[:SENSe]:ADEMod:BLOCK?

Arguments <number>::=<NR1> specifies the block number. Zero represents the latest block.
Range: -M to 0 (M: Number of acquired blocks)

Measurement Modes DEMADEM

Examples :SENSe:ADEMod:BLOCK -5
sets the block number to -5.

[:SENSe]:ADEMod:CARRier:OFFSet(?)

Sets or queries the carrier frequency offset in the FM signal analysis.

Syntax [:SENSe]:ADEMod:CARRier:OFFSet <freq>
[:SENSe]:ADEMod:CARRier:OFFSet?

Arguments <freq>: :=<Nrf> is the carrier frequency offset. Range: -30 to +30 MHz

Measurement Modes DEMADEM

Examples :SENSe:ADEMod:CARRier:OFFSet 10MHz
sets the carrier frequency offset to 10 MHz.

Related Commands [:SENSe]:ADEMod:CARRier:SEARch

[:SENSe]:ADEMod:CARRier:SEARch(?)

Determines whether to detect the carrier automatically in the FM signal analysis.

Syntax [:SENSe]:ADEMod:CARRier:SEARch { 0 | 1 | OFF | ON }
[:SENSe]:ADEMod:CARRier:SEARch?

Arguments OFF or 0 specifies that the carrier is not detected automatically.
To set it, use the [:SENSe]:ADEMod:CARRier:OFFSet command.
ON or 1 specifies that the carrier is detected automatically.

Measurement Modes DEMADEM

Examples :SENSe:ADEMod:CARRier:SEARch ON
specifies that the carrier is detected automatically.

Related Commands [:SENSe]:ADEMod:CARRier:OFFSet

[[:SENSe]:ADEMod:FM:THReshold(?)]

Sets or queries the threshold level above which the input signal is determined to be a burst in the FM signal analysis. The burst detected first is used for the measurement.

Syntax [:SENSe]:ADEMod:FM:THReshold <value>
 [:SENSe]:ADEMod:FM:THReshold?

Arguments <value>::=<NRf> specifies the threshold level. Range: -100.0 to 0.0 dB.

Measurement Modes DEMADEM

Examples :SENSe:ADEMod:FM:THReshold -10
 sets the threshold level to -10 dB.

[[:SENSe]:ADEMod[:IMMediate] (No Query Form)]

Runs the analog demodulation calculation for the acquired data. To select the analog demodulation method, use the [:SENSe]:ADEMod:MODulation command. To acquire data, use the :INITiate command.

Syntax [:SENSe]:ADEMod[:IMMediate]

Arguments None

Measurement Modes DEMADEM

Examples :SENSe:ADEMod:IMMediate
 runs the analog demodulation calculation.

Related Commands :INITiate, [:SENSe]:ADEMod:MODulation

[:SENSe]:ADEMod:LENGth(?)

Sets or queries the range for the analog modulation analysis (see Figure 2-19 on page 2-1041).

Syntax [:SENSe]:ADEMod:LENGth <value>

 [:SENSe]:ADEMod:LENGth?

Arguments <value>::=<NR1> specifies the analysis range by the number of data points.
Range: 1 to 1024 × Block size (Block size ≤ 500).

To set the block size, use the [:SENSe]:BSIZE command.

Measurement Modes DEMADEM

Examples :SENSe:ADEMod:LENGth 1000
 sets the analysis range to 1000 points.

Related Commands [:SENSe]:BSIZE

[[:SENSe]:ADEMod:MODulation(?)

Selects or queries the measurement item of the analog modulation analysis.

Syntax [:SENSe]:ADEMod:MODulation { AM | FM | PM | IQVT | OFF }
[:SENSe]:ADEMod:MODulation?

Arguments The arguments and measurement items are listed below:

Table 2-92: Measurement item selections

Argument	Measurement item
AM	AM signal analysis
FM	FM signal analysis
PM	PM signal analysis
IQVT	IQ level vs. time measurement
OFF	Turns off the measurement.

Measurement Modes DEMADEM

Examples :SENSe:ADEMod:MODulation PM
selects the PM signal analysis.

[[:SENSe]:ADEMod:OFFSet(?)]

Sets or queries the measurement start position for the analog modulation analysis (see Figure 2-19).

Syntax [[:SENSe]:ADEMod:OFFSet <value>

[[:SENSe]:ADEMod:OFFSet?

Arguments <value>::=<NR1> specifies the measurement start position by the number of points. Range: 0 to $1024 \times (\text{Block size}) - 1$. To set the block size, use the [[:SENSe]:BSIZE command.

Measurement Modes DEMADEM

Examples :SENSe:ADEMod:OFFSet 500
sets the measurement start position to point 500.

Related Commands [[:SENSe]:BSIZE

[[:SENSe]:ADEMod:PM:THReshold(?)]

Sets or queries the threshold level above which the input signal is determined to be a burst in the PM signal analysis. The burst detected first is used for the measurement.

Syntax [[:SENSe]:ADEMod:PM:THReshold <value>

[[:SENSe]:ADEMod:PM:THReshold?

Arguments <value>::=<NRf> specifies the threshold level. Range: -100.0 to 0.0 dB.

Measurement Modes DEMADEM

Examples :SENSe:ADEMod:PM:THReshold -10
sets the threshold level to -10 dB.

[[:SENSe]:AVERage Subgroup

The [[:SENSe]:AVERage commands control averaging process for measured values in the modulation analysis (Demod mode) and the time analysis (Time mode).

NOTE. *Data is always acquired without averaging in the Demod and the Time modes.*

Command Tree	Header	Parameter
	[[:SENSe]	
	:AVERage	
	:CLEar	
	:COUNT	<numeric_value>
	[:STATE]	<boolean>
	:TCONTROL	EXponential REpeat

[:SENSe]:AVERage:CLEar (No Query Form)

Clears average data and counter, and restarts the averaging process.

Syntax [:SENSe]:AVERage:CLEar

Arguments None

Measurement Modes All Demod modes, all Time modes

Examples :SENSe:AVERage:CLEar
clears average data and counter, and restarts the averaging process.

[:SENSe]:AVERage:COUNT(?)

Sets or queries the number of traces to combine using the RMS average. After :COUNT traces have been averaged, the averaging process is controlled by the :TCONtrol setting (refer to page 2-1050).

Syntax [:SENSe]:AVERage:COUNT <value>
[:SENSe]:AVERage:COUNT?

Arguments <value>::=<NR1> is the number of traces to combine for averaging.
Range: 1 to 100000 (default: 20)

Measurement Modes All Demod modes, TIMTRAN

Examples :SENSe:AVERage:COUNT 64
sets the average count to 64.

Related Commands [:SENSe]:AVERage:TCONtrol

[:SENSe]:AVERAge[:STATe](?)

Determines whether to turn averaging on or off.

Syntax [:SENSe]:AVERAge[:STATe] { OFF | ON | 0 | 1 }
 [:SENSe]:AVERAge[:STATe]?

Arguments OFF or 0 turns off averaging.
 ON or 1 turns on averaging.

Measurement Modes All Demod modes, TIMTRAN

Examples :SENSe:AVERAge:STATe ON
 turns on averaging.

[:SENSe]:AVERAge:TCONtrol(?)

Selects or queries the action when more than :AVERAge:COUNT measurement results are generated (TCONtrol is TerminalCONtrol).

Syntax [:SENSe]:AVERAge:TCONtrol { EXPonential | REPeat }
 [:SENSe]:AVERAge:TCONtrol?

Arguments EXPonential continues the RMS (root-mean-square) average with an exponential weighting applied to old values using the setting of [:SENSe]:AVERAge:COUNT as the weighting factor.

 REPeat clears average data and counter, and restarts the averaging process when :AVERAge:COUNT is reached.

Measurement Modes All Demod modes, TIMTRAN

Examples :SENSe:AVERAge:TCONtrol REPeat
 repeats the averaging process.

Related Commands [:SENSe]:AVERAge:COUNT, [:SENSe]:AVERAge:TYPE

[:SENSe]:BSIZE Subgroup

The [:SENSe]:BSIZE command controls the block size (the number of frames in each contiguous acquisition).

NOTE. This subgroup is available in the Real Time S/A (real-time spectrum analysis), the Demod (modulation analysis), and the Time (time analysis) modes.

Command Tree

Header	Parameter
[:SENSe]	
:BSIZE	<numeric_value>

[:SENSe]:BSIZE(?)

Sets or queries the block size.

Syntax

[:SENSe]:BSIZE <value>

[:SENSe]:BSIZE?

Arguments

<value>::=<NR1> specifies the block size. The range depends on the trigger mode set using the :TRIGger[:SEQuence]:MODE command as shown in Table 2-93.

Table 2-93: Block size setting range

Trigger mode	Block size
AUTO	1 to 16000 (standard) / 64000 (Option 02)
NORMal	5 to 16000 (standard) / 64000 (Option 02)

Measurement Modes

SARTIME, SAZRTIME, all Demod modes, all Time modes

Examples

:SENSe:BSIZE 8
sets the block size to 8.

Related Commands

:TRIGger[:SEQuence]:MODE

[[:SENSe]:CCDF Subgroup

The [[:SENSe]:CCDF commands set up the conditions related to the CCDF measurement.

NOTE. To use a command from this group, you must have selected *TIMCCDF* (CCDF measurement) in the *:INSTRument[:SElect]* command.

Command Tree	Header	Parameter
	[[:SENSe]	
	:CCDF	
	:BLOCk	<numeric_value>
	:CLEAr	
	:RMEasurement	
	:THReshold	<numeric_value>

[:SENSe]:CCDF:BLOCK(?)

Sets or queries the number of the block to measure in the CCDF analysis.

Syntax [:SENSe]:CCDF:BLOCK <value>

[:SENSe]:CCDF:BLOCK?

Arguments <value>: :=<NR1> specifies the block number. Zero represents the latest block.
Range: -M to 0 (M: Number of acquired blocks)

Measurement Modes TIMCCDF

Examples :SENSe:CCDF:BLOCK -5
sets the block number to -5.

[:SENSe]:CCDF:CLEAr (No Query Form)

Clears the CCDF accumulator and restarts the measurement.
This command is equivalent to the [:SENSe]:CCDF:RMEasurement command.

Syntax [:SENSe]:CCDF:CLEAr

Arguments None

Measurement Modes TIMCCDF

Examples :SENSe:CCDF:CLEAr
clears the CCDF accumulator and restarts the measurement.

Related Commands [:SENSe]:CCDF:RMEasurement

[:SENSe]:CCDF:RMEasurement (No Query Form)

Clears the CCDF accumulator and restarts the measurement.
This command is equivalent to the [:SENSe]:CCDF:CLEar command.

Syntax [:SENSe]:CCDF:RMEasurement

Arguments None

Measurement Modes TIMCCDF

Examples :SENSe:CCDF:RMEasurement
clears the CCDF accumulator and restarts the measurement.

Related Commands [:SENSe]:CCDF:CLEar

[:SENSe]:CCDF:THReshold(?)

Sets or queries the threshold which defines the samples to be included in the CCDF calculation.

Syntax [:SENSe]:CCDF:THReshold <value>
[:SENSe]:CCDF:THReshold?

Arguments <value>::=<NR1> specifies the threshold. Range: -250 to 130 dBm.

Measurement Modes TIMCCDF

Examples :SENSe:CCDF:THReshold 50dBm
sets the threshold to 50 dBm.

[:SENSe]:CFrequency Subgroup

The [:SENSe]:CFrequency commands set up the conditions related to the carrier frequency measurement.

Command Tree	Header [:SENSe] :CFrequency :CRESolution	Parameter <numeric_value>
Prerequisites for Use	To use a command from this group, you must have run at least the following two commands: <ol style="list-style-type: none"> 1. Run the following command to set the measurement mode to S/A: <pre style="margin-left: 40px;">INSTRument[:SElect] { SANORMAL SASGRAM SARTIME SAUL3G SADLR5_3G }</pre> 2. Run one of the following commands to start the carrier frequency measurement: <ul style="list-style-type: none"> ■ To start the measurement with the default settings: <pre style="margin-left: 40px;">:CONFigure:SPECTrum:CFrequency</pre> ■ To start the measurement without modifying the current settings: <pre style="margin-left: 40px;">[:SENSe]:SPECTrum:MEASurement CFrequency</pre> 	

[:SENSe]:CFrequency:CRESolution(?)

Sets or queries the counter resolution for the carrier frequency measurement.

Syntax	[:SENSe]:CFrequency:CRESolution <value> [:SENSe]:CFrequency:CRESolution?
Arguments	<value>::=<NRf> specifies the counter resolution. Setting value (Hz): 0.001, 0.01, 0.1, 1, 10, 100, 1k, 10k, 100k, or 1M
Measurement Modes	All S/A modes
Examples	:SENSe:CFrequency:CRESolution 1kHz sets the counter resolution to 1 kHz.

[:SENSe]:CHPower Subgroup

The [:SENSe]:CHPower commands set up the conditions related to the channel power measurement.

Command Tree	Header	Parameter
	[:SENSe]	
	:CHPower	
	:BANDwidth :BWIDTH	
	:INTEgration	<numeric_value>
	:FILTer	
	:COEFFicient	<numeric_value>
	:TYPE	RECTangle GAUSSian NYQuist RNYQuist

Prerequisites for Use To use a command from this group, you must have run at least the following two commands:

1. Run the following command to set the measurement mode to S/A:

```
INSTRument[:SElect] { SANORMAL | SASGRAM | SARTIME  
| SAUL3G }
```

2. Run one of the following commands to start the channel power measurement:

- To start the measurement with the default settings:
:CONFIgure:SPECTrum:CHPower
- To start the measurement without modifying the current settings:
[:SENSe]:SPECTrum:MEASurement CHPower

[[:SENSe]:CHPower:BANDwidth|:BWIDth:INTEgration(?)]

Sets or queries the channel bandwidth for the channel power measurement (see Figure 2-20).

Syntax [[:SENSe]:CHPower:BANDwidth|:BWIDth:INTEgration <value>

[[:SENSe]:CHPower:BANDwidth|:BWIDth:INTEgration?

Arguments <value>: :=<NRf> specifies the channel bandwidth for the channel power measurement. Range: (Bin bandwidth) × 8 to full span [Hz]. Refer to the *RSA3408A User Manual* for the bin bandwidth.

Measurement Modes SANORMAL, SASGRAM, SARTIME, SAUL3G

Examples :SENSe:CHPower:BANDwidth:INTEgration 2.5MHz
sets the channel bandwidth to 2.5 MHz.

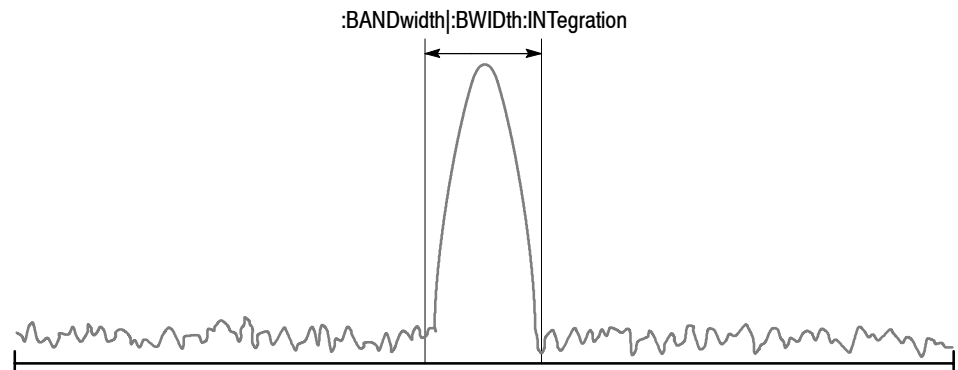

NOTE: Command header [[:SENSe]:CHPower] is omitted here.

Figure 2-20: Setting up the channel power measurement

[:SENSe]:CHPower:FILTer:COEFFicient(?)

Sets or queries the roll-off rate of the filter for the channel power measurement when you have selected either NYQuist (Nyquist filter) or RNYQuist (Root Nyquist filter) in the [:SENSe]:CHPower:FILTer:TYPE command.

Syntax [:SENSe]:CHPower:FILTer:COEFFicient <ratio>
[:SENSe]:CHPower:FILTer:COEFFicient?

Arguments <ratio>::=<NRf> specifies the roll-off rate of the filter for the channel power measurement. Range: 0.0001 to 1 (default: 0.5)

Measurement Modes SANORMAL, SASGRAM, SARTIME, SAUL3G

Examples :SENSe:CHPower:FILTer:COEFFicient 0.3
sets the filter roll-off rate to 0.3.

Related Commands [:SENSe]:CHPower:FILTer:TYPE

[:SENSe]:CHPower:FILTer:TYPE(?)

Selects or queries the filter for the channel power measurement.

Syntax [:SENSe]:CHPower:FILTer:TYPE { RECTangle | GAUSSian | NYQuist
| RNYQuist }
[:SENSe]:CHPower:FILTer:TYPE?

Arguments RECTangle selects the rectangular filter.
GAUSSian selects the Gaussian filter.
NYQuist selects the Nyquist filter (default).
RNYQuist selects the Root Nyquist filter.

Measurement Modes SANORMAL, SASGRAM, SARTIME, SAUL3G

Examples :SENSe:CHPower:FILTer:TYPE RNYQuist
selects the Root Nyquist filter.

[[:SENSe]:CNRatio Subgroup

The [[:SENSe]:CNRatio commands set up the conditions related to the carrier-to-noise ratio (C/N) measurement.

Command Tree	Header	Parameter
	[[:SENSe]	
	:CNRatio	
	:BANDwidth :BWIDth	
	:INTEgration	<frequency>
	:NOISe	<frequency>
	:FILTer	
	:COEFFicient	<numeric_value>
	:TYPE	RECTangle GAUSSian NYQuist RNYQuist
	:OFFSet	<frequency>

Prerequisites for Use

To use a command from this group, you must have run at least the following two commands:

1. Run the following command to set the measurement mode to S/A:

```
INSTrument[:SElect] { SANORMAL | SASGRAM | SARTIME }
```
2. Run one of the following commands to start the C/N measurement:
 - To start the measurement with the default settings:

```
:CONFigure:SPECTrum:CNRatio
```
 - To start the measurement without modifying the current settings:

```
[[:SENSe]:SPECTrum:MEASurement CNRatio
```

[[:SENSe]:CNRatio:BANDwidth]:BWIDth:INTegration(?)

Sets or queries the channel bandwidth for the C/N measurement (see Figure 2-21).

Syntax [:SENSe]:CNRatio:BANDwidth|:BWIDth:INTegration <value>
 [:SENSe]:CNRatio:BANDwidth|:BWIDth:INTegration?

Arguments <value>: :=<NRf> is the carrier bandwidth for the C/N measurement.
 Range: (Bin bandwidth) × 8 to full span [Hz].
 Refer to the *RSA3408A User Manual* for the bin bandwidth.

Measurement Modes SANORMAL, SASGRAM, SARTIME

Examples :SENSe:CNRatio:BANDwidth:INTegration 1MHz
 sets the carrier bandwidth to 1 MHz.

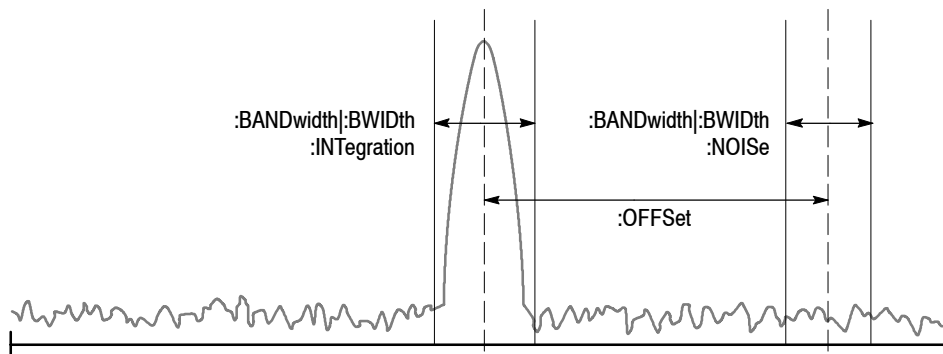

NOTE: Command header [:SENSe]:CNRatio is omitted here.

Figure 2-21: Setting up the C/N measurement

[[:SENSe]:CNRatio:BANDwidth]:BWIDth:NOISe(?)

Sets or queries the noise bandwidth for the C/N measurement (see Figure 2-21).

Syntax [:SENSe]:CNRatio:BANDwidth|:BWIDth:NOISe <value>
 [:SENSe]:CNRatio:BANDwidth|:BWIDth:NOISe?

Arguments <value>::=<NRf> is the noise bandwidth for the C/N measurement.
 Range: (Bin bandwidth) × 8 to full span [Hz].
 Refer to the *RSA3408A User Manual* for the bin bandwidth.

Measurement Modes SANORMAL, SASGRAM, SARTIME

Examples :SENSe:CNRatio:BANDwidth:NOISe 1.5MHz
 sets the noise bandwidth to 1.5 MHz.

[[:SENSe]:CNRatio:FILTer:COEFFicient(?)

Sets or queries the roll-off rate of the filter for the C/N measurement when you have selected either NYQuist (Nyquist filter) or RNYQuist (Root Nyquist filter) in the [[:SENSe]:CNRatio:FILTer:TYPE command.

Syntax [[:SENSe]:CNRatio:FILTer:COEFFicient <value>
[[:SENSe]:CNRatio:FILTer:COEFFicient?

Arguments <value>::=<NRf> is the filter roll-off rate. Range: 0.0001 to 1 (default: 0.5)

Measurement Modes SANORMAL, SASGRAM, SARTIME

Examples :SENSe:CNRatio:FILTer:COEFFicient 0.3
sets the filter roll-off rate to 0.3.

Related Commands [[:SENSe]:CNRatio:FILTer:TYPE

[[:SENSe]:CNRatio:FILTer:TYPE(?)

Selects or queries the filter for the C/N measurement.

Syntax [[:SENSe]:CNRatio:FILTer:TYPE { RECTangle | GAUSSian | NYQuist |
RNYQuist }
[[:SENSe]:CNRatio:FILTer:TYPE?

Arguments RECTangle selects the rectangular filter.
GAUSSian selects the Gaussian filter.
NYQuist selects the Nyquist filter (default).
RNYQuist selects the Root Nyquist filter.

Measurement Modes SANORMAL, SASGRAM, SARTIME

Examples :SENSe:CNRatio:FILTer:TYPE RNYQuist
selects the Root Nyquist filter.

[:SENSe]:CNRatio:OFFSet(?)

Sets or queries offset from the carrier to noise in the the C/N measurement (see Figure 2-21).

Syntax [:SENSe]:CNRatio:OFFSet <freq>

 [:SENSe]:CNRatio:OFFSet?

Arguments <freq>::=<NRf> specifies the offset frequency. Range: -(Span)/2 to +(Span)/2

Measurement Modes SANORMAL, SASGRAM, SARTIME

Examples :SENSe:CNRatio:OFFSet 5MHz
 sets the offset frequency to 5 MHz.

[[:SENSe]:CORRection Subgroup

The [[:SENSe]:CORRection commands control the amplitude correction. For details on the amplitude correction, refer to the *RSA3408A User Manual*.

NOTE. This subgroup is available in the S/A (spectrum analysis) mode except real-time. You must have selected a S/A mode (except SARTIME and SAZRTIME) using the :INSTRument[:SElect] command to use a command in this subgroup but only [[:SENSe]:CORRection[:MAGNitude] command which is available in all the measurement modes.

Command Tree	Header	Parameter
	[[:SENSe]	
	:CORRection	
	:DATA	#<Num_digit><Num_byte> <Freq(1)><Ampl(1)> <Freq(2)><Ampl(2)>... <Freq(n)><Ampl(n)>
	:DELeTe	
	:OFFSet	
	[:MAGNitude]	<numeric_value>
	:FREQency	<numeric_value>
	[[:STATe]	
	:X	
	:SPACing	LINear LOGarithmic
	:Y	
	:SPACing	LINear LOGarithmic

[[:SENSe]:CORRection:DATA(?)]

Sets or queries the amplitude correction data.

Syntax [:SENSe]:CORRection:DATA #<Num_digit><Num_byte>
 <Freq(1)><Amp1(1)><Freq(2)><Amp1(2)>...<Freq(n)><Amp1(n)>
 [:SENSe]:CORRection:DATA?

Arguments <Num_digit> is the number of digits in <Num_byte>.
 <Num_byte> is the number of bytes of the data that follow.
 <Freq(n)> is the frequency at correction point in Hz.
 4-byte little endian floating-point format specified in IEEE 488.2
 <Amp1(n)> is the amplitude correction value at frequency <Freq(n)> in dB.
 4-byte little endian floating-point format specified in IEEE 488.2
 Enter the data that consists of pairs of the frequency and amplitude correction
 values (n: Max 3000).

Measurement Modes All S/A modes except SARTIME and SAZRTIME

Examples :SENSe:CORRection:DATA #41024xxxx...
 sets the correction values at 1024 points.

[[:SENSe]:CORRection:DELeTe (No Query Form)]

Deletes all the amplitude correction data.

Syntax [:SENSe]:CORRection:DELeTe

Arguments None

Measurement Modes All S/A modes except SARTIME and SAZRTIME

Examples :SENSe:CORRection:DELeTe
 deletes all the amplitude correction data.

[:SENSe]:CORRection:OFFSet[:MAGNitude](?)

Sets or queries the amplitude offset value in the amplitude correction.

Syntax [:SENSe]:CORRection:OFFSet[:MAGNitude] <value>
 [:SENSe]:CORRection:OFFSet[:MAGNitude]?

Arguments <value>::=<NRf> specifies the amplitude offset value.
 Range: -200 to +200 dB.

Measurement Modes All

Examples :SENSe:CORRection:OFFSet:MAGNitude 10
 sets the amplitude offset value to 10 dB.

Related Commands [:SENSe]:CORRection:OFFSet:STATe

[:SENSe]:CORRection:OFFSet:FREQuency(?)

Sets or queries the frequency offset value in the amplitude correction.

Syntax [:SENSe]:CORRection:OFFSet:FREQuency <value>
 [:SENSe]:CORRection:OFFSet:FREQuency?

Arguments <value>::=<NRf> specifies the frequency offset value.
 Range: -100 GHz to +100 GHz.

Measurement Modes All S/A modes except SARTIME and SAZRTIME

Examples :SENSe:CORRection:OFFSet:FREQuency 10MHz
 sets the frequency offset value to 10 MHz.

Related Commands [:SENSe]:CORRection:OFFSet:STATe

[:SENSe]:CORRection[:STATe](?)

Determines whether to turn the amplitude correction on or off.

Syntax [:SENSe]:CORRection[:STATe] { OFF | ON | 0 | 1 }
[:SENSe]:CORRection[:STATe]?

Arguments OFF or 0 turns off the amplitude correction.
ON or 1 turns on the amplitude correction.

Measurement Modes All S/A modes except SARTIME and SAZRTIME

Examples :SENSe:CORRection:STATe ON
turns on the amplitude correction.

[[:SENSe]:CORRection:X:SPACing(?)

Determines whether the horizontal, or frequency, scaling is linear or logarithmic for interpolation of amplitude correction data.

Syntax [:SENSe]:CORRection:X:SPACing { LINear | LOGarithmic }

[:SENSe]:CORRection:X:SPACing?

Arguments LINear selects the linear scale for the interpolation.

LOGarithmic selects the logarithmic scale for the interpolation.

Measurement Modes All S/A modes except SARTIME and SAZRTIME

Examples :SENSe:CORRection:X:SPACing LINear
selects the linear scale for the interpolation.

[[:SENSe]:CORRection:Y:SPACing(?)

Determines whether the vertical, or amplitude, scaling is linear or logarithmic for interpolation of amplitude correction data.

Syntax [:SENSe]:CORRection:Y:SPACing { LINear | LOGarithmic }

[:SENSe]:CORRection:Y:SPACing?

Arguments LINear selects the linear scale for the interpolation.

LOGarithmic selects the logarithmic scale for the interpolation.

Measurement Modes All S/A modes except SARTIME and SAZRTIME

Examples :SENSe:CORRection:Y:SPACing LINear
selects the linear scale for the interpolation.

[:SENSe]:EBWidth Subgroup

The [:SENSe]:EBWidth commands set up the conditions related to the emission bandwidth (EBW) measurement.

Command Tree	Header	Parameter
	[:SENSe]	
	:EBWidth	
	:XDB	<numeric_value>

Prerequisites for Use To use a command from this group, you must have run at least the following two commands:

1. Run the following command to set the measurement mode to S/A:

```
:INSTrument[:SElect] { SANORMAL | SASGRAM | SARTIME
| SAUL3G }
```

2. Run one of the following commands to start an EBW measurement:

- To start the measurement with the default settings:
:CONFigure:SPECTrum:EBWidth
- To start the measurement without modifying the current settings:
[:SENSe]:SPECTrum:MEASurement EBWidth

[[:SENSe]:EBWidth:XDB(?)

Sets or queries the level relative to the maximum peak at which the EBW is measured (see Figure 2-22).

Syntax [[:SENSe]:EBWidth:XDB <rel_amp1>
 [[:SENSe]:EBWidth:XDB?

Arguments <rel_amp1>::=<NRf> is the level at which the EBW is measured.
 Specify the amplitude relative to the maximum peak.
 Range: -100 to -1 dB (default: -30 dB).

Measurement Modes SANORMAL, SASGRAM, SARTIME, SAUL3G

Examples :SENSe:EBWidth:XDB -20
 specifies that the EBW is measured at a level -20 dB lower than the maximum peak.

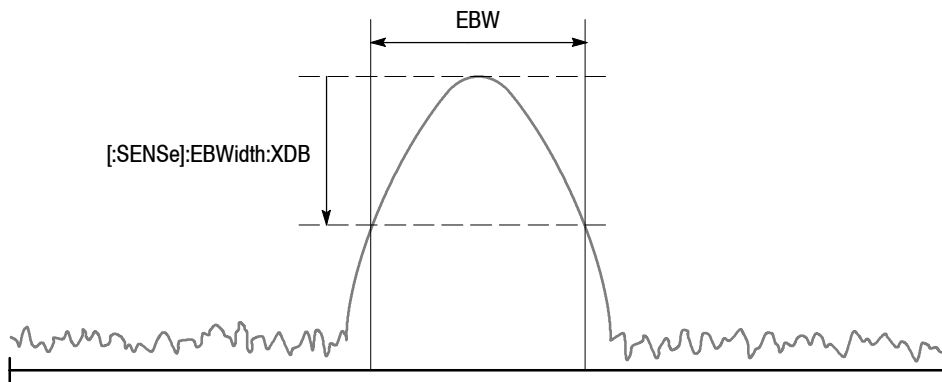

Figure 2-22: Setting up the EBW measurement

[:SENSe]:FEED Subgroup

The [:SENSe]:FEED commands select the input signal.

Command Tree	Header	Parameter
	[:SENSe]	
	:FEED	RF IQ AREFERENCE

[:SENSe]:FEED (No Query Form)

Selects the input signal: RF input or calibration signal.

Syntax [:SENSe]:FEED { RF | IQ | AREFERENCE }

Arguments RF selects the RF input.
 IQ selects the IQ input (Option 03 only).
 AREFERENCE selects the internal calibration signal.

Measurement Modes All

Examples :SENSe:FEED RF
 selects the RF input.

[:SENSe]:FREQUency Subgroup

The [:SENSe]:FREQUency commands set up the frequency-related conditions.

Command Tree	Header	Parameter
	[:SENSe]	
	:FREQUency	
	:BAND?	
	:CENTer	<frequency>
	:STEP	<frequency>
	:AUTO	<boolean>
	[:INCRement]	<frequency>
	:CHANnel	<numeric_value>
	:CTABle	
	:CATalog?	
	[:SElect]	<table_name>
	:SPAN	<frequency>
	:STARt	<frequency>
	:STOP	<frequency>

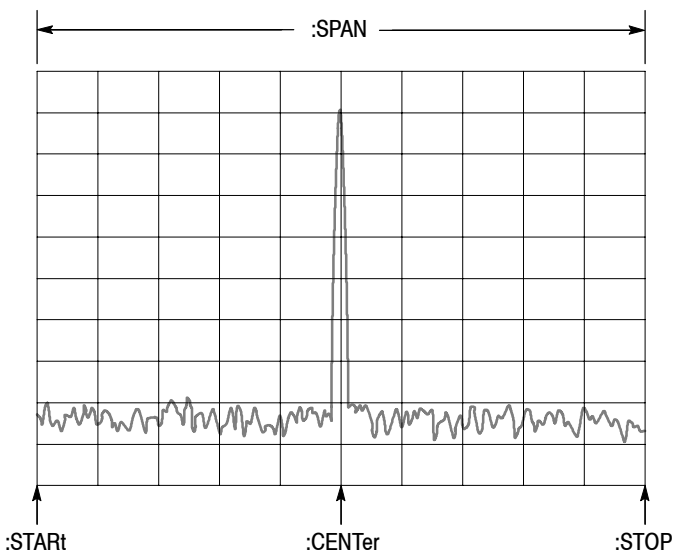

NOTE: Command header [:SENSe]:FREQUency is omitted here.

Figure 2- 23: Setting frequency and span

[[:SENSe]:FREQUENCY:BAND? (Query Only)

Queries the measurement frequency band.

Syntax [[:SENSe]:FREQUENCY:BAND?

Returns Table 2-94 shows the returned values and corresponding ranges:

Table 2-94: Measurement frequency bands

Returned value	Frequency range
BAS	DC to 40 MHz
RF1B	40 MHz to 3.5 GHz
RF2B	3.5 to 6.5 GHz
RF3B	5 to 8 GHz

Measurement Modes All

Examples :SENSe:FREQUENCY:BAND?
might return RF1B.

[[:SENSe]:FREQUENCY:CENTER(?)

Sets or queries the center frequency.

Syntax [[:SENSe]:FREQUENCY:CENTER <freq>
[[:SENSe]:FREQUENCY:CENTER?

Arguments <freq>: =<NRf> specifies the center frequency. For the setting range, refer to Table 2-94 on page 2-1073.

Measurement Modes All

Examples :SENSe:FREQUENCY:CENTER 800MHz
sets the center frequency to 800 MHz.

Related Commands [[:SENSe]:FREQUENCY:BAND

[[:SENSe]:FREQuency:CENTer:STEP:AUTO(?)]

Determines whether to automatically set the step size (amount per click by which the up and down keys change a setting value) of the center frequency by the span setting.

Syntax [:SENSe]:FREQuency:CENTer:STEP:AUTO { OFF | ON | 0 | 1 }
[:SENSe]:FREQuency:CENTer:STEP:AUTO?

Arguments OFF or 0 specifies that the step size of the center frequency is not set automatically. To set it, use the [:SENSe]:FREQuency:CENTer:STEP[:INCRement] command.

ON or 1 specifies that the step size of the center frequency is set automatically by the span.

Measurement Modes All

Examples :SENSe:FREQuency:CENTer:STEP:AUTO ON
 specifies that the step size of the center frequency is set automatically.

Related Commands [:SENSe]:FREQuency:CENTer:STEP[:INCRement]

[:SENSe]:FREQUENCY:CENTer:STEP[:INCRement](?)

Sets or queries the step size (amount per click by which the up and down keys change a setting value) of the center frequency when [:SENSe]:FREQUENCY:CENTer:STEP:AUTO is OFF.

NOTE. *This command is effective only in remote operation. It does not affect the front panel setting of the frequency step size.*

Syntax [:SENSe]:FREQUENCY:CENTer:STEP[:INCRement] <freq>
 [:SENSe]:FREQUENCY:CENTer:STEP[:INCRement]?

Arguments <freq>::=<NRf> is the step size of the center frequency.

Measurement Modes All

Examples :SENSe:FREQUENCY:CENTer:STEP:INCRement 10kHz
 sets the step size of the center frequency to 10 kHz.

Related Commands [:SENSe]:FREQUENCY:CENTer:STEP:AUTO

[:SENSe]:FREQuency:CHANnel(?)

Sets or queries a channel number in the channel table specified using the [:SENSe]:FREQuency:CTABLE[:SELEct] command.

Syntax [:SENSe]:FREQuency:CHANnel <value>
[:SENSe]:FREQuency:CHANnel?

Arguments <value>: :=<NR1> specifies a channel number in the channel table.

Measurement Modes All

Examples :SENSe:FREQuency:CHANnel 10558
sets the channel number to 10558 for the W-CDMA downlink analysis.

Related Commands [:SENSe]:FREQuency:CTABLE[:SELEct]

[:SENSe]:FREQuency:CTABLE:CATalog? (Query Only)

Queries the available channel tables.

Syntax [:SENSe]:FREQuency:CTABLE:CATalog?

Returns <string> is the available channel table name(s). If more than one table is available, the table names are separated with comma. Refer to the [:SENSe]:FREQuency:CTABLE[:SELEct] command below for the table names.

Measurement Modes All

Examples :SENSe:FREQuency:CTABLE:CATalog?
a partial return string may look like this:
"CDMA2000 EU PAMR400-FL","CDMA2000 EU PAMR400-RL","CDMA2000 EU PAMR800-FL","CDMA2000 EU PAMR800-RL",...

Related Commands [:SENSe]:FREQuency:CTABLE[:SELEct]

[[:SENSe]:FREQuency:CTABle[:SElect](?)

Selects the channel table. The query command returns the selected channel table.

Syntax [[:SENSe]:FREQuency:CTABle[:SElect] <table>

[[:SENSe]:FREQuency:CTABle[:SElect]?

Arguments <table>::=<string> specifies a channel table. The table name is represented with the communication standard name followed by “-FL” (forward link), “-RL” (reverse link), “-UL” (uplink), or “-DL” (downlink).

The following channel tables are available:

None (does not use channel tables)
 CDMA2000 EU PAMR400-FL CDMA2000 EU PAMR400-RL
 CDMA2000 EU PAMR800-FL CDMA2000 EU PAMR800-RL
 CDMA2000 GSM BAND 1-FL CDMA2000 GSM BAND 1-RL
 CDMA2000 GSM BAND 2-FL CDMA2000 GSM BAND 2-RL
 CDMA2000 IMT2000-FL CDMA2000 IMT2000-RL
 CDMA2000 JTACS BAND-FL CDMA2000 JTACS BAND-RL
 CDMA2000 KOREA PCS-FL CDMA2000 KOREA PCS-RL
 CDMA2000 N.A. 700MHz Cellular-FL
 CDMA2000 N.A. 700MHz Cellular-RL
 CDMA2000 N.A. Cellular-FL CDMA2000 N.A. Cellular-RL
 CDMA2000 N.A. PCS-FL CDMA2000 N.A. PCS-RL
 CDMA2000 NMT450 20k-FL CDMA2000 NMT450 20k-RL
 CDMA2000 NMT450 25k-FL CDMA2000 NMT450 25k-RL
 CDMA2000 SMR800-FL CDMA2000 SMR800-RL
 CDMA2000 TACS BAND-FL CDMA2000 TACS BAND-RL
 DCS1800-DL DCS1800-UL GSM850-DL GSM850-UL
 GSM900-DL GSM900-UL IEEE802.11a IEEE802.11b/g
 NMT450-DL NMT450-UL PCS1900-DL PCS1900-UL
 TD-SCDMA W-CDMA-DL W-CDMA-UL

The table name must be within quotation marks for the argument.

Measurement Modes All

Examples :SENSe:FREQuency:CTABle:SElect "W-CDMA-DL"
 selects the W-CDMA downlink channel table.

Related Commands [[:SENSe]:FREQuency:CTABle:CATalog?

[[:SENSe]:FREQUENCY:SPAN(?)]

Sets or queries the span.

NOTE. The center, start, and stop frequencies and the span are interrelated as follows:

$$(\text{Stop frequency} + \text{Start frequency}) / 2 = \text{Center frequency}$$

$$\text{Stop frequency} - \text{Start frequency} = \text{Span}$$

When you set one of these, all the other settings are automatically changed correspondingly.

Syntax [[:SENSe]:FREQUENCY:SPAN <freq>

[[:SENSe]:FREQUENCY:SPAN?

Arguments <freq> ::= <NRf> specifies the span. The valid range depends on the measurement mode as listed in Table 2-95:

Table 2-95: Span setting

Measurement mode	Frequency band	Setting range
All S/A modes except SARTIME and SAZRTIME	RF	50 Hz to 3 GHz (continuous)
	Baseband	50 Hz to 40 MHz (continuous)
Other than above	RF	100 Hz to 20 MHz (1-2-5 sequence), 36 MHz
	Baseband	100 Hz to 40 MHz (1-2-5 sequence)

Measurement Modes All

Examples :SENSe:FREQUENCY:SPAN 1MHz
sets the span to 1 MHz.

Related Commands [[:SENSe]:FREQUENCY:CENTer, [[:SENSe]:FREQUENCY:STARt, [[:SENSe]:FREQUENCY:STOP

[:SENSe]:FREQUENCY:START(?)

Sets or queries the start frequency.

Syntax [:SENSe]:FREQUENCY:START <freq>
 [:SENSe]:FREQUENCY:START?

Arguments <freq>: :=<NRf> specifies the start frequency. For the setting range, refer to Table 2-94 on page 2-1073.

Measurement Modes SANORMAL, SASGRAM, SADLR5_3G

Examples :SENSe:FREQUENCY:START 800MHz
 sets the start frequency to 800 MHz.

Related Commands [:SENSe]:FREQUENCY:CENTER, [:SENSe]:FREQUENCY:SPAN,
 [:SENSe]:FREQUENCY:STOP

[:SENSe]:FREQUENCY:STOP(?)

Syntax [:SENSe]:FREQUENCY:STOP <freq>
 [:SENSe]:FREQUENCY:STOP?

Arguments <freq>: :=<NRf> specifies the stop frequency. For the setting range, refer to Table 2-94 on page 2-1073.

Measurement Modes SANORMAL, SASGRAM, SADLR5_3G

Examples :SENSe:FREQUENCY:STOP 1GHz
 sets the stop frequency to 1 GHz.

Related Commands [:SENSe]:FREQUENCY:CENTER, [:SENSe]:FREQUENCY:SPAN,
 [:SENSe]:FREQUENCY:START

[[:SENSe]:OBWidth Subgroup

The [[:SENSe]:OBWidth commands set the conditions related to the occupied bandwidth (OBW) measurement.

Command Tree	Header	Parameter
	[SENSe]	
	:OBWidth	
	:PERCent	<numeric_value>

Prerequisites for Use

To use a command from this group, you must have run at least the following two commands:

1. Run the following command to set the measurement mode to S/A:

```
:INSTRument[:SElect] { SANORMAL | SASGRAM | SARTIME  
| SAUL3G }
```

2. Run one of the following commands to start the OBW measurement:

- To start the measurement with the default settings:
:CONFIgure:SPECTrum:OBWidth
- To start the measurement without modifying the current settings:
[:SENSe]:SPECTrum:MEASurement OBWidth

[[:SENSe]:OBWidth:PERCent(?)]

Sets or queries the occupied bandwidth for the OBW measurement.

Syntax [[:SENSe]:OBWidth:PERCent <value>
[[:SENSe]:OBWidth:PERCent?

Arguments <value>::=<NRf> specifies the occupied bandwidth.
Range: 80 to 99.99% (default: 99%)

Measurement Modes SANORMAL, SASGRAM, SARTIME, SAUL3G

Examples :SENSe:OBWidth:PERCent 95
sets the occupied bandwidth to 95%.

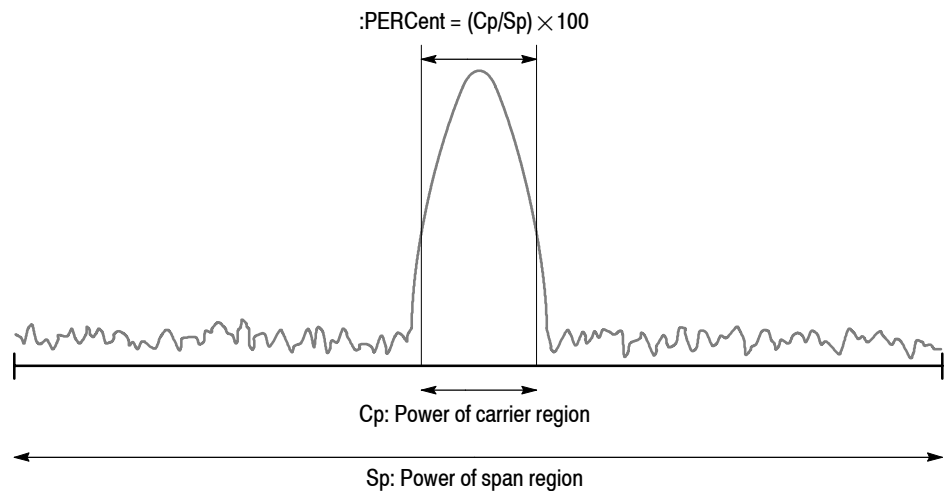

NOTE: The command header [[:SENSe]:OBWidth is omitted here.

Figure 2-24: Setting up the OBW measurement

[[:SENSe]:PULSe Subgroup

The [[:SENSe]:PULSe commands set up the conditions related to the pulse characteristics analysis.

NOTE. To use a command from this group, you must have selected *TIMPULSE* (pulse characteristics analysis) in the *:INSTrument[:SELEct]* command.

Command Tree	Header	Parameter
	[[:SENSe]	
	:PULSe	
	:BLOCK	
	:CHPower	
	:BANDwidth :BWIDth	
	:INTEgration	<numeric_value>
	:CRESolution	<numeric_value>
	:EBWidth	
	:XDB	<numeric_value>
	:FFT	
	:COEFFicient	<numeric_value>
	:WINDow	
	[:TYPE]	NYQuist BH4B
	:FILTer	
	:BANDwidth :BWIDth	<numeric_value>
	:COEFFicient	<numeric_value>
	:MEASurement	OFF GAUSSian
	:FREQuency	
	:OFFSet	<numeric_value>
	:RECOvery	FIRST USER OFF
	[:IMMediate]	
	:LENGth	<numeric_value>
	:OBWidth	
	:PERCent	<numeric_value>
	:OFFSet	<numeric_value>
	:PTOFFset	<numeric_value>
	:THReshold	<numeric_value>

[[:SENSe]:PULSe:BLOCK(?)]

Sets or queries the number of the block to measure in the pulse characteristics analysis.

Syntax [[:SENSe]:PULSe:BLOCK <value>

[[:SENSe]:PULSe:BLOCK?

Arguments <value>::=<NR1> specifies the block number. Zero represents the latest block. Range: -M to 0 (M: the number of acquired blocks)

Measurement Modes TIMPULSE

Examples :SENSe:PULSe:BLOCK -5
sets the block number to -5.

[[:SENSe]:PULSe:CHPower:BANDwidth|:BWIDth:INTEgration(?)]

Sets or queries the channel bandwidth for the channel power measurement in the pulse characteristics analysis.

Syntax [[:SENSe]:PULSe:CHPower:BANDwidth|:BWIDth:INTEgration <value>

[[:SENSe]:PULSe:CHPower:BANDwidth|:BWIDth:INTEgration?

Arguments <value>::=<NRf> is the channel bandwidth for the channel power measurement. Range: (Bin bandwidth) × 8 to full span [Hz]. Refer to the *RSA3408A User Manual* for the bin bandwidth.

Measurement Modes TIMPULSE

Examples :SENSe:PULSe:CHPower:BANDwidth:INTEgration 1.5MHz
sets the channel bandwidth to 1.5 MHz.

[[:SENSe]:PULSe:CRESolution(?)

Sets or queries the frequency measurement resolution in the pulse characteristics analysis.

Syntax `[[:SENSe]:PULSe:CRESolution <value>`

`[[:SENSe]:PULSe:CRESolution?`

Arguments `<value>::={ 1 | 10 | 100 | 1k | 10k | 100k | 1M } [Hz]` specifies the frequency measurement resolution.

Measurement Modes TIMPULSE

Examples `:SENSe:PULSe:CRESolution 1kHz`
sets the frequency measurement resolution to 1 kHz.

[[:SENSe]:PULSe:EBWidth:XDB(?)

Sets or queries the level relative to the maximum peak at which the EBW is measured in the pulse characteristics analysis. Refer to the [[:SENSe]:EBWidth:XDB command on page 2-1070.

Syntax `[[:SENSe]:PULSe:EBWidth:XDB <value>`

`[[:SENSe]:PULSe:EBWidth:XDB?`

Arguments `<value>::=<NRf>` is the level at which the EBW is measured. Specify the amplitude relative to the maximum peak.
Range: -100 to -1 dB (default: -30 dB)

Measurement Modes TIMPULSE

Examples `:SENSe:PULSe:EBWidth:XDB -20`
specifies that the EBW is measured at a level -20 dB lower than the maximum peak.

Related Commands [[:SENSe]:EBWidth:XDB

[[:SENSE]:PULSE:FFT:COEFFICIENT(?)]

Sets or queries the roll-off ratio when the FFT window type is Nyquist in the pulse characteristics analysis.

Syntax [[:SENSE]:PULSE:FFT:COEFFICIENT <value>

[[:SENSE]:PULSE:FFT:COEFFICIENT?

Arguments <value>::=<NRf> specifies the roll-off ratio. Range: 0.0001 to 1.0 (default: 0.2)

Measurement Modes TIMPULSE

Examples :SENSE:PULSE:FFT:COEFFICIENT 0.5
sets the roll-off ratio to 0.5.

Related Commands [[:SENSE]:PULSE:FFT:WINDOW[:TYPE]]

[[:SENSE]:PULSE:FFT:WINDOW[:TYPE](?)]

Selects or queries the FFT window type in the pulse characteristics analysis.

Syntax [[:SENSE]:PULSE:FFT:WINDOW[:TYPE] { NYQUIST | BH4B }

[[:SENSE]:PULSE:FFT:WINDOW[:TYPE]?

Arguments NYQUIST selects the Nyquist window.

BH4B selects the Blackman-Harris 4B type window.

Measurement Modes TIMPULSE

Examples :SENSE:PULSE:FFT:WINDOW:TYPE NYQUIST
selects the Nyquist window.

[[:SENSe]:PULSe:FILTer:BAWdwidth|:BWIth(?]

Sets or queries the bandwidth of the time measurement filter in the pulse characteristics analysis.

Syntax [[:SENSe]:PULSe:FILTer:BAWdwidth|:BWIth <value>

[[:SENSe]:PULSe:FILTer:BAWdwidth|:BWIth?

Arguments <value>::=<NRf> specifies the bandwidth of the time measurement filter. Range: Span/10 to full span.

Measurement Modes TIMPULSE

Examples :SENSe:PULSe:FILTer:BAWdwidth 1MHz
sets the bandwidth of the time measurement filter to 1 MHz.

[[:SENSe]:PULSe:FILTer:COEFFicient(?]

Sets or queries the α /BT value for the measurement filter when [[:SENSe]:PULSe:FILTer:MEASurement is set to GAUSSian.

Syntax [[:SENSe]:PULSe:FILTer:COEFFicient <value>

[[:SENSe]:PULSe:FILTer:COEFFicient?

Arguments <value>::=<NRf> sets the α /BT value for the Gaussian measurement filter. Range: 0.0001 to 1 (default: 0.35)

Measurement Modes TIMPULSE

Examples :SENSe:PULSe:FILTer:COEFFicient 0.5
sets the α /BT value to 0.5.

Related Commands [[:SENSe]:PULSe:FILTer:MEASurement

[[:SENSe]:PULSe:FILTer:MEASurement(?)]

Selects or queries the measurement filter for the time measurement in the pulse characteristics analysis.

Syntax [[:SENSe]:PULSe:FILTer:MEASurement { OFF | GAUSSian }

[[:SENSe]:PULSe:FILTer:MEASurement?

Arguments OFF specifies that no measurement filter is used.

GAUSSian selects the Gaussian filter.

Measurement Modes TIMPULSE

Examples :SENSe:PULSe:FILTer:MEASurement GAUSSian
selects the Gaussian filter.

[[:SENSe]:PULSe:FREQuency:OFFSet(?)]

Sets or queries the frequency offset for the pulse-pulse phase and the frequency deviation measurements in the pulse characteristics analysis.

This command is valid when [[:SENSe]:PULSe:FREQuency:RECovery is set to USER. This query command is valid when [[:SENSe]:PULSe:FREQuency:RECovery is set to FIRSt or USER.

Syntax [[:SENSe]:PULSe:FREQuency:OFFSet <value>

[[:SENSe]:PULSe:FREQuency:OFFSet?

Arguments <value>::=<NRf> specifies the frequency offset. Range: -10 to +10 MHz

Measurement Modes TIMPULSE

Examples :SENSe:PULSe:FREQuency:OFFSet 5MHz
sets the frequency offset to 5 MHz.

Related Commands [[:SENSe]:PULSe:FREQuency:RECovery

[[:SENSe]:PULSe:FREQuency:RECovery(?)

Selects or queries the frequency recovery for the pulse-pulse phase and the frequency deviation measurements in the pulse characteristics analysis.

Syntax [:SENSe]:PULSe:FREQuency:RECovery { FIRSt | USER | OFF }

[:SENSe]:PULSe:FREQuency:RECovery?

Arguments FIRSt specifies that frequency correction is performed for all pulses based on the frequency error value calculated from the first pulse included in the analysis range. The calculated frequency error is shown in the Frequency Offset side key.

USER specifies that all pulses are corrected by the value set up by the [:SENSe]:PULSe:FREQuency:OFFSet command.

OFF disables frequency correction.

Measurement Modes TIMPULSE

Examples :SENSe:PULSe:FREQuency:RECovery FIRSt
specifies that frequency correction is performed using the first pulse.

Related Commands [:SENSe]:PULSe:FREQuency:OFFSet

[[:SENSe]:PULSe[:IMMediate] (No Query Form)

Runs calculation for acquired data in the pulse characteristics analysis. To acquire data, use the :INITiate command.

Syntax [:SENSe]:PULSe[:IMMediate]

Arguments None

Measurement Modes TIMPULSE

Examples :SENSe:PULSe:IMMediate
runs calculation for acquired data.

Related Commands :INITiate

[:SENSe]:PULSe:LENGth(?)

Sets or queries the range for the analog modulation analysis.

Syntax [:SENSe]:PULSe:LENGth <value>
 [:SENSe]:PULSe:LENGth?

Arguments <value>::=<NR1> specifies the analysis range by the number of data points.
 Range: 1 to 1024 × (Block size).
 To set the block size, use the [:SENSe]:BSIZE command.

Measurement Modes TIMPULSE

Examples :SENSe:PULSe:LENGth 1000
 sets the analysis range to 1000 points.

Related Commands [:SENSe]:BSIZE

[:SENSe]:PULSe:OBWidth:PERCent(?)

Sets or queries OBW (Occupied Bandwidth) for the OBW measurement in the pulse characteristics analysis.

Syntax [:SENSe]:PULSe:OBWidth:PERCent <value>
 [:SENSe]:PULSe:OBWidth:PERCent?

Arguments <value>::=<NRf> specifies the occupied bandwidth.
 Range: 80 to 99.9% (default: 99%).

Measurement Modes TIMPULSE

Examples :SENSe:PULSe:OBWidth:PERCent 95
 sets the occupied bandwidth to 95%.

[[:SENSe]:PULSe:OFFSet(?)]

Sets or queries the measurement start position for the pulse characteristics analysis.

Syntax [:SENSe]:PULSe:OFFSet <value>

[:SENSe]:PULSe:OFFSet?

Arguments <value>::=<NR1> specifies the measurement start position by the number of points. Range: 0 to $1024 \times (\text{Block size}) - 1$. To set the block size, use the [:SENSe]:BSIZe command.

Measurement Modes TIMPULSE

Examples :SENSe:PULSe:OFFSet 500
sets the measurement start position to point 500.

Related Commands [:SENSe]:BSIZe

[[:SENSe]:PULSe:PTOFFset(?)]

Sets or queries the time offset for the pulse-pulse phase measurement point.

Syntax [:SENSe]:PULSe:PTOFFset <value>

[:SENSe]:PULSe:PTOFFset?

Arguments <value>::=<NRf> specifies the time offset. Range: 0 to 1 s (the default is 0)
The default value is 0 (zero), that is, the measurement point is at the beginning of the pulse-on time.

Measurement Modes TIMPULSE

Examples :SENSe:PULSe:PTOFFset 1.5m
Sets the time offset to 1.5 ms.

[:SENSe]:PULSe:THReshold(?)

Sets or queries the threshold level to detect pulses in acquired data.

Syntax [:SENSe]:PULSe:THReshold <value>
 [:SENSe]:PULSe:THReshold?

Arguments <value>::=<NRf> specifies the threshold level.
 Range: -100 to 0 dBc (the default is -3 dBc)

Measurement Modes TIMPULSE

Examples :SENSe:PULSe:THReshold -20
 sets the threshold level to -20 dBc.

[[:SENSe]:ROSCillator Subgroup

The [[:SENSe]:ROSCillator commands set up the reference oscillator.

Command Tree	Header	Parameter
	[[:SENSe] :ROSCillator :SOURce	INTernal EXTernal

[[:SENSe]:ROSCillator:SOURce(?)

Selects or queries the reference oscillator.

Syntax [[:SENSe]:ROSCillator:SOURce { INTernal | EXTernal }
[[:SENSe]:ROSCillator:SOURce?

Arguments INTernal selects the internal reference oscillator.
EXTernal selects the external reference oscillator. Connect it to the REF IN connector on the rear panel.

Measurement Modes All

Examples :SENSe:ROSCillator:SOURce EXTernal
selects the external reference oscillator.

[:SENSE]:SPECTrum Subgroup

The [:SENSE]:SPECTrum commands set up the conditions related to the spectrum measurement in the S/A (spectrum analysis) mode.

Command Tree	Header	Parameter
	[:SENSE]	
	:SPECTrum	
	:AVERage	
	:CLEar	
	:COUNT	<numeric_value>
	[:STATE]	<boolean>
	TYPE	RMS MAXimum MINimum
	:BANDwidth :BWIDth	
	[:RESolution]	<numeric_value>
	:AUTO	<boolean>
	:STATE	<boolean>
	:VIDeo	<numeric_value> (Option 21 and 29)
	:STATE	<boolean>
	:SWEep	
	[:TIME]	<numeric_value>
	:DETEctor	
	[:FUNction]	NEGative POSitive PNEGative
	:FILTer	
	:COEFFicient	<numeric_value>
	:TYPE	RECTangle GAUSSian NYquist RNYquist
	:FFT	
	:ERESolution	<boolean>
	:LENGth	<numeric_value>
	:START	<numeric_value>
	:WINDow	
	[:TYPE]	BH3A BH3B BH4A BH4B BLACKman HAMMING HANNing PARZen ROSEnfield WELCh SLOBE SCUBed ST04 FLATtop RECT
	:FRAME	<numeric_value>
	:MEASurement	OFF CHPower ACPower OBWidth EBWidth CNRatio CFRequency

```
:ZOOM
  :BLOCK          <numeric_value>
  :FREQuency
    :CENTer      <numeric_value>
    :WIDTh       <numeric_value>
  :LENGth        <numeric_value>
  :OFFSet       <numeric_value>
```

[:SENSe]:SPEcTrum:AVERAge:CLEAr (No Query Form)

Clears average data and counter, and restarts the averaging process.

Syntax [:SENSe]:SPEcTrum:AVERAge:CLEAr

Arguments None

Measurement Modes All S/A modes except SARTIME and SAZRTIME

Examples :SENSe:SPEcTrum:AVERAge:CLEAr
Clears average data and counter, and restarts the averaging process.

[:SENSe]:SPEcTrum:AVERAge:COUnT(?)

Sets or queries the number of traces to combine using the :TYPE setting (refer to page 2-1096).

Syntax [:SENSe]:SPEcTrum:AVERAge:COUnT <value>
[:SENSe]:SPEcTrum:AVERAge:COUnT?

Arguments <value>::=<NR1> is the number of traces to combine for averaging.
Range: 1 to 10000 (default: 20)

Measurement Modes All S/A modes except SARTIME and SAZRTIME

Examples :SENSe:SPEcTrum:AVERAge:COUnT 64
sets the average count to 64.

Related Commands [:SENSe]:SPEcTrum:AVERAge:TYPE

[[:SENSe]:SPEcTrum:AVERage[:STATe](?)

Determines whether to turn averaging on or off.

Syntax [:SENSe]:SPEcTrum:AVERage[:STATe] { OFF | ON | 0 | 1 }
[:SENSe]:SPEcTrum:AVERage[:STATe]?

Arguments OFF or 0 turns off averaging.
ON or 1 turns on averaging.

Measurement Modes All S/A modes except SARTIME and SAZRTIME

Examples :SENSe:SPEcTrum:AVERage:STATe ON
turns on averaging.

[[:SENSe]:SPEcTrum:AVERage:TYPE(?)

Selects or queries the type of averaging.

Syntax [:SENSe]:SPEcTrum:AVERage:TYPE { RMS | MAXimum | MINimum }
[:SENSe]:SPEcTrum:AVERage:TYPE?

Arguments RMS performs the averaging process with RMS (root-mean-square).
MAXimum retains the maximum value at each data point on the waveform.
MINimum retains the minimum value at each data point on the waveform.

Measurement Modes All S/A modes except SARTIME and SAZRTIME

Examples :SENSe:SPEcTrum:AVERage:TYPE RMS
performs the averaging process with RMS.

[[:SENSE]:SPECTrum:BANDwidth]:BWIDth[:RESolution](?)

Sets or queries the resolution bandwidth (RBW) when [:SENSE]:SPECTrum:BANDwidth]:BWIDth[:RESolution]:AUTO is set to Off.

Syntax [:SENSE]:SPECTrum:BANDwidth]:BWIDth[:RESolution] <freq>
[:SENSE]:SPECTrum:BANDwidth]:BWIDth[:RESolution]?

Arguments <freq>::=<NRf> specifies the RBW.
For the setting range, refer to Table D-1 in *Appendix D*.

Measurement Modes All S/A modes except SARTIME and SAZRTIME

Examples :SENSE:SPECTrum:BANDwidth:RESolution 80kHz
sets the RBW to 80 kHz.

[[:SENSE]:SPECTrum:BANDwidth]:BWIDth[:RESolution]:AUTO(?)

Determines whether to automatically set the resolution bandwidth (RBW) by the span setting.

Syntax [:SENSE]:SPECTrum:BANDwidth]:BWIDth[:RESolution]:AUTO { OFF | ON
| 0 | 1 }
[:SENSE]:SPECTrum:BANDwidth]:BWIDth[:RESolution]:AUTO?

Arguments OFF or 0 specifies that the RBW is not set automatically. To set it, use the [:SENSE]:SPECTrum:BANDwidth]:BWIDth[:RESolution] command.

ON or 1 specifies that the RBW is set automatically.

Measurement Modes All S/A modes except SARTIME and SAZRTIME

Examples :SENSE:SPECTrum:BANDwidth:RESolution:AUTO ON
specifies that the RBW is set automatically.

Related Commands :INSTrument[:SElect]

[[:SENSe]:SPECTrum:BANDwidth]:BWIDth:STATe(?)

Determines whether to perform the resolution bandwidth (RBW) process.

Syntax [:SENSe]:SPECTrum:BANDwidth]:BWIDth:STATe { OFF | ON | 0 | 1 }
[:SENSe]:SPECTrum:BANDwidth]:BWIDth:STATe?

Arguments OFF or 0 specifies that the RBW process is not performed so that a spectrum immediately after the FFT process is displayed on screen.
ON or 1 specifies that the RBW process is performed.

Measurement Modes All S/A modes except SARTIME and SAZRTIME

Examples :SENSe:SPECTrum:BANDwidth:STATe ON
specifies that the resolution bandwidth process is performed.

[[:SENSe]:SPECTrum:BANDwidth]:BWIDth:VIDeo(?)

Option 21 and 29

Sets or queries the frequency bandwidth of the video filter for the spurious measurement in the RFID analysis (Option 21) and for the spectrum mask measurement in the IEEE802.11n (nx1) analysis (Option 29).

Syntax [:SENSe]:SPECTrum:BANDwidth]:BWIDth:VIDeo <value>
[:SENSe]:SPECTrum:BANDwidth]:BWIDth:VIDeo?

Arguments <value>::=<NRf> specifies the frequency bandwidth of the video filter.
Range: 0 to 1 GHz. The setting value may be limited by the sweep time setting.

Measurement Modes DEMRFID, DEMSWLAN

Examples :SENSe:SPECTrum:BANDwidth:VIDeo 100kHz
sets the frequency bandwidth of the video filter to 100 kHz.

Related Commands :INSTrument[:SELEct], [:SENSe]:RFID:MEASurement,
[:SENSe]:SWLAN:MEASurement

[[:SENSe]:SPEcTrum:BA NDwidth|:BWI Dth:VI Deo:STAtE(?]***Option 21 and 29***

Determines whether or not to use the video filter for the spurious measurement in the RFID analysis (Option 21) and for the spectrum mask measurement in the IEEE802.11n (nx1) analysis (Option 29).

Syntax [:SENSe]:SPEcTrum:BA NDwidth|:BWI Dth:VI Deo:STAtE
 { OFF | ON | 0 | 1 }

[:SENSe]:SPEcTrum:BA NDwidth|:BWI Dth:VI Deo:STAtE?

Arguments OFF or 0 disables the video filter.
 ON or 1 enables the video filter.

Measurement Modes DEMRFID, DEMSWLAN

Examples :SENSe:SPEcTrum:BA NDwidth:VI Deo:STAtE ON
 enables the video filter.

Related Commands :INSTrument[:SElect], [:SENSe]:RFID:MEASurement,
 [:SENSe]:SWLAN:MEASurement

[[:SENSe]:SPECTrum:BANDwidth]:BWIDth:VIDeo:SWEEp[:TIME](?)

Option 21 and 29

Sets or queries the sweep time for the video filter for the spurious measurement in the RFID analysis (Option 21) and for the spectrum mask measurement in the IEEE802.11n (nx1) analysis (Option 29).

Syntax [:SENSe]:SPECTrum:BANDwidth|:BWIDth:VIDeo:SWEEp[:TIME] <value>
[:SENSe]:SPECTrum:BANDwidth|:BWIDth:VIDeo:SWEEp[:TIME]?

Arguments <value>::=<NRf> specifies the sweep time. Range: 0 to 100 s.

Measurement Modes DEMRFID, DEMSWLAN

Examples :SENSe:SPECTrum:BANDwidth:VIDeo:SWEEp:TIME 100m
sets the sweep time to 100 ms.

Related Commands :INSTrument[:SElect], [:SENSe]:RFID:MEASurement,
[:SENSe]:SWLAN:MEASurement

[[:SENSe]:SPECTrum:FILTer:COEFFicient(?)

Sets or queries the roll-off rate of the RBW filter when you have selected either NYQuist (Nyquist filter) or RNYQuist (Root Nyquist filter) in the [:SENSe]:SPECTrum:FILTer:TYPE command.

Syntax [:SENSe]:SPECTrum:FILTer:COEFFicient <ratio>
 [:SENSe]:SPECTrum:FILTer:COEFFicient?

Arguments <ratio>::=<NRf> specifies the roll-off rate. Range: 0 to 1.

Measurement Modes All S/A modes except SARTIME and SAZRTIME

Examples :SENSe:SPECTrum:FILTer:COEFFicient 0.5
 sets the RBW filter roll-off rate to 0.5.

Related Commands [:SENSe]:SPECTrum:FILTer:TYPE

[[:SENSe]:SPECTrum:FILTer:TYPE(?)

Selects or queries the RBW filter.

Syntax [:SENSe]:SPECTrum:FILTer:TYPE { RECTangle | GAUSSian | NYQuist
 | RNYQuist }
 [:SENSe]:SPECTrum:FILTer:TYPE?

Arguments RECTangle selects the rectangular filter.
 GAUSSian selects the Gaussian filter.
 NYQuist selects the Nyquist filter (default).
 RNYQuist selects the Root Nyquist filter.

Measurement Modes All S/A modes except SARTIME and SAZRTIME

Examples :SENSe:SPECTrum:FILTer:TYPE NYQuist
 selects the Nyquist filter for RBW.

[:SENSe]:SPECtrum:FFT:ERESolution(?)

Determines whether to enable the extended resolution that eliminates the limit on the number of FFT points (it is normally limited internally).

Syntax [:SENSe]:SPECtrum:FFT:ERESolution { OFF | ON | 0 | 1 }

[:SENSe]:SPECtrum:FFT:ERESolution?

Arguments OFF or 0 disables the extended resolution. The number of FFT points is limited internally.

ON or 1 allows you to set the number of FFT points up to 65536. Use the [:SENSe]:SPECtrum:FFT:LENGth command to set the number.

NOTE. *It is recommended to keep the extended resolution off as its default condition.*

Measurement Modes All S/A modes except SARTIME and SAZRTIME

Examples :SENSe:SPECtrum:FFT:ERESolution ON
enables the extended resolution.

Related Commands [:SENSe]:SPECtrum:FFT:LENGth

[[:SENSe]:SPEctrum:FFT:LENGth(?)

Sets or queries the number of FFT points. This command is valid when [:SENSe]:SPEctrum:BANDwidth]:BWIDth:STATe is OFF.

Syntax [:SENSe]:SPEctrum:FFT:LENGth <value>

[:SENSe]:SPEctrum:FFT:LENGth?

Arguments <value>::=<NR1> sets the number of FFT points.
Range: 64 to 65536 in powers of 2.

Measurement Modes All S/A modes except SARTIME and SAZRTIME

Examples :SENSe:SPEctrum:FFT:LENGth 1024
sets the number of FFT points to 1024.

Related Commands [:SENSe]:SPEctrum:BANDwidth]:BWIDth:STATe

[[:SENSe]:SPEctrum:FFT:STARt(?)

Sets or queries the FFT start point between 1024-point overlapped FFTs.

NOTE. This command is valid when :INSTRument[:SElect] is set to SARTIME (Real Time S/A).

Syntax [:SENSe]:SPEctrum:FFT:STARt <value>

[:SENSe]:SPEctrum:FFT:STARt?

Arguments <value>::={ 64 | 128 | 256 | 512 | 1024 } selects the FFT start point between 1024-points overlapped FFTs with the number of data points.

Measurement Modes SARTIME

Examples :SENSe:SPEctrum:FFT:STARt 256
sets the FFT start point to 256 points.

[[:SENSe]:SPECTrum:FFT:WINDow[:TYPE](?)

Selects or queries the FFT window function. This command is valid when [:SENSe]:SPECTrum:BANDwidth[:BWIDth:STATe] is OFF.

Syntax [:SENSe]:SPECTrum:FFT:WINDow[:TYPE] { BH3A | BH3B | BH4A | BH4B | BLACKman | HAMMing | HANNing | PARZen | ROSenfield | WELCh | SLOBe | SCUBed | ST4T | FLATtop | RECT }

[:SENSe]:SPECTrum:FFT:WINDow[:TYPE]?

Arguments Table 2-96 shows the arguments and their meanings.

Table 2-96: FFT windows

Argument	FFT window
BH3A	Blackman-Harris 3A type
BH3B	Blackman-Harris 3B type
BH4A	Blackman-Harris 4A type
BH4B	Blackman-Harris 4B type
BLACKman	Blackman
HAMMing	Hamming
HANNing	Hanning
PARZen	Parzen
ROSenfield	Rosenfield
WELCh	Welch
SLOBe	Sine lobe
SCUBed	Sine cubed
ST4T	Sine to 4th
FLATtop	Flat top
RECT	Rectangular

Measurement Modes All S/A modes except SARTIME and SAZRTIME

Examples :SENSe:SPECTrum:FFT:WINDow:TYPE HAMMing
selects the Hamming window.

Related Commands [:SENSe]:SPECTrum:BANDwidth[:BWIDth:STATe]

[[:SENSe]:SPECTrum:FRAMe(?)]

Sets or queries the frame number of the spectrum frame to be measured in the Real Time S/A (real-time spectrum analysis) mode.

Syntax [:SENSe]:SPECTrum:FRAMe <number>

[:SENSe]:SPECTrum:FRAMe?

Arguments <number>::=<NR1> specifies the frame number. Range: -M to 0
(M: Block size set using the [:SENSe]:BSIZe command)

Measurement Modes SARTIME

Examples :SENSe:SPECTrum:FRAMe -5
sets the frame number to -5.

Related Commands [:SENSe]:BSIZe, [:SENSe]:SPECTrum:BLOCK

[:SENSe]:SPEctrum:MEASurement(?)

Selects and runs the measurement item in the S/A (spectrum analysis) mode. The query version of this command returns the current measurement item.

Syntax [:SENSe]:SPEctrum:MEASurement { OFF | CHPower | ACPower | OBWidth
| EBWidth | CNRatio | CFrequency | SPURious }
[:SENSe]:SPEctrum:MEASurement?

Arguments Table 2-97 shows the arguments and their meanings.

Table 2-97: S/A mode measurement items

Argument	Measurement item
OFF	Turns off the measurement.
CHPower	Channel power
ACPower	Adjacent channel leakage power (ACPR)
OBWidth	Occupied bandwidth (OBW)
EBWidth	Emission bandwidth (EBW)
CNRatio	Carrier-to-noise ratio (C/N)
CFrequency	Carrier frequency
SPURious	Spurious signal

Measurement Modes SANORMAL, SASGRAM, SARTIME, SAUL3G

Examples :SENSe:SPEctrum:MEASurement CHPower
runs the channel power measurement.

[[:SENSe]:SPECTrum:ZOOM:BLOCK(?)]

Sets or queries the number of the block to zoom in the Real-Time S/A with Zoom mode.

Syntax [:SENSe]:SPECTrum:ZOOM:BLOCK <value>

[:SENSe]:SPECTrum:ZOOM:BLOCK?

Arguments <number>::=<NR1> specifies the block number to zoom.
Zero represents the latest block.
Range: -M to 0 (M: Number of acquired blocks).

Measurement Modes SAZRTIME

Examples :SENSe:SPECTrum:ZOOM:BLOCK -5
sets the block number to -5.

[[:SENSe]:SPEcTrum:ZOOM:FREQuency:CENTer(?)

Sets or queries the center frequency of a zoomed area in the Real-Time S/A with Zoom mode.

Syntax [[:SENSe]:SPEcTrum:ZOOM:FREQuency:CENTer <value>

[[:SENSe]:SPEcTrum:ZOOM:FREQuency:CENTer?

Arguments <value>::=<NRf> specifies the center frequency of a zoomed area. The setting value must be within the measurement frequency range.

Measurement Modes SAZRTIME

Examples :SENSe:SPEcTrum:ZOOM:FREQuency:CENTer 1.75GHz
sets the center frequency of the zoomed area to 1.75 GHz.

[[:SENSe]:SPEcTrum:ZOOM:FREQuency:WIDTh(?)

Sets or queries the frequency width of a zoomed area in the Real-Time S/A with Zoom mode.

Syntax [[:SENSe]:SPEcTrum:ZOOM:FREQuency:WIDTh <value>

[[:SENSe]:SPEcTrum:ZOOM:FREQuency:WIDTh?

Arguments <value>::=<NRf> specifies the frequency width of a zoomed area. The setting value must be within the measurement frequency range.

Measurement Modes SAZRTIME

Examples :SENSe:SPEcTrum:ZOOM:FREQuency:WIDTh 500kHz
sets the frequency width of the zoomed area to 500 kHz.

[[:SENSe]:SPEctrum:ZOOM:LENGth(?)

Sets or queries the time length of a zoomed area in the Real-Time S/A with Zoom mode.

Syntax [:SENSe]:SPEctrum:ZOOM:LENGth <value>
 [:SENSe]:SPEctrum:ZOOM:LENGth?

Arguments <value>::=<NR1> specifies the range of a zoomed area by the number of data points.
Range: The smaller of 1 to [1024 × (block size)] or [81920 - 512 = 81408].
To set the block size, use the [:SENSe]:BSIZe command.

Measurement Modes SAZRTIME

Examples :SENSe:SPEctrum:ZOOM:LENGth 1000
 sets the measurement range to 1000 points.

Related Commands [:SENSe]:BSIZe

[[:SENSe]:SPEctrum:ZOOM:OFFSet(?)

Sets or queries the starting point of a zoomed area in the Real-Time S/A with Zoom mode.

Syntax [:SENSe]:SPEctrum:ZOOM:OFFSet <value>
 [:SENSe]:SPEctrum:ZOOM:OFFSet?

Arguments <value>::=<NRf> specifies the starting point of a zoomed area by considering the trigger output point as the reference. Range: 0 to 1024 × (Block size) -1.
To set the block size, use the [:SENSe]:BSIZe command.

Measurement Modes SAZRTIME

Examples :SENSe:SPEctrum:ZOOM:OFFSet 500
 sets the starting point of a zoomed area to point 500.

Related Commands [:SENSe]:BSIZe

[:SENSe]:SPURious Subgroup

The [:SENSe]:SPURious commands set up the conditions related to the spurious signal measurement.

Command Tree	Header	Parameter
	[SENSe]	
	:SPURious	
	[:THReshold]	
	:EXCursion	<numeric_value>
	:IGNore	<numeric_value>
	:SIGNa1	<numeric_value>
	:SPURious	<numeric_value>

Prerequisites for Use

To use a command from this group, you must have run at least the following two commands:

1. Run the following command to set the measurement mode to S/A:

```
:INSTrument[:SElect] { SANORMAL | SASGRAM | SARTIME }
```
2. Run one of the following commands to start the spurious signal measurement:
 - To start the measurement with the default settings:

```
:CONFIgure:SPECTrum:SPURious
```
 - To start the measurement without modifying the current settings:

```
[:SENSe]:SPECTrum:MEASurement SPURious
```

[[:SENSe]:SPURious[:THReshold]:EXCursion(?)]

Sets or queries the excursion level to determine if the signal is spurious in the spurious signal measurement (see Figure 2-25).

Syntax [:SENSe]:SPURious[:THReshold]:EXCursion <level>
[:SENSe]:SPURious[:THReshold]:EXCursion?

Arguments <level>::=<NRf> specifies the excursion level. If the signal exceeds the excursion level and meets the other threshold requirements that you set, it is considered to be spurious. Range: 0 to 30 dB (default: 3 dB)

Measurement Modes SANORMAL, SASGRAM, SARTIME

Examples :SENSe:SPURious:THReshold:EXCursion 5
sets the excursion level to 5 dB.

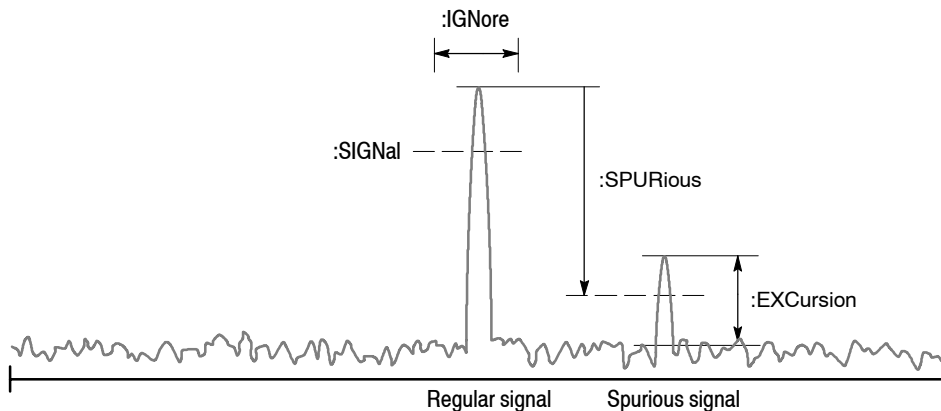

NOTE: Command header [:SENSe]:SPURious[:THReshold] is omitted here.

Figure 2-25: Setting up the spurious signal measurement

[[:SENSe]:SPURious[:THReshold]:IGNore(?)

Sets or queries the range not to detect spurious signals around the carrier peak signal to avoid errors (see Figure 2-25).

Syntax [[:SENSe]:SPURious[:THReshold]:IGNore <value>

[[:SENSe]:SPURious[:THReshold]:IGNore?

Arguments <value>::=<NRf> specifies the range not to detect spurious around the carrier peak signal. Range: 0 to Span/2 [Hz].

Measurement Modes SANORMAL, SASGRAM, SARTIME

Examples :SENSe:SPURious:THReshold:IGNore 1MHz
sets the range not to detect spurious to 1 MHz.

[[:SENSe]:SPURious[:THReshold]:SIGNal(?)

Sets or queries the threshold level to determine if the signal is the carrier in the spurious signal measurement (see Figure 2-25).

Syntax [[:SENSe]:SPURious[:THReshold]:SIGNal <level>

[[:SENSe]:SPURious[:THReshold]:SIGNal?

Arguments <level>::=<NR1> specifies the signal criterion level. If the signal exceeds the level, it is decided to be the carrier. Range: -100 to +30 dBm

Measurement Modes SANORMAL, SASGRAM, SARTIME

Examples :SENSe:SPURious:THReshold:SIGNal -30
sets the carrier criterion level to -30 dBm.

[[:SENSe]:SPURious[:THReshold]:SPURious(?)

Sets or queries the threshold level to determine if the signal is spurious in the spurious signal measurement (see Figure 2-25).

Syntax [:SENSe]:SPURious[:THReshold]:SPURious <level>

 [:SENSe]:SPURious[:THReshold]:SPURious?

Arguments <level>: :=<NR1> specifies the spurious criterion level relative to the carrier peak. If the signal exceeds the level and meets the other threshold requirements that you set, it is considered to be spurious. Range: -90 to -30 dB.

Measurement Modes SANORMAL, SASGRAM, SARTIME

Examples :SENSe:SPURious:THReshold:SPURious -50
 sets the spurious criterion level to -50 dB relative to the carrier peak.

[:SENSe]:TRANsient Subgroup

The [:SENSe]:TRANsient commands set up the conditions related to the time characteristic analysis. The time characteristic analysis includes IQ level vs. time, power vs. time, and frequency vs. time measurements.

NOTE. To use a command from this group, you must have selected TIMTRAN (time characteristic analysis) in the :INSTRument[:SELEct] command.

Command Tree	Header	Parameter
	[:SENSe]	
	:TRANsient	
	:BLOCk	<numeric_value>
	[:IMMediate]	
	:ITEM	IQVTime PVTime FVTime
	:LENGth	<numeric_value>
	:OFFSet	<numeric_value>

For the commands defining the analysis range, see the figure below. The analysis range is shown by a green line in the overview.

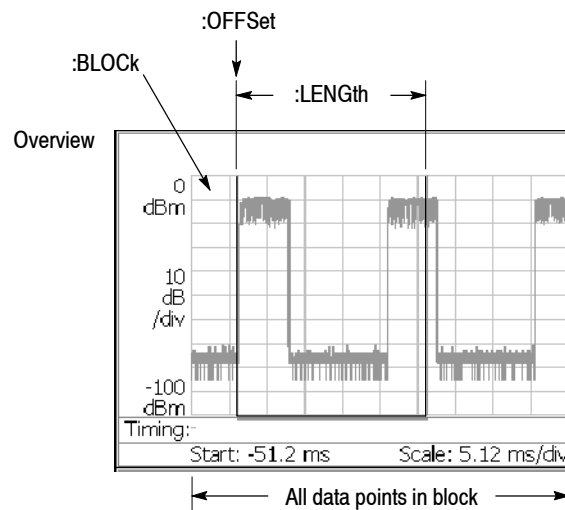

NOTE: Command header [:SENSe]:TRANsient is omitted here.

Figure 2-26: Defining the analysis range

[[:SENSe]:TRANsient:BLOCK(?)]

Sets or queries the number of the block to measure in the time characteristic analysis.

Syntax [:SENSe]:TRANsient:BLOCK <value>

[:SENSe]:TRANsient:BLOCK?

Arguments <value>::=<NR1> specifies the block number. Zero represents the latest block.
Range: -M to 0 (M: Number of acquired blocks)

Measurement Modes TIMTRAN

Examples :SENSe:TRANsient:BLOCK -5
sets the block number to -5.

[[:SENSe]:TRANsient[:IMMediate] (No Query Form)]

Runs the time characteristic analysis calculation for the acquired data.
To select the measurement item, use the [:SENSe]:TRANsient:ITEM command.
To acquire data, use the :INITiate command.

Syntax [:SENSe]:TRANsient[:IMMediate]

Arguments None

Measurement Modes TIMTRAN

Examples :SENSe:TRANsient:IMMediate
runs the time characteristic analysis calculation.

Related Commands :INITiate, [:SENSe]:TRANsient:ITEM

[[:SENSe]:TRANsient:ITEM(?)]

Selects or queries the measurement item in the time characteristic analysis.

Syntax [:SENSe]:TRANsient:ITEM { OFF | IQVTime | PVTTime | FVTTime }
 [:SENSe]:TRANsient:ITEM?

Arguments OFF turns off measurement.
 IQVTime selects the IQ level vs. time measurement.
 PVTTime selects the power vs. time measurement.
 FVTTime selects the frequency vs. time measurement.

Measurement Modes TIMTRAN

Examples :SENSe:TRANsient:ITEM IQVTime
 selects the IQ level vs. time measurement.

[[:SENSe]:TRANsient:LENGth(?)]

Sets or queries the range for the time characteristic analysis.

Syntax [:SENSe]:TRANsient:LENGth <value>
 [:SENSe]:TRANsient:LENGth?

Arguments <value>::=<NR1> specifies the analysis range by the number of data points.
 Range: 1 to 1024 × Block size (Block size ≤ 500).
 To set the block size, use the [:SENSe]:BSIZe command.

Measurement Modes TIMTRAN

Examples :SENSe:TRANsient:LENGth 1000
 sets the analysis range to 1000 points.

Related Commands [:SENSe]:BSIZe

[[:SENSe]:TRANsient:OFFSet(?)

Sets or queries the measurement start position in the time characteristic analysis.

Syntax [:SENSe]:TRANsient:OFFSet <value>
 [:SENSe]:TRANsient:OFFSet?

Arguments <value>::=<NR1> defines the measurement start position by the number of points. Range: 0 to 1024 × (Block size). To set the block size, use the [:SENSe]:BSIZe command.

Measurement Modes TIMTRAN

Examples :SENSe:TRANsient:OFFSet 500
 sets the measurement start position to point 500.

Related Commands [:SENSe]:BSIZe

:SENSe Commands (Option)

This section describes the :SENSe commands for optional analysis software as shown in Table 2-98.

Table 2-98: :SENSe command subgroups (Option)

Command header	Function	Refer to:
Option 21 Advanced measurement suite related		
[:SENSE]:DDEMod	Sets up the digital modulation analysis.	page 2-1122
[:SENSE]:RFID	Sets up the RFID analysis.	page 2-1141
[:SENSE]:SSource	Sets up the signal source analysis.	page 2-1170
Option 23 W-CDMA uplink related		
[:SENSE]:AC3Gpp	Sets up the W-CDMA ACLR measurement.	page 2-1195
[:SENSE]:UL3Gpp	Sets up the W-CDMA downlink analysis.	page 2-1197
Option 24 GSM/EDGE related		
[:SENSE]:GSMedge	Sets up the GSM/EDGE analysis.	page 2-1205
Option 25 cdma2000 related		
[:SENSe]:FLCDMA2K]:RLCDMA2K	Sets up conditions for the cdma2000 analysis.	page 2-1219
[:SENSe]:FLCDMA2K]:RLCDMA2K:ACPower	Sets up the ACPR measurement.	page 2-1226
[:SENSe]:FLCDMA2K]:RLCDMA2K:CCDF	Sets up the CCDF measurement.	page 2-1230
[:SENSe]:FLCDMA2K]:RLCDMA2K:CDPower	Sets up the code domain power measurement.	page 2-1232
[:SENSe]:FLCDMA2K]:RLCDMA2K:CHPower	Sets up the channel power measurement.	page 2-1241
[:SENSe]:FLCDMA2K]:RLCDMA2K:IM	Sets up the intermodulation measurement.	page 2-1245
[:SENSe]:FLCDMA2K]:RLCDMA2K:MACCuracy	Sets up the modulation accuracy measurement.	page 2-1250
[:SENSe]:FLCDMA2K]:RLCDMA2K:OBWidth	Sets up the occupied bandwidth measurement.	page 2-1261
[:SENSe]:FLCDMA2K]:RLCDMA2K:PCCHannel	Sets up the pilot-to-code channel measurement.	page 2-1263
[:SENSe]:RLCDMA2K:PVTime	Sets up the gated output power measurement.	page 2-1271
[:SENSe]:FLCDMA2K]:RLCDMA2K:SEMAsk	Sets up the spectrum emission mask measurement.	page 2-1277
Option 26 1xEV-DO related		
[:SENSe]:FL1XEVD0]:RL1XEVD0	Sets up conditions for the 1xEV-DO analysis.	page 2-1284
[:SENSe]:FL1XEVD0]:RL1XEVD0:ACPower	Sets up the ACPR measurement.	page 2-1291
[:SENSe]:FL1XEVD0]:RL1XEVD0:CCDF	Sets up the CCDF measurement.	page 2-1295
[:SENSe]:FL1XEVD0]:RL1XEVD0:CDPower	Sets up the code domain power measurement.	page 2-1297
[:SENSe]:FL1XEVD0]:RL1XEVD0:CHPower	Sets up the channel power measurement.	page 2-1306
[:SENSe]:FL1XEVD0]:RL1XEVD0:IM	Sets up the intermodulation measurement.	page 2-1310

Table 2-98: :SENSe command subgroups (Option) (Cont.)

Command header	Function	Refer to:
[:SENSe]:FL1XEVD0 :RL1XEVD0:MACCuracy	Sets up the modulation accuracy measurement.	page 2-1315
[:SENSe]:FL1XEVD0 :RL1XEVD0:OBWidth	Sets up the occupied bandwidth measurement.	page 2-1327
[:SENSe]:FL1XEVD0 :RL1XEVD0:PCCHannel	Sets up the pilot-to-code channel measurement.	page 2-1329
[:SENSe]:RL1XEVD0:PVTime	Sets up the gated output power measurement.	page 2-1338
[:SENSe]:FL1XEVD0 :RL1XEVD0:SEMAsk	Sets up the spectrum emission mask measurement.	page 2-1344
Option 27 3GPP-R5 related		
[:SENSe]:DLR5_3GPP	Sets up the modulation analysis for 3GPP-R5 downlink.	page 2-1355
[:SENSe]:SADLR5_3GPP :SAULR5_3GPP:ACLR	Sets up the ACLR measurement.	page 2-1366
[:SENSe]:SADLR5_3GPP :SAULR5_3GPP:CFRequency	Sets up the carrier frequency measurement.	page 2-1371
[:SENSe]:SADLR5_3GPP :SAULR5_3GPP:CHPower	Sets up the channel power measurement.	page 2-1373
[:SENSe]:SADLR5_3GPP :SAULR5_3GPP:EBWidth	Sets up the EBW measurement.	page 2-1376
[:SENSe]:SADLR5_3GPP:MCAClr	Sets up the multi-carrier ACLR measurement.	page 2-1378
[:SENSe]:SADLR5_3GPP :SAULR5_3GPP:OBWidth	Sets up the OBW measurement.	page 2-1383
[:SENSe]:SADLR5_3GPP :SAULR5_3GPP:SEMAsk	Sets up the spectrum emission mask measurement.	page 2-1385
[:SENSe]:ULR5_3GPP	Sets up the modulation analysis for 3GPP-R5 uplink.	page 2-1392
Option 28 TD-SCDMA analysis related		
[:SENSe]:TD_SCDMA	Sets up conditions for the TD-SCDMA analysis.	page 2-1403
[:SENSe]:TD_SCDMA:ACLR	Sets up the ACLR measurement.	page 2-1407
[:SENSe]:TD_SCDMA:ACQuisition	Sets up the acquisition conditions.	page 2-1409
[:SENSe]:TD_SCDMA:ANALysis	Sets up the analysis conditions.	page 2-1412
[:SENSe]:TD_SCDMA:CHPower	Sets up the channel power measurement.	page 2-1419
[:SENSe]:TD_SCDMA:IM	Sets up the intermodulation measurement.	page 2-1422
[:SENSe]:TD_SCDMA:MACCuracy	Sets up the modulation accuracy measurement.	page 2-1426
[:SENSe]:TD_SCDMA:MODulation	Sets up the modulation conditions.	page 2-1431
[:SENSe]:TD_SCDMA:OBWidth	Sets up the OBW measurement.	page 2-1436
[:SENSe]:TD_SCDMA:SElect	Sets up the select conditions	page 2-1439
[:SENSe]:TD_SCDMA:SEMAsk	Sets up the spectrum emission mask measurement.	page 2-1443
[:SENSe]:TD_SCDMA:SPECTrum	Sets up the spectrum conditions.	page 2-1450
[:SENSe]:TD_SCDMA:STABLE	Sets up conditions for the symbol table.	page 2-1452
[:SENSe]:TD_SCDMA:TOOMask	Sets up the transmit on/off mask measurement.	page 2-1454
Option 29 WLAN related		
[:SENSe]:M2WLAN	Sets up the IEEE802.11n MIMO analysis.	page 2-1457
[:SENSe]:SWLAN	Sets up the IEEE802.11n (nx1) analysis.	page 2-1467
[:SENSe]:WLAN	Sets up the IEEE802.11a/b/g analysis.	page 2-1479

Table 2-98: :SENSE command subgroups (Option) (Cont.)

Command header	Function	Refer to:
Option 40 3GPP-R6 related		
[:SENSE]:DLR5_3GPP	Sets up the modulation analysis for 3GPP-R6 downlink.	page 2-1490
[:SENSE]:ULR5_3GPP	Sets up the modulation analysis for 3GPP-R6 uplink.	page 2-1504

[[:SENSe]:DDEMod Subgroup**Digital Modulation Analysis, Option 21 Only**

The [[:SENSe]:DDEMod commands set up the conditions related to the digital modulation analysis.

NOTE. To use a command from this group, you must have selected DEMDDEM (digital modulation analysis) in the :INSTrument[:SELEct] command.

Command Tree	Header	Parameter
	[[:SENSe]	
	:DDEMod	
	:BLOCK	<numeric_value>
	:CARRier	
	:OFFSet	<frequency>
	:SEARch	<boolean>
	:DECode	NRZ MANChester MILLer
	:FDEVIation	<numeric_value>
	:AUTO	<boolean>
	:FILTer	
	:ALPHa	<numeric_value>
	:MEASurement	OFF RR̄Cosine
	:REFerence	OFF RCOSine GAUSSian HSINe
	:FORMat	BPSK QPSK PS8P Q16P Q32P Q64P Q128P Q256P GMSK GFSK DQPSk OQPSk ASK FSK C4FM
	[:IMMediate]	
	:LENGth	<numeric_value>
	:MDEPth	<numeric_value>
	:AUTO	<boolean>
	:NLINearity	
	:COEFFicient	<numeric_value>
	:HDIVision	<numeric_value>
	:LSRegion	
	[:SET]	<numeric_value>
	:UNIT	RELative ABSolute
	:OFFSet	<numeric_value>
	:PRESet	OFF ZOQPSk NADC PDC PHS TETRa GSM CDPD BLUetooth C4FM
	:SRATE	<numeric_value>

For the commands defining the analysis range, see the figure below. The analysis range is shown as a green line in the overview.

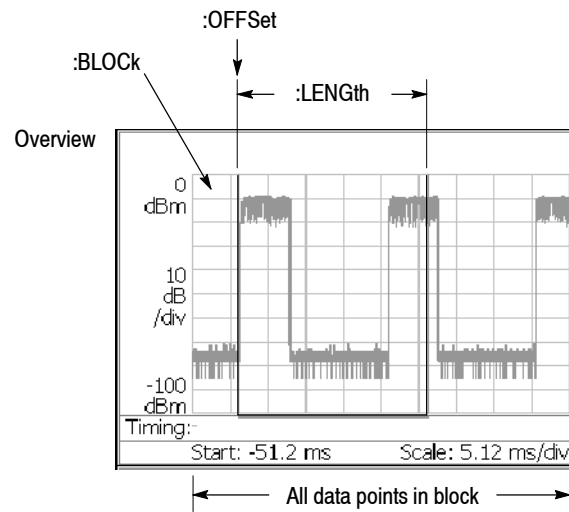

NOTE: Command header [:SENSe]:DDEMod is omitted here.

Figure 2-27: Defining the analysis range

[[:SENSe]:DDEMod:BLOCK(?)]

Sets or queries the number of the block to measure in the digital modulation analysis (see Figure 2-27).

Syntax [[:SENSe]:DDEMod:BLOCK <number>

[[:SENSe]:DDEMod:BLOCK?

Arguments <number>::=<NR1> specifies the block number. Zero represents the latest block.
Range: -M to 0 (M: Number of acquired blocks)

Measurement Modes DEMDDEM

Examples :SENSe:DDEMod:BLOCK -5
sets the block number to -5.

[[:SENSe]:DDEMod:CARRIER:OFFSET(?)]

Sets or queries the carrier frequency offset in the digital modulation analysis when [[:SENSe]:DDEMod:CARRIER:SEARCH] is set to OFF.

Syntax [[:SENSe]:DDEMod:CARRIER:OFFSET <freq>

[[:SENSe]:DDEMod:CARRIER:OFFSET?

Arguments <freq>::=<NR1> is the carrier frequency offset.
Range: -Fs to +Fs (Fs: Span)

Measurement Modes DEMDDEM

Examples :SENSe:DDEMod:CARRIER:OFFSET 10MHz
sets the carrier frequency offset to 10 MHz.

Related Commands [[:SENSe]:DDEMod:CARRIER:SEARCH]

[[:SENSE]:DDEMod:CARRier:SEARch(?)

Selects or queries whether to detect the carrier automatically in the digital modulation analysis.

Syntax [[:SENSE]:DDEMod:CARRier:SEARch { OFF | ON | 0 | 1 }

[[:SENSE]:DDEMod:CARRier:SEARch?

Arguments OFF or 0 specifies that the carrier is not detected automatically. To set the carrier frequency offset, use the [[:SENSE]:DDEMod:CARRier:OFFSet command.

ON or 1 specifies that the carrier is detected automatically.

Measurement Modes DEMDDEM

Examples :SENSE:DDEMod:CARRier:SEARch ON
specifies that the carrier is detected automatically.

Related Commands [[:SENSE]:DDEMod:CARRier:OFFSet

[:SENSe]:DDEMod:DECode(?)

Selects or queries the method that is used to decode the data bits from each symbol choice.

NOTE. This command is valid when [:SENSe]:DDEMod:FORMat is ASK, FSK or GFSK.

Syntax [:SENSe]:DDEMod:DECode { NRZ | MANChester | MILLer }
[:SENSe]:DDEMod:DECode?

Arguments NRZ selects the NRZ (Non-Return to Zero) decoding.
MANChecter selects the Manchester decoding.
MILLer selects the Miller decoding.

Measurement Modes DEMDDEM

Examples :SENSe:DDEMod:DECode NRZ
selects the NRZ decoding.

Related Commands [:SENSe]:DDEMod:FORMat

[:SENSe]:DDEMod:FDEVIation(?)

Sets or queries the frequency deviation to separate two states of an FSK or GFSK signal. This command is valid when [:SENSe]:DDEMod:FORMat is set to FSK or GFSK and [:SENSe]:DDEMod:FDEVIation:AUTO is set to OFF.

Syntax [:SENSe]:DDEMod:FDEVIation <value>
 [:SENSe]:DDEMod:FDEVIation?

Arguments <value>::=<NRf> sets the frequency deviation. Range: 0 to Span/2 Hz

Measurement Modes DEMDDEM

Examples :SENSe:DDEMod:FDEVIation 1MHz
 sets the frequency deviation to 1 MHz.

Related Commands [:SENSe]:DDEMod:FDEVIation:AUTO, [:SENSe]:DDEMod:FORMat

[[:SENSe]:DDEMod:FDEVIation:AUTO(?)]

Determines whether to detect automatically or set manually the frequency deviation used to distinguish between the two states of an FSK or GFSK signal. This command is valid when [[:SENSe]:DDEMod:FORMat] is set to FSK or GFSK.

Syntax [[:SENSe]:DDEMod:FDEVIation:AUTO { OFF | ON | 0 | 1 }
[[:SENSe]:DDEMod:FDEVIation:AUTO?

Arguments ON or 1 automatically calculates the frequency deviation for the analysis range and displays the value in the Frequency Deviation side key (default).
OFF or 0 sets the frequency deviation using the [[:SENSe]:DDEMod:FDEVIation] command.

Measurement Modes DEMDDEM

Examples :SENSe:DDEMod:FDEVIation:AUTO ON
automatically calculates the frequency deviation.

Related Commands [[:SENSe]:DDEMod:FDEVIation], [[:SENSe]:DDEMod:FORMat]

[[:SENSe]:DDEMod:FILTer:ALPHA(?)]

Sets or queries the filter factor (α/BT) in the digital modulation analysis.

Syntax [[:SENSe]:DDEMod:FILTer:ALPHA <value>
[[:SENSe]:DDEMod:FILTer:ALPHA?

Arguments <value>::=<NRf> is the filter factor. Range: 0.0001 to 1.

Measurement Modes DEMDDEM

Examples :SENSe:DDEMod:FILTer:ALPHA 0.5
sets the filter factor to 0.5.

[[:SENSE]:DDEMod:FILTer:MEASurement(?)]

Selects or queries the measurement filter in the digital modulation analysis.

Syntax [[:SENSE]:DDEMod:FILTer:MEASurement { OFF | RRCosine }
[[:SENSE]:DDEMod:FILTer:MEASurement?

Arguments OFF specifies that no filter is used.
RRCosine selects the Root Raised Cosine filter.

Measurement Modes DEMDDEM

Examples :SENSE:DDEMod:FILTer:MEASurement RRCosine
selects the Root Raised Cosine filter as the measurement filter.

[[:SENSE]:DDEMod:FILTer:REFerence(?)]

Selects or queries the reference filter in the digital modulation analysis.

Syntax [[:SENSE]:DDEMod:FILTer:REFerence
{ OFF | RCOSine | GAUSSian | HSINe }
[[:SENSE]:DDEMod:FILTer:REFerence?

Arguments OFF specifies that no filter is used.
RCOSine selects the Raised Cosine filter.
GAUSSian selects the Gaussian filter.
HSINe selects the half sine filter.

Measurement Modes DEMDDEM

Examples :SENSE:DDEMod:FILTer:REFerence RCOSine
selects the Raised Cosine filter as the reference filter.

[:SENSe]:DDEMod:FORMat(?)

Selects or queries the modulation system in the digital modulation analysis.

Syntax [:SENSe]:DDEMod:FORMat { BPSK | QPSK | PS8P | Q16P | Q32P | Q64P
| Q128P | Q256P | GMSK | GFSK | DQPSk | OQPSk | ASK | FSK
| C4FM }

[:SENSe]:DDEMod:FORMat?

Arguments Table 2-99 lists the arguments and corresponding modulations.

Table 2-99: Modulation selections

Argument	Modulation
BPSK	BPSK
QPSK	QPSK
PS8P	8PSK
Q16P	16QAM
Q32P	32QAM
Q64P	64QAM
Q128P	128QAM
Q256P	256QAM
GMSK	GMSK
GFSK	GFSK
DQPSk	1/4 π QPSK
OQPSk	OQPSK
ASK	ASK
FSK	FSK
C4FM	P25 (Project 25) C4FM

Measurement Modes DEMDDEM

Examples :SENSe:DDEMod:FORMat Q128P
selects the 128QAM modulation system.

[:SENSE]:DDEMod[:IMMEDIATE] (No Query Form)

Runs the digital demodulation calculation for the acquired data. To select the measurement item, use the :DISPLAY:DDEMod:MView:FORMAT command. To acquire data, use the :INITiate command.

Syntax [:SENSE]:DDEMod[:IMMEDIATE]

Arguments None

Measurement Modes DEMDDDEM

Examples :SENSE:DDEMod:IMMEDIATE
runs the digital demodulation calculation.

Related Commands :INITiate, :DISPLAY:DDEMod:MView:FORMAT

[[:SENSe]:DDEMod:LENGth(?)

Sets or queries the range for the digital modulation analysis (see Figure 2-27).

NOTE. The `[[:SENSe]:DDEMod:LENGth?` query may return a value smaller than the default (1536) since the value is limited by the number of data points in the block.

Syntax `[[:SENSe]:DDEMod:LENGth <value>`

`[[:SENSe]:DDEMod:LENGth?`

Arguments `<value>::=<NR1>` specifies the analysis range by the number of data points. Range: 1 to $[1024 \times (\text{block size})]$ or $[81920 - 512 = 81408]$ whichever smaller. To set the block size, use the `[[:SENSe]:BSIZe` command.

Measurement Modes DEMDDEM

Examples `:SENSe:DDEMod:LENGth 1000`
sets the measurement range to 1000 points.

Related Commands `[[:SENSe]:BSIZe`

[:SENSe]:DDEMod:MDEPth(?)

Sets or queries the modulation depth to separate two states of an ASK signal. This command is valid when [:SENSe]:DDEMod:FORMat is set to ASK and [:SENSe]:DDEMod:MDEPth:AUTO is set to OFF.

Syntax [:SENSe]:DDEMod:MDEPth <value>
 [:SENSe]:DDEMod:MDEPth?

Arguments <value>::=<NRf> specifies the depth of modulation. Range: 0 to 100%

Measurement Modes DEMDDEM

Examples :SENSe:DDEMod:MDEPth 20
 sets the modulation depth to 20%.

Related Commands [:SENSe]:DDEMod:FORMat, [:SENSe]:DDEMod:MDEPth:AUTO

[[:SENSe]:DDEMod:MDEPth:AUTO(?)]

Determines whether to detect automatically or set manually the modulation depth used to distinguish between the two states of an ASK signal. This command is valid when [:SENSe]:DDEMod:FORMat is set to ASK.

Syntax [:SENSe]:DDEMod:MDEPth:AUTO { OFF | ON | 0 | 1 }
 [:SENSe]:DDEMod:MDEPth:AUTO?

Arguments ON or 1 automatically calculates the modulation depth for the analysis range and displays the value in the Modulation Depth side key (default).

OFF or 0 sets the modulation depth using the [:SENSe]:DDEMod:MDEPth command.

Measurement Modes DEMDDEM

Examples :SENSe:DDEMod:MDEPth:AUTO ON
 automatically calculates the modulation depth.

Related Commands [:SENSe]:DDEMod:FORMat, [:SENSe]:DDEMod:MDEPth

[[:SENSE]:DDEMod:NLINearity:COEFFicient(?)]

Sets or queries the maximum order of the best-fit curve polynomial in the AM/AM or AM/PM measurement. This command is valid when :DISPlay:DDEMod:MVIew:FORMat is set to AMAM, AMPM, DAMam or DAMPm.

Syntax [:SENSE]:DDEMod:NLINearity:COEFFicient <number>
 [:SENSE]:DDEMod:NLINearity:COEFFicient?

Arguments <number>::=<NR1> specifies the maximum order of the best-fit curve polynomial. Range: 0 to 15 (the default is 8)

Measurement Modes DEMDDDEM

Examples :SENSE:DDEMod:NLINearity:COEFFicient 15
 sets the maximum order to 15.

Related Commands :DISPlay:DDEMod:MVIew:FORMat

[[:SENSE]:DDEMod:NLINearity:HDIVision(?)]

Sets or queries the horizontal interval between display points for the CCDF or PDF measurement in the digitald modulation analysis. This command is valid when :DISPlay:DDEMod:MVIew:FORMat is set to CCDF or PDF.

Syntax [:SENSE]:DDEMod:NLINearity:HDIVision <value>
 [:SENSE]:DDEMod:NLINearity:HDIVision?

Arguments <value>::=<NRf> specifies the horizontal interval between display points. Range: 0.01 to 1 dB (the default is 0.1 dB)

Measurement Modes DEMDDDEM

Examples :SENSE:DDEMod:NLINearity:HDIVision 0.2
 sets the horizontal interval between display points to 0.2 dB.

Related Commands :DISPlay:DDEMod:MVIew:FORMat

[[:SENSe]:DDEMod:NLINearity:LSRegion[:SET](?)

Sets or queries the linear signal region (a region supposed to have an ideal characteristic) in the AM/AM and AM/PM measurements. This command is valid when :DISPlay:DDEMod:MView:FORMat is set to AMAM, AMPM, DAMam or DAMPm.

Syntax [:SENSe]:DDEMod:NLINearity:LSRegion[:SET] <value>
[:SENSe]:DDEMod:NLINearity:LSRegion[:SET]?

Arguments <value>::=<NRf> specifies the linear signal region.
Range: -100 to 50 dB or dBm.

The unit is dB when [:SENSe]:DDEMod:NLINearity:LSRegion:UNIT is set to RELative, and dBm when ABSolute.

Measurement Modes DEMDDDEM

Examples :SENSe:DDEMod:NLINearity:LSRegion:SET -10
sets the linear signal region to -10 dB (or dBm).

Related Commands :DISPlay:DDEMod:MView:FORMat,
[:SENSe]:DDEMod:NLINearity:LSRegion:UNIT

[[:SENSe]:DDEMod:NLINearity:LSRegion:UNIT(?)]

Selects or queries the unit to set the linear signal region in the AM/AM and AM/PM measurements. This command is valid when :DISPlay:DDEMod:MView:FORMat is set to AMAM, AMPM, DAMam or DAMPm. Use the [:SENSe]:DDEMod:NLINearity:LSRegion[:SET] command to set the region.

Syntax [:SENSe]:DDEMod:NLINearity:LSRegion:UNIT { RELative | ABSolute }
[:SENSe]:DDEMod:NLINearity:LSRegion:UNIT?

Arguments RELative specifies the linear signal region in dB with a value relative to the maximum power measured in the analysis range (default).

ABSolute specifies the linear signal region with an absolute power in dBm.

Measurement Modes DEMDDEM

Examples :SENSe:DDEMod:NLINearity:LSRegion:UNIT RELative
specifies the linear signal region in dB.

Related Commands :DISPlay:DDEMod:MView:FORMat,
[:SENSe]:DDEMod:NLINearity:LSRegion[:SET]

[[:SENSe]:DDEMod:OFFSet(?)]

Sets or queries the measurement start position in the digital modulation analysis (see Figure 2-27).

NOTE. The `[[:SENSe]:DDEMod:OFFSet?` query may return a value greater than the default (0) since the value is limited by the trigger position in the block.

Syntax `[[:SENSe]:DDEMod:OFFSet <value>`

`[[:SENSe]:DDEMod:OFFSet?`

Arguments `<value>::=<NR1>` defines the measurement start position by the number of data points. Range: 0 to $1024 \times (\text{Block size}) - 1$.
To set the block size, use the `[[:SENSe]:BSIZE` command.

Measurement Modes DEMDDEM

Examples `:SENSe:DDEMod:OFFSet 500`
sets the measurement start position to point 500.

Related Commands `[[:SENSe]:BSIZE`

[[:SENSe]:DDEMod:PRESet(?)]

Selects or queries the communication standard in the digital modulation analysis. The analyzer is configured in accordance with the selected standard.

Syntax [[:SENSe]:DDEMod:PRESet { OFF | ZOQPsk | NADC | PDC | PHS | TETRa | GSM | CDPD | BLUetooth | C4FM }
[[:SENSe]:DDEMod:PRESet?

Arguments Table 2-100 lists the arguments and corresponding communication standards.

Table 2-100: Communication standard selections

Argument	Communication standard
OFF	No standard is selected.
NADC	NADC
ZOQPsk	IEEE802.15.4/OQPSK
PDC	PDC
PHS	PHS
TETRa	TETRA
GSM	GSM
CDPD	CDPD
BLUetooth	Bluetooth
C4FM	P25 (Project 25) C4FM

Measurement Modes DEMDDEM

Examples :SENSe:DDEMod:PRESet PDC
selects PDC to configure the analyzer for the standard.

[[:SENSe]:DDEMod:SRATe(?)]

Sets or queries the symbol rate in the digital modulation analysis.

Syntax [:SENSe]:DDEMod:SRATe <value>
 [:SENSe]:DDEMod:SRATe?

Arguments <value>::=<NRf> specifies the symbol rate.
 Range: 1 to 32 Msps (symbols per second)

NOTE. Do not include the unit in the argument of this command. For example, if you want to specify 21 kps for the symbol rate, use “21.0E3”, “21000”, or another equivalent representation.

Measurement Modes DEMDDDEM

Examples :SENSe:DDEMod:SRATe 21.0E3
 sets the symbol rate to 21 kps.

[[:SENSE]:RFID Subgroup**RFID Analysis, Option 21 Only**

The [[:SENSE]:RFID commands set up the conditions related to the RFID analysis.

NOTE. To use a command from this group, you must have selected DEMRFID (RFID analysis) in the :INSTRUMENT[:SELEct] command.

Command Tree	Header	Parameter
	[[:SENSE]	
	:RFID	
	:ACPower	
	:BANDwidth :BWIDth	
	:ACHannel	<numeric_value>
	:INTEgration	<numeric_value>
	:CSPacing	<numeric_value>
	:FILTer	
	:COEfficient	<numeric_value>
	:TYPE	RECTangle GAUSSian NYQuist RNYQuist
	:BLOCk	<numeric_value>
	:CARRier	
	:BANDwidth :BWIDth	
	:INTEgration	<numeric_value>
	:COUNter	
	[[:RESolution]	<numeric_value>
	:OFFSet	<numeric_value>
	:PRATio	
	[[:SET]	<numeric_value>
	:UNIT	PERCent PCT DB
	[[:IMMediate]	
	:LENGth	<numeric_value>
	:MEASurement	CARRier SPURious ACPower PODown RFENvelope CONSTe EYE STABLE
	:MODulation	
	:ADVanced	
	:FILTer	RCOSine OFF
	:PREamble	<boolean>
	:SBAND	UPPer LOWer
	:BRATe	
	:AUTO	<boolean>
	[[:SET]	<numeric_value>

:DECode	"PIE-A" "PIE-C" "FM0" "MANCHESTER" "MILLER" "MILLER-2" "MILLER-4" "MILLER-8" "M-MILLER" "NRZ" "NRZ-L8" "NRZ-L4" "NRZ-L2" "PWM" "BITCELL"
:FORMat	"ASK" "DSB-ASK" "SSB-ASK" "PR-ASK" "OOK" "SC-00K" "SC-BPSK" "FSK"
:INTerpolate	<numeric_value>
:LINK	INTerrogator TAG
:SERRor[:WIDTh]	<numeric_value>
:STANdard	"18000-4-1" "18000-6-A" "18000-6-B" "18000-6-C" "14443-2-A" "14443-2-B" "F-13.56MHz" "COG1" "C1G1" "MANUAL"
:TARI	
:AUTO	<boolean>
[:SET]	<numeric_value>
[:THReshold]	
:HIGHer	<numeric_value>
:LOWer	<numeric_value>
:OFFSet	<numeric_value>
:SPurious	
[:THReshold]	
:EXCursion	<numeric_value>
:IGNore	<numeric_value>
:SIGNa1	<numeric_value>
:SPURious	<numeric_value>
:ZOOM	
:FREQuency	
:CENTer	<numeric_value>
:WIDTh	<numeric_value>

The [:SENSe]:RFID:ACPower commands are based on the [:SENSe]:ACPower commands in the S/A mode. Refer to page 2-1036.

The [:SENSe]:RFID:SPURious commands are based on the [:SENSe]:SPURious commands in the S/A mode. Refer to page 2-1111.

[[:SENSE]:RFID:ACPower:BANDwidth]:BWIDth:ACHannel(?)

Sets or queries the adjacent channel bandwidth in the ACPR measurement.
This command is valid when [:SENSE]:RFID:MEASurement is set to ACPower.

Syntax [:SENSE]:RFID:ACPower:BANDwidth|:BWIDth:ACHannel <value>
[:SENSE]:RFID:ACPower:BANDwidth|:BWIDth:ACHannel?

Arguments <value>::=<Nrf> specifies the adjacent channel bandwidth.
Range: (bin bandwidth) × 8 to full span [Hz].
Refer to the *RSA3408A User Manual* for the bin bandwidth.

Measurement Modes DEMRFID

Examples :SENSE:RFID:ACPower:BANDwidth:ACHannel 1MHz
sets the adjacent channel bandwidth to 1 MHz in the RF ACPR measurement.

Related Commands [:SENSE]:RFID:MEASurement

[[:SENSE]:RFID:ACPower:BANDwidth]:BWIDth:INTEgration(?)

Sets or queries the main channel bandwidth in the ACPR measurement.
This command is valid when [:SENSE]:RFID:MEASurement is set to ACPower.

Syntax [:SENSE]:RFID:ACPower:BANDwidth|:BWIDth:INTEgration <value>
[:SENSE]:RFID:ACPower:BANDwidth|:BWIDth:INTEgration?

Arguments <value>::=<Nrf> specifies the main channel bandwidth.
Range: (bin bandwidth) × 8 to full span [Hz].
Refer to the *RSA3408A User Manual* for the bin bandwidth.

Measurement Modes DEMRFID

Examples :SENSE:RFID:ACPower:BANDwidth:INTEgration 1MHz
sets the main channel bandwidth to 1 MHz.

Related Commands [:SENSE]:RFID:MEASurement

[[:SENSe]:RFID:ACPower:CSPacing(?)

Sets or queries the channel-to-channel spacing in the ACPR measurement. This command is valid when [:SENSe]:RFID:MEASurement is set to CARRier.

Syntax [:SENSe]:RFID:ACPower:CSPacing <value>

[:SENSe]:RFID:ACPower:CSPacing?

Arguments <value>::=<Nrf> specifies the channel-to-channel spacing. Range: (bin bandwidth) × 8 to full span [Hz]. Refer to the *RSA3408A User Manual* for the bin bandwidth.

Measurement Modes DEMRFID

Examples :SENSe:RFID:ACPower:CSPacing 1.4MHz
sets the channel-to-channel spacing to 1.4 MHz.

Related Commands [:SENSe]:RFID:MEASurement

[[:SENSe]:RFID:ACPower:FILTer:COEFFicient(?)

Sets or queries the filter roll-off rate for the ACPR measurement when [:SENSe]:RFID:ACPower:FILTer:TYPE is set to NYQuist (Nyquist filter) or RNYQuist (Root Nyquist filter). This command is valid when [:SENSe]:RFID:MEASurement is set to CARRier.

Syntax [:SENSe]:RFID:ACPower:FILTer:COEFFicient <ratio>

[:SENSe]:RFID:ACPower:FILTer:COEFFicient?

Arguments <ratio>::=<Nrf> specifies the roll-off rate. Range: 0 to 1.

Measurement Modes DEMRFID

Examples :SENSe:RFID:ACPower:FILTer:COEFFicient 0.5
sets the filter roll-off rate to 0.5.

Related Commands [:SENSe]:RFID:ACPower:FILTer:TYPE, [:SENSe]:RFID:MEASurement

[:SENSe]:RFID:ACPower:FILTer:TYPE(?)

Selects or queries the filter for the ACPR measurement in the RFID analysis.
This command is valid when [:SENSe]:RFID:MEASurement is set to CARRIER.

Syntax [:SENSe]:RFID:ACPower:FILTer:TYPE { RECTangle | GAUSsian
| NYQuist | RNYQuist }
[:SENSe]:RFID:ACPower:FILTer:TYPE?

Arguments RECTangle selects the rectangular filter.
GAUSsian selects the Gaussian filter.
NYQuist selects the Nyquist filter (default).
RNYQuist selects the Root Nyquist filter.

Measurement Modes DEMRFID

Examples :SENSe:RFID:ACPower:FILTer:TYPE RECTangle
selects the rectangular filter for the ACPR measurement.

Related Commands [:SENSe]:RFID:MEASurement

[:SENSe]:RFID:BLOCK(?)

Sets or queries the number of the block to measure in the RFID analysis.

Syntax [:SENSe]:RFID:BLOCK <number>
[:SENSe]:RFID:BLOCK?

Arguments <number>::=<NR1> specifies the block number. Zero represents the latest block.
Range: -M to 0 (M: Number of acquired blocks)

Measurement Modes DEMRFID

Examples :SENSe:RFID:BLOCK -5
sets the block number to -5.

[[:SENSe]:RFID:CARRier:BANDwidth]:BWIDth:INTegration(?)

Sets or queries the channel bandwidth for the maximum EIRP (Effective Isotropically Radiated Power) in the RFID analysis. This command is valid when [[:SENSe]:RFID:MEASurement] is set to CARRier.

Syntax [[:SENSe]:RFID:CARRier:BANDwidth]:BWIDth:INTegration <value>
[[:SENSe]:RFID:CARRier:BANDwidth]:BWIDth:INTegration?

Arguments <value>::=<Nrf> specifies the channel bandwidth for the maximum EIRP. Range: 0 to 10 MHz.

Measurement Modes DEMRFID

Examples :SENSe:RFID:CARRier:BANDwidth:INTegration 1MHz
sets the channel bandwidth to 1 MHz.

Related Commands [[:SENSe]:RFID:MEASurement]

[[:SENSe]:RFID:CARRier:COUNter[:RESolution]()]

Sets or queries the counter resolution for the carrier measurement in the RFID analysis. This command is valid when [[:SENSe]:RFID:MEASurement] is set to CARRier.

Syntax [[:SENSe]:RFID:CARRier:COUNter[:RESolution]] <value>
[[:SENSe]:RFID:CARRier:COUNter[:RESolution]]?

Arguments <value>::=<Nrf> specifies the counter resolution for the carrier measurement. Setting values: 0.001, 0.01, 0.1, 1, 10, 100, 1k, 10k, 100k, and 1M.

Measurement Modes TIMRFID

Examples :SENSe:RFID:CARRier:COUNter:RESolution 1Hz
sets the counter resolution to 1 Hz.

Related Commands [[:SENSe]:RFID:MEASurement]

[[:SENSe]:RFID:CARRier:OFFSet(?)]

Sets or queries the amplitude offset for the maximum EIRP (Effective Isotropically Radiated Power) in the RFID analysis. This command is valid when [:SENSe]:RFID:MEASurement is set to CARRier.

Syntax [:SENSe]:RFID:CARRier:OFFSet <value>
 [:SENSe]:RFID:CARRier:OFFSet?

Arguments <value>::=<Nrf> specifies the amplitude offset for the maximum EIRP.
 Range: -100 to +100 dB.

Measurement Modes DEMRFID

Examples :SENSe:RFID:CARRier:OFFSet 10
 sets the amplitude offset for the maximum EIRP to 10 dB.

Related Commands [:SENSe]:RFID:MEASurement

[[:SENSe]:RFID:CARRier:PRATio[:SET]](?)

Sets or queries the power ratio for the OBW (Occupied Bandwidth) measurement in the RFID analysis. This command is only available when [:SENSe]:RFID:MEASurement is set to CARRier.

Syntax [:SENSe]:RFID:CARRier:PRATio[:SET] <value>
[:SENSe]:RFID:CARRier:PRATio[:SET]?

Arguments <value>::=<NRf> specifies the power ratio for the OBW measurement.
Range: -100 to +100 dB.

Measurement Modes DEMRFID

Examples :SENSe:RFID:CARRier:PRATio:SET 20
sets the power ratio to 20 dB.

Related Commands [:SENSe]:RFID:MEASurement

[[:SENSe]:RFID:CARRier:PRATio:UNIT](?)

Selects or queries the power ratio unit for the OBW (Occupied Bandwidth) measurement in the RFID analysis. This command is valid when [:SENSe]:RFID:MEASurement is set to CARRier.

Syntax [:SENSe]:RFID:CARRier:PRATio:UNIT { PERCent | PCT | DB }
[:SENSe]:RFID:CARRier:PRATio:UNIT?

Arguments PERCent and PCT select percent (%) as the power ratio unit.
DB selects dB as the power ratio unit.

Measurement Modes DEMRFID

Examples :SENSe:RFID:CARRier:PRATio:UNIT PERCent
selects percent (%) as the power ratio unit.

Related Commands [:SENSe]:RFID:MEASurement

[:SENSE]:RFID[:IMMEDIATE] (No Query Form)

Performs analysis calculation for the acquired data in the RFID analysis. To select the measurement item, use the [:SENSE]:RFID:MEASUREMENT command. To acquire data, use the :INITIATE command.

Syntax [:SENSE]:RFID[:IMMEDIATE]

Arguments None

Measurement Modes DEMRFID

Examples :SENSE:RFID:IMMEDIATE
performs calculation for the acquired data in the RFID analysis.

Related Commands :INITIATE, [:SENSE]:RFID:MEASUREMENT

[[:SENSe]:RFID:LENGth(?)

Sets or queries the range for the RFID analysis.

NOTE. The [[:SENSe]:RFID:LENGth? query may return a value smaller than the default (512) since the value is limited by the number of data points in the block.

Syntax [[:SENSe]:RFID:LENGth <value>

[[:SENSe]:RFID:LENGth?

Arguments <value>::=<NR1> specifies the analysis range by the number of data points.
Range: 1 to 256K.
To set the block size, use the [[:SENSe]:BSIZE command.

Measurement Modes DEMRFID

Examples :SENSe:RFID:LENGth 1000
sets the measurement range to 1000 points.

Related Commands [[:SENSe]:BSIZE

[[:SENSe]:RFID:MEASurement(?)]

Selects the measurement item in the RFID analysis.

The query version of this command returns the current measurement item.

Syntax [[:SENSe]:RFID:MEASurement { CARRier | SPURious | ACPower | PODown
| RFENvelope | CONSte | EYE | STABle }
[[:SENSe]:RFID:MEASurement?

Arguments Table 2-101 shows the arguments and their meanings.

Table 2-101: RFID measurement items

Argument	Measurement item
CARRier	Carrier
SPURious	Spurious
ACPower	ACPR
PODown	Power on/down
RFENvelope	RF envelope
CONSte	Constellation
EYE	Eye diagram
STABle	Symbol table

NOTE. The constellation measurement is invalid when [[:SENSe]:RFID:MODulation:STANdard is set to “COG1” or “CIG1”.

Measurement Modes DEMRFID

Examples :SENSe:RFID:MEASurement CARRier
selects the carrier measurement.

Related Commands [[:SENSe]:RFID:MODulation:STANdard

[[:SENSe]:RFID:MODulation:ADVanced:FILTer(?)]

Selects or queries the filter for the power on/down and modulation measurements in the RFID analysis.

This command is valid when [[:SENSe]:RFID:MEASurement] is set to RFENvelope, CONSt, EYE, STABle, or PODown, and [[:SENSe]:RFID:MODulation:STANdard] is set to “14443-2-A” or “14443-2-B”.

Syntax [[:SENSe]:RFID:MODulation:ADVanced:FILTer { RCOSine | OFF }

[[:SENSe]:RFID:MODulation:ADVanced:FILTer?

Arguments RCOSine selects the Raised Cosine filter.

None uses no filter.

Measurement Modes DEMRFID

Examples :SENSe:RFID:MODulation:ADVanced:FILTer RRCosine
selects the Root Raised Cosine filter.

Related Commands [[:SENSe]:RFID:MEASurement], [[:SENSe]:RFID:MODulation:STANdard]

[[:SENSe]:RFID:MODulation:ADVanced:PREamble(?)

Determines whether to search for the preamble in the power on/down and modulation measurements in the RFID analysis.

This command is valid when [:SENSe]:RFID:MEASurement is set to RFENvelope, CONSTe, EYE, STABLE, or PODown, and [:SENSe]:RFID:MODulation:STANdard is set to “14443-2-A” or “14443-2-B”.

Syntax [:SENSe]:RFID:MODulation:ADVanced:PREamble { OFF | ON | 0 | 1 }

[:SENSe]:RFID:MODulation:ADVanced:PREamble?

Arguments OFF or 0 analyzes data without searching for the preamble.

ON or 1 searches for the preamble while analyzing data.
The preamble is displayed in yellow in the symbol table.

Measurement Modes DEMRFID

Examples :SENSe:RFID:MODulation:ADVanced:PREamble ON
searches for the preamble while analyzing data.

Related Commands [:SENSe]:RFID:MEASurement, [:SENSe]:RFID:MODulation:STANdard

[[:SENSe]:RFID:MODulation:ADVanced:SBANd(?)]

Selects or queries the sideband to analyze for the power on/down and modulation measurements in the RFID analysis.

This command is valid when [[:SENSe]:RFID:MEASurement] is set to RFENvelope, CONStE, EYE, STABle, or PODown, and [[:SENSe]:RFID:MODulation:STANdard] is set to “14443-2-A” or “14443-2-B”.

Syntax [[:SENSe]:RFID:MODulation:ADVanced:SBANd { UPPER | LOWER }

[[:SENSe]:RFID:MODulation:ADVanced:SBANd?

Arguments UPPER analyzes the upper sideband.

LOWER analyzes the lower sideband.

Measurement Modes DEMRFID

Examples :SENSe:RFID:MODulation:ADVanced:SBANd UPPER
analyzes the upper sideband.

Related Commands [[:SENSe]:RFID:MEASurement], [[:SENSe]:RFID:MODulation:STANdard]

[[:SENSe]:RFID:MODulation:BRATe:AUTO(?)]

Determines whether to set the bit rate automatically or manually for the power on/down and modulation measurements in the RFID analysis.

This command is valid when [:SENSe]:RFID:MEASurement is set to RFENvelope, CONSTe, EYE, STABLE, or PODown, and [:SENSe]:RFID:MODulation:DECode is set to other than “PIE-A” and “PIE-C”.

Syntax [:SENSe]:RFID:MODulation:BRATe:AUTO { OFF | ON | 0 | 1 }

[:SENSe]:RFID:MODulation:BRATe:AUTO?

Arguments OFF or 0 sets the bit rate manually.
Use the [:SENSe]:RFID:MODulation:BRATe[:SET] command to set the bit rate.
ON or 1 sets the bit rate automatically.

NOTE. For the power on/down measurement, the [:SENSe]:RFID:MODulation:BRATe:AUTO setting is fixed to Off.

Measurement Modes DEMRFID

Examples :SENSe:RFID:MODulation:BRATe:AUTO ON
sets the bit rate automatically.

Related Commands [:SENSe]:RFID:MEASurement, [:SENSe]:RFID:MODulation:BRATe[:SET],
[:SENSe]:RFID:MODulation:DECode

[[:SENSe]:RFID:MODulation:BRATe[:SET](?)

Sets or queries the bit rate for the power on/down and modulation measurements when [:SENSe]:RFID:MODulation:BRATe:AUTO is set to Off.

This command is valid when [:SENSe]:RFID:MEASurement is set to RFENvelope, CONSTe, EYE, STABLE, or PODown, and [:SENSe]:RFID:MODulation:DECode is set to other than “PIE-A” and “PIE-C”.

Syntax [:SENSe]:RFID:MODulation:BRATe[:SET] <value>
[:SENSe]:RFID:MODulation:BRATe[:SET]?

Arguments <value>::=<NRf> specifies the bit rate. Range: 1 bps to 51.2 Mbps.

Measurement Modes DEMRFID

Examples :SENSe:RFID:MODulation:BRATe:SET 40k
sets the bit rate to 40 kbps.

Related Commands [:SENSe]:RFID:MEASurement, [:SENSe]:RFID:MODulation:BRATe:AUTO,
[:SENSe]:RFID:MODulation:DECode

[:SENSe]:RFID:MODulation:DECode(?)

Selects or queries the decoding format for the power on/down and modulation measurements in the RFID analysis.

This command is valid when [:SENSe]:RFID:MEASurement is set to RFENvelope, CONSTe, EYE, STABLE, or PODown.

Syntax [:SENSe]:RFID:MODulation:DECode { "PIE-A" | "PIE-C" | "FM0"
| "MANCHESTER" | "MILLER" | "MILLER-2" | "MILLER-4" | "MILLER-8"
| "M-MILLER" | "NRZ" | "NRZ-L8" | "NRZ-L4" | "NRZ-L2"
| "PWM" | "BITCELL" }

[:SENSe]:RFID:MODulation:DECode?

Arguments Table 2-102 shows the arguments and their meanings.

Table 2-102: Decoding format

Argument	Decoding format
"PIE-A"	PIE Type A
"PIE-C"	PIE Type C
"FM0"	FM0
"MANCHESTER"	Manchester
"MILLER"	Miller
"MILLER-2"	Miller (M_2)
"MILLER-4"	Miller (M_4)
"MILLER-8"	Miller (M_8)
"M-MILLER"	Mdifited Miller
"NRZ"	NRZ
"NRZ-L8"	NRZ-L (8 periods)
"NRZ-L4"	NRZ-L (4 periods)
"NRZ-L2"	NRZ-L (2 periods)
"PWM"	PWM (Pulse Width Modulation)
"BITCELL"	Bit Cell

Measurement Modes DEMRFID

Examples :SENSe:RFID:MODulation:DECode "FM0"
selects the FM0 decoding format.

Related Commands [:SENSe]:RFID:MEASurement

[:SENSe]:RFID:MODulation:FORMat(?)

Selects or queries the modulation format for the power on/down and modulation measurements in the RFID analysis.

This command is valid when [:SENSe]:RFID:MEASurement is set to RFENvelope, CONSTe, EYE, STABLE, or PODown.

Syntax [:SENSe]:RFID:MODulation:FORMat { "ASK" | "DSB-ASK" | "SSB-ASK"
| "PR-ASK" | "OOK" | "SC-OOK" | "SC-BPSK" | "FSK" }

[:SENSe]:RFID:MODulation:FORMat?

Arguments Table 2-103 shows the arguments and their meanings.

Table 2-103: Modulation format

Argument	Modulation format
"ASK"	ASK
"DSB-ASK"	DSB-ASK
"SSB-ASK"	SSB-ASK
"PR-ASK"	PR-ASK
"OOK"	OOK
"SC-OOK"	Subcarrier OOK
"SC-BPSK"	Subcarrier BPSK
"FSK"	FSK

Measurement Modes DEMRFID

Examples :SENSe:RFID:MODulation:FORMat "ASK"
selects the ASK modulation.

Related Commands [:SENSe]:RFID:MEASurement

[:SENSe]:RFID:MODulation:INTerpolate(?)

Sets or queries the number of waveform interpolation points for the power on/down and modulation measurements in the RFID analysis. This is equivalent to setting **Interpolation Points** in the Meas Setup menu.

This command is valid when [:SENSe]:RFID:MEASurement is set to RFENvelope, CONSTe, EYE, STABLE, or PODown.

Syntax [:SENSe]:RFID:MODulation:INTerpolate <value>

[:SENSe]:RFID:MODulation:INTerpolate?

Arguments <value>::=<Nrf> specifies the number of waveform interpolation points. Range: 0 to 7 (default: 0). Zero means no interpolation.

Measurement Modes DEMRFID

Examples :SENSe:RFID:MODulation:INTerpolate 3
sets the number of interpolation points to 3.

Related Commands [:SENSe]:RFID:MEASurement

[[:SENSe]:RFID:MODulation:LINK(?)]

Selects or queries the link for the power on/down and modulation measurements in the RFID analysis.

This command is valid when [[:SENSe]:RFID:MEASurement] is set to RFENvelope, CONSTe, EYE, STABLE, or PODown.

Syntax [[:SENSe]:RFID:MODulation:LINK { INTERrogator | TAG }]

[[:SENSe]:RFID:MODulation:LINK?

Arguments INTERrogator detects the interrogator preamble from a measurement signal and decodes the signal with the interrogator decoding format.

TAG detects the tag preamble from a measurement signal and decodes the signal with the tag decoding format.

Measurement Modes DEMRFID

Examples :SENSe:RFID:MODulation:LINK INTERrogator
detects the interrogator preamble from a measurement signal and decodes the signal with the interrogator decoding format.

Related Commands [[:SENSe]:RFID:MEASurement]

[[:SENSE]:RFID:MODulation:SERRor[:WIDTh](?)

Sets or queries an error range for determining the settling time in the power on/down and modulation measurements of the RFID analysis. This is equivalent to setting **Settling Error Width** in the Meas Setup menu.

This command is valid when [:SENSE]:RFID:MEASurement is set to RFENvelope, CONSTe, EYE, STABLE, or PODown.

Syntax [:SENSE]:RFID:MODulation:SERRor[:WIDTh] <value>

[:SENSE]:RFID:MODulation:SERRor[:WIDTh]?

Arguments <value>::=<Nrf> specifies the error range for determining the settling time.
Range: 1 to 100%.

Measurement Modes DEMRFID

Examples :SENSE:RFID:MODulation:SERRor:WIDTh 5
sets the error range to 5%.

Related Commands [:SENSE]:RFID:MEASurement

[:SENSe]:RFID:MODulation:STANdard(?)

Selects or queries the demodulation standard for the power on/down and modulation measurements in the RFID analysis.

This command is valid when [:SENSe]:RFID:MEASurement is set to RFENvelope, CONStE, EYE, STABLE, or PODown.

Syntax [:SENSe]:RFID:MODulation:STANdard { "18000-4-1" | "18000-6-A" | "18000-6-B" | "18000-6-C" | "14443-2-A" | "14443-2-B" | "F-13.56MHz" | "C0G1" | "C1G1" | "MANUAL" }

[:SENSe]:RFID:MODulation:STANdard?

Arguments Table 2-104 shows the arguments and their meanings.

Table 2-104: RFID demodulation standard

Argument	Standard
"18000-4-1"	ISO/IEC 18000-4 Mode 1
"18000-6-A"	ISO/IEC 18000-6 Type A
"18000-6-B"	ISO/IEC 18000-6 Type B
"18000-6-C"	ISO/IEC 18000-6 Type C
"14443-2-A"	ISO/IEC 14443-2 Type A
"14443-2-B"	ISO/IEC 14443-2 Type B
"F-13.56MHz"	F-13.56 MHz
"C0G1"	EPCglobal Gen1 Class0
"C1G1"	EPCglobal Gen1 Class1
"MANUAL"	Sets parameters manually

Measurement Modes DEMRFID

Examples :SENSe:RFID:MODulation:STANdard "18000-4-1"
selects the ISO/IEC 18000-4 Mode 1 standard.

Related Commands [:SENSe]:RFID:MEASurement

[[:SENSe]:RFID:MODulation:TARI:AUTO(?)]

Determines whether to set Tari automatically or manually for the power on/down and modulation measurements in the RFID analysis.

This command is valid when [:SENSe]:RFID:MEASurement is set to RFENvelope, CONSTe, EYE, STABLE, or PODown, and [:SENSe]:RFID:MODulation:DECode is set to “PIE-A” or “PIE-C”.

Syntax [:SENSe]:RFID:MODulation:TARI:AUTO { OFF | ON | 0 | 1 }

[:SENSe]:RFID:MODulation:TARI:AUTO?

Arguments OFF or 0 sets Tari manually.
Use the [:SENSe]:RFID:MODulation:TARI[:SET] command to set Tari.
ON or 1 sets the Tari automatically.

NOTE. For the power on/down measurement, the [:SENSe]:RFID:MODulation:TARI:AUTO setting is fixed to Off.

Measurement Modes DEMRFID

Examples :SENSe:RFID:MODulation:TARI:AUTO ON
sets Tari automatically.

Related Commands [:SENSe]:RFID:MEASurement, [:SENSe]:RFID:MODulation:TARI[:SET],
[:SENSe]:RFID:MODulation:DECode

[[:SENSe]:RFID:MODulation:TARI[:SET]](?)

Sets or queries Tari for the power on/down and modulation measurements when [:SENSe]:RFID:MODulation:TARI:AUTO is set to On.

This command is valid when [:SENSe]:RFID:MEASurement is set to RFENvelope, CONSTe, EYE, STABLE, or PODown, and [:SENSe]:RFID:MODulation:DECode is set to “PIE-A” and “PIE-C”.

Syntax [:SENSe]:RFID:MODulation:TARI[:SET] <value>

[:SENSe]:RFID:MODulation:TARI[:SET]?

Arguments <value>::=<NRf> specifies Tari. Range: 1 ns to 1 s.

Measurement Modes DEMRFID

Examples :SENSe:RFID:MODulation:TARI:SET 25u
ses Tari to 25 μ s.

Related Commands [:SENSe]:RFID:MEASurement, [:SENSe]:RFID:MODulation:TARI:AUTO,
[:SENSe]:RFID:MODulation:DECode

[:SENSe]:RFID:MODulation[:THReshold]:HIGHer(?)

Sets or queries the higher threshold for measuring a rise/fall time of a pulse. This command is valid when [:SENSe]:RFID:MEASurement is set to RFENvelope, CONStE, EYE, STABLE, or PODown.

Syntax [:SENSe]:RFID:MODulation[:THReshold]:HIGHer <value>
[:SENSe]:RFID:MODulation[:THReshold]:HIGHer?

Arguments <value>::=<NRf> specifies the higher threshold. Range: 50 to 99%.

Measurement Modes DEMRFID

Examples :SENSe:RFID:MODulation:THReshold 90
sets the higher threshold to 90%.

Related Commands [:SENSe]:RFID:MEASurement

[:SENSe]:RFID:MODulation[:THReshold]:LOWer(?)

Sets or queries the lower threshold for measuring a rise/fall time of a pulse. This command is valid when [:SENSe]:RFID:MEASurement is set to RFENvelope, CONStE, EYE, STABLE, or PODown.

Syntax [:SENSe]:RFID:MODulation[:THReshold]:LOWer <value>
[:SENSe]:RFID:MODulation[:THReshold]:LOWer?

Arguments <value>::=<NRf> specifies the lower threshold. Range: 1 to 50%.

Measurement Modes DEMRFID

Examples :SENSe:RFID:MODulation:THReshold 10
sets the lower threshold to 10%.

Related Commands [:SENSe]:RFID:MEASurement

[[:SENSe]:RFID:OFFSet(?)]

Sets or queries the measurement start position in the RFID analysis.

NOTE. The [[:SENSe]:RFID:OFFSet?] query may return a value greater than the default (0) since the value is limited by the trigger position in the block.

Syntax [[:SENSe]:RFID:OFFSet <value>

[[:SENSe]:RFID:OFFSet?

Arguments <value>::=<NR1> specifies the measurement start position by the number of points. Range: 0 to $1024 \times (\text{block size}) - 1$. To set the block size, use the [[:SENSe]:BSIZE command.

Measurement Modes TIMRFID

Examples :SENSe:RFID:OFFSet 500
sets the measurement start position to Point #500.

Related Commands [[:SENSe]:BSIZE

[[:SENSe]:RFID:SPURious[:THReshold]:EXCursion(?)

Sets or queries the excursion level to determine if the signal is spurious for the spurious measurement in the RFID analysis. This command is valid when [:SENSe]:RFID:MEASurement is set to SPURious.

Syntax [:SENSe]:RFID:SPURious[:THReshold]:EXCursion <value>
[:SENSe]:RFID:SPURious[:THReshold]:EXCursion?

Arguments <value>::=<NRf> specifies the excursion level to determine if the signal is spurious. Range: 0 to 30 dB.

Measurement Modes DEMRFID

Examples :SENSe:RFID:SPURious:THReshold:EXCursion 5
sets the excursion level to 5 dB.

Related Commands [:SENSe]:RFID:MEASurement

[[:SENSe]:RFID:SPURious[:THReshold]:IGNore(?)

Sets or queries the region not to detect spurious signals around the carrier peak signal to avoid mistaking spurious for the spurious measurement in the RFID analysis. This command is valid when [:SENSe]:RFID:MEASurement is set to SPURious.

Syntax [:SENSe]:RFID:SPURious[:THReshold]:IGNore <value>
[:SENSe]:RFID:SPURious[:THReshold]:IGNore?

Arguments <value>::=<NRf> specifies the ignore range. Range: 0 to Span/2 Hz.

Measurement Modes DEMRFID

Examples :SENSe:RFID:SPURious:THReshold:IGNore 5MHz
sets the ignore range to 5 MHz.

Related Commands [:SENSe]:RFID:MEASurement

[[:SENSe]:RFID:SPURious[:THReshold]:SIGNaI(?]

Sets or queries the threshold level to determine if the signal is the carrier for the spurious measurement in the RFID analysis. This command is valid when [:SENSe]:RFID:MEASurement is set to SPURious.

Syntax [:SENSe]:RFID:SPURious[:THReshold]:SIGNaI <value>
[:SENSe]:RFID:SPURious[:THReshold]:SIGNaI?

Arguments <value>::=<NRf> specifies the threshold level to determine if the signal is the carrier. Range: -100 to +30 dBm.

Measurement Modes DEMRFID

Examples :SENSe:RFID:SPURious:THReshold:SIGNaI -30
sets the carrier threshold level to -30 dBm.

Related Commands [:SENSe]:RFID:MEASurement

[[:SENSe]:RFID:SPURious[:THReshold]:SPURious(?]

Sets or queries the threshold level to determine if the signal is spurious for the spurious measurement in the RFID analysis. This command is valid when [:SENSe]:RFID:MEASurement is set to SPURious.

Syntax [:SENSe]:RFID:SPURious[:THReshold]:SPURious <value>
[:SENSe]:RFID:SPURious[:THReshold]:SPURious?

Arguments <value>::=<NRf> specifies the threshold level to determine if the signal is the spurious relative to the carrier peak. Range: -90 to -30 dBc.

Measurement Modes DEMRFID

Examples :SENSe:RFID:SPURious:THReshold:SPURious -70
sets the threshold level to -70 dBc.

Related Commands [:SENSe]:RFID:MEASurement

[[:SENSE]:RFID:ZOOM:FREQUENCY:CENTER(?)]

Sets or queries the center frequency of a zoomed area. This command is valid when :DISPlay:RFID:OView:FORMat is set to ZOOM.

Syntax [[:SENSE]:RFID:ZOOM:FREQUENCY:CENTER <value>

[[:SENSE]:RFID:ZOOM:FREQUENCY:CENTER?

Arguments <value>::=<Nrf> specifies the center frequency of a zoomed area. The setting value must be within the measurement frequency range.

Measurement Modes DEMRFID

Examples :SENSE:RFID:ZOOM:FREQUENCY:CENTER 1.75GHz
sets the center frequency of the zoomed area to 1.75 GHz.

Related Commands :DISPlay:RFID:OView:FORMat

[[:SENSE]:RFID:ZOOM:FREQUENCY:WIDTH(?)]

Sets or queries the frequency width of a zoomed area. This command is valid when :DISPlay:RFID:OView:FORMat is set to ZOOM.

Syntax [[:SENSE]:RFID:ZOOM:FREQUENCY:WIDTH <value>

[[:SENSE]:RFID:ZOOM:FREQUENCY:WIDTH?

Arguments <value>::=<Nrf> specifies the frequency width of a zoomed area. The setting value must be within the measurement frequency range.

Measurement Modes DEMRFID

Examples :SENSE:RFID:ZOOM:FREQUENCY:WIDTH 500kHz
sets the frequency width of the zoomed area to 500 kHz.

Related Commands :DISPlay:RFID:OView:FORMat

[[:SENSe]:SSource Subgroup

Signal Source Analysis, Option 21 Only

The [[:SENSe]:SSource commands set up the conditions related to the signal source analysis.

NOTE. *To use a command from this group, you must have selected TIMS-SOURCE (signal source analysis) in the :INSTrument[:SElect] command.*

Command Tree	Header	Parameter
	[:SENSe]	
	:SSource	
	:BLOCk	<numeric_value>
	:CARRier	
	:BANDwidth :BWIDth	
	:INTegration	<numeric_value>
	[:THReshold]	<numeric_value>
	:TRACking	
	[:STATe]	<boolean>
	:CNRatio	
	:FFT	
	:LENGth	<numeric_value>
	:OFFSet	<numeric_value>
	:SBANd	UPPer LOWer
	[:THReshold]	<numeric_value>
	:FVTime	
	:SMOothing	<numeric_value>
	[:THReshold]	<numeric_value>
	[:IMMediate]	
	:LENGth	<numeric_value>
	:MEASurement	OFF PNOise SPURious RTPNoise RTSPurious FVTime }
	:OFFSet	<numeric_value>
	:PNOise	
	:MPJitter	
	[:THReshold]	<numeric_value>
	:RJITter	
	:OFFSet	
	:START	<numeric_value>
	:STOP	<numeric_value>
	[:THReshold]	<numeric_value>
	:OFFSet	<numeric_value>
	:MAXimum	<numeric_value>
	:MINimum	<numeric_value>
	:SPURious	
	:IGNore	<numeric_value>
	:SFILter	
	[:STATe]	<boolean>
	[:THReshold]	
	:EXCursion	<numeric_value>
	:SPURious	<numeric_value>

[[:SENSe]:SSource:BLOCK(?)]

Sets or queries the number of the block to measure in the signal source analysis.

This command is valid when [[:SENSe]:SSource:MEASurement] is set to RTPNoise, RTSPurious, or FVTime.

Syntax [[:SENSe]:SSource:BLOCK <number>

[[:SENSe]:SSource:BLOCK?

Arguments <number>::=<NR1> specifies the block number. Zero represents the latest block.
Range: -M to 0 (M: Number of acquired blocks)

Measurement Modes TIMSSOURCE

Examples :SENSe:SSource:BLOCK -5
sets the block number to -5.

Related Commands [[:SENSe]:SSource:MEASurement

[[:SENSE]:SSource:CARRier:BANDwidth]:BWIDth:INTEgration(?)

Sets or queries the frequency bandwidth to calculate channel power in the signal source analysis.

This command is valid when [:SENSE]:SSource:MEASurement is set to PNOise, RTPNoise, or RTSPurious.

Syntax [:SENSE]:SSource:CARRier:BANDwidth]:BWIDth:INTEgration <value>

[:SENSE]:SSource:CARRier:BANDwidth]:BWIDth:INTEgration?

Arguments <value>::=<NR1> specifies the frequency bandwidth to calculate channel power.
Range: Span/100 to Span/2 Hz.

Measurement Modes TIMSSOURCE

Examples :SENSE:SSource:CARRier:BANDwidth:INTEgration 1MHz
sets the bandwidth to 1 MHz.

Related Commands [:SENSE]:SSource:MEASurement

[:SENSe]:SSource:CARRier[:THReshold](?)

Sets or queries the threshold for carrier detection in the signal source analysis. A signal with amplitude above the threshold is detected as a carrier.

This command is only available when [:SENSe]:SSource:MEASurement is set to PNOise, SPURious, RTPNoise, or RTSPurious.

Syntax [:SENSe]:SSource:CARRier[:THReshold] <value>

[:SENSe]:SSource:CARRier[:THReshold]?

Arguments <value>::=<NRf> specifies threshold level for carrier detection.
Range: -100 to +30 dBm (default: -20 dBm).

Measurement Modes TIMSSOURCE

Examples :SENSe:SSource:CARRier:THReshold -10
sets the threshold level to -10 dBm.

Related Commands [:SENSe]:SSource:MEASurement

[:SENSe]:SSource:CARRier:TRACking[:STATe](?)

Selects whether carrier tracking is executed or not in the signal source analysis. Carrier tracking ensures that the carrier frequency is always positioned centrally, even when the signal drifts (it does not affect the waveform display).

This command is valid when [:SENSe]:SSource:MEASurement is set to SPURious or RTSPurious.

Syntax [:SENSe]:SSource:CARRier:TRACking[:STATe] { OFF | ON | 0 | 1 }
[:SENSe]:SSource:CARRier:TRACking[:STATe]?

Arguments OFF or 0 disables the carrier tracking.
ON or 1 enables the carrier tracking.

Measurement Modes TIMSSOURCE

Examples :SENSe:SSource:CARRier:TRACking:STATe ON
enables the carrier tracking.

Related Commands [:SENSe]:SSource:MEASurement

[:SENSe]:SSource:CNRatio:FFT:LENGth(?)

Sets or queries the number of FFT samples per frame in the real-time phase noise measurement of the signal source analysis.

This command is valid when [:SENSe]:SSource:MEASurement is set to RTPNoise.

Syntax [:SENSe]:SSource:CNRatio:FFT:LENGth <value>

[:SENSe]:SSource:CNRatio:FFT:LENGth?

Arguments <value>::=<NR1> specifies the number of FFT samples.
Range: 64 to 65536 in powers of two (default: 1024)

Measurement Modes TIMSSOURCE

Examples :SENSe:SSource:CNRatio:FFT:LENGth 2048
sets the FFT length to 2048 points.

Related Commands [:SENSe]:SSource:MEASurement

[[:SENSE]:SSource:CNRatio:OFFSet(?)]

Sets or queries the frequency displaying the C/N versus Time in the subview. This is equivalent to setting **C/N Offset Frequency** in the Meas Setup menu.

This command is valid when [[:SENSE]:SSource:MEASurement] is set to RTPNoise.

Syntax [[:SENSE]:SSource:CNRatio:OFFSet <value>

[[:SENSE]:SSource:CNRatio:OFFSet?

Arguments <value>::=<Nrf> specifies the value of the frequency displaying the C/N versus Time in the subview as the offset from carrier frequency. The setting value must be within the frequency range of the real-time phase noise measurement.

Measurement Modes TIMSSOURCE

Examples :SENSE:SSource:CNRatio:OFFSet 50kHz
sets the offset to 50 kHz.

Related Commands [[:SENSE]:SSource:MEASurement]

[[:SENSe]:SSource:CNRatio:SBANd(?)

Selects or queries the sideband for measuring phase noise in the signal source analysis.

This command is valid when [[:SENSe]:SSource:MEASurement is set to PNOise, RTPNoise, or RTSPurious.

Syntax [[:SENSe]:SSource:CNRatio:SBANd { UPPER | LOWER }
[[:SENSe]:SSource:CNRatio:SBANd?

Arguments UPPER measures the upper sideband (default).
LOWER measures the lower sideband.

Measurement Modes TIMSSOURCE

Examples :SENSe:SSource:CNRatio:SBANd UPPER
measures the upper sideband.

Related Commands [[:SENSe]:SSource:MEASurement

[[:SENSe]:SSource:CNRatio[:THReshold](?)

Sets or queries the threshold value for obtaining the phase noise settling time in the signal source analysis. This is equivalent to setting **C/N Settling Threshold** in the Meas Setup menu.

This command is valid when [:SENSe]:SSource:MEASurement is set to RTPNoise.

Syntax [:SENSe]:SSource:CNRatio[:THReshold] <value>

[:SENSe]:SSource:CNRatio[:THReshold]?

Arguments <value>: :=<NRf> specifies the threshold value for obtaining the phase noise settling time. Range: -200 to 0 dBc/Hz.

Measurement Modes TIMSSOURCE

Examples :SENSe:SSource:CNRatio:THReshold -20
sets the threshold to -20 dBc/Hz.

Related Commands [:SENSe]:SSource:MEASurement

[:SENSe]:SSource:FVTime:SMOothing(?)

Sets or queries the smoothing factor for the frequency versus time measurement in the signal source analysis. This command valid when [:SENSe]:SSource:MEASurement is set to FVTime.

Syntax [:SENSe]:SSource:FVTime:SMOothing <value>
 [:SENSe]:SSource:FVTime:SMOothing?

Arguments <value>::=<NRf> specifies the smooting factor.
 Range: 1 to (analysis length)/2.

Measurement Modes TIMSSOURCE

Examples :SENSe:SSource:FVTime:SMOothing 10
 sets the smooting factor to 10.

Related Commands [:SENSe]:SSource:MEASurement

[:SENSe]:SSource:FVTime[:THReshold](?)

Sets or queries the threshold for judging the frequency settling time in the signal source analysis. This is equivalent to setting **Freq Settling Threshold** in the Meas Setup menu. This command valid when [:SENSe]:SSource:MEASurement is set to FVTime.

Syntax [:SENSe]:SSource:FVTime[:THReshold] <value>
 [:SENSe]:SSource:FVTime[:THReshold]?

Arguments <value>::=<NRf> specifies the frequency settling threshold.
 Range: Span/100 to Span/2 Hz.

Measurement Modes TIMSSOURCE

Examples :SENSe:SSource:FVTime:THReshold 10MHz
 sets the frequency settling threshold to 10 MHz.

Related Commands [:SENSe]:SSource:MEASurement

[:SENSe]:SSource[:IMMediate] (No Query Form)

Performs analysis calculation for the acquired data in the signal source analysis. To select the measurement, use the [:SENSe]:SSource:MEASurement command.

Syntax [:SENSe]:SSource[:IMMediate]

Arguments None

Measurement Modes TIMSSOURCE

Examples :SENSe:SSource:IMMediate
performs calculation for the acquired data in the signal source analysis.

Related Commands [:SENSe]:SSource:MEASurement

[[:SENSe]:SSource:LENGth(?)

Sets or queries the range for the signal source analysis.

This command is valid when [[:SENSe]:SSource:MEASurement is set to RTPNoise, RTSPurious, or FVTime.

NOTE. The [[:SENSe]:SSource:LENGth? query may return a value smaller than the default (1024) since the value is limited by the number of data points in the block.

Syntax [[:SENSe]:SSource:LENGth <value>
[[:SENSe]:SSource:LENGth?

Arguments <value>::=<NR1> specifies the analysis length by the number of data points. The setting range depends on option and measurement item as shown in Table 2-105.

Table 2-105: Analysis length setting range

Option	Setting range
Other than Option 02	The smaller of 1 to [1024 × (block size)] or [8192-512=7680]
Option 02 (256 MB memory)	Real-time phase noise and real-time spurious measurements: 1 to 65,534,976 (1024 × (maximum block size=64000) - 1024) Frequency versus Time: 1 to 512,000 (500 frames - 1024)

To set the block size, use the [[:SENSe]:BSIZE command.

Measurement Modes TIMSSOURCE

Examples :SENSe:SSource:LENGth 1000
sets the measurement range to 1000 points.

Related Commands [[:SENSe]:BSIZE, [[:SENSe]:SSource:MEASurement

[:SENSe]:SSource:MEASurement(?)

Selects and runs the measurement item in the signal source analysis.
The query version of this command returns the current measurement item.

Syntax [:SENSe]:SSource:MEASurement { OFF | PNOise | SPURious | RTPNoise
| RTSPurious | FVTime }
[:SENSe]:SSource:MEASurement?

Arguments Table 2-106 shows the arguments and their meanings.

Table 2-106: SSOURCE measurement items

Argument	Measurement item
OFF	Turns off the measurement
PNOise	Phase noise
SPURious	Spurious
RTPNoise	Real-time phase noise
RTSPurious	Real-time spurious
FVTime	Frequency versus Time

Measurement Modes TIMSSOURCE

Examples :SENSe:SSource:MEASurement PNOise
selects and runs the phase noise measurement.

[[:SENSe]:SSource:OFFSet(?)]

Sets or queries the measurement start position in the signal source analysis.

This command is valid when [[:SENSe]:SSource:MEASurement] is set to RTPNoise, RTSPurious, or FVTime.

NOTE. The [[:SENSe]:SSource:OFFSet?] query may return a value greater than the default (0) since the value is limited by the trigger position in the block.

Syntax [[:SENSe]:SSource:OFFSet <value>

[[:SENSe]:SSource:OFFSet?

Arguments <value> ::= <NR1> defines the measurement start position by the number of points. Range: 0 to $1024 \times (\text{Block size}) - 1$. To set the block size, use the [[:SENSe]:BSIZE] command.

Measurement Modes TIMSSOURCE

Examples :SENSe:SSource:OFFSet 500
sets the measurement start position to point 500.

Related Commands [[:SENSe]:BSIZE], [[:SENSe]:SSource:MEASurement]

[[:SENSE]:SSource:PNOise:MPJitter[:THReshold](?)

Sets or queries the threshold level to determine periodic jitter in the signal source analysis. This is equivalent to setting **Max Pj Threshold** in the Meas Setup menu.

This command is valid when [:SENSE]:SSource:MEASurement is set to PNOise or RTPNoise.

Syntax [:SENSE]:SSource:PNOise:MPJitter[:THReshold] <value>

[:SENSE]:SSource:PNOise:MPJitter[:THReshold]?

Arguments <value>::=<NRf> specifies the threshold level to determine periodic jitter.
Range: 1 to 50 dB (default: 10 dB)

Measurement Modes TIMSSOURCE

Examples :SENSE:SSource::PNOise:MPJitter:THReshold 20dB
sets the threshold level to 20 dB.

Related Commands [:SENSE]:SSource:MEASurement

[[:SENSe]:SSource:PNOise:RJITter:OFFSet:START(?)]

Sets or queries the random jitter measurement start frequency as the offset from carrier frequency in the signal source analysis. This is equivalent to setting **Rj Start Offset Frequency** in the Meas Setup menu.

This command is valid when [:SENSe]:SSource:MEASurement is set to PNOise or RTPNoise.

Syntax [:SENSe]:SSource:PNOise:RJITter:OFFSet:START <value>

[:SENSe]:SSource:PNOise:RJITter:OFFSet:START?

Arguments <value>: :=<Nrf> specifies the random jitter measurement start frequency as the offset from carrier frequency.

Range: 10 Hz (default) to the stop offset frequency

The stop offset frequency is set using the [:SENSe]:SSource:PNOise:RJITter:OFFSet:STOP command.

Measurement Modes TIMSSOURCE

Examples :SENSe:SSource::PNOise:RJITter:OFFSet:START 10kHz
sets the start frequency offset to 10 kHz for the random jitter measurement.

Related Commands [:SENSe]:SSource:MEASurement,
[:SENSe]:SSource:PNOise:RJITter:OFFSet:STOP

[[:SENSE]:SSource:PNOise:RJITter:OFFSet:STOP(?)]

Sets or queries the random jitter measurement stop frequency as the offset from carrier frequency in the signal source analysis. This is equivalent to setting **Rj Stop Offset Frequency** in the Meas Setup menu.

This command is valid when [:SENSE]:SSource:MEASurement is set to PNOise or RTPNoise.

Syntax [:SENSE]:SSource:PNOise:RJITter:OFFSet:STOP <value>

[:SENSE]:SSource:PNOise:RJITter:OFFSet:STOP?

Arguments <value>: :=<NRf> specifies the random jitter measurement stop frequency as the offset from carrier frequency.

Range: The start offset frequency to 100 MHz (default)

The start offset frequency is set using the [:SENSE]:SSource:PNOise:RJITter:OFFSet:START command.

Measurement Modes TIMSSOURCE

Examples :SENSE:SSource::PNOise:RJITter:OFFSet:STOP 1MHz
sets the stop offset frequency to 1 MHz for the random jitter measurement.

Related Commands [:SENSE]:SSource:MEASurement,
[:SENSE]:SSource:PNOise:RJITter:OFFSet:START

[[:SENSe]:SSource:PNOise:RJITter[:THReshold](?)

Sets or queries the threshold value for obtaining the random jitter settling time in the real-time phase noise measurement. This is equivalent to setting **Rj Settling Threshold** in the Meas Setup menu.

This command is valid when [:SENSe]:SSource:MEASurement is set to RTPNoise.

Syntax [:SENSe]:SSource:PNOise:RJITter[:THReshold] <value>

[:SENSe]:SSource:PNOise:RJITter[:THReshold]?

Arguments <value>: :=<NRf> specifies the threshold value for obtaining the random jitter settling time. Range: 0 to 1 s (default: 0).

Measurement Modes TIMSSOURCE

Examples :SENSe:SSource:PNOise:RJITter:THReshold 0.2ps
sets the threshold value to 0.2 ps.

Related Commands [:SENSe]:SSource:MEASurement

[:SENSe]:SSource:PNOise:OFFSet:MAXimum(?)

Sets or queries the maximum frequency in the phase noise measurement range as the offset from carrier frequency. This is equivalent to setting **Maximum Offset Frequency** in the Meas Setup menu.

This command is valid when [:SENSe]:SSource:MEASurement is set to PNOise.

Syntax [:SENSe]:SSource:PNOise:OFFSet:MAXimum <value>

[:SENSe]:SSource:PNOise:OFFSet:MAXimum?

Arguments <value>::=<NRf> specifies the maximum frequency in the phase noise measurement range as the offset from carrier frequency:
100 Hz, 1 kHz, 10 kHz, 100 kHz, 1 MHz, 10 MHz, or 100 MHz (default)

Measurement Modes TIMSSOURCE

Examples :SENSe:SSource:PNOise:OFFSet:MAXimum 1MHz
sets the maximum offset frequency to 1 MHz.

Related Commands [:SENSe]:SSource:MEASurement,
[:SENSe]:SSource:PNOise:OFFSet:MINimum

[:SENSe]:SSource:PNOise:OFFSet:MINimum(?)

Sets or queries the minimum frequency in the phase noise measurement range as the offset from carrier frequency. This is equivalent to setting **Minimum Offset Frequency** in the Meas Setup menu.

This command is valid when [:SENSe]:SSource:MEASurement is set to PNOise.

Syntax [:SENSe]:SSource:PNOise:OFFSet:MINimum <value>

[:SENSe]:SSource:PNOise:OFFSet:MINimum?

Arguments <value>::=<NRf> specifies the minimum frequency in the phase noise measurement range as the offset from carrier frequency:
10 Hz (default), 100 Hz, 1 kHz, 10 kHz, 100 kHz, 1 MHz, or 10 MHz

Measurement Modes TIMSSOURCE

Examples :SENSe:SSource:PNOise:OFFSet:MINimum 10kHz
sets the minimum frequency offset to 10 kHz.

Related Commands [:SENSe]:SSource:MEASurement,
[:SENSe]:SSource:PNOise:OFFSet:MAXimum

[[:SENSE]:SSOURCE:SPURIOUS:IGNORE(?)]

Sets or queries the ignore region for the spurious measurement in the signal source analysis. This command has the same function as [[:SENSE]:SPURIOUS[:THRESHOLD]:IGNORE] on page 2-1113.

This command is valid when [[:SENSE]:SSOURCE:MEASUREMENT] is set to SPURIOUS or RTSPURIOUS.

Syntax [[:SENSE]:SSOURCE:SPURIOUS:IGNORE <value>

[[:SENSE]:SSOURCE:SPURIOUS:IGNORE?

Arguments <value>::=<NRf> specifies the ignore region. Range: 0 to Span/2 [Hz].

Measurement Modes TIMSSOURCE

Examples :SENSE:SSOURCE:SPURIOUS:IGNORE 1MHz
sets the ignore region to 1 MHz.

Related Commands [[:SENSE]:SSOURCE:MEASUREMENT], [[:SENSE]:SPURIOUS[:THRESHOLD]:IGNORE]

[[:SENSe]:SSource:SPURious:SFILter[:STATe](?)

Determines whether to enable the symmetrical filter in the spurious measurement of the signal source analysis.

This command is valid when [[:SENSe]:SSource:MEASurement is set to SPURious or RTSPurious.

Syntax [[:SENSe]:SSource:SPURious:SFILter[:STATe] { OFF | ON | 0 | 1 }
[[:SENSe]:SSource:SPURious:SFILter[:STATe]?

Arguments OFF or 0 disables the symmetrical filter.
All spurious signals are displayed.
ON or 1 enables the symmetrical filter.
Only symmetrical spurious signals are displayed

Measurement Modes TIMSSOURCE

Examples :SENSe:SSource:SPURious:SFILter:STATe ON
enables the symmetrical filter, displaying only symmetrical spurious signals.

Related Commands [[:SENSe]:SSource:MEASurement

[[:SENSe]:SSource:SPURious[:THReshold]:EXCursion(?)

Sets or queries the excursion in the spurious measurement of the signal source analysis. This command has the same function as [:SENSe]:SPURious[:THReshold]:EXCursion on page 2-1112.

This command is valid when [:SENSe]:SSource:MEASurement is set to SPURious or RTSPurious.

Syntax [:SENSe]:SSource:SPURious[:THReshold]:EXCursion <value>

[:SENSe]:SSource:SPURious[:THReshold]:EXCursion?

Arguments <value>::=<NRf> specifies the excursion. Range: 0 to 30 dB (default: 3 dB)

Measurement Modes TIMSSOURCE

Examples :SENSe:SSource:SPURious:THReshold:EXCursion 5
sets the excursion to 5 dB.

Related Commands [:SENSe]:SSource:MEASurement,
[:SENSe]:SPURious[:THReshold]:EXCursion

[[:SENSe]:SSource:SPURious[:THReshold]:SPURious(?)]

Sets or queries the spurious threshold in the spurious measurement of the signal source analysis. This command has the same function as [:SENSe]:SPURious[:THReshold]:SPURious on page 2-1114.

This command is valid when [:SENSe]:SSource:MEASurement is set to SPURious or RTSPurious.

Syntax [:SENSe]:SSource:SPURious[:THReshold]:SPURious <value>

[:SENSe]:SSource:SPURious[:THReshold]:SPURious?

Arguments <value>::=<NRf> specifies the spurious threshold. Range: -90 to -30 dB.

Measurement Modes TIMSSOURCE

Examples :SENSe:SSource:SPURious:THReshold:SPURious -50
sets the spurious threshold to -50 dB.

Related Commands [:SENSe]:SSource:MEASurement,
[:SENSe]:SPURious[:THReshold]:SPURious

[:SENSE]:AC3Gpp Subgroup**W-CDMA, Option 23 Only**

The [:SENSE]:AC3Gpp commands set up the conditions related to the W-CDMA ACLR (Adjacent Channel Leakage Power Ratio) measurement.

NOTE. To use a command from this group, you must have selected SAUL3G (W-CDMA uplink analysis in the S/A mode) using the :INSTRUMENT[:SELEct] command.

Command Tree	Header	Parameter
	[:SENSE]	
	:AC3Gpp	
	:FILTer	
	:ALPHa	<numeric_value>
	:TYPE	RECTangle RNYQuist

[[:SENSe]:AC3Gpp:FILTer:ALPHa(?)]

Sets or queries the filter factor (α/BT) when you have selected RNYQuist (Root Nyquist filter) in the [[:SENSe]:AC3Gpp:FILTer:TYPE] command for the W-CDMA ACLR measurement.

Syntax [[:SENSe]:AC3Gpp:FILTer:ALPHa <value>
[[:SENSe]:AC3Gpp:FILTer:ALPHa?

Arguments <value>::=<NRf> specifies the filter factor. Range: 0 to 1.

Measurement Modes SAUL3G

Examples :SENSe:AC3Gpp:FILTer:ALPHa 0.5
sets the filter factor to 0.5.

Related Commands [[:SENSe]:AC3Gpp:FILTer:TYPE]

[[:SENSe]:AC3Gpp:FILTer:TYPE(?)]

Selects or queries the filter for the W-CDMA ACLR measurement.

Syntax [[:SENSe]:AC3Gpp:FILTer:TYPE { RECTangle | RNYQuist }
[[:SENSe]:AC3Gpp:FILTer:TYPE?

Arguments RECTangle selects the rectangular filter.
RNYQuist selects the Root Nyquist filter.

Measurement Modes SAUL3G

Examples :SENSe:AC3Gpp:FILTer:TYPE RNYQuist
selects the Root Nyquist filter.

[[:SENSE]:UL3Gpp Subgroup**W-CDMA, Option 23 Only**

The [[:SENSE]:UL3Gpp commands set up the conditions related to the W-CDMA uplink analysis.

NOTE. To use a command from this group, you must have selected *DEMUL3G* (W-CDMA uplink analysis in the Demod mode) using the *:INSTRUMENT[:SELECT]* command.

Command Tree	Header	Parameter
	[[:SENSE]	
	:UL3Gpp	
	:BLOCK	<numeric_value>
	:CARRIER	
	:OFFSET	<frequency>
	:SEARCH	<boolean>
	:FILTER	
	:ALPHA	<numeric_value>
	:MEASUREMENT	OFF RRCosine
	:REFERENCE	OFF RCOsine GAUSSian
	[[:IMMEDIATE]	
	:LENGTH	<numeric_value>
	:MMODE	DPCH PRACH PCPCh
	:OFFSET	<numeric_value>
	:SCODE	
	:NUMBER	<numeric_value>
	:TYPE	LONG SHORT
	:THRESHOLD	<relative_amplitude>

[[:SENSe]:UL3Gpp:BLOCK(?)]

Sets or queries the number of the block to measure in the W-CDMA uplink analysis.

Syntax [[:SENSe]:UL3Gpp:BLOCK <number>

[[:SENSe]:UL3Gpp:BLOCK?

Arguments <number>::=<NRf> specifies the block number. Zero represents the latest block.
Range: -M to 0 (M: Number of acquired blocks)

Measurement Modes DEMUL3G

Examples :SENSe:UL3Gpp:BLOCK -5
sets the block number to -5.

[[:SENSe]:UL3Gpp:CARRIER:OFFSET(?)]

Sets or queries the carrier frequency offset in the W-CDMA uplink analysis.

Syntax [[:SENSe]:UL3Gpp:CARRIER:OFFSET <freq>

[[:SENSe]:UL3Gpp:CARRIER:OFFSET?

Arguments <frequency>::=<NRf> specifies the carrier frequency offset.
Range: -Fs to Fs (Fs: Span)

Measurement Modes DEMUL3G

Examples :SENSe:UL3Gpp:CARRIER:OFFSET 10MHz
sets the carrier frequency offset to 10 MHz.

[[:SENSE]:UL3Gpp:CARRIER:SEARCH(?)]

Determines whether to detect the carrier automatically in the W-CDMA uplink analysis.

Syntax [[:SENSE]:UL3Gpp:CARRIER:SEARCH { OFF | ON | 0 | 1 }

[[:SENSE]:UL3Gpp:CARRIER:SEARCH?

Arguments OFF or 0 specifies that the carrier is not detected automatically. Set the carrier frequency offset using the [[:SENSE]:UL3Gpp:CARRIER:OFFSet command.

ON or 1 specifies that the carrier is detected automatically.

Measurement Modes DEMUL3G

Examples :SENSE:UL3Gpp:CARRIER:SEARCH ON
specifies that the carrier is detected automatically.

Related Commands [[:SENSE]:UL3Gpp:CARRIER:OFFSet

[[:SENSE]:UL3Gpp:FILTER:ALPHA(?)]

Sets or queries the filter factor (α/BT) for the measurement and the reference filters in the W-CDMA uplink analysis.

Syntax [[:SENSE]:UL3Gpp:FILTER:ALPHA <value>

[[:SENSE]:UL3Gpp:FILTER:ALPHA?

Arguments <value>::=<NRf> specifies the filter factor. Range: 0 to 1.

Measurement Modes DEMUL3G

Examples :SENSE:UL3Gpp:FILTER:ALPHA 0.5
sets the filter factor to 0.5.

[[:SENSe]:UL3Gpp:FILTer:MEASurement(?)]

Selects or queries the measurement filter in the W-CDMA uplink analysis.

Syntax [:SENSe]:UL3Gpp:FILTer:MEASurement { OFF | RRCosine }
 [:SENSe]:UL3Gpp:FILTer:MEASurement?

Arguments OFF specifies that no measurement filter is used.
 RRCosine selects the Root Raised Cosine filter.

Measurement Modes DEMUL3G

Examples :SENSe:UL3Gpp:FILTer:MEASurement RRCosine
 selects the Root Raised Cosine filter.

[[:SENSe]:UL3Gpp:FILTer:REFerence(?)]

Selects or queries the reference filter in the W-CDMA uplink analysis.

Syntax [:SENSe]:UL3Gpp:FILTer:REFerence { OFF | RCOSine | GAUSSian }
 [:SENSe]:UL3Gpp:FILTer:REFerence?

Arguments OFF specifies that no reference filter is used.
 RCOSine selects the Raised Cosine filter.
 GAUSSian selects the Gaussian filter.

Measurement Modes DEMUL3G

Examples :SENSe:UL3Gpp:FILTer:REFerence RCOSine
 selects the Raised Cosine filter.

[[:SENSE]:UL3Gpp[:IMMEDIATE] (No Query Form)

Runs the W-CDMA uplink analysis calculation for the acquired data.
To acquire data, use the :INITiate command.

Syntax [:SENSE]:UL3Gpp[:IMMEDIATE]

Arguments None

Measurement Modes DEMUL3G

Examples :SENSE:UL3Gpp:IMMEDIATE
runs the W-CDMA uplink analysis calculation.

Related Commands :INITiate

[[:SENSE]:UL3Gpp:LENGTH(?)

Defines or queries the range for the W-CDMA uplink analysis.

Syntax [:SENSE]:UL3Gpp:LENGTH <value>
[:SENSE]:UL3Gpp:LENGTH?

Arguments <value>::=<NRF> specifies the analysis range by the number of data points.
Range: 1 to 1024 × (Block size). To set the block size, use the [:SENSE]:BSIZE
command.

Measurement Modes DEMUL3G

Examples :SENSE:UL3Gpp:LENGTH 1000
sets the analysis range to 1000 points.

Related Commands [:SENSE]:BSIZE

[:SENSe]:UL3Gpp:MMODE(?)

Selects or queries the mobile mode for measurements in the W-CDMA uplink analysis.

Syntax [:SENSe]:UL3Gpp:MMODE { DPCH | PRACH | PCPCh }

[:SENSe]:UL3Gpp:MMODE?

Arguments DPCH selects the DPDCH/DPCCH mode.

PRACH selects the PRACH mode.

PCPCh selects the PCPCH mode.

Measurement Modes DEMUL3G

Examples :SENSe:UL3Gpp:MMODE PRACH
selects the PRACH mode.

[:SENSe]:UL3Gpp:OFFSet(?)

Sets or queries the measurement start position in the W-CDMA uplink analysis.

Syntax [:SENSe]:UL3Gpp:OFFSet <value>

[:SENSe]:UL3Gpp:OFFSet?

Arguments <value>::=<NRf> specifies the measurement start position by the number of data points. Range: 0 to $1024 \times (\text{Block size}) - 1$. To set the block size, use the [:SENSe]:BSIZE command.

Measurement Modes DEMUL3G

Examples :SENSe:UL3Gpp:OFFSet 100
sets the measurement start position to point 100.

Related Commands [:SENSe]:BSIZE

[[:SENSE]:UL3Gpp:SCODE:NUMBER(?)]

Sets or queries the scrambling code in the W-CDMA uplink analysis.

Syntax [:SENSE]:UL3Gpp:SCODE:NUMBER <value>
 [:SENSE]:UL3Gpp:SCODE:NUMBER?

Arguments <value>::=<NR1> specifies the scrambling code. Range: 0 to 16777215.

Measurement Modes DEMUL3G

Examples :SENSE:UL3Gpp:SCODE:NUMBER 3
 sets the scrambling code to 3.

[[:SENSE]:UL3Gpp:SCODE:TYPE(?)]

Selects or queries the scrambling code type when you have selected either the PRACH or PCPCH mode in the [:SENSE]:UL3Gpp:MMODE command.

Syntax [:SENSE]:UL3Gpp:SCODE:TYPE { LONG | SHORT }
 [:SENSE]:UL3Gpp:SCODE:TYPE?

Arguments LONG selects the long code.
 SHORT selects the short code.

Measurement Modes DEMUL3G

Examples :SENSE:UL3Gpp:SCODE:TYPE LONG
 selects the long code.

Related Commands [:SENSE]:UL3Gpp:MMODE

[[:SENSe]:UL3Gpp:THReshold(?)]

Sets or queries the threshold above which the input signal is determined to be a burst in the W-CDMA uplink analysis when you have selected either the PRACH or PCPCH mode in the [:SENSe]:UL3Gpp:MMODE command.

Syntax [:SENSe]:UL3Gpp:THReshold <rel_amp>
 [:SENSe]:UL3Gpp:THReshold?

Arguments <rel_amp>::=<NR1> is the threshold above which the input signal is decided to be a burst. Range: -100 to +10 dB relative to the reference level.

Measurement Modes DEMUL3G

Examples :SENSe:UL3Gpp:THReshold -10
 sets the threshold to -10 dBm for a burst decision.

Related Commands [:SENSe]:UL3Gpp:MMODE

[:SENSe]:GSMedge Subgroup**GSM/EDGE, Option 24 Only**

The [:SENSe]:GSMedge commands set up the conditions related to the GSM/EDGE analysis.

NOTE. To use a command from this group, you must have selected DEMG-SMEDGE (GSM/EDGE analysis) in the :INSTRument[:SElect] command.

Command Tree	Header	Parameter
	[:SENSe]	
	:GSMedge	
	:ABITs	142 147 148
	:BLOCk	<numeric_value>
	:BURSt	
	:INDex	<numeric_value>
	:MPOint	HWAY S14
	:RTFirst	
	:CARRier	
	:OFFSet	<numeric_value>
	:SEARCh	<boolean>
	:FILTer	
	:RCWRcosine	<boolean>
	[:IMMediate]	
	:LIMit	
	:SIGNal	<numeric_value>
	:SPURious	<numeric_value>
	:MEASurement	MCPower PVTime MACCuracy MODulation SWITChing SPURious
	:MODulation	GMSK EDGE
	:SLOT	<numeric_value>
	:STANdard	
	:BAND	GSM900 GSM1800 GSM1900
	:DIRection	UPLink DOWNlink
	:STINDEX	<numeric_value>
	:TSCode	
	:AUTO	<boolean>
	[:NUMBer]	<numeric_value>

[:SENSe] :GSMedge :ABITs (?)

Sets or queries the number of symbols for EVM calculation in the modulation accuracy measurement.

This command is valid when the measurement item is modulation accuracy (MACCuracy).

Syntax [:SENSe] :GSMedge :ABITs { 142 | 147 | 148 }
 [:SENSe] :GSMedge :ABITs?

Arguments 142 measures 142 symbols excluding the tail bits for the EDGE signal.
 147 measures 147 symbols specified for the GMSK signal.
 148 measures all symbols in a burst.

Measurement Modes DEMGSMEDGE

Examples :SENSe :GSMedge :ABITs 147
 measures 147 symbols specified for the GMSK signal.

Related Commands :CONFigure :GSMedge :MACCuracy, [:SENSe] :GSMedge :MEASurement

[:SENSe]:GSMedge:BLOCK(?)

Sets or queries the number of the block to measure in the GSM/EDGE analysis.

This command is invalid when the measurement item is spurious (SPURious).

Syntax [:SENSe]:GSMedge:BLOCK <number>

[:SENSe]:GSMedge:BLOCK?

Arguments <number>::=<NR1> specifies the block number. Zero represents the latest block.
Range: -M to 0 (M: Number of acquired blocks)

Measurement Modes DEMGSMEDGE

Examples :SENSe:GSMedge:BLOCK -5
sets the block number to -5.

Related Commands :CONFigure:GSMedge commands, [:SENSe]:GSMedge:MEASurement

[:SENSe]:GSMedge:BURSt:INDeX(?)

Sets or queries the number of the burst to measure in the GSM/EDGE analysis.

This command is invalid when the measurement item is spurious (SPURious).

Syntax [:SENSe]:GSMedge:BURSt:INDeX <number>

[:SENSe]:GSMedge:BURSt:INDeX?

Arguments <number>::=<NR1> specifies the burst number. Range: -999 to 0.
Zero (0) represents the latest burst.

Measurement Modes DEMGSMEDGE

Examples :SENSe:GSMedge:BURSt:INDeX -5
sets the burst number for measurement to -5.

Related Commands :CONFigure:GSMedge commands, [:SENSe]:GSMedge:MEASurement

[:SENSe] :GSMedge:BURSt:MP0int(?)

Defines or queries the center of the mask in the power versus time measurement.

This command is valid when the measurement item is power versus time (PVTime).

Syntax [:SENSe] :GSMedge:BURSt:MP0int { HWAY | S14 }
 [:SENSe] :GSMedge:BURSt:MP0int?

Arguments HWAY aligns the center of the mask with halfway between symbol 13 and 14 in the training sequence.

 S14 aligns the center of the mask with symbol 14 in the training sequence.

Measurement Modes DEMGSMEDGE

Examples :SENSe:GSMedge:BURSt:MP0int S14
 aligns the center of the mask with symbol 14 in the training sequence.

Related Commands :CONFigure:GSMedge:PVTime, [:SENSe] :GSMedge:MEASurement

[:SENSe] :GSMedge:BURSt:RTFirst (No Query Form)

Selects the first burst of all the acquired data in the GSM/EDGE analysis.

This command is invalid when the measurement item is spurious (SPURious).

Syntax [:SENSe] :GSMedge:BURSt:RTFirst

Arguments None

Measurement Modes DEMGSMEDGE

Examples [:SENSe] :GSMedge:BURSt:RTFirst
 selects the first burst of all the acquired data in the GSM/EDGE analysis.

Related Commands :CONFigure:GSMedge commands, [:SENSe] :GSMedge:MEASurement

[[:SENSe]:GSMedge:CARRier:OFFSet(?)

Sets or queries the carrier frequency offset in the GSM/EDGE analysis.

This command is valid when [[:SENSe]:GSMedge:CARRier:SEARch is OFF.

Syntax [[:SENSe]:GSMedge:CARRier:OFFSet <freq>

[[:SENSe]:GSMedge:CARRier:OFFSet?

Arguments <frequency>::=<NR1> specifies the carrier frequency offset relative to the center frequency. Range: -(span) to +(span).

Measurement Modes DEMGSMEDGE

Examples :SENSe:GSMedge:CARRier:OFFSet 10MHz
sets the carrier frequency offset to 10 MHz.

Related Commands [[:SENSe]:GSMedge:CARRier:SEARch

[[:SENSe]:GSMedge:CARRier:SEARch(?)

Selects or queries whether to detect the carrier automatically in the GSM/EDGE analysis.

This command is invalid when the measurement item is switching spectrum (SWITching) and spurious (SPURious).

Syntax [:SENSe]:GSMedge:CARRier:SEARch { OFF | ON | 0 | 1 }
[:SENSe]:GSMedge:CARRier:SEARch?

Arguments OFF or 0 specifies that the carrier is not detected automatically. To set the carrier frequency offset, use the [:SENSe]:GSMedge:CARRier:OFFSet command.

ON or 1 specifies that the carrier is detected automatically.

Measurement Modes DEMGSMEDGE

Examples :SENSe:GSMedge:CARRier:SEARch ON
specifies that the carrier is detected automatically.

Related Commands :CONFigure:GSMedge commands, [:SENSe]:GSMedge:CARRier:OFFSet,
[:SENSe]:GSMedge:MEASurement

[[:SENSE]:GSMedge:FILTer:RCWRcosine(?)]

Determines whether to enable or disable the RCW (Raised Cosine Windowed) Raised Cosine filter in the modulation accuracy measurement.

This command is valid when the measurement item is modulation accuracy (MACCuracy).

Syntax [:SENSE]:GSMedge:FILTer:RCWRcosine { OFF | ON | 0 | 1 }
[:SENSE]:GSMedge:FILTer:RCWRcosine?

Arguments OFF or 0 disables the RCW Raised Cosine filter.
ON or 1 enables the RCW Raised Cosine filter.

Measurement Modes DEMGSMEDGE

Examples :SENSE:GSMedge:FILTer:RCWRcosine ON
enables the RCW Raised Cosine filter.

Related Commands :CONFigure:GSMedge:MACCuracy, [:SENSE]:GSMedge:MEASurement

[[:SENSE]:GSMedge[:IMMEDIATE] (No Query Form)]

Performs calculation for the acquired data in the GSM/EDGE analysis.

Syntax [:SENSE]:GSMedge[:IMMEDIATE]

Arguments None

Measurement Modes DEMGSMEDGE

Examples :SENSE:GSMedge:IMMEDIATE
performs calculation for the acquired data.

Related Commands :INITiate

[[:SENSe]:GSMedge:LIMit:SIGNal(?)]

Sets or queries a threshold to determine a normal signal in the GSM/EDGE spurious measurement.

This command is valid when the measurement item is spurious (SPURious).

Syntax [[:SENSe]:GSMedge:LIMit:SIGNal <value>

[[:SENSe]:GSMedge:LIMit:SIGNal?

Arguments <value>::=<NRF> specifies the threshold to determine a normal signal. The signal that exceeds the threshold is regarded as the normal signal.
Range: -100 to +30 dBm.

Measurement Modes DEMGSMEDGE

Examples :SENSe:GSMedge:LIMit:SIGNal -20
sets the threshold to -20 dBm.

Related Commands :CONFigure:GSMedge:SPURious, [[:SENSe]:GSMedge:MEASurement

[[:SENSe]:GSMedge:LIMit:SPURious(?)

Sets or queries a threshold to determine a spurious signal in the GSM/EDGE spurious measurement.

This command is valid when the measurement item is spurious (SPURious).

Syntax [:SENSe]:GSMedge:LIMit:SPURious <value>

[:SENSe]:GSMedge:LIMit:SPURious?

Arguments <value>::=<Nrf> specifies the threshold to determine a spurious signal. The signal that exceeds the threshold is regarded as the spurious signal.
Range: -150 to 0 dBm.

Measurement Modes DEMGSMEDGE

Examples :SENSe:GSMedge:LIMit:SPURious -30
sets the threshold to -30 dBm.

Related Commands :CONFigure:GSMedge:SPURious, [:SENSe]:GSMedge:MEASurement

[[:SENSe]:GSMedge:MEASurement(?)

Selects or queries the measurement item in the GSM/EDGE analysis.

Syntax `[[:SENSe]:GSMedge:MEASurement { MCPower | PVTime | MACCuracy
| MODulation | SWITching | SPURious }`

`[[:SENSe]:GSMedge:MEASurement?`

Arguments Table 2-107 shows the arguments and their meanings.

Table 2- 107: GSM/EDGE measurement items

Argument	Measurement item
MCPower	Mean carrier power
PVTime	Power versus Time
MACCuracy	Modulation accuracy
MODulation	Modulation spectrum
SWITching	Switching spectrum
SPURious	Inband spurious

Measurement Modes DEMGSMEDGE

Examples `SENSe:GSMedge:MEASurement MCPower`
selects the mean carrier power measurement.

[[:SENSe]:GSMedge:MODulation(?)

Selects or queries the modulation system in the GSM/EDGE analysis.

This command is invalid when the measurement item is spurious (SPURious).

Syntax [:SENSe]:GSMedge:MODulation { GMSK | EDGE }
 [:SENSe]:GSMedge:MODulation?

Arguments GMSK selects GMSK (Gaussian Minimum Shift Keying).
 EDGE selects EDGE (Enhanced Data rates for GSM Evolution).

Measurement Modes DEMGSMEDGE

Examples :SENSe:GSMedge:MODulation EDGE
 selects the EDGE modulation.

Related Commands :CONFigure:GSMedge commands, [:SENSe]:GSMedge:MEASurement

[[:SENSe]:GSMedge:SLOT(?)

Sets or queries the number of slots per block. Waveform data is acquired in the block unit.

This command is invalid when the measurement item is spurious (SPURious).

Syntax [:SENSe]:GSMedge:SLOT <value>
 [:SENSe]:GSMedge:SLOT?

Arguments <value>::=<NRf> specifies the number of slots per block. Range: 1 to 65535

Measurement Modes DEMGSMEDGE

Examples :SENSe:GSMedge:SLOT 100
 sets one block to 100 slots.

Related Commands :CONFigure:GSMedge commands, [:SENSe]:BSIZE,
 [:SENSe]:GSMedge:MEASurement

[[:SENSe]:GSMedge:STANdard:BAND(?)

Selects or queries the GSM/EDGE standard.

NOTE. *No query in the GSM/EDGE spurious measurement.*

Syntax [:SENSe]:GSMedge:STANdard:BAND { GSM850 | GSM900 | GSM1800
 | GSM1900 }

 [:SENSe]:GSMedge:STANdard:BAND?

Arguments GSM850 selects the GSM850 standard.

 GSM900 selects the GSM900 standard.

 DCS1800 selects the DCS1800 standard.

 PCS1900 selects the PCS1900 standard.

Measurement Modes DEMGSMEDGE

Examples :SENSe:GSMedge:STANdard:BAND PCS1900
 selects the PCS1900 standard.

[:SENSe] :GSMedge :STANdard :DIRection (?)

Selects or queries the link direction in the GSM/EDGE analysis.

NOTE. No query in the GSM/EDGE spurious measurement.

Syntax [:SENSe] :GSMedge :STANdard :DIRection { UPLink | DOWNlink }
[:SENSe] :GSMedge :STANdard :DIRection ?

Arguments UPLink selects uplink.
DOWNlink selects downlink.

Measurement Modes DEMGSMEDGE

Examples :SENSe :GSMedge :STANdard :DIRection DOWNlink
selects downlink in the GSM/EDGE analysis.

[:SENSe] :GSMedge :STINdex (?)

Sets or queries the column number of the spurious table in the spurious measurement. The specified column is highlighted.

This command is valid when the measurement item is spurious (SPURious).

Syntax [:SENSe] :GSMedge :STINdex <number>
[:SENSe] :GSMedge :STINdex ?

Arguments <number>::=<NRf> specifies the column number of the spurious table.
Range: 1 to 10.

Measurement Modes DEMGSMEDGE

Examples :SENSe :GSMedge :STINdex 3
specifies column 3 in the spurious table.

Related Commands :CONFigure :GSMedge :SPURious, [:SENSe] :GSMedge :MEASurement

[[:SENSe]:GSMedge:TSCode:AUTO(?)]

Determines whether to set the training sequence code (TSC) automatically in the GSM/EDGE analysis.

Syntax `[[:SENSe]:GSMedge:TSCode:AUTO { OFF | ON | 0 | 1 }`

`[[:SENSe]:GSMedge:TSCode:AUTO?`

Arguments OFF or 0 specifies that TSC is not set automatically. To set it, use the `[[:SENSe]:GSMedge:TSCode[:NUMBER]` command.

ON or 1 specifies that TSC is set automatically.

Measurement Modes DEMGSMEDGE

Examples `:SENSe:GSMedge:TSCode:AUTO ON`
sets TSC automatically.

Related Commands `[[:SENSe]:GSMedge:TSCode[:NUMBER]`

[[:SENSe]:GSMedge:TSCode[:NUMBER](?)

Sets or queries the training sequence code (TSC) number in the GSM/EDGE analysis.

This command is valid when `[[:SENSe]:GSMedge:TSCode:AUTO` is OFF.

Syntax `[[:SENSe]:GSMedge:TSCode[:NUMBER] <number>`

`[[:SENSe]:GSMedge:TSCode[:NUMBER]?`

Arguments `<number>::=<NR1>` specifies the TSC number. Range: 0 to 7

Measurement Modes DEMGSMEDGE

Examples `:SENSe:GSMedge:TSCode:NUMBER 7`
sets the TSC number to 7.

Related Commands `[[:SENSe]:GSMedge:TSCode:AUTO`

[[:SENSE]:FLCDMA2K]:RLCDMA2K Subgroup**cdma2000, Option 25 Only**

The [[:SENSE]:FLCDMA2K]:RLCDMA2K commands set up the conditions related to the cdma2000 forward or reverse link analysis.

NOTE. To use a command from this group, you must have selected DEMFLCDMA2K (cdma2000 forward link analysis) or DEMRLCDMA2K (cdma2000 reverse link analysis) using the :INSTRUMENT[:SELECT] command.

Command Tree	Header	Parameter
	[[:SENSE]	
	:FLCDMA2K :RLCDMA2K	
	:ACQuisition	
	:CHIPs	<numeric_value>
	:HISTory	<numeric_value>
	:SEConds	<numeric_value>
	:ANALysis	
	:INTerval	<numeric_value>
	:OFFSet	<numeric_value>
	:BLOCK	<numeric_value>
	[:IMMediate]	
	:MEASurement	CHPower ACPower IM SEMask CDPower MACCuracy CCDF PVTime PCCHannel OBWidth OFF
	:SPECTrum	
	:OFFSet	<numeric_value>
	:TINTerval	

[[:SENSe]:FLCDMA2K]:RLCDMA2K:ACQuisition:CHIPs(?)

Sets or queries the acquisition length in chips.

Syntax [:SENSe]:FLCDMA2K]:RLCDMA2K:ACQuisition:CHIPs <value>
 [:SENSe]:FLCDMA2K]:RLCDMA2K:ACQuisition:CHIPs?

Arguments <value>::=<NR1> specifies the acquisition length in chips. The setting range depends on span and memory length. The minimum value is 6144.

Measurement Modes DEMFLCDMA2K, DEMRLCDMA2K

Examples :SENSe:FLCDMA2K:ACQuisition:CHIPs 10240
 sets the acquisition length in chips to 10240 in the cdma2000 forward link analysis.

[[:SENSe]:FLCDMA2K]:RLCDMA2K:ACQuisition:HISTory(?)

Sets or queries the acquisition history. The acquisition can be viewed as it is selected, and can be reanalyzed after the selection.

Syntax [:SENSe]:FLCDMA2K]:RLCDMA2K:ACQuisition:HISTory <value>
 [:SENSe]:FLCDMA2K]:RLCDMA2K:ACQuisition:HISTory?

Arguments <value>::=<NR1> specifies the acquisition history. Zero represents the latest. The setting range depends on span and memory length.

Measurement Modes DEMFLCDMA2K, DEMRLCDMA2K

Examples :SENSe:FLCDMA2K:ACQuisition:HISTory 0
 sets the acquisition history to 0 in the cdma2000 forward link analysis.

[[:SENSE]:FLCDMA2K]:RLCDMA2K:ACQuisition:SEConds(?)

Sets or queries the acquisition length in seconds.

Syntax [:SENSE]:FLCDMA2K|:RLCDMA2K:ACQuisition:SEConds <value>
 [:SENSE]:FLCDMA2K|:RLCDMA2K:ACQuisition:SEConds?

Arguments <value>::=<NRf> specifies the acquisition length in seconds.
 Range: 4.998 ms to no logical limitation (depends on Span and memory length).

Measurement Modes DEMFLCDMA2K, DEMRLCDMA2K

Examples :SENSE:FLCDMA2K:ACQuisition:SEConds 9.163ms
 sets the acquisition length in seconds to 9.163 ms in the cdma2000 forward link analysis.

[[:SENSe]:FLCDMA2K|RLCDMA2K:ANALysis:INTerval(?)

Sets or queries the analysis interval in chips.

Syntax [:SENSe]:FLCDMA2K|RLCDMA2K:ANALysis:INTerval <value>
 [:SENSe]:FLCDMA2K|RLCDMA2K:ANALysis:INTerval?

Arguments <value>::=<NR1> specifies the analysis interval in chips.
 The range depends on the acquisition length setting.

Measurement Modes DEMFLCDMA2K, DEMRLCDMA2K

Examples :SENSe:FLCDMA2K:ANALysis:INTerval 3072
 sets the analysis interval in chips to 3072 in the cdma2000 forward link analysis.

[[:SENSe]:FLCDMA2K|RLCDMA2K:ANALysis:OFFSet(?)

Sets or queries the analysis offset (the start point of the analysis range) in chips.

Syntax [:SENSe]:FLCDMA2K|RLCDMA2K:ANALysis:OFFSet <value>
 [:SENSe]:FLCDMA2K|RLCDMA2K:ANALysis:OFFSet?

Arguments <value>::=<NR1> specifies the analysis offset in chips.
 Range: 0 to 12582912 chips.

Measurement Modes DEMFLCDMA2K, DEMRLCDMA2K

Examples :SENSe:FLCDMA2K:ANALysis:OFFSet 512
 sets the analysis offset in chips to 512 in the cdma2000 forward link analysis.

[:SENSe]:FLCDMA2K]:RLCDMA2K:BLOCK(?)

Sets or queries the number of the block to measure in the cdma2000 forward or reverse link analysis.

Syntax [:SENSe]:FLCDMA2K|RLCDMA2K:BLOCK <value>

[:SENSe]:FLCDMA2K|RLCDMA2K:BLOCK?

Arguments <value>: :=<NR1> specifies the block number. Zero represents the latest block. Range: -M to 0 (M: number of acquired blocks).

Measurement Modes DEMFLCDMA2K, DEMRLCDMA2K

Examples :SENSe:FLCDMA2K:BLOCK -5
sets the block number to -5 in the cdma2000 forward link analysis.

[:SENSe]:FLCDMA2K]:RLCDMA2K[:IMMEDIATE] (No Query Form)

Performs calculation for the acquired data in the cdma2000 forward or reverse link analysis.

Syntax [:SENSe]:FLCDMA2K|RLCDMA2K[:IMMEDIATE]

Arguments None

Measurement Modes DEMFLCDMA2K, DEMRLCDMA2K

Examples :SENSe:FLCDMA2K:IMMEDIATE
performs calculation for the acquired data in the cdma2000 forward link analysis.

[:SENSe]:FLCDMA2K|RLCDMA2K:MEASurement(?)

Selects or queries the measurement item for the cdma2000 forward or reverse link analysis.

Syntax [:SENSe]:FLCDMA2K|RLCDMA2K:MEASurement { CHPower | ACPower | IM | SEMask | CDPower | MACCuracy | CCDF | PVTime | PCCHannel | OBWidth | OFF }

[:SENSe]:FLCDMA2K|RLCDMA2K:MEASurement?

Arguments Table 2-108 shows the measurement item selections in the cdma2000 analysis.

Table 2-108: Measurement item selections

Argument	Measurement item
CHPower	Channel power measurement
ACPower	ACPR measurement
IM	Intermodulation measurement
SEMask	Spectrum emission mask measurement
CDPower	Code domain power measurement
MACCuracy	Modulation accuracy measurement
CCDF	CCDF measurement
PVTime ¹	Gated output power measurement
PCCHannel	Pilot to code channel measurement
OBWidth	Occupied bandwidth measurement
OFF	Measurement OFF

¹ Available in the RLC DMA2K mode only.

Measurement Modes DEMFLCDMA2K, DEMRLCDMA2K

Examples :SENSe:FLCDMA2K:MEASurement CCDF
selects the CCDF measurement for the cdma2000 forward link analysis.

[[:SENSE]:FLCDMA2K]:RLCDMA2K:SPECTrum:OFFSet(?)

Sets or queries the spectrum offset within the time window in the cdma2000 forward or reverse link analysis.

Syntax [[:SENSE]:FLCDMA2K|RLCDMA2K:SPECTrum:OFFSet <value>

[[:SENSE]:FLCDMA2K|RLCDMA2K:SPECTrum:OFFSet?

Arguments <value>: :=<NRf> specifies the spectrum offset within the time windows.
Range: 0 ms to 26.56 ms.

Measurement Modes DEMFLCDMA2K, DEMRLCDMA2K

Examples :SENSE:FLCDMA2K:SPECTrum:OFFSet 10ms
sets the spectrum offset within the time window to 10 ms in the cdma2000 forward link analysis.

[[:SENSE]:FLCDMA2K]:RLCDMA2K:SPECTrum:TINTerval? (Query Only)

Queries the length of the time-domain information used to construct the spectrum trace in the cdma2000 forward or reverse link analysis.

Syntax [[:SENSE]:FLCDMA2K|RLCDMA2K:SPECTrum:TINTerval?

Arguments None

Measurement Modes DEMFLCDMA2K, DEMRLCDMA2K

Examples :SENSE:FLCDMA2K:SPECTrum:TINTerval?
returns the length of the time-domain information in the cdma2000 forward link analysis.

[:SENSe]:FLCDMA2K[:RLCDMA2K]:ACPower Subgroup

cdma2000, Option 25 Only

The [:SENSe]:FLCDMA2K[:RLCDMA2K]:ACPower commands set up the conditions related to the ACPR measurement in the cdma2000 forward or reverse link analysis.

NOTE. To use a command from this group, you must have selected DEMFLCDMA2K (cdma2000 forward link analysis) or DEMRLCDMA2K (cdma2000 reverse link analysis) using the :INSTRument[:SElect] command.

Command Tree	Header	Parameter
	[:SENSe]	
	:FLCDMA2K[:RLCDMA2K]	
	:ACPower	
	:BANDwidth[:BWIDth]	
	:INTEgration	<numeric_value>
	:FILTer	
	:COEFFicient	<numeric_value>
	:TYPE	RECTangle GAUSSian NYQuist RNYQuist
	:LIMit	
	:ADJacent<x>	
	[:STATE]	<boolean>

[[:SENSE]:FLCDMA2K]:RLCDMA2K:ACPower:BANDwidth]:BWIDth:INTegration(?)

Sets or queries the bandwidth of the main channel for the ACPR measurement in the cdma2000 forward or reverse link analysis.

Syntax [[:SENSE]:FLCDMA2K]:RLCDMA2K:ACPower:BANDwidth]:BWIDth:INTegration <value>

[[:SENSE]:FLCDMA2K]:RLCDMA2K:ACPower:BANDwidth]:BWIDth:INTegration?

Arguments <value>::=<NRf> specifies the bandwidth of the main channel for the ACPR measurement. Range: Span/20 to full span [Hz].

Measurement Modes DEMFLCDMA2K, DEMRLCDMA2K

Examples :SENSE:FLCDMA2K:ACPower:BANDwidth:INTegration 2.5MHz
sets the bandwidth of the main channel to 2.5 MHz in the cdma2000 forward link analysis.

[[:SENSE]:FLCDMA2K]:RLCDMA2K:ACPower:FILTer:COEFFicient(?)

Sets or queries the filter roll-off rate for the ACPR measurement in the cdma2000 forward or reverse link analysis.

Syntax [[:SENSE]:FLCDMA2K]:RLCDMA2K:ACPower:FILTer:COEFFicient <value>

[[:SENSE]:FLCDMA2K]:RLCDMA2K:ACPower:FILTer:COEFFicient?

Arguments <value>::=<NRf> specifies the roll-off rate. Range: 0 to 1.

Measurement Modes DEMFLCDMA2K, DEMRLCDMA2K

Examples :SENSE:FLCDMA2K:ACPower:FILTer:COEFFicient 0.5
sets the filter roll-off rate for the ACPR measurement to 0.5 in the cdma2000 forward link analysis.

[[:SENSe]:FLCDMA2K]:RLCDMA2K:ACPower:FILTER:TYPE(?)

Select or queries the filter for the ACPR measurement in the cdma2000 forward or reverse link analysis.

Syntax [:SENSe]:FLCDMA2K]:RLCDMA2K:ACPower:FILTER:TYPE { RECTangle
 | GAUSSian | NYQuist | RNYQuist }

[:SENSe]:FLCDMA2K]:RLCDMA2K:ACPower:FILTER:TYPE?

Arguments RECTangle selects the rectangular filter.

 GAUSSian selects the Gaussian filter.

 NYQuist selects the Nyquist filter.

 RNYQuist selects the Root Nyquist filter.

Measurement Modes DEMFLCDMA2K, DEMRLCDMA2K

Examples :SENSe:FLCDMA2K:ACPower:FILTER:TYPE NYQuist
 selects the Nyquist filter for the ACPR measurement in the cdma2000 forward
 link analysis.

[[:SENSE]:FLCDMA2K]:RLCDMA2K:ACPower:LIMit:ADJacent<x>[:STATE](?)

Sets or queries whether to enable or disable the adjacent limit testing for the ACPR measurement in the cdma2000 forward or reverse link analysis.

Syntax [[:SENSE]:FLCDMA2K]:RLCDMA2K:ACPower:LIMit:ADJacent<x>[:STATE]
{ ON | OFF | 1 | 0 }

[[:SENSE]:FLCDMA2K]:RLCDMA2K:ACPower:LIMit:ADJacent<x>[:STATE]?

Where

ADJacent<x> (x=1 to 12) represents the xth adjacent.

Arguments ON or 1 enables the adjacent limit testing.

OFF or 0 disables the adjacent limit testing.

Measurement Modes DEMFLCDMA2K, DEMRLCDMA2K

Examples :SENSE:FLCDMA2K:ACPower:LIMit:ADJacent1 ON
enables the first adjacent limit testing for the ACPR measurement in the cdma2000 forward link analysis.

[[:SENSe]:FLCDMA2K]:RLCDMA2K:CCDF Subgroup

cdma2000, Option 25 Only

The [[:SENSe]:FLCDMA2K]:RLCDMA2K:CCDF commands set up the conditions related to the CCDF measurement in the cdma2000 forward or reverse link analysis.

NOTE. To use a command from this group, you must have selected DEMFLCDMA2K (cdma2000 forward link analysis) or DEMRLCDMA2K (cdma2000 reverse link analysis) using the :INSTRument[:SElect] command.

Command Tree

Header	Parameter
[[:SENSe]	
:FLCDMA2K :RLCDMA2K	
:CCDF	
:RMEasurement	
:THReshold	<numeric_value>

[[:SENSe]:FLCDMA2K]:RLCDMA2K:CCDF:RMEasurement (No Query Form)

Clears the CCDF accumulator and restarts the measurement.

Syntax [[:SENSe]:FLCDMA2K]:RLCDMA2K:CCDF:RMEasurement

Arguments None

Measurement Modes DEMFLCDMA2K, DEMRLCDMA2K

Examples :SENSe:FLCDMA2K:CCDF:RMEasurement
clears the CCDF accumulator and restart the measurement for the CCDF measurement in the cdma2000 forward link analysis.

[[:SENSe]:FLCDMA2K]:RLCDMA2K:CCDF:THReshold(?)

Sets or queries the threshold for the CCDF measurement in the cdma2000 forward or reverse link analysis.

Syntax [[:SENSe]:FLCDMA2K]:RLCDMA2K:CCDF:THReshold <value>
[[:SENSe]:FLCDMA2K]:RLCDMA2K:CCDF:THReshold?

Arguments <value>::=<NRf> specifies the threshold for the CCDF measurement.
Range: -250 dBm to 130 dBm.

Measurement Modes DEMFLCDMA2K, DEMRLCDMA2K

Examples :SENSe:FLCDMA2K:CCDF:THReshold -100dBm
sets the threshold for the CCDF measurement to -100 dBm in the cdma2000 forward link analysis.

[[:SENSe]:FLCDMA2K]:RLCDMA2K:CDPower Subgroup*cdma2000, Option 25 Only*

The [[:SENSe]:FLCDMA2K]:RLCDMA2K:CDPower commands set up the conditions related to the code domain power measurement in the cdma2000 forward or reverse link analysis.

NOTE. To use a command from this group, you must have selected DEMFLCDMA2K (cdma2000 forward link analysis) or DEMRLCDMA2K (cdma2000 reverse link analysis) using the :INSTRument[:SElect] command.

Command Tree

Header	Parameter
[[:SENSe]	
:FLCDMA2K :RLCDMA2K	
:CDPower	
:ACThreshold	<numeric_value>
:FILTer	
:MEASurement	OFF EQComp COMP
:IQSWap	<boolean>
:MLEVe1	CHIP SYMBol
:PNOffset	<numeric_value>
:QOF	<numeric_value>
:RCONfig	<string>
:SElect	
:CODE	<numeric_value>
:PCG	<numeric_value>
:WCODe	COMPOSITE W2L W4L W8L W16L W32L W64L W128L

[[:SENSe]:FLCDMA2K]:RLCDMA2K:CDPower:ACCThreshold(?)

Sets or queries the active channel threshold level (in dB from the pilot), which is used for deciding whether a code channel is active or inactive, for the code domain power measurement in the cdma2000 forward or reverse link analysis.

Syntax [[:SENSe]:FLCDMA2K|RLCDMA2K:CDPower:ACCThreshold <value>
[[:SENSe]:FLCDMA2K|RLCDMA2K:CDPower:ACCThreshold?

Arguments <value>::=<NRf> specifies the active channel threshold level.
Range: -50 dB to 50 dB.

Measurement Modes DEMFLCDMA2K, DEMRLCDMA2K

Examples :SENSe:FLCDMA2K:CDPower:ACCThreshold -27dB
sets the active channel threshold level to -27 dB for the code domain power measurement in the cdma2000 forward link analysis.

[[:SENSe]:FLCDMA2K]:RLCDMA2K:CDPower:FILTer:MEASurement(?)

Selects or queries the measurement filter for the code domain power measurement in the cdma2000 forward or reverse link analysis.

Syntax [[:SENSe]:FLCDMA2K|RLCDMA2K:CDPower:FILTer:MEASurement { OFF
| EQComp | COMP }
[[:SENSe]:FLCDMA2K|RLCDMA2K:CDPower:FILTer:MEASurement?

Arguments OFF specifies that no measurement filter is used.
EQComp selects the complementary filter and EQ (equalizer).
COMP selects the complementary filter.

Measurement Modes DEMFLCDMA2K, DEMRLCDMA2K

Examples :SENSe:FLCDMA2K:CDPower:FILTer:MEASurement COMP
selects the complementary filter for the code domain power measurement in the cdma2000 forward link analysis.

[[:SENSe]:FLCDMA2K]:RLCDMA2K:CDPower:IQSWap(?)

Sets or queries whether to enable or disable IQ swapping for the code domain power measurement in the cdma2000 forward or reverse link analysis.

Syntax [:SENSe]:FLCDMA2K|RLCDMA2K:CDPower:IQSWap { ON | OFF | 1 | 0 }
[:SENSe]:FLCDMA2K|RLCDMA2K:CDPower:IQSWap?

Arguments ON or 1 enables the IQ swapping.
OFF or 0 disables the IQ swapping.

Measurement Modes DEMFLCDMA2K, DEMRLCDMA2K

Examples :SENSe:FLCDMA2K:CDPower:IQSWap ON
sets the IQ swapping to ON for the code domain power measurement in the cdma2000 forward link analysis.

[[:SENSe]:dFLCDMA2K]:RLCDMA2K:CDPower:MLEVel(?)

Sets or queries the measurement level for the code domain power measurement in the cdma2000 forward or reverse link analysis. This command is available when :DISPlay:FLCDMA2K]:RLCDMA2K:DDEMod:MVew:FORMat is IQPower.

Syntax [:SENSe]:FLCDMA2K]:RLCDMA2K:CDPower:MLEVel { CHIP | SYMBol }
[:SENSe]:FLCDMA2K]:RLCDMA2K:CDPower:MLEVel?

Arguments CHIP sets the measurement level to chip.
SYMBol sets the measurement level to symbol.

Measurement Modes DEMFLCDMA2K, DEMRLCDMA2K

Examples :SENSe:FLCDMA2K:CDPower:MLEVel CHIP
sets the measurement level to chip for the code domain power measurement in the cdma2000 forward link analysis.

Related Commands :DISPlay:FLCDMA2K]:RLCDMA2K:DDEMod:MVew:FORMat

[[:SENSE]:FLCDMA2K:CDPower:PNOffset(?)]

Sets or queries the PN offset for the code domain power measurement in the cdma2000 forward link analysis.

Syntax [:SENSE]:FLCDMA2K:CDPower:PNOffset <value>

 [:SENSE]:FLCDMA2K:CDPower:PNOffset?

Arguments <value>::=<NR1> specifies the PN offset in the unit of 64 chips.
Range: 0 to 511.

Measurement Modes DEMFLCDMA2K

Examples :SENSE:FLCDMA2K:CDPower:PNOffset 100
sets the PN offset to 100 for the code domain power measurement in the cdma2000 forward link analysis.

[[:SENSe]:FLCDMA2K:CDPower:QOF(?)

Sets or queries the Walsh code quasi-orthogonal function for the code domain power measurement in the cdma2000 forward link analysis. This command is only available when :DISPlay:FL1XEVD0|:RL1XEVD0:DDEMod:MV1ew:FORMat is CDPower or PCGRam and [[:SENSe]:FL1XEVD0|:RL1XEVD0:CDPower:MLEVel is SYMBol.

Syntax [[:SENSe]:FLCDMA2K:CDPower:QOF <value>
 [[:SENSe]:FLCDMA2K:CDPower:QOF?

Arguments <value>::=<NR1> specifies the Walsh code quasi-orthogonal function.
 Range: 0 to 3.

Measurement Modes DEMFLCDMA2K

Examples :SENSe:FLCDMA2K:CDPower:QOF 1
 sets the Walsh code quasi-orthogonal function to 1 for the code domain power measurement in the cdma2000 forward link analysis.

Related Commands :DISPlay:FLCDMA2K|:RLCDMA2K:DDEMod:MV1ew:FORMat,
 [[:SENSe]:FLCDMA2K|:RLCDMA2K:CDPower:MLEVel

[[:SENSE]:FLCDMA2K]:RLCDMA2K:CDPower:RCONfig(?)

Selects or queries the available radio configuration for the code domain power measurement in the cdma2000 forward or reverse link analysis.

Syntax [:SENSE]:FLCDMA2K|:RLCDMA2K:CDPower:RCONfig
 { "CDMAONE" | "CDMA2K1X" }

 [:SENSE]:FLCDMA2K|:RLCDMA2K:CDPower:RCONfig?

Arguments "CDMAONE" selects RC1/RC2 for FLCDMA2K.

 "CDMA2K1X" selects RC3/RC4/RC5 for FLCDMA2K and RC3/RC4 for
 RLCDMA2K.

Measurement Modes DEMFLCDMA2K

Examples :SENSE:FLCDMA2K:CDPower:RCONfig "CDMAONE"
 sets the radio configuration to RC1/RC2 for the code domain power measure-
 ment in the cdma2000 forward link analysis.

[[:SENSe]:FLCDMA2K]:RLCDMA2K:CDPower:SElect:CODE(?)

Sets or queries the code in the PCG for the code domain power measurement in the cdma2000 forward or reverse link analysis. This command is valid when :DISPlay:FLCDMA2K]:RLCDMA2K:DDEMod:MVIEw:FORMat is IQPower, CDPower, or PCGram. For IQPower, when [[:SENSe]:FLCDMA2K]:RLCDMA2K:CDPower:MLEVel is CHIP, the argument value is fixed to 0.

Syntax [[:SENSe]:FLCDMA2K]:RLCDMA2K:CDPower:SElect:CODE <value>
[[:SENSe]:FLCDMA2K]:RLCDMA2K:CDPower:SElect:CODE?

Arguments <value>::=<NR1> specifies the code in the PCG. The available ranges are shown in Table 2-109.

Table 2-109: Code range

Standard	RCONfig ¹	Range
FLCDMA2K	CDMAONE	64 fixed
	CDMA2K1X	4 to 128
RLCDMA2K	CDMA2K1X	2 to 64

¹ The [[:SENSe]:FLCDMA2K]:RLCDMA2K:CDPower:RCONfig command setting.

Measurement Modes DEMFLCDMA2K, DEMRLCDMA2K

Examples :SENSe:FLCDMA2K:CDPower:SElect:CODE 30
sets the code in the PCG to 30 for the code domain power measurement in the cdma2000 forward link analysis.

Related Commands :DISPlay:FLCDMA2K]:RLCDMA2K:DDEMod:MVIEw:FORMat,
[[:SENSe]:FLCDMA2K]:RLCDMA2K:CDPower:MLEVel,
[[:SENSe]:FLCDMA2K]:RLCDMA2K:CDPower:RCONfig

[[:SENSe]:FLCDMA2K]:RLCDMA2K:CDPower:SElect:PCG(?)

Sets or queries the PCG (power control group) for the code domain power measurement in the cdma2000 forward or reverse link analysis.

Syntax [[:SENSe]:FLCDMA2K]:RLCDMA2K:CDPower:SElect:PCG <value>

[[:SENSe]:FLCDMA2K]:RLCDMA2K:CDPower:SElect:PCG?

Arguments <value>::=<NR1> specifies the PCG.
Range: -(number of analyzed chips - 1) to 0.

Measurement Modes DEMFLCDMA2K, DEMRLCDMA2K

Examples :SENSe:FLCDMA2K:CDPower:SElect:PCG -10
sets the PCG to -10 for the code domain power measurement in the cdma2000 forward link analysis.

[[:SENSe]:FLCDMA2K]:RLCDMA2K:CDPower:WCODe(?)

Selects or queries the Walsh code length for the code domain power measurement in the cdma2000 forward or reverse link analysis. This command is valid when [[:SENSe]:FLCDMA2K]:RLCDMA2K:CDPower:RCONfig is CDMA2K1X.

Syntax [[:SENSe]:FLCDMA2K]:RLCDMA2K:CDPower:WCODe { COMPOSITE | W2L | W4L | W8L | W16L | W32L | W64L | W128L }

[[:SENSe]:FLCDMA2K]:RLCDMA2K:CDPower:WCODe?

Arguments Table 2-110 shows the Walsh code length selections.

Table 2-110: Walsh code length selections

Argument	Length
COMPOSITE	Composite
W2L ¹	2
W4L	4
W8L	8
W16L	16
W32L	32
W64L	64
W128L ²	128

¹ For the RLCDMA2K standard only.

² For the FLCDMA2K standard only.

Measurement Modes DEMFLCDMA2K, DEMRLCDMA2K

Examples :SENSe:FLCDMA2K:CDPower:WCODe W4L
sets the Walsh code length to 4 for the code domain power measurement in the cdma2000 forward link analysis.

Related Commands [[:SENSe]:FLCDMA2K]:RLCDMA2K:CDPower:RCONfig

[[:SENSE]:FLCDMA2K]:RLCDMA2K:CHPower Subgroup**cdma2000, Option 25 Only**

The [[:SENSE]:FLCDMA2K]:RLCDMA2K:CHPower commands set up the conditions related to the channel power measurement in the cdma2000 forward or reverse link analysis.

NOTE. To use a command from this group, you must have selected DEMFLCDMA2K (cdma2000 forward link analysis) or DEMRLCDMA2K (cdma2000 reverse link analysis) using the :INSTRument[:SElect] command.

Command Tree	Header	Parameter
	[[:SENSE]	
	:FLCDMA2K :RLCDMA2K	
	:CHPower	
	:Bandwidth :BWidth	
	:INtegration	<numeric_value>
	:FiLter	
	:COEfficient	<numeric_value>
	:TYpe	RECTangle GAUSSian NYQuist RNYQuist
	:LiMit	
	[:STATe]	<boolean>

[[:SENSe]:FLCDMA2K]:RLCDMA2K:CHPower:BANDwidth]:BWIDth :INTegration(?)

Sets or queries the channel bandwidth for the channel power measurement in the cdma2000 forward or reverse link analysis.

Syntax `[[:SENSe]:FLCDMA2K]:RLCDMA2K:CHPower:BANDwidth]:BWIDth :INTegration <value>`

`[[:SENSe]:FLCDMA2K]:RLCDMA2K:CHPower:BANDwidth]:BWIDth :INTegration?`

Arguments `<numeric_value>::=<NRf>` specifies the channel bandwidth for the channel power measurement. Range: Span/20 to full span [Hz].

Measurement Modes DEMFLCDMA2K, DEMRLCDMA2K

Examples `:SENSe:FLCDMA2K:CHPower:BANDwidth:INTegration 2.5MHz`
sets the channel bandwidth to 2.5 MHz for the channel power measurement in the cdma2000 forward link analysis.

[[:SENSe]:FLCDMA2K]:RLCDMA2K:CHPower:FILTer:COEFFicient(?)

Sets or queries the filter roll-off rate for the channel power measurement in the cdma2000 forward or reverse link analysis. This command is valid when NYQuist or RNYQuist is selected in the `[[:SENSe]:Standard:CHPower FILTer:TYPE` command.

Syntax `[[:SENSe]:FLCDMA2K]:RLCDMA2K:CHPower:FILTer:COEFFicient <value>`

`[[:SENSe]:FLCDMA2K]:RLCDMA2K:CHPower:FILTer:COEFFicient?`

Arguments `<value>::=<NRf>` specifies the roll-off rate. Range: 0.0001 to 1 (default: 0.5).

Measurement Modes DEMFLCDMA2K, DEMRLCDMA2K

Examples `:SENSe:FLCDMA2K:CHPower:FILTer:COEFFicient 0.1`
sets the filter roll-off rate to 0.1 for the channel power measurement in the cdma2000 forward link analysis.

[[:SENSE]:FLCDMA2K]:RLCDMA2K:CHPower:FILTer:TYPE(?)

Select or queries the filter for the channel power measurement in the cdma2000 forward or reverse link analysis.

Syntax [:SENSE]:FLCDMA2K|:RLCDMA2K:CHPower:FILTer:TYPE { RECTangle
 | GAUSSian | NYQuist | RNYQuist }

[:SENSE]:FLCDMA2K|:RLCDMA2K:CHPower:FILTer:TYPE?

Arguments RECTangle selects the rectangular filter.

 GAUSSian selects the Gaussian filter.

 NYQuist selects the Nyquist filter.

 RNYQuist selects the Root Nyquist filter.

Measurement Modes DEMFLCDMA2K, DEMRLCDMA2K

Examples :SENSE:FLCDMA2K:CHPower:FILTer:TYPE NYQuist
 selects the Nyquist filter for the channel power measurement in the cdma2000 forward link analysis.

[[:SENSe]:FLCDMA2K]:RLCDMA2K:CHPower:LIMit[:STATe](?)

Sets or queries whether to enable or disable the limit testing for the channel power measurement in the cdma2000 forward or reverse link analysis.

Syntax `[[:SENSe]:FLCDMA2K]:RLCDMA2K:CHPower:LIMit[:STATe] { ON | OFF
| 1 | 0 }`

`[[:SENSe]:FLCDMA2K]:RLCDMA2K:CHPower:LIMit[STATe]?`

Arguments ON or 1 enables the limit testing.

OFF or 0 disables the limit testing.

Measurement Modes DEMFLCDMA2K, DEMRLCDMA2K

Examples `:SENSe:FLCDMA2K:CHPower:LIMit:STATe ON`
enables the limit testing for the channel power measurement in the cdma2000 forward link analysis.

[[:SENSE]:FLCDMA2K]:RLCDMA2K:IM Subgroup**cdma2000, Option 25 Only**

The [[:SENSE]:Standard:IM] commands set up the conditions related to the intermodulation measurement in the cdma2000 forward or reverse link analysis.

NOTE. To use a command from this group, you must have selected DEMFLCDMA2K (cdma2000 forward link analysis) or DEMRLCDMA2K (cdma2000 reverse link analysis) using the :INSTRUMENT[:SELECT] command.

Command Tree	Header	Parameter
	[[:SENSE]	
	:FLCDMA2K :RLCDMA2K	
	:IM	
	:BANDwidth :BWIDTH	
	:INTEgration	<numeric_value>
	:FILTer	
	:COEFFicient	<numeric_value>
	:TYPE	RECTangle GAUSSian NYQuist RNYQuist
	:LIMit	
	:FORder	
	[:STATE]	<boolean>
	:TORder	
	[:STATE]	<boolean>
	:SCOFFset	<numeric_value>

[[:SENSe]:FLCDMA2K]:RLCDMA2K:IM:BANDwidth]:BWIDth:INTEgration(?)

Sets or queries the channel bandwidth for the intermodulation measurement in the cdma2000 forward or reverse link analysis.

Syntax `[[:SENSe]:FLCDMA2K]:RLCDMA2K:IM:BANDwidth]:BWIDth:INTEgration <value>`

`[[:SENSe]:FLCDMA2K]:RLCDMA2K:IM:BANDwidth]:BWIDth:INTEgration?`

Arguments `<value>::=<NRf>` specifies the bandwidth of the main channel for the intermodulation measurement. Range: Span/20 to full span [Hz].

Measurement Modes DEMFLCDMA2K, DEMRLCDMA2K

Examples `:SENSe:FLCDMA2K:IM:BANDwidth:INTEgration 2.5MHz`
sets the channel bandwidth to 2.5 MHz for the intermodulation measurement in the cdma2000 forward link analysis.

[[:SENSe]:FLCDMA2K]:RLCDMA2K:IM:FILTer:COEFFicient(?)

Sets or queries the filter roll-off rate for the intermodulation measurement in the cdma2000 forward or reverse link analysis. This command is valid when NYQuist or RNYQuist is selected in the `[[:SENSe]:FLCDMA2K]:RLCDMA2K:IM:FILTer:TYPE` command.

Syntax `[[:SENSe]:FLCDMA2K]:RLCDMA2K:IM:FILTer:COEFFicient <value>`

`[[:SENSe]:FLCDMA2K]:RLCDMA2K:IM:FILTer:COEFFicient?`

Arguments `<value>::=<NRf>` specifies the roll-off rate. Range: 0.0001 to 1 (default: 0.5).

Measurement Modes DEMFLCDMA2K, DEMRLCDMA2K

Examples `:SENSe:FLCDMA2K:IM:FILTer:COEFFicient 0.1`
sets the filter roll-off rate to 0.1 for the intermodulation measurement in the cdma2000 forward link analysis.

Related Commands `[[:SENSe]:FLCDMA2K]:RLCDMA2K:IM:FILTer:TYPE`

[[:SENSE]:FLCDMA2K]:RLCDMA2K:IM:FILTer:TYPE(?)

Select or queries the filter for the intermodulation measurement in the cdma2000 forward or reverse link analysis.

Syntax [:SENSE]:FLCDMA2K|:RLCDMA2K:IM:FILTer:TYPE { RECTangle | GAUSSian
 | NYQuist | RNYQuist }

[:SENSE]:FLCDMA2K|:RLCDMA2K:IM:FILTer:TYPE?

Arguments RECTangle selects the rectangular filter.

 GAUSSian selects the Gaussian filter.

 NYQuist selects the Nyquist filter.

 RNYQuist selects the Root Nyquist filter.

Measurement Modes DEMFLCDMA2K, DEMRLCDMA2K

Examples :SENSE:FLCDMA2K:IM:FILTer:TYPE NYQuist
 selects the Nyquist filter for the intermodulation measurement in the cdma2000
 forward link analysis.

[[:SENSe]:FLCDMA2K]:RLCDMA2K:IM:LIMit:FORDER[:STATe](?)

Sets or queries whether to enable or disable the fifth order limit testing for the intermodulation measurement in the cdma2000 forward or reverse link analysis.

Syntax `[[:SENSe]:FLCDMA2K]:RLCDMA2K:IM:LIMit:FORDER[:STATe] { ON | OFF
| 1 | 0 }`

`[[:SENSe]:FLCDMA2K]:RLCDMA2K:IM:LIMit:FORFer[:STATe]?`

Arguments ON or 1 enables the fifth order limit testing.

OFF or 0 disables the fifth order limit testing.

Measurement Modes DEMFLCDMA2K, DEMRLCDMA2K

Examples `:SENSe:FLCDMA2K:IM:LIMit:FORDER:STATe ON`
enables the fifth order limit testing for the intermodulation measurement in the cdma2000 forward link analysis.

[[:SENSe]:FLCDMA2K]:RLCDMA2K:IM:LIMit:TORDER[:STATe](?)

Sets or queries whether to enable or disable the third order limit testing for the intermodulation measurement in the cdma2000 forward or reverse link analysis.

Syntax `[[:SENSe]:FLCDMA2K]:RLCDMA2K:IM:LIMit:TORDER[:STATe] { ON | OFF
| 1 | 0 }`

`[[:SENSe]:FLCDMA2K]:RLCDMA2K:IM:LIMit:TORFer[:STATe]?`

Arguments ON or 1 enables the third order limit testing.

OFF or 0 disables the third order limit testing.

Measurement Modes DEMFLCDMA2K, DEMRLCDMA2K

Examples `:SENSe:FLCDMA2K:IM:LIMit:TORDER:STATe ON`
enables the third order limit testing for the intermodulation measurement in the cdma2000 forward link analysis.

[[:SENSE]:FLCDMA2K]:RLCDMA2K:IM:SCOFFset(?)

Sets or queries the second channel frequency for the intermodulation measurement in the cdma2000 forward or reverse link analysis.

Syntax [[:SENSE]:FLCDMA2K]:RLCDMA2K:IM:SCOFFset <value>

[[:SENSE]:FLCDMA2K]:RLCDMA2K:IM:SCOFFset?

Arguments <value>: :=<Nrf> specifies the second channel frequency for the intermodulation. Range: -span/2 to +span/2 [Hz].

Measurement Modes DEMFLCDMA2K, DEMRLCDMA2K

Examples :SENSE:FLCDMA2K:IM:SCOFFset 1.5MHz
sets the second channel frequency to 1.5 MHz for the intermodulation measurement in the cdma2000 forward link analysis.

[[:SENSe]:FLCDMA2K]:RLCDMA2K:MACCuracy Subgroup *cdma2000, Option 25 Only*

The [[:SENSe]:FLCDMA2K]:RLCDMA2K:MACCuracy commands set up the conditions related to the modulation accuracy measurement in the cdma2000 forward or reverse link analysis.

NOTE. To use a command from this group, you must have selected DEMFLCDMA2K (cdma2000 forward link analysis) or DEMRLCDMA2K (cdma2000 reverse link analysis) using the :INSTRument[:SElect] command.

Command Tree	Header	Parameter
	[[:SENSe]	
	:FLCDMA2K :RLCDMA2K	
	:MACCuracy	
	:ACCThreshold	<numeric_value>
	:FILTer	
	:MEASurement	OFF EQComp COMP
	:IQSWAap	<boolean>
	:LIMit	
	:EVM	
	:PEAK	
	[:STATe]	<boolean>
	:RMS	
	[:STATe]	<boolean>
	:PCDerror	
	[:STATe]	<boolean>
	:RHO	
	[:STATe]	<boolean>
	:TAU	
	[:STATe]	<boolean>
	:MLEVel	CHIP SYMBol
	:PNOFFset	<numeric_value>
	:QOF	<numeric_value>
	:RCONfig	<string>
	:SElect	
	:CODE	<numeric_value>
	:PCG	<numeric_value>
	:WCODe	COMPosite W2L W4L W8L W16L W32L W64L W128L

[[:SENSE]:FLCDMA2K]:RLCDMA2K:MACCuracy:ACCThreshold(?)

Sets or queries the active channel threshold level (in dB from the pilot), which is used for deciding whether a code channel is active or inactive, for the modulation accuracy measurement in the cdma2000 forward or reverse link analysis.

Syntax [[:SENSE]:FLCDMA2K]:RLCDMA2K:MACCuracy:ACCThreshold <value>
[[:SENSE]:FLCDMA2K]:RLCDMA2K:MACCuracy:ACCThreshold?

Arguments <numeric_value>::=<NRf> specifies the active channel threshold level.
Range: -50 to 50 dB.

Measurement Modes DEMFLCDMA2K, DEMRLCDMA2K

Examples :SENSE:FLCDMA2K:MACCuracy:ACCThreshold -100
sets the active channel threshold level to -100 dB for the modulation accuracy measurement in the cdma2000 forward link analysis.

[[:SENSE]:FLCDMA2K]:RLCDMA2K:MACCuracy:FILTer:MEASurement(?)

Selects or queries the measurement filter for the modulation accuracy measurement in the cdma2000 forward or reverse link analysis.

Syntax [[:SENSE]:FLCDMA2K]:RLCDMA2K:MACCuracy:FILTer:MEASurement { OFF
| EQComp | COMP }
[[:SENSE]:FLCDMA2K]:RLCDMA2K:MACCuracy:FILTer:MEASurement?

Arguments OFF specifies that no measurement filter is used.
EQComp selects the complementary filter and EQ (equalizer).
COMP selects the complementary filter.

Measurement Modes DEMFLCDMA2K, DEMRLCDMA2K

Examples :SENSE:FLCDMA2K:MACCuracy:FILTer:MEASurement COMP
selects the Complementary filter for the modulation accuracy measurement in the cdma2000 forward link analysis.

[[:SENSe]:FLCDMA2K]:RLCDMA2K:MACCuracy:IQSWap(?)

Sets or queries whether to enable or disable IQ swapping for the modulation accuracy measurement in the cdma2000 forward or reverse link analysis.

Syntax [:SENSe]:FLCDMA2K]:RLCDMA2K:MACCuracy:IQSWap { ON | OFF | 1 | 0 }
[:SENSe]:FLCDMA2K]:RLCDMA2K:MACCuracy:IQSWap?

Arguments ON or 1 enables the IQ swapping.
OFF or 0 disables the IQ swapping.

Measurement Modes DEMFLCDMA2K, DEMRLCDMA2K

Examples :SENSe:FLCDMA2K:MACCuracy:IQSWap ON
sets the IQ swapping to ON for the modulation accuracy measurement in the cdma2000 forward link analysis.

[[:SENSe]:FLCDMA2K]:RLCDMA2K:MACCuracy:LIMit:EVM:PEAK[:STATe](?)

Sets or queries whether to enable or disable the PEAK EVM limit checking for the modulation accuracy measurement in the cdma2000 forward or reverse link analysis.

Syntax [:SENSe]:FLCDMA2K]:RLCDMA2K:MACCuracy:LIMit:EVM:PEAK[:STATe]
{ ON | OFF | 1 | 0 }
[:SENSe]:FLCDMA2K]:RLCDMA2K:MACCuracy:LIMit:EVM:PEAK[:STATe]?

Arguments ON or 1 enables the peak EVM limit testing.
OFF or 0 disables the peak EVM limit testing.

Measurement Modes DEMFLCDMA2K, DEMRLCDMA2K

Examples :SENSe:FLCDMA2K:MACCuracy:LIMit:EVM:PEAK:STATe ON
enables the peak EVM limit testing for the modulation accuracy measurement in the cdma2000 forward link analysis.

[[:SENSE]:FLCDMA2K]:RLCDMA2K:MACCuracy:LIMit:EVM:RMS[:STATE](?)

Sets or queries whether to enable or disable the RMS EVM limit testing for the modulation accuracy measurement in the cdma2000 forward or reverse link analysis.

Syntax [:SENSE]:FLCDMA2K|:RLCDMA2K:MACCuracy:LIMit:EVM:RMS[:STATE]
 { ON | OFF | 1 | 0 }
 [:SENSE]:FLCDMA2K|:RLCDMA2K:MACCuracy:LIMit:EVM:RMS[:STATE]?

Arguments ON or 1 enables the RMS EVM limit testing.
 OFF or 0 disables the RMS EVM limit testing.

Measurement Modes DEMFLCDMA2K, DEMRLCDMA2K

Examples :SENSE:FLCDMA2K:MACCuracy:LIMit:EVM:RMS:STATE ON
 enables the RMS EVM limit testing for the modulation accuracy measurement in the cdma2000 forward link analysis.

[[:SENSE]:FLCDMA2K]:RLCDMA2K:MACCuracy:LIMit:PCDerror[:STATE](?)

Sets or queries whether to enable or disable the peak code domain error limit testing for the modulation accuracy measurement in the cdma2000 forward or reverse link analysis.

Syntax [:SENSE]:FLCDMA2K|:RLCDMA2K:MACCuracy:LIMit:PCDerror[:STATE]
 { ON | OFF | 1 | 0 }
 [:SENSE]:FLCDMA2K|:RLCDMA2K:MACCuracy:LIMit:PCDerror[:STATE]?

Arguments ON or 1 enables the peak code domain error limit testing.
 OFF or 0 disables the peak code domain error limit testing.

Measurement Modes DEMFLCDMA2K, DEMRLCDMA2K

Examples :SENSE:FLCDMA2K:MACCuracy:LIMit:PCDerror:STATE ON
 enables the peak code domain error limit testing for the modulation accuracy measurement in the cdma2000 forward link analysis.

[[:SENSe]:FLCDMA2K]:RLCDMA2K:MACCuracy:LIMit:RHO[:STATe](?)

Sets or queries whether to enable or disable the Rho limit testing for the modulation accuracy measurement in the cdma2000 forward or reverse link analysis.

Syntax [:SENSe]:FLCDMA2K[:RLCDMA2K:MACCuracy:LIMit:RHO[:STATe]
 { ON | OFF | 1 | 0 }

 [:SENSe]:FLCDMA2K[:RLCDMA2K:MACCuracy:LIMit:RHO[:STATe]?

Arguments ON or 1 enables the Rho limit testing.
 OFF or 0 disables the Rho limit testing.

Measurement Modes DEMFLCDMA2K, DEMRLCDMA2K

Examples :SENSe:FLCDMA2K:MACCuracy:LIMit:RHO:STATe ON
 enables the Rho limit testing for the modulation accuracy measurement in the
 cdma2000 forward link analysis.

[[:SENSe]:FLCDMA2K:MACCuracy:LIMit:TAU[:STATe](?)

Sets or queries whether to enable or disable the Tau limit testing for the modulation accuracy measurement in the cdma2000 forward link analysis.

Syntax [:SENSe]:FLCDMA2K:MACCuracy:LIMit:TAU[:STATe] { ON | OFF
 | 1 | 0 }

 [:SENSe]:FLCDMA2K:MACCuracy:LIMit:TAU[:STATe]?

Arguments ON or 1 enables the Tau limit testing.
 OFF or 0 disables the Tau limit testing.

Measurement Modes DEMFLCDMA2K

Examples :SENSe:FLCDMA2K:MACCuracy:LIMit:TAU:STATe ON
 enables the Tau limit testing for the modulation accuracy measurement in the
 cdma2000 forward link analysis.

[[:SENSE]:FLCDMA2K]:RLCDMA2K:MACCuracy:MLEVel(?)

Sets or queries the measurement level for the modulation accuracy measurement in the cdma2000 forward or reverse link analysis.

Syntax [:SENSE]:FLCDMA2K|:RLCDMA2K:MACCuracy:MLEVel { CHIP | SYMBol }
 [:SENSE]:FLCDMA2K|:RLCDMA2K:MACCuracy:MLEVel?

Arguments CHIP sets the measurement level to chip.
 SYMBol sets the measurement level symbol.

Measurement Modes DEMFLCDMA2K, DEMRLCDMA2K

Examples :SENSE:FLCDMA2K:MACCuracy:MLEVel CHIP
 sets the measurement level to CHIP for the modulation accuracy measurement in the cdma2000 forward link analysis.

[[:SENSE]:FLCDMA2K:MACCuracy:PNOffset(?)

Sets or queries the PN offset for the modulation accuracy measurement in the cdma2000 forward link analysis.

Syntax [:SENSE]:FLCDMA2K:MACCuracy:PNOffset <value>
 [:SENSE]:FLCDMA2K:MACCuracy:PNOffset?

Arguments <value>::=<NR1> specifies the PN offset. Range: 0 to 511.

Measurement Modes DEMFLCDMA2K

Examples :SENSE:FLCDMA2K:MACCuracy:PNOffset 100
 sets the PN offset to 100 for the modulation accuracy measurement in the cdma2000 forward link analysis.

[:SENSe]:FLCDMA2K:MACCuracy:QOF(?)

Sets or queries the Walsh code quasi-orthogonal function for the modulation accuracy measurement in the cdma2000 forward link analysis. This command is valid when :DISPlay:FLCDMA2K|:RLCDMA2K:DDEMod:MView:FORMat is MACCuracy and the [:SENSe]:FLCDMA2K|:RLCDMA2K:MACCuracy:MLEVel is SYMBol.

Syntax [:SENSe]:FLCDMA2K:MACCuracy:QOF <value>
 [:SENSe]:FLCDMA2K:MACCuracy:QOF?

Arguments <value>::=<NR1> specifies the Walsh code quasi-orthogonal function.
 Range: 0 to 3.

Measurement Modes DEMFLCDMA2K

Examples :SENSe:FLCDMA2K:MACCuracy:QOF 1
 sets the Walsh code quasi-orthogonal function to 1 for the modulation accuracy measurement in the cdma2000 forward link analysis.

Related Commands :DISPlay:FLCDMA2K|:RLCDMA2K:DDEMod:MView:FORMat,
 [:SENSe]:FLCDMA2K|:RLCDMA2K:MACCuracy:MLEVel

[[:SENSe]:FLCDMA2K]:RLCDMA2K:MACCuracy:RCONfig(?)

Selects or queries the available radio configuration for the modulation accuracy measurement in the cdma2000 forward or reverse link analysis.

Syntax [:SENSe]:FLCDMA2K|:RLCDMA2K:MACCuracy:RCONfig
 { "CDMAONE" | "CDMA2K1X" }

 [:SENSe]:FLCDMA2K|:RLCDMA2K:MACCuracy:RCONfig?

Arguments "CDMAONE" selects RC1/RC2 for FLCDMA2K and RLCDMA2K.

 "CDMA2K1X" selects RC3/RC4/RC5 for FLCDMA2K and RC3/RC4 for
 RLCDMA2K.

Measurement Modes DEMFLCDMA2K, DEMRLCDMA2K

Examples :SENSe:FLCDMA2K:MACCuracy:RCONfig "CDMAONE"
 sets the radio configuration to RC1/RC2 for the modulation accuracy measure-
 ment in the cdma2000 forward link analysis.

[[:SENSe]:FLCDMA2K]:RLCDMA2K:MACCuracy:SElect:CODE(?)

Sets or queries the code in the PCG for the modulation accuracy measurement in the cdma2000 forward or reverse link analysis. This command is only available when [[:SENSe]:FLCDMA2K]:RLCDMA2K:MACCuracy:MLEVel is SYMBol.

Syntax [[:SENSe]:FLCDMA2K]:RLCDMA2K:MACCuracy:SElect:CODE <value>
[[:SENSe]:FLCDMA2K]:RLCDMA2K:MACCuracy:SElect:CODE?

Arguments <value>::=<NR1> specifies the code in the PCG. The available ranges are shown in Table 2-109.

Table 2-111: Code range

Standard	RCONfig ¹	Range
FLCDMA2K	CDMAONE	64 fixed
	CDMA2K1X	4 to 128
RLCDMA2K	CDMA2K1X	2 to 64

¹ The [[:SENSe]:FLCDMA2K]:RLCDMA2K:MACCuracy:RCONfig command setting.

Measurement Modes DEMFLCDMA2K, DEMRLCDMA2K

Examples :SENSe:FLCDMA2K:MACCuracy:SElect:CODE 30
sets the code in the PCG to 30 for the modulation accuracy measurement in the cdma2000 forward link analysis.

Related Commands [[:SENSe]:FLCDMA2K]:RLCDMA2K:MACCuracy:MLEVel,
[[:SENSe]:FLCDMA2K]:RLCDMA2K:MACCuracy:RCONfig

[[:SENSe]:FLCDMA2K]:RLCDMA2K:MACCuracy:SElect:PCG(?)

Sets or queries the PCG for the modulation accuracy measurement in the cdma2000 forward or reverse link analysis.

Syntax [[:SENSe]:FLCDMA2K]:RLCDMA2K:MACCuracy:SElect:PCG <value>

[[:SENSe]:FLCDMA2K]:RLCDMA2K:MACCuracy:SElect:PCG?

Arguments <value>::=<NR1> specifies the PCG.
Range: -(number of analyzed half slots - 1) to 0.

Measurement Modes DEMFLCDMA2K, DEMRLCDMA2K

Examples :SENSe:FLCDMA2K:MACCuracy:SElect:PCG -10
sets the PCG to -10 for the modulation accuracy measurement in the cdma2000 forward link analysis.

[:SENSe]:FLCDMA2K[:RLCDMA2K:MACCuracy:WCODe(?)

Selects or queries the Walsh code length for the modulation accuracy measurement in the cdma2000 forward or reverse link analysis. This command is valid when [:SENSe]:FLCDMA2K[:RLCDMA2K:MACCuracy:RCONfig is CDMA2K1X.

Syntax [:SENSe]:FLCDMA2K[:RLCDMA2K:MACCuracy:WCODe { COMPOSITE | W2L | W4L | W8L | W16L | W32L | W64L | W128L }
[:SENSe]:FLCDMA2K[:RLCDMA2K:MACCuracy:WCODe?

Arguments Table 2-112 shows the Walsh code length selections.

Table 2-112: Walsh code length selections

Argument	Length
COMPOSITE	Composite
W2L ¹	2
W4L	4
W8L	8
W16L	16
W32L	32
W64L	64
W128L ²	128

¹ For the RLCDMA2K standard only.

² For the FLCDMA2K standard only.

Measurement Modes DEMFLCDMA2K, DEMRLCDMA2K

Examples :SENSe:FLCDMA2K:MACCuracy:WCODe W4L
sets the Walsh code length to 4 for the modulation accuracy measurement in the cdma2000 forward link analysis.

Related Commands [:SENSe]:FLCDMA2K[:RLCDMA2K:MACCuracy:RCONfig

[[:SENSE]:FLCDMA2K]:RLCDMA2K:OBWidth Subgroup**cdma2000, Option 25 Only**

The [[:SENSE]:FLCDMA2K]:RLCDMA2K:OBWidth commands set up the conditions related to the occupied bandwidth (OBW) measurement in the cdma2000 forward or reverse link analysis.

NOTE. To use a command from this group, you must have selected DEMFLCDMA2K (cdma2000 forward link analysis) or DEMRLCDMA2K (cdma2000 reverse link analysis) using the :INSTRument[:SELEct] command.

Command Tree	Header	Parameter
	[[:SENSE]	
	:FLCDMA2K :RLCDMA2K	
	:OBWidth	
	:LIMit	
	[:STATE]	<boolean>
	:PERCent	<numeric_value>

[[:SENSe]:FLCDMA2K]:RLCDMA2K:OBWidth:LIMit[:STATe](?)

Sets or queries whether to enable or disable the limit testing for the OBW measurement in the cdma2000 forward or reverse link analysis.

Syntax [:SENSe]:FLCDMA2K]:RLCDMA2K:OBWidth:LIMit[:STATe] { ON | OFF
 | 1 | 0 }
[:SENSe]:FLCDMA2K]:RLCDMA2K:OBWidth:LIMit[:STATe]?

Arguments ON or 1 enables the limit testing.
 OFF or 0 disables the limit testing.

Measurement Modes DEMFLCDMA2K, DEMRLCDMA2K

Examples :SENSe:FLCDMA2K:OBWidth:LIMit:STATe ON
 sets the limit testing to ON for the OBW measurement in the cdma2000 forward link analysis.

[[:SENSe]:FLCDMA2K]:RLCDMA2K:OBWidth:PERCent(?)

Sets or queries the occupied bandwidth for the OBW measurement in the cdma2000 forward or reverse link analysis.

Syntax [:SENSe]:FLCDMA2K]:RLCDMA2K:OBWidth:PERCent <value>
[:SENSe]:FLCDMA2K]:RLCDMA2K:OBWidth:PERCent?

Arguments <value>::=<NRf> specifies the occupied bandwidth.
 Range: 80% to 99.99% (default: 99%).

Measurement Modes DEMFLCDMA2K, DEMRLCDMA2K

Examples :SENSe:FLCDMA2K:OBWidth:PERCent 95PCT
 sets the occupied bandwidth to 95% for the OBW measurement in the cdma2000 forward link analysis.

[[:SENSE]:FLCDMA2K]:RLCDMA2K:PCCHannel Subgroup *cdma2000, Option 25 Only*

The [[:SENSE]:FLCDMA2K]:RLCDMA2K:PCCHannel commands set up the conditions related to the pilot to code channel measurement in the cdma2000 forward or reverse link analysis.

NOTE. To use a command from this group, you must have selected DEMFLCDMA2K (cdma2000 forward link analysis) or DEMRLCDMA2K (cdma2000 reverse link analysis) using the :INSTRument[:SElect] command.

Command Tree	Header	Parameter
	[[:SENSE]	
	:FLCDMA2K :RLCDMA2K	
	:PCCHannel	
	:ACCThreshold	<numeric_value>
	:FILTer	
	:MEASurement	OFF EQComp COMP
	:IQSWap	<boolean>
	:LIMit	
	:PHASe	
	[:STATe]	<boolean>
	:TIME	
	[:STATe]	<boolean>
	:PNOFFset	<numeric_value>
	:RCONfig	<string>
	:SElect	
	:CODE	<numeric_value>
	:PCG	<numeric_value>
	:WCODe	COMPOSITE W2L W4L W8L W16L W32L W64L W128L

[[:SENSe]:FLCDMA2K]:RLCDMA2K:PCCHannel:ACCThreshold(?)

Sets or queries the active channel threshold level (in dB from the pilot), which is used for deciding whether a code channel is active or inactive, for the pilot to code channel measurement in the cdma2000 forward or reverse link analysis.

Syntax [:SENSe]:FLCDMA2K|:RLCDMA2K:PCCHannel:ACCThreshold <value>
[:SENSe]:FLCDMA2K|:RLCDMA2K:PCCHannel:ACCThreshold?

Arguments <value>::=<NRf> specifies the active channel threshold level.
Range: -50 to 50 dB.

Measurement Modes DEMFLCDMA2K, DEMRLCDMA2K

Examples :SENSe:FLCDMA2K:PCCHannel:ACCThreshold -50dB
sets the active channel threshold level to -50 dB for the pilot to code channel measurement in the cdma2000 forward link analysis.

[[:SENSe]:FLCDMA2K]:RLCDMA2K:PCCHannel:FILTer:MEASurement(?)

Selects or queries the measurement filter for the pilot to code channel measurement in the cdma2000 forward or reverse link analysis.

Syntax [:SENSe]:FLCDMA2K|:RLCDMA2K:PCCHannel:FILTer:MEASurement { OFF
| EQComp | COMP }
[:SENSe]:FLCDMA2K|:RLCDMA2K:PCCHannel:FILTer:MEASurement?

Arguments OFF specifies that no measurement filter is used.
EQComp selects the complementary filter and EQ (equalizer).
COMP selects the complementary filter.

Measurement Modes DEMFLCDMA2K, DEMRLCDMA2K

Examples :SENSe:FLCDMA2K:PCCHannel:FILTer:MEASurement COMP
selects the complementary filter for the pilot to code channel measurement in the cdma2000 forward link analysis.

[[:SENSe]:FLCDMA2K]:RLCDMA2K:PCCHannel:IQSWap(?)

Sets or queries whether to enable or disable IQ swapping for the pilot to code channel measurement in the cdma2000 forward or reverse link analysis.

Syntax [:SENSe]:FLCDMA2K]:RLCDMA2K:PCCHannel:IQSWap { ON | OFF | 1 | 0 }
[:SENSe]:FLCDMA2K]:RLCDMA2K:PCCHannel:IQSWap?

Arguments ON or 1 enables the IQ swapping.
OFF or 0 disables the IQ swapping.

Measurement Modes DEMFLCDMA2K, DEMRLCDMA2K

Examples :SENSe:FLCDMA2K:PCCHannel:IQSWap ON
sets the IQ swapping to ON for the pilot to code channel measurement in the cdma2000 forward link analysis.

[[:SENSe]:FLCDMA2K]:RLCDMA2K:PCCHannel:LIMit:PHASe[:STATe](?)

Sets or queries whether to enable or disable the phase limit checking for the pilot to code channel measurement in the cdma2000 forward or reverse link analysis.

Syntax [:SENSe]:FLCDMA2K]:RLCDMA2K:PCCHannel:LIMit:PHASe[:STATe]
{ ON | OFF | 1 | 0 }
[:SENSe]:FLCDMA2K]:RLCDMA2K:PCCHannel:LIMit:PHASe[:STATe]?

Arguments ON or 1 enables the phase limit testing.
OFF or 0 disables the phase limit testing.

Measurement Modes DEMFLCDMA2K, DEMRLCDMA2K

Examples :SENSe:FLCDMA2K:PCCHannel:LIMit:PHASe:STATe ON
enables the phase limit testing for the pilot to code channel measurement in the cdma2000 forward link analysis.

[[:SENSe]:FLCDMA2K]:RLCDMA2K:PCCHannel:LIMit:TIME[:STATe](?)

Sets or queries whether to enable or disable the time limit testing for the pilot to code channel measurement in the cdma2000 forward or reverse link analysis.

Syntax [:SENSe]:FLCDMA2K]:RLCDMA2K:PCCHannel:LIMit:TIME[:STATe]
 { ON | OFF | 1 | 0 }

 [:SENSe]:FLCDMA2K]:RLCDMA2K:PCCHannel:LIMit:TIME[:STATe]?

Arguments ON or 1 enables the time limit testing.
 OFF or 0 disables the time limit testing.

Measurement Modes DEMFLCDMA2K, DEMRLCDMA2K

Examples :SENSe:FLCDMA2K:PCCHannel:LIMit:TIME:STATe ON
 enables the time limit testing for the pilot to code channel measurement in the
 cdma2000 forward link analysis.

[[:SENSe]:FLCDMA2K:PCCHannel:PNOFFset(?)

Sets or queries the PN offset for the pilot to code channel measurement in the cdma2000 forward link analysis.

Syntax [:SENSe]:FLCDMA2K:PCCHannel:PNOFFset <value>

 [:SENSe]:FLCDMA2K:PCCHannel:PNOFFset?

Arguments <numeric_value>::=<NR1> specifies the PN offset.
 Range: 0 to 511.

Measurement Modes DEMFLCDMA2K

Examples :SENSe:FLCDMA2K:PCCHannel:PNOFFset 100
 sets the PN offset to 100 for the pilot to code channel measurement in the
 cdma2000 forward link analysis.

[[:SENSE]:FLCDMA2K]:RLCDMA2K:PCCHannel:RCONfig(?)

Selects or queries the available radio configuration for the pilot to code channel measurement in the cdma2000 forward or reverse link analysis.

Syntax [:SENSE]:FLCDMA2K|:RLCDMA2K:PCCHannel:RCONfig
 { "CDMAONE" | "CDMA2K1X" }

 [:SENSE]:FLCDMA2K|:RLCDMA2K:PCCHannel:RCONfig?

Arguments "CDMAONE" selects RC1/RC2 for FLCDMA2K.

 "CDMA2K1X" selects RC3/RC4/RC5 for FLCDMA2K and RC3/RC4 for
 RLCDMA2K.

Measurement Modes DEMFLCDMA2K, DEMRLCDMA2K

Examples :SENSE:FLCDMA2K:PCCHannel:RCONfig "CDMAONE"
 sets the radio configuration to RC1/RC2 for the pilot to code channel measure-
 ment in the cdma2000 forward link analysis.

[[:SENSe]:FLCDMA2K]:RLCDMA2K:PCCHannel:SElect:CODE(?)

Sets or queries the code in the PCG for the pilot to code channel measurement in the cdma2000 forward or reverse link analysis.

Syntax [[:SENSe]:FLCDMA2K]:RLCDMA2K:PCCHannel:SElect:CODE <value>

[[:SENSe]:FLCDMA2K]:RLCDMA2K:PCCHannel:SElect:CODE?

Arguments <value>::=<NR1> specifies the code in the PCG. The available ranges are shown in Table 2-109.

Table 2-113: Code range

Standard	RCONfig ¹	Range
FLCDMA2K	CDMAONE	64 fixed
	CDMA2K1X	4 to 128
RLCDMA2K	CDMAONE	Not supported
	CDMA2K1X	2 to 64

¹ The [[:SENSe]:FLCDMA2K]:RLCDMA2K:PCCHannel:RCONfig command setting.

Measurement Modes DEMFLCDMA2K, DEMRLCDMA2K

Examples :SENSe:FLCDMA2K:PCCHannel:SElect:CODE 1
sets the code in the PCG to 1 for the pilot to code channel measurement in the cdma2000 forward link analysis.

Related Commands [[:SENSe]:FLCDMA2K]:RLCDMA2K:PCCHannel:RCONfig

[[:SENSE]:FLCDMA2K]:RLCDMA2K:PCCHannel:SElect:PCG(?)

Sets or queries the PCG (power control group) for the pilot to code channel measurement in the cdma2000 forward or reverse link analysis.

Syntax [:SENSE]:FLCDMA2K|:RLCDMA2K:PCCHannel:SElect:PCG <value>
[:SENSE]:FLCDMA2K|:RLCDMA2K:PCCHannel:SElect:PCG?

Arguments <value>::=<NR1> specifies the PCG.
Range: -(number of analyzed half slots - 1) to 0.

Measurement Modes DEMFLCDMA2K, DEMRLCDMA2K

Examples :SENSE:FLCDMA2K:PCCHannel:SElect:PCG -10
sets the PCG to -10 for the pilot to code channel measurement in the cdma2000 forward link analysis.

[[:SENSe]:FLCDMA2K]:RLCDMA2K:PCCHannel:WCODE(?)

Selects or queries the Walsh code length for the pilot to code channel measurement in the cdma2000 forward or reverse link analysis. This command is only available when [[:SENSe]:FLCDMA2K]:RLCDMA2K:PCCHannel:RCONfig is CDMA2K1X.

Syntax [[:SENSe]:FLCDMA2K]:RLCDMA2K:PCCHannel:WCODE { COMPOSITE | W2L | W4L | W8L | W16L | W32L | W64L | W128L }
[[:SENSe]:FLCDMA2K]:RLCDMA2K:PCCHannel:WCODE?

Arguments Table 2-110 shows the Walsh code length selections.

Table 2-114: Walsh code length selections

Argument	Length
COMPOSITE	Composite
W2L ¹	2
W4L	4
W8L	8
W16L	16
W32L	32
W64L	64
W128L ²	128

¹ For the RLCDMA2K standard only.

² For the FLCDMA2K standard only.

Measurement Modes DEMFLCDMA2K, DEMRLCDMA2K

Examples :SENSe:FLCDMA2K:PCCHannel:WCODE W4L
sets the Walsh code length to 4 for the pilot to code channel measurement in the cdma2000 forward link analysis.

Related Commands [[:SENSe]:FLCDMA2K]:RLCDMA2K:PCCHannel:RCONfig

[[:SENSE]:RLCDMA2K:PVTime Subgroup**cdma2000, Option 25 Only**

The [[:SENSE]:RLCDMA2K:PVTime commands set up the conditions related to the gated output power measurement in the cdma2000 forward link analysis. These commands are only available for the cdma2000 reverse link standard.

NOTE. To use a command from this group, you must have selected DEMFLCDMA2K (cdma2000 forward link analysis) or DEMRLCDMA2K (cdma2000 reverse link analysis) using the :INSTRument[:SElect] command.

Command Tree	Header	Parameter
	[[:SENSE]	
	:RLCDMA2K	
	:PVTime	
	:BURSt	
	:GATE	RPCHannel RFCHannel
	:OFFSet	<numeric_value>
	:SYNC	REDGe MPOint TPOsition
	:LiMit	
	:ZONE<x>	
	[:STATe]	<boolean>
	:RCHannel	
	:LEVel	<numeric_value>
	:MODE	AUTO MANUal

[:SENSe]:RLCDMA2K:PVTime:BURSt:GATE(?)

Sets or queries the burst gate for the gated output power measurement in the cdma2000 reverse link analysis.

Syntax [:SENSe]:RLCDMA2K:PVTime:BURSt:GATE { RPCHannel | RFCHannel }
[:SENSe]:RLCDMA2K:PVTime:BURSt:GATE?

Arguments RPCHannel sets the reverse pilot channel or RC1/RC2.
RFCHannel sets the reverse fundamental channel.

Measurement Modes DEMRLCDMA2K

Examples :SENSe:RLCDMA2K:PVTime:BURSt:GATE RFCHannel
sets the burst gate to the reverse fundamental channel for the gated output power measurement in the cdma2000 reverse link analysis.

[:SENSe]:RLCDMA2K:PVTime:BURSt:OFFSet(?)

Sets or queries the burst offset between the trigger position and burst position for the gated output power measurement in the cdma2000 reverse link analysis. This command is valid when the [:SENSe]:RLCDMA2K:PVTime:BURSt:SYNC command is set to TPOsition.

Syntax [:SENSe]:RLCDMA2K:PVTime:BURSt:OFFSet <value>
[:SENSe]:RLCDMA2K:PVTime:BURSt:OFFSet?

Arguments <numeric_value>::=<NRf> specifies the burst offset.
Range: -1 E-3 to 1 E-3 [s].

Measurement Modes DEMRLCDMA2K

Examples :SENSe:RLCDMA2K:PVTime:BURSt:OFFSet 100us
sets the burst offset to 100 ms for the gated output power measurement in the cdma2000 reverse link analysis.

Related Commands [:SENSe]:RLCDMA2K:PVTime:BURSt:SYNC

[[:SENSe]:RLCDMA2K:PVTime:BURSt:SYNC(?)]

Sets or queries the burst sync for the gated output power measurement in the cdma2000 reverse link analysis.

Syntax [:SENSe]:RLCDMA2K:PVTime:BYRSt:SYNC { REDGe | MP0int
 | TPOSition }

[:SENSe]:RLCDMA2K:PVTime:BURSt:SYNC?

Arguments REDGe specifies the rising edge for the burst sync.

 MP0int specifies the middle point for the burst sync.

 TPOSition specifies the trigger position for the burst sync.

Measurement Modes DEMRLCDMA2K

Examples :SENSe:RLCDMA2K:PVTime:BURSt:SYNC TPOSition
 sets the burst sync to the trigger position for the gated output power measurement in the cdma2000 reverse link analysis.

[[:SENSe]:RLCDMA2K:PVTime:LIMit:ZONE<x>[:STATe](?)

Sets or queries whether to enable or disable the zone limit testing for the gated output power measurement in the cdma2000 reverse link analysis.

Syntax [:SENSe]:RLCDMA2K:PVTime:LIMit:ZONE<x>[:STATe] { ON | OFF
 | 1 | 0 }

[:SENSe]:RLCDMA2K:PVTime:LIMit:ZONE<x>[:STATe]?

Where Zone<x> (x=1 to 5) correspond to Zone A, B, C, D, and E in the limit editor, respectively.

Arguments ON or 1 enables the zone limit testing.

OFF or 0 disables the zone limit testing.

Measurement Modes DEMRLCDMA2K

Examples :SENSe:RLCDMA2K:PVTime:LIMit:ZONE1 ON
 enables the limit testing of zone 1 for the gated output power measurement in the
 cdma2000 reverse link analysis.

[[:SENSe]:RLCDMA2K:PVTime:RCHannel:LEVel(?]

Sets or queries the reference channel level to measure the power level in dB. This command is only available when the [:SENSe]:RLCDMA2K:PVTime:RCHannel:MODE command is set to MANual.

Syntax [:SENSe]:RLCDMA2K:PVTime:RCHannel:LEVel <value>
[:SENSe]:RLCDMA2K:PVTime:RCHannel:LEVel?

Arguments <value>::=<NRf> specifies the reference channel level.
Range: -150 to 30 dBm.

Measurement Modes DEMRLCDMA2K

Examples :SENSe:RLCDMA2K:PVTime:RCHannel:LEVel -10dBm
sets the reference channel level to -10 dBm for the gated output power measurement in the cdma2000 reverse link analysis.

Related Commands [:SENSe]:RLCDMA2K:PVTime:RCHannel:MODE

[[:SENSe]:RLCDMA2K:PVTime:RCHannel:MODE(?)]

Sets or queries the mode of the reference channel level to measure the power level in dB.

Syntax [:SENSe]:RLCDMA2K:PVTime:RCHannel:MODE { AUTO | MANua1 }

[:SENSe]:RLCDMA2K:PVTime:RCHannel:MODE?

Arguments AUTO specifies that the reference level is measured from the input signal.

MANua1 specifies that the reference level is set manually. Use the [:SENSe]:RLCDMA2K:PVTime:RCHannel:LEVel command.

Measurement Modes DEMRLCDMA2K

Examples :SENSe:RLCDMA2K:PVTime:RCHannel:MODE AUTO
sets the mode of the reference channel level to AUTO for the gated output power measurement in the cdma2000 reverse link analysis.

Related Commands [:SENSe]:RLCDMA2K:PVTime:RCHannel:LEVel

[[:SENSE]:FLCDMA2K]:RLCDMA2K:SEMask Subgroup*cdma2000, Option 25 Only*

The [[:SENSE]:FLCDMA2K]:RLCDMA2K:SEMask commands set up the conditions related to the spectrum emission mask measurement in the cdma2000 forward or reverse link analysis.

NOTE. To use a command from this group, you must have selected DEMFLCDMA2K (cdma2000 forward link analysis) or DEMRLCDMA2K (cdma2000 reverse link analysis) using the :INSTRUMENT[:SElect] command.

Command Tree	Header	Parameter
	[[:SENSE]	
	:FLCDMA2K :RLCDMA2K	
	:SEMask	
	:BANDwidth :BWIDTH	
	:INTegration	<numeric_value>
	:FILTer	
	:COEfficient	<numeric_value>
	:TYPE	RECTangle GAUSSian NYQuist RNYQuist
	:LIMit	
	:ISPurious	
	:ZONE<x>	
	[[:STATE]	<boolean>
	:OFCHannel	
	:ZONE<x>	
	[[:STATE]	<boolean>
	:MEASurement	OFCHannel ISPurious
	:RCHannel	
	:LEVel	<numeric_value>
	:MODE	AUTO MANual

[[:SENSe]:FLCDMA2K]:RLCDMA2K:SEMask:BANDwidth]:BWIDth:INTegration(?)

Sets or queries the channel bandwidth for the spectrum emission mask measurement in the cdma2000 forward or reverse link analysis.

Syntax `[[:SENSe]:FLCDMA2K]:RLCDMA2K:SEMask:BANDwidth]:BWIDth:INTegration <value>`

`[[:SENSe]:FLCDMA2K]:RLCDMA2K:SEMask:BANDwidth]:BWIDth:INTegration?`

Arguments `<value>::=<NRf>` specifies the channel bandwidth.
Range: Span/20 to full span [Hz].

Measurement Modes DEMFLCDMA2K, DEMRLCDMA2K

Examples `:SENSe:FLCDMA2K:SEMask:BANDwidth:INTegration 2.5MHz`
sets the channel bandwidth to 2.5 MHz for the spectrum emission mask measurement in the cdma2000 forward link analysis.

[[:SENSe]:FLCDMA2K]:RLCDMA2K:SEMask:FILTer:COEFFicient(?)

Sets or queries the filter roll-off rate for the spectrum emission mask measurement in the cdma2000 forward or reverse link analysis. This command is only available when the `[[:SENSe]:FLCDMA2K]:RLCDMA2K:SEMask:FILTer:TYPE` command is set to NYQuist or RNYQuist.

Syntax `[[:SENSe]:FLCDMA2K]:RLCDMA2K:SEMask:FILTer:COEFFicient <value>`

`[[:SENSe]:FLCDMA2K]:RLCDMA2K:SEMask:FILTer:COEFFicient?`

Arguments `<value>::=<NRf>` specifies the roll-off rate.
Range: 0.0001 to 1 (default: 0.5).

Measurement Modes DEMFLCDMA2K, DEMRLCDMA2K

Examples `:SENSe:FLCDMA2K:SEMask:FILTer:COEFFicient 0.1`
sets the filter roll-off rate to 0.1 for the spectrum emission mask measurement in the cdma2000 forward link analysis.

Related Commands [:SENSe]:FLCDMA2K[:RLCDMA2K]:SEMAsk:FILTer:TYPE

[:SENSe]:FLCDMA2K[:RLCDMA2K]:SEMAsk:FILTer:TYPE(?)

Selects or queries the filter for the spectrum emission mask measurement in the cdma2000 forward or reverse link analysis.

Syntax [:SENSe]:FLCDMA2K[:RLCDMA2K]:SEMAsk:FILTer:TYPE { RECTangle
| GAUSsian | NYQuist | RNYQuist }

[:SENSe]:FLCDMA2K[:RLCDMA2K]:SEMAsk:FILTer:TYPE?

Arguments RECTangle selects the rectangular filter.
GAUSsian selects the Gaussian filter.
NYQuist selects the Nyquist filter.
RNYQuist selects the Root Nyquist filter.

Measurement Modes DEMFLCDMA2K, DEMRLCDMA2K

Examples :SENSe:FLCDMA2K:SEMAsk:FILTer:TYPE NYQuist
selects the Nyquist filter for the spectrum emission measurement in the cdma2000 forward link analysis.

[[:SENSe]:FLCDMA2K]:RLCDMA2K:SEMask:LIMit:ISpurious:ZONE<x> [:STATE] (?)

Sets or queries whether to enable or disable the inband spurious zone limit testing for the spectrum emission mask measurement in the cdma2000 forward or reverse link analysis.

Syntax [:SENSe]:FLCDMA2K]:RLCDMA2K:SEMask:LIMit:ISpurious:ZONE<x>
[:STATE] { ON | OFF | 1 | 0 }

[:SENSe]:FLCDMA2K]:RLCDMA2K:SEMask:LIMit:ISpurious:ZONE<x>
[:STATE]?

Where Zone<x> (x=1 to 5) correspond to Zone A, B, C, D, and E in the limit editor, respectively.

Arguments ON or 1 enables the inband spurious zone limit testing.
OFF or 0 disables the inband spurious zone limit testing.

Measurement Modes DEMFLCDMA2K, DEMRLCDMA2K

Examples :SENSe:FLCDMA2K:SEMask:LIMit:ISpurious:ZONE1:STATE ON
enables the inband spurious limit testing of zone 1 for the spectrum emission mask measurement in the cdma2000 forward link analysis.

[[:SENSE]:FLCDMA2K]:RLCDMA2K:SEMask:LIMit:OFCHannel:ZONE<x> [:STATE](?)

Sets or queries whether to enable or disable the offset from the channel zone limit testing for the spectrum emission mask measurement in the cdma2000 forward or reverse link analysis.

Syntax [:SENSE]:FLCDMA2K|:RLCDMA2K:SEMask:LIMit:OFCHannel:ZONE<x>
[:STATE] { ON | OFF | 1 | 0 }

[:SENSE]:FLCDMA2K|:RLCDMA2K:SEMask:LIMit:OFCHannel:ZONE<x>
[:STATE]?

Where Zone<x> (x=1 to 5) correspond to Zone A, B, C, D, and E in the limit editor, respectively.

Arguments ON or 1 enables the offset from the channel zone limit testing.
OFF or 0 disables the offset from the channel zone limit testing.

Measurement Modes DEMFLCDMA2K, DEMRLCDMA2K

Examples :SENSE:FLCDMA2K:SEMask:LIMit:OFCHannel:ZONE1:STATE ON
enables the offset from the channel limit testing of zone 1 for the spectrum emission mask measurement in the cdma2000 forward link analysis.

[[:SENSe]:FLCDMA2K]:RLCDMA2K:SEMask:MEASurement(?)

Sets or queries the limit table type used for limit testing for the spectrum emission mask measurement in the cdma2000 forward or reverse link analysis.

Syntax [:SENSe]:FLCDMA2K]:RLCDMA2K:SEMask:MEASurement
 { OFCHannel | ISpurious }

 [:SENSe]:FLCDMA2K]:RLCDMA2K:SEMask:MEASurement?

Arguments OFCHannel selects the Offset From Channel type where frequency zones are specified by the difference from the center frequency.

ISpurious selects the Inband Spurious type in which frequency zones are specified by the absolute values.

Measurement Modes DEMFLCDMA2K, DEMRLCDMA2K

Examples :SENSe:FLCDMA2K:SEMask:MEASurement ISpurious
 selects the Inband Spurious limit table for the spectrum emission mask measurement in the cdma2000 forward link analysis.

[[:SENSe]:FLCDMA2K]:RLCDMA2K:SEMask:RCHannel:LEVel(?)

Sets or queries the reference channel level to measure the spurious emission level in dBc. This command is valid when [:SENSe]:FLCDMA2K]:RLCDMA2K:SEMask:RCHannel:MODE is MANual.

Syntax [:SENSe]:FLCDMA2K]:RLCDMA2K:SEMask:RCHannel:LEVel <value>
 [:SENSe]:FLCDMA2K]:RLCDMA2K:SEMask:RCHannel:LEVel?

Arguments <value>::=<NRf> specifies the reference level. Range: -150 to 30 dBm.

Measurement Modes DEMFLCDMA2K, DEMRLCDMA2K

Examples :SENSe:FLCDMA2K:SEMask:RCHannel:LEVel -10dBm
 sets the reference channel level to -10 dBm for the spectrum emission mask measurement in the cdma2000 forward link analysis.

Related Commands [:SENSe]:FLCDMA2K]:RLCDMA2K:SEMask:RCHannel:MODE

[[:SENSE]:FLCDMA2K]:RLCDMA2K:SEMask:RCHannel:MODE(?)

Sets or queries the mode of the reference channel level to measure the spurious emission level in dBc.

Syntax [:SENSE]:FLCDMA2K|:RLCDMA2K:SEMask:RCHannel:MODE
 { AUTO | MANua1 }
 [:SENSe]:FLCDMA2K|:RLCDMA2K:SEMask:RCHannel:MODE?

Arguments AUTO specifies that the reference level is measured from the input signal.
 MANua1 allows you to set the reference level using the
 [:SENSe]:FLCDMA2K|:RLCDMA2K:SEMask:RCHannel:LEVel command.

Measurement Modes DEMFLCDMA2K, DEMRLCDMA2K

Examples :SENSe:FLCDMA2K:SEMask:RCHannel:MODE AUTO
 sets the mode of the reference channel level to AUTO for the spectrum emission
 mask measurement in the cdma2000 forward link analysis.

Related Commands [:SENSe]:FLCDMA2K|:RLCDMA2K:SEMask:RCHannel:LEVel

[[:SENSe]:FL1XEVD0]:RL1XEVD0 Subgroup**1xEV-DO, Option 26 Only**

The [[:SENSe]:FL1XEVD0]:RL1XEVD0 commands set up the conditions related to the 1xEV-DO forward link or reverse link analysis.

NOTE. To use a command from this group, you must have selected *DEMFL1XEVD0* (1xEV-DO forward link analysis) or *DEMRL1XEVD0* (1xEV-DO reverse link analysis) using the *:INSTRument[:SElect]* command.

Command Tree	Header	Parameter
	[[:SENSe]	
	:FL1XEVD0]:RL1XEVD0	
	:ACQuisition	
	:CHIPs	<numeric_value>
	:HISTory	<numeric_value>
	:SEConds	<numeric_value>
	:ANALysis	
	:INTerval	<numeric_value>
	:OFFSet	<numeric_value>
	:BLOCK	<numeric_value>
	[:IMMediate]	
	:MEASurement	CHPower ACPower IM SEMask CDPower MACCuracy CCDF PVTTime PCCHannel OBWidth OFF
	:SPECTrum	
	:OFFSet	<numeric_value>
	:TINTerval	

[[:SENSE]:FL1XEVD0|:RL1XEVD0:ACQuisition:CHIPs(?]

Sets or queries the acquisition length in chips.

Syntax [:SENSE]:FL1XEVD0|:RL1XEVD0:ACQuisition:CHIPs <value>
 [:SENSE]:FL1XEVD0|:RL1XEVD0:ACQuisition:CHIPs?

Arguments <value>::=<NR1> specifies the acquisition length in chips. The setting range depends on span and memory length. The minimum value is 6144.

Measurement Modes DEMFL1XEVD0, DEMRL1XEVD0

Examples :SENSE:FL1XEVD0:ACQuisition:CHIPs 10240
 sets the acquisition length in chips to 10240 in the 1xEV-DO forward link analysis.

[[:SENSE]:FL1XEVD0|:RL1XEVD0:ACQuisition:HISTory(?]

Sets or queries the acquisition history. The acquisition can be viewed as it is selected, and can be reanalyzed after the selection.

Syntax [:SENSE]:FL1XEVD0|:RL1XEVD0:ACQuisition:HISTory <value>
 [:SENSE]:FL1XEVD0|:RL1XEVD0:ACQuisition:HISTory?

Arguments <value>::=<NR1> specifies the acquisition history. Zero represents the latest. The setting range depends on span and memory length.

Measurement Modes DEMFL1XEVD0, DEMRL1XEVD0

Examples :SENSE:FL1XEVD0:ACQuisition:HISTory 0
 sets the acquisition history to 0 in the 1xEV-DO forward link analysis.

[[:SENSe]:FL1XEVD0]:RL1XEVD0:ACQuisition:SEConds(?)

Sets or queries the acquisition length in seconds.

Syntax [:SENSe]:FL1XEVD0]:RL1XEVD0:ACQuisition:SEConds <value>
 [:SENSe]:FL1XEVD0]:RL1XEVD0:ACQuisition:SEConds?

Arguments <value>::=<NRf> specifies the acquisition length in seconds.
 Range: 4.998 ms to no logical limitation (depends on span and memory length).

Measurement Modes DEMFL1XEVD0, DEMRL1XEVD0

Examples :SENSe:FL1XEVD0:ACQuisition:SEConds 9.163ms
 sets the acquisition length to 9.163 ms in the 1xEV-DO forward link analysis.

[[:SENSe]:FL1XEVD0|:RL1XEVD0:ANALysis:INTerval(?]

Sets or queries the analysis interval in chips.

Syntax [:SENSe]:FL1XEVD0|:RL1XEVD0:ANALysis:INTerval <value>
 [:SENSe]:FL1XEVD0|:RL1XEVD0:ANALysis:INTerval?

Arguments <value>::=<NR1> specifies the analysis interval in half slots.
 The range depends on the acquisition length setting.

Measurement Modes DEMFL1XEVD0, DEMRL1XEVD0

Examples :SENSe:FL1XEVD0:ANALysis:INTerval 10
 sets the analysis interval in half slots to 10 in the 1xEV-DO forward link analysis.

[[:SENSe]:FL1XEVD0|:RL1XEVD0:ANALysis:OFFSet(?]

Sets or queries the analysis offset (the start point of the analysis range) in half slots.

Syntax [:SENSe]:FL1XEVD0|:RL1XEVD0:ANALysis:OFFSet <value>
 [:SENSe]:FL1XEVD0|:RL1XEVD0:ANALysis:OFFSet?

Arguments <value>::=<NR1> specifies the analysis offset in half slots.
 Range: 0 to 12293 half slot

Measurement Modes DEMFL1XEVD0, DEMRL1XEVD0

Examples :SENSe:FL1XEVD0:ANALysis:OFFSet 10
 sets the analysis offset in half slots to 10 in the 1xEV-DO forward link analysis.

[[:SENSe]:FL1XEVD0]:RL1XEVD0:BLOCK(?)

Sets or queries the number of the block to measure in the 1xEV-DO forward or reverse link analysis.

Syntax [:SENSe]:FL1XEVD0|:RL1XEVD0:BLOCK <value>
 [:SENSe]:FL1XEVD0|:RL1XEVD0:BLOCK?

Arguments <value>::=<NR1> specifies the block number. Zero represents the latest block.
Range: -M to 0 (M: number of acquired blocks).

Measurement Modes DEMFL1XEVD0, DEMRL1XEVD0

Examples :SENSe:FL1XEVD0:BLOCK -5
 sets the block number to -5 in the 1xEV-DO forward link analysis.

[[:SENSe]:FL1XEVD0]:RL1XEVD0[:IMMediate] (No Query Form)

Performs calculation for the acquired data in the 1xEV-DO forward or reverse link analysis.

Syntax [:SENSe]:FL1XEVD0|:RL1XEVD0[:IMMediate]

Arguments None

Measurement Modes DEMFL1XEVD0, DEMRL1XEVD0

Examples :SENSe:FL1XEVD0:IMMediate
 performs calculation for the acquired data in the 1xEV-DO forward link analysis.

[[:SENSe]:FL1XEVD0]:RL1XEVD0:MEASurement(?)

Selects or queries the measurement item for the 1xEV-DO forward or reverse link analysis.

Syntax [[:SENSe]:FL1XEVD0]:RL1XEVD0:MEASurement { CHPower | ACPower | IM
| SEMask | CDPower | MACCuracy | CCDF | PVTime | PCCHannel
| OBWidth | OFF }

[[:SENSe]:FL1XEVD0]:RL1XEVD0:MEASurement?

Arguments Table 2-108 shows the measurement item selections in the 1xEV-DO analysis.

Table 2-115: Measurement item selections

Argument	Measurement item
CHPower	Channel power measurement
ACPower	ACPR measurement
IM	Intermodulation measurement
SEMask	Spectrum emission mask measurement
CDPower	Code domain power measurement
MACCuracy	Modulation accuracy measurement
CCDF	CCDF measurement
PVTime ¹	Gated output power measurement
PCCHannel	Pilot to code channel measurement
OBWidth	Occupied bandwidth measurement
OFF	Measurement OFF

¹ Available in the RL1XEVD0 mode only.

Measurement Modes DEMFL1XEVD0, DEMRL1XEVD0

Examples :SENSe:FL1XEVD0:MEASurement CCDF
selects the CCDF measurement for the 1xEV-DO forward link analysis.

[[:SENSe]:FL1XEVD0]:RL1XEVD0:SPECtrum:OFFSet(?)

Sets or queries the spectrum offset within the time window in the 1xEV-DO forward or reverse link analysis.

Syntax [[:SENSe]:FL1XEVD0]:RL1XEVD0:SPECtrum:OFFSet <value>

[[:SENSe]:FL1XEVD0]:RL1XEVD0:SPECtrum:OFFSet?

Arguments <value>: :=<NRf> specifies the spectrum offset within the time windows.
Range: 0 ms to 26.56 ms.

Measurement Modes DEMFL1XEVD0, DEMRL1XEVD0

Examples :SENSe:FL1XEVD0:SPECtrum:OFFSet 10ms
sets the spectrum offset within the time window to 10 ms in the 1xEV-DO forward link analysis.

[[:SENSe]:FL1XEVD0]:RL1XEVD0:SPECtrum:TINTerval? (Query Only)

Queries the length of the time-domain information used to construct the spectrum trace in the 1xEV-DO forward link or reverse link analysis.

Syntax [[:SENSe]:FL1XEVD0]:RL1XEVD0:SPECtrum:TINTerval?

Arguments None

Measurement Modes DEMFL1XEVD0, DEMRL1XEVD0

Examples :SENSe:FL1XEVD0:SPECtrum:TINTerval?
returns the length of the time-domain information in the 1xEV-DO forward link analysis.

[[:SENSE]:FL1XEVD0]:RL1XEVD0:ACPower Subgroup**1xEV-DO, Option 26 Only**

The [[:SENSE]:FL1XEVD0]:RL1XEVD0:ACPower commands set up the conditions related to the ACPR measurement in the 1xEV-DO forward or reverse link analysis.

NOTE. To use a command from this group, you must have selected *DEMFL1XEVD0* (1xEV-DO forward link analysis) or *DEMRL1XEVD0* (1xEV-DO reverse link analysis) using the *:INSTRUMENT[:SELECT]* command.

Command Tree	Header	Parameter
	[[:SENSE]	
	:FL1XEVD0]:RL1XEVD0	
	:ACPower	
	:BANDwidth]:BWIDTH	
	:INTegration	<numeric_value>
	:FILTer	
	:COEfficient	<numeric_value>
	:TYPE	RECTangle GAUSSian NYQuist RNYQuist
	:LIMit	
	:ADJacent<x>	
	[:STATE]	<boolean>

[[:SENSe]:FL1XEVD0]:RL1XEVD0:ACPower:BANDwidth]:BWIDth:INTEgration(?)

Sets or queries the bandwidth of the main channel for the ACPR measurement in the 1xEV-DO forward or reverse link analysis.

Syntax `[[:SENSe]:FL1XEVD0]:RL1XEVD0:ACPower:BANDwidth]:BWIDth:INTEgration <value>`

`[[:SENSe]:FL1XEVD0]:RL1XEVD0:ACPower:BANDwidth]:BWIDth:INTEgration?`

Arguments `<value>::=<NRf>` specifies the bandwidth of the main channel for the ACPR measurement. Range: Span/20 to full span [Hz].

Measurement Modes DEMFL1XEVD0, DEMRL1XEVD0

Examples `:SENSe:FL1XEVD0:ACPower:BANDwidth:INTEgration 2.5MHz`
sets the bandwidth of the main channel to 2.5 MHz in the 1xEV-DO forward link analysis.

[[:SENSe]:FL1XEVD0]:RL1XEVD0:ACPower:FILTer:COEFFicient(?)

Sets or queries the filter roll-off rate for the ACPR measurement in the 1xEV-DO forward or reverse link analysis.

Syntax `[[:SENSe]:FL1XEVD0]:RL1XEVD0:ACPower:FILTer:COEFFicient <value>`

`[[:SENSe]:FL1XEVD0]:RL1XEVD0:ACPower:FILTer:COEFFicient?`

Arguments `<value>::=<NRf>` specifies the roll-off rate. Range: 0 to 1.

Measurement Modes DEMFL1XEVD0, DEMRL1XEVD0

Examples `:SENSe:FL1XEVD0:ACPower:FILTer:COEFFicient 0.5`
sets the filter roll-off rate for the ACPR measurement to 0.5 in the 1xEV-DO forward link analysis.

[[:SENSE]:FL1XEVD0|:RL1XEVD0:ACPower:FILTer:TYPE(?)]

Select or queries the filter for the ACPR measurement in the 1xEV-DO forward or reverse link analysis.

Syntax [:SENSE]:FL1XEVD0|:RL1XEVD0:ACPower:FILTer:TYPE { RECTangle
 | GAUSSian | NYQuist | RNYQuist }

[:SENSE]:FL1XEVD0|:RL1XEVD0:ACPower:FILTer:TYPE?

Arguments RECTangle selects the rectangular filter.

 GAUSSian selects the Gaussian filter.

 NYQuist selects the Nyquist filter.

 RNYQuist selects the Root Nyquist filter.

Measurement Modes DEMFL1XEVD0, DEMRL1XEVD0

Examples :SENSE:FL1XEVD0:ACPower:FILTer:TYPE NYQuist
 selects the Nyquist filter for the ACPR measurement in the 1xEV-DO forward
 link analysis.

[[:SENSe]:FL1XEVD0]:RL1XEVD0:ACPower:LIMit:ADJacent<x>[:STATe](?)

Sets or queries whether to enable or disable the adjacent limit testing for the ACPR measurement in the 1xEV-DO forward or reverse link analysis.

Syntax [:SENSe]:FL1XEVD0|:RL1XEVD0:ACPower:LIMit:ADJacent<x>[:STATe]
 { ON | OFF | 1 | 0 }

[:SENSe]:FL1XEVD0|RL1XEVD0:ACPower:LIMit:ADJacent<x>[:STATe]?

Where

ADJacent<x> (x=1 to 12) represents the xth adjacent.

Arguments ON or 1 enables the adjacent limit testing.

OFF or 0 disables the adjacent limit testing.

Measurement Modes DEMFL1XEVD0, DEMRL1XEVD0

Examples :SENSe:FL1XEVD0:ACPower:LIMit:ADJacent1 ON
enables the first adjacent limit testing for the ACPR measurement in the 1xEV-DO forward link analysis.

[[:SENSE]:FL1XEVD0|:RL1XEVD0]:CCDF Subgroup**1xEV-DO, Option 26 Only**

The [[:SENSE]:FL1XEVD0|:RL1XEVD0]:CCDF commands set up the conditions related to the CCDF measurement in the 1xEV-DO forward or reverse link analysis.

NOTE. To use a command from this group, you must have selected *DEMFL1XEVD0* (1xEV-DO forward link analysis) or *DEMRL1XEVD0* (1xEV-DO reverse link analysis) using the *:INSTRUMENT[:SELEct]* command.

Command Tree	Header	Parameter
	[[:SENSE]	
	:FL1XEVD0 :RL1XEVD0	
	:CCDF	
	:RMEasurement	
	:THReshold	<numeric_value>

[[:SENSe]:FL1XEVD0]:RL1XEVD0:CCDF:RMEasurement (No Query Form)

Clears the CCDF accumulator and restarts the measurement.

Syntax [:SENSe]:FL1XEVD0]:RL1XEVD0:CCDF:RMEasurement

Arguments None

Measurement Modes DEMFL1XEVD0, DEMRL1XEVD0

Examples :SENSe:FL1XEVD0:CCDF:RMEasurement
clears the CCDF accumulator and restarts the CCDF measurement in the
1xEV-DO forward link analysis.

[[:SENSe]:FL1XEVD0]:RL1XEVD0:CCDF:THReshold(?)

Sets or queries the threshold for the CCDF measurement in the 1xEV-DO forward or reverse link analysis.

Syntax [:SENSe]:FL1XEVD0]:RL1XEVD0:CCDF:THReshold <value>
[:SENSe]:FL1XEVD0]:RL1XEVD0:CCDF:THReshold?

Arguments <value>: :=<NRf> specifies the threshold for the CCDF measurement.
Range: -250 to 130 dBm.

Measurement Modes DEMFL1XEVD0, DEMRL1XEVD0

Examples :SENSe:FL1XEVD0:CCDF:THReshold -100dBm
sets the threshold for the CCDF measurement to -100 dBm in the 1xEV-DO
forward link analysis.

[[:SENSE]:FL1XEVD0|:RL1XEVD0]:CDPower Subgroup

1xEV-DO, Option 26 Only

The [[:SENSE]:FL1XEVD0|:RL1XEVD0]:CDPower commands set up the conditions related to the code domain power measurement in the 1xEV-DO forward or reverse link analysis.

NOTE. To use a command from this group, you must have selected DEMFL1XEVD0 (1xEV-DO forward link analysis) or DEMRL1XEVD0 (1xEV-DO reverse link analysis) using the :INSTRUMENT[:SELEct] command.

Command Tree	Header	Parameter
	[[:SENSE]	
	:FL1XEVD0 :RL1XEVD0	
	:CDPower	
	:ACCThreshold	<numeric_value>
	:CHANnel	
	[:TYPE]	MAC PILOT DATA PREAMBLE OVERALL
	:FILTer	
	:MEASurement	OFF EQComp COMP
	:IQSWap	<boolean>
	:LCMask	
	:I	<num1>,<num2>,<num3>
	:Q	<num1>,<num2>,<num3>
	:MLEVel	CHIP SYMBOL
	:PNOFFset	<numeric_value>
	:SELEct	
	:CODE	<numeric_value>
	:HSLot	<numeric_value>

[[:SENSe]:FL1XEVD0]:RL1XEVD0:CDPower:ACCThreshold(?)

Sets or queries the active channel threshold level (in dB from the pilot), which is used for deciding whether a code channel is active or inactive, for the code domain power measurement in the 1xEV-DO forward or reverse link analysis.

Syntax [:SENSe]:FL1XEVD0|:RL1XEVD0:CDPower:ACCThreshold <value>
[:SENSe]:FL1XEVD0|:RL1XEVD0:CDPower:ACCThreshold?

Arguments <value>::=<NRf> specifies the active channel threshold level.
Range: -100 to 0 dB

Measurement Modes DEMFL1XEVD0, DEMRL1XEVD0

Examples :SENSe:FL1XEVD0:CDPower:ACCThreshold -27dB
sets the active channel threshold level to -27 dB for the code domain power measurement in the 1xEV-DO forward link analysis.

[[:SENSe]:FL1XEVD0:CDPower:CHANnel[:TYPE](?)

Selects or queries the channel type for the code domain power measurement in the 1xEV-DO forward link analysis.

Syntax [:SENSe]:FL1XEVD0:CDPower:CHANnel[:TYPE] { MAC | PIlot | DATA
| PREamble | OVERall }

[:SENSe]:FL1XEVD0:CDPower:CHANnel[:TYPE]?

Arguments MAC selects the MAC channel.

PIlot selects the pilot channel.

DATA selects the data channel.

PREamble selects the preamble embedded in the data.

OVERall selects the overall channels. This argument is valid when :DIS-Play:FL1XEVD0|:RL1XEVD0:DDEMod:MVIew:FORMat is IQPower.

Measurement Modes DEMFL1XEVD0

Examples :SENSe:FL1XEVD0:CDPower:CHANnel:TYPE MAC
selects the MAC channel for the code domain power measurement in the 1xEV-DO forward link analysis.

[[:SENSe]:FL1XEVD0]:RL1XEVD0:CDPower:FILTer:MEASurement(?)

Selects or queries the measurement filter for the code domain power measurement in the 1xEV-DO forward link or reverse link analysis.

Syntax `[[:SENSe]:FL1XEVD0]:RL1XEVD0:CDPower:FILTer:MEASurement { OFF
| EQComp | COMP }`
`[[:SENSe]:FL1XEVD0]:RL1XEVD0:CDPower:FILTer:MEASurement?`

Arguments OFF specifies that no measurement filter is used.
EQComp selects the Complementary filter + EQ (equalizer).
COMP selects the Complementary filter.

Measurement Modes DEMFL1XEVD0

Examples `:SENSe:FL1XEVD0:CDPower:FILTer:MEASurement COMP`
selects the Complementary filter for the code domain power measurement in the 1xEV-DO forward link analysis.

[[:SENSe]:FL1XEVD0]:RL1XEVD0:CDPower:IQSWap(?)

Sets or queries whether to enable or disable IQ swapping for the code domain power measurement in the 1xEV-DO forward link or reverse link analysis.

Syntax `[[:SENSe]:FL1XEVD0]:RL1XEVD0:CDPower:IQSWap { ON | OFF | 1 | 0 }`
`[[:SENSe]:FL1XEVD0]:RL1XEVD0:CDPower:IQSWap?`

Arguments ON or 1 enables the IQ swapping.
OFF or 0 disables the IQ swapping.

Measurement Modes DEMFL1XEVD0, DEMRL1XEVD0

Examples `:SENSe:FL1XEVD0:CDPower:IQSWap ON`
sets the IQ swapping to ON for the code domain power measurement in the 1xEV-DO forward link analysis.

[:SENSe]:RL1XEVD0:CDPower:LCMask:I(?)

Sets or queries the 11-digit mask of the I long code for the code domain power measurement in the 1xEV-DO reverse link analysis.

Syntax [:SENSe]:RL1XEVD0:CDPower:LCMask:I <num1>,<num2>,<num3>

[:SENSe]:RL1XEVD0:CDPower:LCMask:I?

Arguments <num1> is the upper 3 digits of the I long code mask.
Range: #H0 (0) to #H3FF (1023)

<num2> is the middle 4 digits of the I long code mask.
Range: #H0000 (0) to #HFFFF (65535).

<num3> is the lower 4 digits of the I long code mask.
Range: #H0000 (0) to #HFFFF (65535).

Measurement Modes DEMRL1XEVD0

Examples :SENSe:RL1XEVD0:CDPower:LCMask:I 3FF,FFFF,FFFF
sets the 11-digit mask of the I long code to 3FFFFFFFFF for the code domain power measurement in the 1xEV-DO reverse link analysis.

[[:SENSe]:RL1XEVD0:CDPower:LCMask:Q(?)

Sets or queries the 11-digit mask of the Q long code for the code domain power measurement in the 1xEV-DO reverse link analysis.

Syntax [[:SENSe]:RL1XEVD0:CDPower:LCMask:Q <num1>,<num2>,<num3>

[[:SENSe]:RL1XEVD0:CDPower:LCMask:Q?

Arguments <num1> is the upper 3 digits of the Q long code mask.

Range: #H0 (0) to #H3FF (1023)

<num2> is the middle 4 digits of the Q long code mask.

Range: #H0000 (0) to #HFFFF (65535).

<num3> is the lower 4 digits of the Q long code mask.

Range: #H0000 (0) to #HFFFF (65535).

Measurement Modes DEMRL1XEVD0

Examples :SENSe:RL1XEVD0:CDPower:LCMask:Q 3FF,FFFF,FFFF
sets the 11-digit mask of the Q long code to 3FFFFFFFFF for the code domain power measurement in the 1xEV-DO reverse link analysis.

[:SENSE] :FL1XEVD0 | RL1XEVD0 :CDPower :MLEVel (?)

Sets or queries the measurement level for the code domain power measurement in the 1xEV-DO forward link or reverse link analysis. This command is only available when :DISPlay:FL1XEVD0 | RL1XEVD0 :DDEMod:MVIEw:FORMat is IQPower.

Syntax [:SENSE] :FL1XEVD0 | RL1XEVD0 :CDPower :MLEVel { CHIP | SYMBol }
[:SENSE] :FL1XEVD0 | RL1XEVD0 :CDPower :MLEVel ?

Arguments CHIP selects the chip measurement level.
SYMBol selects the symbol measurement level.

Measurement Modes DEMFL1XEVD0, DEMRL1XEVD0

Examples :SENSE:FL1XEVD0:CDPower:MLEVel CHIP
sets the measurement level to chip for the code domain power measurement in the 1xEV-DO forward link analysis.

Related Commands :DISPlay:FL1XEVD0 | RL1XEVD0 :DDEMod:MVIEw:FORMat

[:SENSE] :FL1XEVD0 :CDPower :PNOFFset (?)

Sets or queries the PN offset for the code domain power measurement in the 1xEV-DO forward link analysis.

Syntax [:SENSE] :FL1XEVD0 :CDPower :PNOFFset <value>
[:SENSE] :FL1XEVD0 :CDPower :PNOFFset ?

Arguments <value>::=<NR1> specifies the PN offset in the unit of 64 chips.
Range: 0 to 511

Measurement Modes DEMFL1XEVD0

Examples :SENSE:FL1XEVD0:CDPower:PNOFFset 100
sets the PN offset to 100 for the code domain power measurement in the 1xEV-DO forward link analysis.

[[:SENSe]:FL1XEVD0]:RL1XEVD0:CDPower:SElect:CODE(?)

Sets or queries the code in the half slot for the code domain power measurement in the 1xEV-DO forward or reverse link analysis.

Syntax [[:SENSe]:FL1XEVD0]:RL1XEVD0:CDPower:SElect:CODE <value>

[[:SENSe]:FL1XEVD0]:RL1XEVD0:CDPower:SElect:CODE?

Arguments <value> ::= <NR1> specifies the code in the half slot. The range is shown in Table 2-116:

Table 2-116: Code range

Link	Channel type	Range
FL1XEVD0	Pilot	0 to 31
	MAC	0 to 63
	Data	0 to 15
	Preamble	0 to 31
RL1XEVD0	-	0 to 15

Measurement Modes DEMFL1XEVD0, DEMRL1XEVD0

Examples :SENSe:FL1XEVD0:CDPower:SElect:CODE 30
sets the code in the half slot to 30 for the code domain power measurement in the 1xEV-DO forward link analysis.

[[:SENSE]:FL1XEVD0|:RL1XEVD0:CDPower:SElect:HSLot(?)

Sets or queries the half slot for the code domain power measurement in the 1xEV-DO forward or reverse link analysis.

Syntax [:SENSE]:FL1XEVD0|:RL1XEVD0:CDPower:SElect:HSLot <value>
 [:SENSE]:FL1XEVD0|:RL1XEVD0:CDPower:SElect:HSLot?

Arguments <value>: :=<NR1> specifies the half slot.
 Range: -(number of analyzed chips -1) to 0

Measurement Modes DEMFL1XEVD0, DEMRL1XEVD0

Examples :SENSE:FL1XEVD0:CDPower:SElect:HSLot -10
 sets the half slot to -10 for the code domain power measurement in the 1xEV-DO forward link analysis.

[[:SENSe]:FL1XEVD0]:RL1XEVD0:CHPower Subgroup**1xEV-DO, Option 26 Only**

The [[:SENSe]:FL1XEVD0]:RL1XEVD0:CHPower commands set up the conditions related to the channel power measurement in the 1xEV-DO forward or reverse link analysis.

NOTE. To use a command from this group, you must have selected *DEMFL1XEVD0* (1xEV-DO forward link analysis) or *DEMRL1XEVD0* (1xEV-DO reverse link analysis) using the *:INSTRument[:SElect]* command.

Command Tree	Header	Parameter
	[[:SENSe]	
	:FL1XEVD0]:RL1XEVD0	
	:CHPower	
	:Bandwidth]:BWidth	
	:INtegration	<numeric_value>
	:FiLter	
	:COEfficient	<numeric_value>
	:TYpe	RECTangle GAUSSian NYQuist RNYQuist
	:LiMit	
	[:STATe]	<boolean>

[[:SENSE]:FL1XEVD0|:RL1XEVD0:CHPower:BANDwidth]:BWIDth:INTegration(?)

Sets or queries the channel bandwidth for the channel power measurement in the 1xEV-DO forward or reverse link analysis.

Syntax [[:SENSE]:FL1XEVD0|:RL1XEVD0:CHPower:BANDwidth]:BWIDth
:INTegration <value>

[[:SENSE]:FL1XEVD0|:RL1XEVD0:CHPower:BANDwidth]:BWIDth
:INTegration?

Arguments <value>::=<Nrf> specifies the channel bandwidth for the channel power measurement. Range: Span/20 to full span [Hz].

Measurement Modes DEMFL1XEVD0, DEMRL1XEVD0

Examples :SENSE:FL1XEVD0:CHPower:BANDwidth:INTegration 2.5MHz
sets the channel bandwidth to 2.5 MHz for the channel power measurement in the 1xEV-DO forward link analysis.

[[:SENSE]:FL1XEVD0|:RL1XEVD0:CHPower:FILTer:COEFFicient(?)

Sets or queries the filter roll-off rate for the channel power measurement in the 1xEV-DO forward or reverse link analysis. This command is valid when NYQuist or RNYQuist is selected in the [[:SENSE]:Standard:CHPower FILTer:TYPE command.

Syntax [[:SENSE]:FL1XEVD0|RL1XEVD0:CHPower:FILTer:COEFFicient <value>

[[:SENSE]:FL1XEVD0|RL1XEVD0:CHPower:FILTer:COEFFicient?

Arguments <value>::=<Nrf> specifies the roll-off rate.
Range: 0.0001 to 1 (default: 0.5).

Measurement Modes DEMFL1XEVD0, DEMRL1XEVD0

Examples :SENSE:FL1XEVD0:CHPower:FILTer:COEFFicient 0.1
sets the filter roll-off rate to 0.1 for the channel power measurement in the 1xEV-DO forward link analysis.

[[:SENSe]:FL1XEVD0]:RL1XEVD0:CHPower:FILTer:TYPE(?)

Select or queries the filter for the channel power measurement in the 1xEV-DO forward or reverse link analysis.

Syntax [:SENSe]:FL1XEVD0]:RL1XEVD0:CHPower:FILTer:TYPE { RECTangle
 | GAUSSian | NYQuist | RNYQuist }

[:SENSe]:FL1XEVD0]:RL1XEVD0:CHPower:FILTer:TYPE?

Arguments RECTangle selects the rectangular filter.

 GAUSSian selects the Gaussian filter.

 NYQuist selects the Nyquist filter.

 RNYQuist selects the Root Nyquist filter.

Measurement Modes DEMFL1XEVD0, DEMRL1XEVD0

Examples :SENSe:FL1XEVD0:CHPower:FILTer:TYPE NYQuist
 selects the Nyquist filter for the channel power measurement in the 1xEV-DO
 forward link analysis.

[[:SENSE]:FL1XEVD0]:RL1XEVD0:CHPower:LIMit[:STATe](?)

Sets or queries whether to enable or disable the limit testing for the channel power measurement in the 1xEV-DO forward or reverse link analysis.

Syntax [:SENSE]:FL1XEVD0|:RL1XEVD0:CHPower:LIMit[:STATe] { ON | OFF
 | 1 | 0 }

[:SENSE]:FL1XEVD0|:RL1XEVD0:CHPower:LIMit[STATe]?

Arguments ON or 1 enables the limit testing.
 OFF or 0 disables the limit testing.

Measurement Modes DEMFL1XEVD0, DEMRL1XEVD0

Examples :SENSE:FL1XEVD0:CHPower:LIMit:STATe ON
 enables the limit testing for the channel power measurement in the 1xEV-DO forward link analysis.

[[:SENSe]:FL1XEVD0]:RL1XEVD0:IM Subgroup**1xEV-DO, Option 26 Only**

The [[:SENSe]:Standard:IM] commands set up the conditions related to the intermodulation measurement in the 1xEV-DO forward or reverse link analysis.

NOTE. To use a command from this group, you must have selected *DEMFL1XEVD0* (1xEV-DO forward link analysis) or *DEMRL1XEVD0* (1xEV-DO reverse link analysis) using the *:INSTRument[:SElect]* command.

Command Tree	Header	Parameter
	[[:SENSe]	
	:FL1XEVD0]:RL1XEVD0	
	:IM	
	:BAWdwidth]:BWIDTH	
	:INTEgration	<numeric_value>
	:FILTer	
	:COEFFicient	<numeric_value>
	:TYPE	RECTangle GAUSSian NYQuist RNYQuist
	:LIMit	
	:FORDER	
	[:STATE]	<boolean>
	:TORDER	
	[:STATE]	<boolean>
	:SCOFFset	<numeric_value>

[[:SENSE]:FL1XEVD0|:RL1XEVD0:IM:BANDwidth]:BWIDth:INTegration(?)

Sets or queries the channel bandwidth for the intermodulation measurement in the 1xEV-DO forward or reverse link analysis.

Syntax [[:SENSE]:FL1XEVD0|:RL1XEVD0:IM:BANDwidth]:BWIDth:INTegration <value>

[[:SENSE]:FL1XEVD0|RL1XEVD0:IM:BANDwidth]:BWIDth:INTegration?

Arguments <value>::=<Nrf> specifies the bandwidth of the main channel for the intermodulation measurement. Range: Span/20 to full span [Hz].

Measurement Modes DEMFL1XEVD0, DEMRL1XEVD0

Examples :SENSE:FL1XEVD0:IM:BANDwidth:INTegration 2.5MHz
sets the channel bandwidth to 2.5 MHz for the intermodulation measurement in the 1xEV-DO forward link analysis.

[[:SENSE]:FL1XEVD0|:RL1XEVD0:IM:FILTer:COEFFicient(?)

Sets or queries the filter roll-off rate for the intermodulation measurement in the 1xEV-DO forward or reverse link analysis. This command is valid when NYQuist or RNYQuist is selected in the [[:SENSE]:FL1XEVD0|:RL1XEVD0:IM:FILTer:TYPE command.

Syntax [[:SENSE]:FL1XEVD0|:RL1XEVD0:IM:FILTer:COEFFicient <value>

[[:SENSE]:FL1XEVD0|:RL1XEVD0:IM:FILTer:COEFFicient?

Arguments <value>::=<Nrf> specifies the roll-off rate.
Range: 0.0001 to 1 (default: 0.5).

Measurement Modes DEMFL1XEVD0, DEMRL1XEVD0

Examples :SENSE:FL1XEVD0:IM:FILTer:COEFFicient 0.1
sets the filter roll-off rate to 0.1 for the intermodulation measurement in the 1xEV-DO forward link analysis.

Related Commands [[:SENSE]:FL1XEVD0|RL1XEVD0:IM:FILTer:TYPE

[[:SENSe]:FL1XEVD0]:RL1XEVD0:IM:FILTer:TYPE(?)

Select or queries the filter for the intermodulation measurement in the 1xEV-DO forward or reverse link analysis.

Syntax [:SENSe]:FL1XEVD0]:RL1XEVD0:IM:FILTer:TYPE { RECTangle | GAUSsian
 | NYQuist | RNYQuist }
[:SENSe]:FL1XEVD0]:RL1XEVD0:IM:FILTer:TYPE?

Arguments RECTangle selects the rectangular filter.
 GAUSsian selects the Gaussian filter.
 NYQuist selects the Nyquist filter.
 RNYQuist selects the Root Nyquist filter.

Measurement Modes DEMFL1XEVD0, DEMRL1XEVD0

Examples :SENSe:FL1XEVD0:IM:FILTer:TYPE NYQuist
 selects the Nyquist filter for the intermodulation measurement in the 1xEV-DO forward link analysis.

[[:SENSE]:FL1XEVD0]:RL1XEVD0:IM:LIMit:FORDER[:STATE](?)

Sets or queries whether to enable or disable the fifth order limit testing for the intermodulation measurement in the 1xEV-DO forward or reverse link analysis.

Syntax [[:SENSE]:FL1XEVD0]:RL1XEVD0:IM:LIMit:FORDER[:STATE] { ON | OFF
| 1 | 0 }
[[:SENSE]:FL1XEVD0]:RL1XEVD0:IM:LIMit:FORDER[:STATE]?

Arguments ON or 1 enables the fifth order limit testing.
OFF or 0 disables the fifth order limit testing.

Measurement Modes DEMFL1XEVD0, DEMRL1XEVD0

Examples :SENSE:FL1XEVD0:IM:LIMit:FORDER:STATE ON
enables the fifth order limit testing for the intermodulation measurement in the 1xEV-DO forward link analysis.

[[:SENSE]:FL1XEVD0]:RL1XEVD0:IM:LIMit:TORDER[:STATE](?)

Sets or queries whether to enable or disable the third order limit testing for the intermodulation measurement in the 1xEV-DO forward or reverse link analysis.

Syntax [[:SENSE]:FL1XEVD0]:RL1XEVD0:IM:LIMit:TORDER[:STATE] { ON | OFF
| 1 | 0 }
[[:SENSE]:FL1XEVD0]:RL1XEVD0:IM:LIMit:TORDER[:STATE]?

Arguments ON or 1 enables the third order limit testing.
OFF or 0 disables the third order limit testing.

Measurement Modes DEMFL1XEVD0, DEMRL1XEVD0

Examples :SENSE:FL1XEVD0:IM:LIMit:TORDER:STATE ON
enables the third order limit testing for the intermodulation measurement in the 1xEV-DO forward link analysis.

[[:SENSe]:FL1XEVD0]:RL1XEVD0:IM:SCOFFset(?)

Sets or queries the second channel frequency for the intermodulation measurement in the 1xEV-DO forward or reverse link analysis.

Syntax [:SENSe]:FL1XEVD0|:RL1XEVD0:IM:SCOFFset <value>

[:SENSe]:FL1XEVD0|:RL1XEVD0:IM:SCOFFset?

Arguments <value>: :=<NRf> specifies the second channel frequency for the intermodulation. Range: -span/2 to +span/2 [Hz].

Measurement Modes DEMFL1XEVD0, DEMRL1XEVD0

Examples :SENSe:FL1XEVD0:IM:SCOFFset 1.5MHz
sets the second channel frequency to 1.5 MHz for the intermodulation measurement in the 1xEV-DO forward link analysis.

[:SENSE]:FL1XEVD0|:RL1XEVD0:MACCuracy Subgroup 1xEV-DO, Option 26 Only

The [:SENSE]:FL1XEVD0|:RL1XEVD0:MACCuracy commands set up the conditions related to the modulation accuracy measurement in the 1xEV-DO forward or reverse link analysis.

NOTE. To use a command from this group, you must have selected DEMFL1XEVD0 (cdma2000 forward link analysis) or DEMRL1XEVD0 (cdma2000 reverse link analysis) using the :INSTRument[:SElect] command.

Command Tree	Header	Parameter
	[:SENSE]	
	:FL1XEVD0 :RL1XEVD0	
	:MACCuracy	
	:ACCThreshold	<numeric_value>
	:CHANnel	
	[:TYPE]	MAC PIlot DATA PREamble
	:FILTer	
	:MEASurement	OFF EQComp COMP
	:IQSWAap	<boolean>
	:LCMask	
	:I	<num1>,<num2>,<num3>
	:Q	<num1>,<num2>,<num3>
	:LIMit	
	:EVM	
	:RMS	
	[:STATE]	<boolean>
	:PEAK	
	[:STATE]	<boolean>
	:PCDerror	
	[:STATE]	<boolean>
	:RHO	
	[:STATE]	<boolean>
	:TAU	
	[:STATE]	<boolean>
	:MLEVel	CHIP SYMBol
	:PNOFfset	<numeric_value>
	:SElect	
	:CODE	<numeric_value>
	:HSLot	<numeric_value>

[[:SENSe]:FL1XEVD0]:RL1XEVD0:MACCuracy:ACCThreshold(?)

Sets or queries the active channel threshold level (in dB from the pilot), which is used for deciding whether a code channel is active or inactive, for the modulation accuracy measurement in the 1xEV-DO forward link or reverse link analysis.

Syntax [:SENSe]:FL1XEVD0|:RL1XEVD0:MACCuracy:ACCThreshold <value>
[:SENSe]:FL1XEVD0|:RL1XEVD0:MACCuracy:ACCThreshold?

Arguments <value>::=<NRf> specifies the active channel threshold level.
Range: -100 to 0 dB

Measurement Modes DEMFL1XEVD0, DEMRL1XEVD0

Examples :SENSe:FL1XEVD0:MACCuracy:ACCThreshold -100dB
sets the active channel threshold level to -100 dB for the modulation accuracy measurement in the 1xEV-DO forward link analysis.

[[:SENSE]:FL1XEVD0:MACCuracy:CHANnel[:TYPE](?)

Selects or queries the channel type for the modulation accuracy measurement in the 1xEV-DO forward link analysis.

Syntax [:SENSE]:FL1XEVD0:MACCuracy:CHANnel[:TYPE] { MAC | PILOt | DATA
| PREAmbLe | OVERa11 }

[:SENSE]:FL1XEVD0:MACCuracy:CHANnel[:TYPE]?

Arguments MAC selects the MAC channel.

PILOt selects the pilot channel.

DATA selects the data channel.

PREAmbLe selects the preamble embedded in the data.

OVERa11 selects the overall channels. This argument is only available when the [:SENSE]:FL1XEVD0[:RL1XEVD0]:MACCuracy:MLEVel command is set to CHIP.

Measurement Modes DEMFL1XEVD0

Examples :SENSE:FL1XEVD0:MACCuracy:CHANnel:TYPE MAC
select the MAC channel for the modulation accuracy measurement in the 1xEV-DO forward link analysis.

[[:SENSe]:FL1XEVD0]:RL1XEVD0:MACCuracy:FILTer:MEASurement(?)

Selects or queries the measurement filter for the modulation accuracy measurement in the 1xEV-DO forward link or reverse link analysis.

Syntax `[[:SENSe]:FL1XEVD0]:RL1XEVD0:MACCuracy:FILTer:MEASurement { OFF
| EQComp | COMP }`

`[[:SENSe]:FL1XEVD0]:RL1XEVD0:MACCuracy:FILTer:MEASurement?`

Arguments OFF specifies that no measurement filter is used.

EQComp selects the Complementary filter and EQ (equalizer).

COMP selects the Complementary filter.

Measurement Modes DEMFL1XEVD0, DEMRL1XEVD0

Examples `:SENSe:FL1XEVD0:MACCuracy:FILTer:MEASurement COMP`
selects the Complementary filter for the modulation accuracy measurement in the 1xEV-DO forward link analysis.

[[:SENSe]:FL1XEVD0]:RL1XEVD0:MACCuracy:IQSWap(?)

Sets or queries whether to enable or disable IQ swapping for the modulation accuracy measurement in the 1xEV-DO forward link or reverse link analysis.

Syntax `[[:SENSe]:FL1XEVD0]:RL1XEVD0:MACCuracy:IQSWap { ON | OFF | 1 | 0 }`

`[[:SENSe]:FL1XEVD0]:RL1XEVD0:MACCuracy:IQSWap?`

Arguments ON or 1 enables the IQ swapping.

OFF or 0 disables the IQ swapping.

Measurement Modes DEMFL1XEVD0, DEMRL1XEVD0

Examples `:SENSe:FL1XEVD0:MACCuracy:IQSWap ON`
sets the IQ swapping to ON for the modulation accuracy measurement in the 1xEV-DO forward link analysis.

[:SENSe]:RL1XEVD0:MACCuracy:LCMask:I(?)

Sets or queries the 11-digit mask of the I long code for the modulation accuracy measurement in the 1xEV-DO reverse link analysis.

Syntax [:SENSe]:RL1XEVD0:MACCuracy:LCMask:I <num1>,<num2>,<num3>

[:SENSe]:RL1XEVD0:MACCuracy:LCMask:I?

Arguments <num1> is the upper 3 digits of the I long code mask.
Range: #H0 (0) to #H3FF (1023)

<num2> is the middle 4 digits of the I long code mask.
Range: #H0000 (0) to #HFFFF (65535).

<num3> is the lower 4 digits of the I long code mask.
Range: #H0000 (0) to #HFFFF (65535).

Measurement Modes DEMRL1XEVD0

Examples :SENSe:RL1XEVD0:MACCuracy:LCMask:I 3FF,FFFF,FFFF
sets the 11-digit mask of the I long code to 3FFFFFFFFF for the modulation accuracy measurement in the 1xEV-DO reverse link analysis.

[[:SENSe]:RL1XEVD0:MACCuracy:LCMask:Q(?)

Sets or queries the 11-digit mask of the Q long code for the modulation accuracy measurement in the 1xEV-DO reverse link analysis.

Syntax [:SENSe]:RL1XEVD0:MACCuracy:LCMask:Q <num1>,<num2>,<num3>
[:SENSe]:RL1XEVD0:MACCuracy:LCMask:Q?

Arguments <num1> is the upper 3 digits of the Q long code mask.
Range: #H0 (0) to #H3FF (1023)

<num2> is the middle 4 digits of the Q long code mask.
Range: #H0000 (0) to #HFFFF (65535).

<num3> is the lower 4 digits of the Q long code mask.
Range: #H0000 (0) to #HFFFF (65535).

Measurement Modes DEMRL1XEVD0

Examples :SENSe:RL1XEVD0:MACCuracy:LCMask:Q 3FF,FFFF,FFFF
sets the 11-digit mask of the Q long code to 3FFFFFFFFF for the modulation accuracy measurement in the 1xEV-DO reverse link analysis.

[[:SENSe]:FL1XEVD0]:RL1XEVD0:MACCuracy:LIMit:EVM:PEAK[:STATe](?)

Sets or queries whether to enable or disable the PEAK EVM limit checking for the modulation accuracy measurement in the 1xEV-DO forward link or reverse link analysis.

Syntax [[:SENSe]:FL1XEVD0]:RL1XEVD0:MACCuracy:LIMit:EVM:PEAK[:STATe]
{ ON | OFF | 1 | 0 }

[[:SENSe]:FL1XEVD0]:RL1XEVD0:MACCuracy:LIMit:EVM:PEAK[:STATe]?

Arguments ON or 1 enables the peak EVM limit testing.
OFF or 0 disables the peak EVM limit testing.

Measurement Modes DEMFL1XEVD0, DEMRL1XEVD0

Examples :SENSe:FL1XEVD0:MACCuracy:LIMit:EVM:PEAK:STATe ON
enables the PEAK EVM limit testing for the modulation accuracy measurement in the 1xEV-DO forward link analysis.

[[:SENSe]:FL1XEVD0]:RL1XEVD0:MACCuracy:LIMit:EVM:RMS[:STATe](?)

Sets or queries whether to enable or disable the RMS EVM limit testing for the modulation accuracy measurement in the 1xEV-DO forward link or reverse link analysis.

Syntax [[:SENSe]:FL1XEVD0]:RL1XEVD0:MACCuracy:LIMit:EVM:RMS[:STATe]
{ ON | OFF | 1 | 0 }

[[:SENSe]:FL1XEVD0]:RL1XEVD0:MACCuracy:LIMit:EVM:RMS[:STATe]?

Arguments ON or 1 enables the RMS EVM limit testing.
OFF or 0 disables the RMS EVM limit testing.

Measurement Modes DEMFL1XEVD0, DEMRL1XEVD0

Examples :SENSe:FL1XEVD0:MACCuracy:LIMit:EVM:RMS:STATe ON
enables the RMS EVM limit testing for the modulation accuracy measurement in the 1xEV-DO forward link analysis.

[[:SENSe]:FL1XEVD0]:RL1XEVD0:MACCuracy:LIMit:PCDerror[:STATe](?)

Sets or queries whether to enable or disable the peak code domain error limit testing for the modulation accuracy measurement in the 1xEV-DO forward link or reverse link analysis.

Syntax [:SENSe]:FL1XEVD0]:RL1XEVD0:MACCuracy:LIMit:PCDerror[:STATe]
 { ON | OFF | 1 | 0 }

 [:SENSe]:FL1XEVD0]:RL1XEVD0:MACCuracy:LIMit:PCDerror[:STATe]?

Arguments ON or 1 enables the peak code domain error limit testing.
 OFF or 0 disables the peak code domain error limit testing.

Measurement Modes DEMFL1XEVD0, DEMRL1XEVD0

Examples :SENSe:FL1XEVD0:MACCuracy:LIMit:PCDerror:STATe ON
 enables the peak code domain error limit testing for the modulation accuracy measurement in the 1xEV-DO forward link analysis.

[[:SENSe]:FL1XEVD0]:RL1XEVD0:MACCuracy:LIMit:RHO[:STATe](?)

Sets or queries whether to enable or disable the Rho limit testing for the modulation accuracy measurement in the 1xEV-DO forward link or reverse link analysis.

Syntax [:SENSe]:FL1XEVD0]:RL1XEVD0:MACCuracy:LIMit:RHO[:STATe]
 { ON | OFF | 1 | 0 }

 [:SENSe]:FL1XEVD0]:RL1XEVD0:MACCuracy:LIMit:RHO[:STATe]?

Arguments ON or 1 enables the Rho limit testing.
 OFF or 0 disables the Rho limit testing.

Measurement Modes DEMFL1XEVD0, DEMRL1XEVD0

Examples :SENSe:FL1XEVD0:MACCuracy:LIMit:RHO:STATe ON
 enables the Rho limit testing for the modulation accuracy measurement in the 1xEV-DO forward link analysis.

[[:SENSE]:FL1XEVD0:MACCuracy:LIMit:TAU[:STATE](?)

Sets or queries whether to enable or disable the Tau limit testing for the modulation accuracy measurement in the 1xEV-DO forward link analysis.

Syntax [[:SENSE]:FL1XEVD0:MACCuracy:LIMit:TAU[:STATE] { ON | OFF
| 1 | 0 }
[[:SENSE]:FL1XEVD0:MACCuracy:LIMit:TAU[:STATE]?

Arguments ON or 1 enables the Tau limit testing.
OFF or 0 disables the Tau limit testing.

Measurement Modes DEMFL1XEVD0

Examples :SENSE:FL1XEVD0:MACCuracy:LIMit:TAU:STATE ON
enables the Tau limit testing for the modulation accuracy measurement in the 1xEV-DO forward link analysis.

[[:SENSE]:FL1XEVD0|:RL1XEVD0:MACCuracy:MLEVel(?)

Sets or queries the measurement level for the modulation accuracy measurement in the 1xEV-DO forward link or reverse link analysis.

Syntax [[:SENSE]:FL1XEVD0|:RL1XEVD0:MACCuracy:MLEVel { CHIP | SYMBol }
[[:SENSE]:FL1XEVD0|:RL1XEVD0:MACCuracy:MLEVel?

Arguments CHIP selects the chip measurement level.
SYMBol selects the symbol measurement level.

Measurement Modes DEMFL1XEVD0, DEMRL1XEVD0

Examples :SENSE:FL1XEVD0:MACCuracy:MLEVel CHIP
sets the measurement level to CHIP for the modulation accuracy measurement in the 1xEV-DO forward link analysis.

[[:SENSe]:FL1XEVD0:MACCuracy:PNOffset(?)

Sets or queries the PN offset for the modulation accuracy measurement in the 1xEV-DO forward link analysis.

Syntax [:SENSe]:FL1XEVD0:MACCuracy:PNOffset <value>
 [:SENSe]:FL1XEVD0:MACCuracy:PNOffset?

Arguments <value>::=<NR1> specifies the PN offset. Range: 0 to 511

Measurement Modes DEMFL1XEVD0

Examples :SENSe:FL1XEVD0:MACCuracy:PNOffset 100
 sets the PN offset to 100 for the modulation accuracy measurement in the
 1xEV-DO forward link analysis.

[[:SENSe]:FL1XEVD0|:RL1XEVD0:MACCuracy:SElect:CODE(?]

Sets or queries the code in the half slot for the modulation accuracy measurement in the 1xEV-DO forward link or reverse link analysis.

Syntax [[:SENSe]:FL1XEVD0|:RL1XEVD0:MACCuracy:SElect:CODE <value>

[[:SENSe]:FL1XEVD0|:RL1XEVD0:MACCuracy:SElect:CODE?

Arguments <value>::=<NR1> specifies the code in the half slot. The range is shown in Table 2-117:

Table 2-117: Code range

Link	Channel type	Range
FL1XEVD0	Pilot	0 to 31
	MAC	0 to 63
	Data	0 to 15
	Preamble	0 to 31
RL1XEVD0	-	0 to 15

Measurement Modes DEMFL1XEVD0, DEMRL1XEVD0

Examples :SENSe:FL1XEVD0:MACCuracy:SElect:CODE 30
sets the code in the half slot to 30 for the modulation accuracy measurement in the 1xEV-DO forward link analysis.

[[:SENSe]:FL1XEVD0]:RL1XEVD0:MACCuracy:SElect:HSLot(?)

Sets or queries the half slot for the modulation accuracy measurement in the 1xEV-DO forward link or reverse link analysis.

Syntax [[:SENSe]:FL1XEVD0]:RL1XEVD0:MACCuracy:SElect:HSLot <value>

[[:SENSe]:FL1XEVD0]:RL1XEVD0:MACCuracy:SElect:HSLot?

Arguments <value>: :=<NR1> specifies the half slot.
Range: -(number of analyzed half slots -1) to 0

Measurement Modes DEMFL1XEVD0, DEMRL1XEVD0

Examples :SENSe:FL1XEVD0:MACCuracy:SElect:HSLot -10
sets the half slot to -10 for the modulation accuracy measurement in the 1xEV-DO forward link analysis.

[[:SENSE]:FL1XEVD0]:RL1XEVD0:OBWidth Subgroup**1xEV-DO, Option 26 Only**

The [[:SENSE]:FL1XEVD0]:RL1XEVD0:OBWidth commands set up the conditions related to the occupied bandwidth (OBW) measurement in the 1xEV-DO forward or reverse link analysis.

NOTE. To use a command from this group, you must have selected *DEMFL1XEVD0* (1xEV-DO forward link analysis) or *DEMRL1XEVD0* (1xEV-DO reverse link analysis) using the *:INSTRUMENT[:SELEct]* command.

Command Tree	Header	Parameter
	[[:SENSE]	
	:FL1XEVD0]:RL1XEVD0	
	:OBWidth	
	:LIMit	
	[:STATe]	<boolean>
	:PERCent	<numeric_value>

[[:SENSe]:FL1XEVD0]:RL1XEVD0:OBWidth:LIMit[:STATe](?)

Sets or queries whether to enable or disable the limit testing for the OBW measurement in the 1xEV-DO forward or reverse link analysis.

Syntax `[[:SENSe]:FL1XEVD0]:RL1XEVD0:OBWidth:LIMit[:STATe] { ON | OFF | 1 | 0 }`
`[[:SENSe]:FL1XEVD0]:RL1XEVD0:OBWidth:LIMit[:STATe]?`

Arguments ON or 1 enables the limit testing.
OFF or 0 disables the limit testing.

Measurement Modes DEMFL1XEVD0, DEMRL1XEVD0

Examples `:SENSe:FL1XEVD0:OBWidth:LIMit:STATe ON`
sets the limit testing to ON for the OBW measurement in the 1xEV-DO forward link analysis.

[[:SENSe]:FL1XEVD0]:RL1XEVD0:OBWidth:PERCent(?)

Sets or queries the occupied bandwidth for the OBW measurement in the 1xEV-DO forward or reverse link analysis.

Syntax `[[:SENSe]:FL1XEVD0]:RL1XEVD0:OBWidth:PERCent <value>`
`[[:SENSe]:FL1XEVD0]:RL1XEVD0:OBWidth:PERCent?`

Arguments `<value>::=<NRf>` specifies the occupied bandwidth.
Range: 80% to 99.99% (default: 99%).

Measurement Modes DEMFL1XEVD0, DEMRL1XEVD0

Examples `:SENSe:FL1XEVD0:OBWidth:PERCent 95PCT`
sets the occupied bandwidth to 95% for the OBW measurement in the 1xEV-DO forward link analysis.

[[:SENSE]:FL1XEVD0]:RL1XEVD0:PCCHannel Subgroup 1xEV-DO, Option 26 Only

The [[:SENSE]:FL1XEVD0]:RL1XEVD0:PCCHannel commands set up the conditions related to the pilot to code channel measurement in the 1xEV-DO forward or reverse link analysis.

NOTE. To use a command from this group, you must have selected *DEMFL1XEVD0* (1xEV-DO forward link analysis) or *DEMRL1XEVD0* (1xEV-DO reverse link analysis) using the *:INSTRUMENT[:SELEct]* command.

Command Tree	Header	Parameter
	[[:SENSE]	
	:FL1XEVD0 :RL1XEVD0	
	:PCCHannel	
	:ACCThreshold	<numeric_value>
	:CHANnel	
	[:TYPE]	MAC DATA PREamble
	:FILTer	
	:MEASurement	OFF EQComp COMP
	:IQSWap	<boolean>
	:LCMask	
	:I	<num1>,<num2>,<num3>
	:Q	<num1>,<num2>,<num3>
	:LIMit	
	:PHASe	
	[:STATe]	<boolean>
	:TIME	
	[:STATe]	<boolean>
	:PNOFFset	<numeric_value>
	:SELEct	
	:CODE	<numeric_value>
	:HSLot	<numeric_value>

[[:SENSe]:FL1XEVD0]:RL1XEVD0:PCCHannel:ACCThreshold(?)

Sets or queries the active channel threshold level (in dB from the pilot), which is used for deciding whether a code channel is active or inactive, for the pilot to code channel measurement in the 1xEV-DO forward link or reverse link analysis.

Syntax [:SENSe]:FL1XEVD0|:RL1XEVD0:PCCHannel:ACCThreshold <value>
[:SENSe]:FL1XEVD0|:RL1XEVD0:PCCHannel:ACCThreshold?

Arguments <value>::=<NRf> specifies the active channel threshold level.
Range: -100 to 0 dB

Measurement Modes DEMFL1XEVD0, DEMRL1XEVD0

Examples :SENSe:FL1XEVD0:PCCHannel:ACCThreshold -100dB
sets the active channel threshold level to -100 dB for the pilot to code channel measurement in the 1xEV-DO forward link analysis.

[[:SENSe]:FL1XEVD0:PCCHannel:CHANnel[:TYPE](?)

Selects or queries the channel type for the pilot to code channel measurement in the 1xEV-DO forward link analysis.

Syntax [:SENSe]:FL1XEVD0:PCCHannel:CHANnel[:TYPE] { MAC | DATA
| PREamble }
[:SENSe]:FL1XEVD0:PCCHannel:CHANnel[:TYPE]?

Arguments MAC selects the MAC channel.
DATA selects the data channel.
PREamble selects the preamble embedded in the data.

Measurement Modes DEMFL1XEVD0

Examples :SENSe:FL1XEVD0:PCCHannel:CHANnel:TYPE MAC
selects the MAC channel for the pilot to code channel measurement in the 1xEV-DO forward link analysis.

[[:SENSE]:FL1XEVD0|:RL1XEVD0:PCCHannel:FILTer:MEASurement(?)]

Selects or queries the measurement filter for the pilot to code channel measurement in the 1xEV-DO forward link or reverse link analysis.

Syntax [:SENSE]:FL1XEVD0|:RL1XEVD0:PCCHannel:FILTer:MEASurement { OFF
| EQComp | COMP }

[:SENSE]:FL1XEVD0|:RL1XEVD0:PCCHannel:FILTer:MEASurement?

Arguments OFF specifies that no measurement filter is used.

EQComp selects the Complementary filter and EQ (equalizer).

COMP selects the Complementary filter.

Measurement Modes DEMFL1XEVD0, DEMRL1XEVD0

Examples :SENSE:FL1XEVD0:PCCHannel:FILTer:MEASurement COMP
selects the Complementary filter for the pilot to code channel measurement in the 1xEV-DO forward link analysis.

[[:SENSE]:FL1XEVD0|:RL1XEVD0:PCCHannel:IQSWap(?)]

Sets or queries whether to enable or disable IQ swapping for the pilot to code channel measurement in the 1xEV-DO forward link or reverse link analysis.

Syntax [:SENSE]:FL1XEVD0|:RL1XEVD0:PCCHannel:IQSWap { ON | OFF | 1 | 0 }

[:SENSE]:FL1XEVD0|:RL1XEVD0:PCCHannel:IQSWap?

Arguments ON or 1 enables the IQ swapping.

OFF or 0 disables the IQ swapping.

Measurement Modes DEMFL1XEVD0, DEMRL1XEVD0

Examples :SENSE:FL1XEVD0:PCCHannel:IQSWap ON
enables IQ swapping for the pilot to code channel measurement in the 1xEV-DO forward link analysis.

[[:SENSe]:RL1XEVD0:PCCHannel:LCMask:I(?)

Sets or queries the 11-digit mask of the I long code for the pilot to code channel measurement in the 1xEV-DO reverse link analysis.

Syntax [:SENSe]:RL1XEVD0:PCCHannel:LCMask:I <num1>,<num2>,<num3>

[:SENSe]:RL1XEVD0:PCCHannel:LCMask:I?

Arguments <num1> is the upper 3 digits of the I long code mask.

Range: #H0 (0) to #H3FF (1023)

<num2> is the middle 4 digits of the I long code mask.

Range: #H0000 (0) to #HFFFF (65535).

<num3> is the lower 4 digits of the I long code mask.

Range: #H0000 (0) to #HFFFF (65535).

Measurement Modes DEMRL1XEVD0

Examples :SENSe:RL1XEVD0:PCCHannel:LCMask:I 3FF,FFFF,FFFF
sets the 11-digit mask of the I long code to 3FFFFFFFFF for the pilot to code channel measurement in the 1xEV-DO reverse link analysis.

[:SENSe]:RL1XEVD0:PCCHannel:LCMask:Q(?)

Sets or queries the 11-digit mask of the Q long code for the pilot to code channel measurement in the 1xEV-DO reverse link analysis.

Syntax [:SENSe]:RL1XEVD0:PCCHannel:LCMask:Q <num1>,<num2>,<num3>

[:SENSe]:RL1XEVD0:PCCHannel:LCMask:Q?

Arguments <num1> is the upper 3 digits of the Q long code mask.
Range: #H0 (0) to #H3FF (1023)

 <num2> is the middle 4 digits of the Q long code mask.
Range: #H0000 (0) to #HFFFF (65535).

 <num3> is the lower 4 digits of the Q long code mask.
Range: #H0000 (0) to #HFFFF (65535).

Measurement Modes DEMRL1XEVD0

Examples :SENSe:RL1XEVD0:PCCHannel:LCMask:Q 3FF,FFFF,FFFF
sets the 11-digit mask of the Q long code to 3FF, FFFF, FFFF for the pilot to code channel measurement in the 1xEV-DO reverse link analysis.

[[:SENSe]:FL1XEVD0]:RL1XEVD0:PCCHannel:LIMit:PHASe[:STATe](?)

Sets or queries whether to enable or disable the phase limit checking for the pilot to code channel measurement in the 1xEV-DO forward link or reverse link analysis.

Syntax [:SENSe]:FL1XEVD0]:RL1XEVD0:PCCHannel:LIMit:PHASe[:STATe]
 { ON | OFF | 1 | 0 }

 [:SENSe]:FL1XEVD0]:RL1XEVD0:PCCHannel:LIMit:PHASe[:STATe]?

Arguments ON or 1 enables the phase limit testing.
 OFF or 0 disables the phase limit testing.

Measurement Modes DEMFL1XEVD0, DEMRL1XEVD0

Examples :SENSe:FL1XEVD0:PCCHannel:LIMit:PHASe:STATe ON
 enables the phase limit testing for the pilot to code channel measurement in the 1xEV-DO forward link analysis.

[[:SENSe]:FL1XEVD0]:RL1XEVD0:PCCHannel:LIMit:TIME[:STATe](?)

Sets or queries whether to enable or disable the time limit testing for the pilot to code channel measurement in the 1xEV-DO forward link or reverse link analysis.

Syntax [:SENSe]:FL1XEVD0]:RL1XEVD0:PCCHannel:LIMit:TIME[:STATe]
 { ON | OFF | 1 | 0 }

 [:SENSe]:FL1XEVD0]:RL1XEVD0:PCCHannel:LIMit:TIME[:STATe]?

Arguments ON or 1 enables the time limit testing.
 OFF or 0 disables the time limit testing.

Measurement Modes DEMFL1XEVD0, DEMRL1XEVD0

Examples :SENSe:FL1XEVD0:PCCHannel:LIMit:TIME:STATe ON
 enables the time limit testing for the pilot to code channel measurement in the 1xEV-DO forward link analysis.

[[:SENSE]:FL1XEVD0:PCCHannel:PNOffset(?)]

Sets or queries the PN offset for the pilot to code channel measurement in the 1xEV-DO forward link analysis.

Syntax [:SENSE]:FL1XEVD0:PCCHannel:PNOffset <value>
 [:SENSE]:FL1XEVD0:PCCHannel:PNOffset?

Arguments <value>::=<NR1> specifies the PN offset. Range: 0 to 511

Measurement Modes DEMFL1XEVD0

Examples :SENSE:FL1XEVD0:PCCHannel:PNOffset 100
 sets the PN offset to 100 for the pilot to code channel measurement in the 1xEV-DO forward link analysis.

[[:SENSe]:FL1XEVD0]:RL1XEVD0:PCCHannel:SElect:CODE(?)

Sets or queries the code in the half slot for the pilot to code channel measurement in the 1xEV-DO forward link or reverse link analysis.

Syntax [[:SENSe]:FL1XEVD0]:RL1XEVD0:PCCHannel:SElect:CODE <value>

[[:SENSe]:FL1XEVD0]:RL1XEVD0:PCCHannel:SElect:CODE?

Arguments <value>::=<NR1> specifies the code in the half slot. The range is shown in Table 2-116:

Table 2-118: Code range

Link	Channel type	Range
FL1XEVD0	MAC	0 to 1
	Data	0 to 15
	Preamble	0
RL1XEVD0	-	0, 0 to 1, 0 to 2, or 0 to 3

Measurement Modes DEMFL1XEVD0, DEMRL1XEVD0

Examples :SENSe:FL1XEVD0:PCCHannel:SElect:CODE 1
sets the code in the half slot to 1 for the pilot to code channel measurement in the 1xEV-DO forward link analysis.

[[:SENSE]:FL1XEVD0|:RL1XEVD0:PCCHannel:SElect:HSLot(?)]

Sets or queries the half slot for the pilot to code channel measurement in the 1xEV-DO forward link or reverse link analysis.

Syntax [:SENSE]:FL1XEVD0|:RL1XEVD0:PCCHannel:SElect:HSLot <value>
 [:SENSE]:FL1XEVD0|:RL1XEVD0:PCCHannel:SElect:HSLot?

Arguments <value>: :=<NR1> specifies the half slot.
 Range: -(number of analyzed half slots - 1) to 0

Measurement Modes DEMFL1XEVD0, DEMRL1XEVD0

Examples :SENSE:FL1XEVD0:PCCHannel:SElect:HSLot -10
 sets the half slot to -10 for the pilot to code channel measurement in the 1xEV-DO forward link analysis.

[[:SENSe]:FL1XEVD0:PVTIME Subgroup**1xEV-DO, Option 26 Only**

The [[:SENSe]:FL1XEVD0:PVTIME commands set up the conditions related to the gated output power measurement in the 1xEV-DO forward link analysis. These commands are only available for the FL1XEVD0 FL1XEVD0[:RL1XEVD0].

NOTE. To use a command from this group, you must have selected DEMFL1XEVD0 (cdma2000 forward link analysis) or DEMRL1XEVD0 (cdma2000 reverse link analysis) using the :INSTRUMENT[:SELEct] command.

Command Tree	Header	Parameter
	[[:SENSe]	
	:FL1XEVD0	
	:PVTIME	
	:BURSt	
	:OFFSet	<numeric_value>
	:SYNC	REDGe MPOint TPOStion
	:LIMit	
	:ZONE<x>	
	[:STATe]	<boolean>
	:RCHannel	
	:LEVe1	<numeric_value>
	:MODE	AUTO MANua1
	:SLOT	
	[:TYPE]	IDLE ACTive

[[:SENSE]:FL1XEVD0:PVTIME:BURSt:OFFSet(?)]

Sets or queries the burst offset between the trigger position and burst position for the gated output power measurement in the 1xEV-DO forward link analysis. This command is only available when [[:SENSE]:FL1XEVD0:PVTIME:SLOT[:TYPE]] is IDLE and [[:SENSE]:FL1XEVD0:PVTIME:BURSt:SYNC] is TPOStion.

Syntax [[:SENSE]:FL1XEVD0:PVTIME:BYRSt:OFFSet <value>
[[:SENSE]:FL1XEVD0:PVTIME:BURSt:OFFSet?

Arguments <value>::=<NRf> specifies the burst offset.
Range: -0.001 to 0.001 [s]

Measurement Modes DEMFL1XEVD0

Examples :SENSE:FL1XEVD0:PVTIME:BURSt:OFFSet 100us
sets the burst offset to 100 ms for the gated output power measurement in the 1xEV-DO forward link analysis.

Related Commands [[:SENSE]:FL1XEVD0:PVTIME:SLOT[:TYPE]],
[[:SENSE]:FL1XEVD0:PVTIME:BURSt:SYNC]

[[:SENSe]:FL1XEVD0:PVTime:BURSt:SYNC(?)]

Sets or queries the burst sync for the gated output power measurement in the 1xEV-DO forward link analysis. This command is only available when the [:SENSe]:FL1xEVD0:PVTime:SLOT[:TYPE] command is set to IDLE.

Syntax [:SENSe]:FL1XEVD0:PVTime:BURSt:SYNC { REDGe | MP0int
 | TPOStion }

[:SENSe]:FL1XEVD0:PVTime:BURSt:SYNC?

Arguments REDGe specifies the rising edge.
 MP0int specifies the middle point.
 TPOStion specifies the trigger position.

Measurement Modes DEMFL1XEVD0

Examples :SENSe:FL1XEVD0:PVTime:BURSt:SYNC TPOStion
 sets the burst sync to the trigger position for the gated output power measurement in the 1x EV-DO forward link analysis.

Related Commands [:SENSe]:FL1XEVD0:PVTime:SLOT[:TYPE]

[[:SENSe]:FL1XEVD0:PVTIme:LIMit:ZONE[:STATe](?)

Sets or queries whether to enable or disable the zone limit testing for the gated output power measurement in the 1xEV-DO forward link analysis.

Syntax [:SENSe]:FL1XEVD0:PVTIme:LIMit:ZONE<x>[:STATe] { ON | OFF
 | 1 | 0 }

[:SENSe]:FL1XEVD0:PVTIme:LIMit:ZONE<x>[:STATe]?

Where Zone<x> (x=1 to 5) correspond to Zones A, B, C, D, and E in the limit editor, respectively.

Arguments ON or 1 enables the zone limit testing.

OFF or 0 disables the zone limit testing.

Measurement Modes DEMFL1XEVD0

Examples :SENSe:FL1XEVD0:PVTIme:LIMit:ZONE1 ON
 enables the limit testing of zone 1 for the gated output power measurement in the 1xEV-DO forward link analysis.

[[:SENSe]:FL1XEVD0:PVTime:RCHannel:LEVel(?)]

Sets or queries the reference channel level to measure the power level in dB. This command is valid when [[:SENSe]:FL1XEVD0:PVTime:RCHannel:MODE] is MANual.

Syntax [[:SENSe]:FL1XEVD0:PVTime:RCHannel:LEVel <value>
[[:SENSe]:FL1XEVD0:PVTime:RCHannel:LEVel?

Arguments <value>::=<NRf> specifies the reference channel level. Range: -150 to 30 dBm

Measurement Modes DEMFL1XEVD0

Examples :SENSe:FL1XEVD0:PVTime:RCHannel:LEVel -10dBm
sets the reference channel level to -10 dBm for the gated output power measurement in the 1xEV-DO forward link analysis.

Related Commands [[:SENSe]:FL1XEVD0:PVTime:RCHannel:MODE]

[[:SENSe]:FL1XEVD0:PVTIme:RCHannel:MODE(?)]

Sets or queries the mode of the reference channel level to measure the power level in dB.

Syntax [[:SENSe]:FL1XEVD0:PVTIme:RCHannel:MODE { AUTO | MANua1 }

[[:SENSe]:FL1XEVD0:PVTIme:RCHannel:MODE?

Arguments AUTO the reference level is measured from the input signal.

MANua1 the reference level can be defined by the [[:SENSe]:FL1XEVD0:PVTIme:RCHannel:LEVel] command.

Measurement Modes DEMFL1XEVD0

Examples :SENSe:FL1XEVD0:PVTIme:RCHannel:MODE AUTO
sets the mode of the reference channel level to AUTO for the gated output power measurement in the 1xEV-DO forward link analysis.

Related Commands [[:SENSe]:FL1XEVD0:PVTIme:RCHannel:LEVel]

[[:SENSe]:FL1XEVD0:PVTIme:SLOT[:TYPE](?)]

Sets or queries the slot type for the gated output power measurement in the 1xEV-DO forward link analysis.

Syntax [[:SENSe]:FL1XEVD0:PVTIme:SLOT { IDLE | ACTIve }

[[:SENSe]:FL1XEVD0:PVTIme:SLOT?

Arguments IDLE selects the idle slot including the pilot and MAC channels.

ACTIve selects the active slot including the pilot, MAC, and data channels.

Measurement Modes DEMFL1XEVD0

Examples :SENSe:FL1XEVD0:PVTIme:REFeRence:SLOT:TYPE IDLE
sets the slot type to IDLE for the gated output power measurement in the 1xEV-DO forward link analysis.

[[:SENSe]:FL1XEVD0]:RL1XEVD0:SEMAsk Subgroup**1xEV-DO, Option 26 Only**

The [[:SENSe]:FL1XEVD0]:RL1XEVD0:SEMAsk commands set up the conditions related to the spectrum emission mask measurement in the 1xEV-DO forward link or reverse link analysis.

NOTE. To use a command from this group, you must have selected *DEMFL1XEVD0* (1xEV-DO forward link analysis) or *DEMRL1XEVD0* (1xEV-DO reverse link analysis) using the *:INSTRument[:SElect]* command.

Command Tree	Header	Parameter
	[[:SENSe]	
	:FL1XEVD0]:RL1XEVD0	
	:SEMAsk	
	:BAWdwidth]:BWIth	
	:INTEgration	<numeric_value>
	:BURSt	
	:OFFSet	<numeric_value>
	:SYNC	REDGe MPOint TPOsition
	:FILTer	
	:COEFFicient	<numeric_value>
	:TYPE	RECTangle GAUSSian NYQuist RNYQuist
	:LIMit	
	:ISPurious	
	:ZONE<x>	
	[:STATe]	<boolean>
	:OFCHannel	
	:ZONE<x>	
	[:STATe]	<boolean>
	:MEASurement	OFCHannel ISPurious
	:RCHannel	
	:LEVeL	<numeric_value>
	:MODE	AUTO MAnual
	:SLOT	
	:GATE	<numeric_value>
	[::TYPE]	IDLE ACTive

[[:SENSE]:FL1XEVD0|:RL1XEVD0:SEMask:BANDwidth]:BWIDth:INTegration(?)

Sets or queries the channel bandwidth for the spectrum emission mask measurement in the 1xEV-DO forward or reverse link analysis.

Syntax [[:SENSE]:FL1XEVD0|:RL1XEVD0:SEMask:BANDwidth]:BWIDth:INTegration <value>

[[:SENSE]:FL1XEVD0|:RL1XEVD0:SEMask:BANDwidth]:BWIDth:INTegration?

Arguments <value>::=<Nrf> specifies the channel bandwidth.
Range: Span/20 to full span [Hz].

Measurement Modes DEMFL1XEVD0, DEMRL1XEVD0

Examples :SENSE:FL1XEVD0:SEMask:BANDwidth:INTegration 2.5MHz
sets the channel bandwidth to 2.5 MHz for the spectrum emission mask measurement in the 1xEV-DO forward link analysis.

[[:SENSe]:FL1XEVD0:SEMAsk:BURSt:OFFSet(?)]

Sets or queries the burst offset between the trigger position and burst position for the spectrum emission mask measurement in the 1xEV-DO forward or reverse link analysis. This command is valid when [[:SENSe]:FL1XEVD0:SEMAsk:SLOT[:TYPE]] is IDLE and [[:SENSe]:FL1XEVD0:SEMAsk:BURSt:SYNC] is TPOStion.

Syntax [[:SENSe]:FL1XEVD0:SEMAsk:BURSt:OFFSet <value>
[:SENSe]:FL1XEVD0:SEMAsk:BURSt:OFFSet?

Arguments <value>::=<NRf> specifies the burst offset. Range: -0.001 to 0.001 [s].

Measurement Modes DEMFL1XEVD0

Examples :SENSe:FL1XEVD0:SEMAsk:BURSt:OFFSet 100us
sets the burst offset to 100 ms for the spectrum emission mask measurement in the 1xEV-DO forward link analysis.

Related Commands [[:SENSe]:FL1XEVD0:SEMAsk:BURSt:SYNC],
[:SENSe]:FL1XEVD0:SEMAsk:SLOT[:TYPE]

[[:SENSe]:FL1XEVD0:SEMAsk:BURSt:SYNC(?]

Selects or queries the burst sync for the spectrum emission mask measurement in the 1xEV-DO forward or reverse link analysis. This command is valid when [:SENSe]:FL1XEVD0:SEMAsk:SLOT[:TYPE] is IDLE.

Syntax [:SENSe]:FL1XEVD0|:RL1XEVD0:SEMAsk:BURSt:SYNC { REDGe | MP0int
| TPOStion }

[:SENSe]:FL1XEVD0|:RL1XEVD0:SEMAsk:BURSt:SYNC?

Arguments REDGe specifies the rising edge for the burst sync.
MP0int specifies the middle point for the burst sync.
TPOStion specifies the trigger position for the burst sync.

Measurement Modes DEMFL1XEVD0

Examples :SENSe:FL1XEVD0:SEMAsk:BURSt:SYNC TPOStion
sets the burst sync to the trigger position for the spectrum emission mask measurement in the 1xEV-DO forward link analysis.

Related Commands [:SENSe]:FL1XEVD0:SEMAsk:SLOT[:TYPE]

[[:SENSe]:FL1XEVD0]:RL1XEVD0:SEMask:FILTer:COEFFicient(?)

Sets or queries the filter roll-off rate for the spectrum emission mask measurement in the 1xEV-DO forward or reverse link analysis. This command is only available when [[:SENSe]:FL1XEVD0]:RL1XEVD0:SEMask: FILTer:TYPE is NYQuist or RNYQuist.

Syntax [[:SENSe]:FL1XEVD0]:RL1XEVD0:SEMask:FILTer:COEFFicient <value>
[[:SENSe]:FL1XEVD0]:RL1XEVD0:SEMask:FILTer:COEFFicient?

Arguments <value>::=<NRf> specifies the roll-off rate.
Range: 0.0001 to 1 (default: 0.5).

Measurement Modes DEMFL1XEVD0, DEMRL1XEVD0

Examples :SENSe:FL1XEVD0:SEMask:FILTer:COEFFicient 0.1
sets the filter roll-off rate to 0.1 for the spectrum emission mask measurement in the 1xEV-DO forward link analysis.

Related Commands [[:SENSe]:FL1XEVD0]:RL1XEVD0:SEMask:FILTer:TYPE

[[:SENSE]:FL1XEVD0|:RL1XEVD0:SEMask:FILTer:TYPE(?)]

Selects or queries the filter for the spectrum emission mask measurement in the 1xEV-DO forward or reverse link analysis.

Syntax [:SENSE]:FL1XEVD0|:RL1XEVD0:SEMask:FILTer:TYPE { RECTangle
| GAUSSian | NYQuist | RNYQuist }

[:SENSE]:FL1XEVD0|:RL1XEVD0:SEMask:FILTer:TYPE?

Arguments RECTangle selects the rectangular filter.

GAUSSian selects the Gaussian filter.

NYQuist selects the Nyquist filter.

RNYQuist selects the Root Nyquist filter.

Measurement Modes DEMFL1XEVD0, DEMRL1XEVD0

Examples :SENSE:FL1XEVD0:SEMask:FILTer:TYPE NYQuist
selects the Nyquist filter for the spectrum emission measurement in the 1xEV-DO forward link analysis.

[[:SENSe]:FL1XEVD0]:RL1XEVD0:SEMAsk:LIMit:ISPurious:ZONE<x>[:STATe](?)

Sets or queries whether to enable or disable the inband spurious zone limit testing for the spectrum emission mask measurement in the 1xEV-DO forward or reverse link analysis.

Syntax [:SENSe]:FL1XEVD0]:RL1XEVD0:SEMAsk:LIMit:ISPurious:ZONE<x>
[:STATe] { ON | OFF | 1 | 0 }

[:SENSe]:FL1XEVD0]:RL1XEVD0:SEMAsk:LIMit:ISPurious:ZONE<x>
[:STATe]?

Where Zone<x> (x=1 to 5) correspond to Zone A, B, C, D, and E in the limit editor, respectively.

Arguments ON or 1 enables the inband spurious zone limit testing.

OFF or 0 disables the inband spurious zone limit testing.

Measurement Modes DEMFL1XEVD0, DEMRL1XEVD0

Examples :SENSe:FL1XEVD0:SEMAsk:LIMit:ISPurious:ZONE1:STATe ON
enables the inband spurious limit testing of zone 1 for the spectrum emission mask measurement in the 1xEV-DO forward link analysis.

[[:SENSe]:FL1XEVD0|:RL1XEVD0:SEMask:LIMit:OFCHannel:ZONE<x>[:STATe](?)

Sets or queries whether to enable or disable the offset from the channel zone limit testing for the spectrum emission mask measurement in the 1xEV-DO forward or reverse link analysis.

Syntax [:SENSe]:FL1XEVD0|:RL1XEVD0:SEMask:LIMit:OFCHannel:ZONE<x>
[:STATe] { ON | OFF | 1 | 0 }

[:SENSe]:FL1XEVD0|:RL1XEVD0:SEMask:LIMit:OFCHannel:ZONE<x>
[:STATe]?

Where ZONE<x> (x=1 to 5) correspond to Zone A, B, C, D, and E in the limit editor, respectively.

Arguments ON or 1 enables the offset from the channel zone limit testing.
OFF or 0 disables the offset from the channel zone limit testing.

Measurement Modes DEMFL1XEVD0, DEMRL1XEVD0

Examples :SENSe:FL1XEVD0:SEMask:LIMit:OFCHannel:ZONE1:STATe ON
enables the offset from the channel limit testing of zone 1 for the spectrum emission mask measurement in the 1xEV-DO forward link analysis.

[[:SENSe]:FL1XEVD0]:RL1XEVD0:SEMask:MEASurement(?)

Sets or queries the limit table type used for limit testing for the spectrum emission mask measurement in the 1xEV-DO forward or reverse link analysis.

Syntax [:SENSe]:FL1XEVD0|:RL1XEVD0:SEMask:MEASurement
 { OFCHannel | ISpurious }

[:SENSe]:FL1XEVD0|:RL1XEVD0:SEMask:MEASurement?

Arguments OFCHannel selects the Offset From Channel type where frequency zones are specified by the difference from the center frequency.

ISpurious selects the Inband Spurious type in which frequency zones are specified by the absolute values.

Measurement Modes DEMFL1XEVD0, DEMRL1XEVD0

Examples :SENSe:FL1XEVD0:SEMask:MEASurement ISpurious
 selects the Inband Spurious limit table for the spectrum emission mask measurement in the 1xEV-DO forward link analysis.

[[:SENSe]:FL1XEVD0]:RL1XEVD0:SEMask:RCHannel:LEVel(?)

Sets or queries the reference channel level to measure the spurious emission level in dBc. This command is valid when [:SENSe]:FL1XEVD0]:RL1XEVD0:SEMask:RCHannel:MODE is MANUAL.

Syntax [:SENSe]:FL1XEVD0|:RL1XEVD0:SEMask:RCHannel:LEVel <value>
 [:SENSe]:FL1XEVD0|:RL1XEVD0:SEMask:RCHannel:LEVel?

Arguments <value>::=<NRf> specifies the reference level. Range: -150 to 30 dBm.

Measurement Modes DEMFL1XEVD0, DEMRL1XEVD0

Examples :SENSe:FL1XEVD0:SEMask:RCHannel:LEVel -10dBm
 sets the reference channel level to -10 dBm for the spectrum emission mask measurement in the 1xEV-DO forward link analysis.

Related Commands [:SENSe]:FL1XEVD0]:RL1XEVD0:SEMask:RCHannel:MODE

[[:SENSe]:FL1XEVD0]:RL1XEVD0:SEMask:RCHannel:MODE(?)

Sets or queries the mode of the reference channel level to measure the spurious emission level in dBc.

Syntax [:SENSe]:FL1XEVD0|:RL1XEVD0:SEMask:RCHannel:MODE
 { AUTO | MANua1 }
 [:SENSe]:FL1XEVD0|:RL1XEVD0:SEMask:RCHannel:MODE?

Arguments AUTO specifies that the reference level is measured from the input signal.
 MANua1 allows you to set the reference level manually using the
 [:SENSe]:FL1XEVD0]:RL1XEVD0:SEMask:RCHannel:LEVel command.

Measurement Modes DEMFL1XEVD0, DEMRL1XEVD0

Examples :SENSe:FL1XEVD0:SEMask:RCHannel:MODE AUTO
 sets the mode of the reference channel level to AUTO for the spectrum emission
 mask measurement in the 1xEV-DO forward link analysis.

Related Commands [:SENSe]:FL1XEVD0]:RL1XEVD0:SEMask:RCHannel:LEVel

[[:SENSe]:FL1XEVD0]:RL1XEVD0:SEMask:SLOT:GATE(?)

Sets or queries the slot gate time for the spectrum emission mask measurement in the 1xEV-DO forward link analysis. This command is valid when the [[:SENSe]:FL1XEVD0:SEMask:SLOT[:TYPE]] is IDLE.

Syntax [[:SENSe]:FL1XEVD0]:RL1XEVD0:SEMask:SLOT:GATE <value>
[[:SENSe]:FL1XEVD0]:RL1XEVD0:SEMask:SLOT:GATE?

Arguments <value>::=<NRf> specifies the slot gate time. Range: 180 E-6 to 840 E-6 [s].

Measurement Modes DEMFL1XEVD0, DEMRL1XEVD0

Examples :SENSe:FL1XEVD0:SEMask:SLOT:GATE 200us
sets the slot gate time to 200 μ s for the spectrum emission mask measurement in the 1xEV-DO forward link analysis.

Related Commands [[:SENSe]:FL1XEVD0:SEMask:SLOT[:TYPE]]

[[:SENSe]:FL1XEVD0:SEMask:SLOT[:TYPE]](?)

Selects or queries the slot type (Idle or Active) for the spectrum emission mask measurement in the 1xEV-DO forward link analysis.

Syntax [[:SENSe]:FL1XEVD0:SEMask:SLOT[:TYPE]] { IDLE | ACTive }
[[:SENSe]:FL1XEVD0:SEMask:SLOT[:TYPE]]?

Arguments IDLE selects the idle slot including the pilot and MAC channels.
ACTive selects the active slot including the pilot, MAC, and data channels.

Measurement Modes DEMFL1XEVD0

Examples :SENSe:FL1XEVD0:SEMask:SLOT:TYPE IDLE
selects the idle slot type for the spectrum emission mask measurement in the 1xEV-DO forward link analysis.

[[:SENSE]:DLR5_3GPP Subgroup**3GPP-R5, Option 27 Only**

The [[:SENSE]:DLR5_3GPP commands set up conditions for the 3GPP-R5 downlink modulation analysis.

NOTE. To use a command from this group, you must have selected *DEMDLR5_3G* (3GPP-R5 downlink modulation analysis mode) using the *:INSTrument[:SElect]* command.

Command Tree	Header	Parameter
	[[:SENSE]	
	:DLR5_3GPP	
	:BLOCK	<numeric_value>
	:CARRier	
	:OFFSet	<frequency>
	:SEARCh	<boolean>
	:COMPosite	<boolean>
	:DTYPE	
	:SEARCh	<boolean>
	:EVM	
	:IQOffset	INCLude EXCLude
	:FILTer	
	:ALPHa	<ratio>
	:MEASurement	OFF RRCosine
	:REFerence	OFF RCOsine GAUSSian
	[[:IMMediate]	
	:LENGth	<numeric_value>
	:OFFSet	<numeric_value>
	:SCHPart	<boolean>
	:SCODE	
	:ALTerNative	NUSed PRIMary LEFT RIGHT
	:NUMBer	<code_number>
	:SEARCh	<boolean>

[[:SENSe]:DLR5_3GPP:BLOCK(?)]

Sets or queries the number of the block to measure in the 3GPP-R5 downlink analysis.

Syntax [:SENSe]:DLR5_3GPP:BLOCK <number>
 [:SENSe]:DLR5_3GPP:BLOCK?

Arguments <number>::=<NR1> specifies the block number.
 Zero represents the latest block.
 Range: -M to 0 (M: Number of acquired blocks).

Measurement Modes DEMDLR5_3G

Examples :SENSe:DLR5_3GPP:BLOCK -5
 sets the block number to -5.

[[:SENSe]:DLR5_3GPP:CARRIER:OFFSET(?)]

Sets or queries the carrier frequency offset in the 3GPP-R5 downlink analysis.

Syntax [:SENSe]:DLR5_3GPP:CARRIER:OFFSET <freq>
 [:SENSe]:DLR5_3GPP:CARRIER:OFFSET?

Arguments <freq>::=<NRf> specifies the carrier frequency offset.
 Range: -Fs to Fs (Fs: Span)

Measurement Modes DEMDLR5_3G

Examples :SENSe:DLR5_3GPP:CARRIER:OFFSET 10MHz
 sets the carrier frequency offset to 10 MHz.

[[:SENSE]:DLR5_3GPP:CARRIER:SEARCH(?)]

Determines whether to detect the carrier automatically in the 3GPP-R5 downlink analysis.

Syntax [:SENSE]:DLR5_3GPP:CARRIER:SEARCH { OFF | ON | 0 | 1 }
[:SENSE]:DLR5_3GPP:CARRIER:SEARCH?

Arguments OFF or 0 specifies that the carrier is not detected automatically. To set the carrier frequency offset, use the [:SENSE]:DLR5_3GPP:CARRIER:OFFSET command.
ON or 1 specifies that the carrier is detected automatically.

Measurement Modes DEMDLR5_3G

Examples :SENSE:DLR5_3GPP:CARRIER:SEARCH ON
specifies that the carrier is detected automatically.

Related Commands [:SENSE]:DLR5_3GPP:CARRIER:OFFSET

[[:SENSe]:DLR5_3GPP:COMPOSITE(?)]

Determines whether to perform the composite analysis (automatic detection of symbol rate) in the 3GPP-R5 downlink analysis.

Syntax [:SENSe]:DLR5_3GPP:COMPOSITE { OFF | ON | 0 | 1 }
 [:SENSe]:DLR5_3GPP:COMPOSITE?

Arguments OFF or 0 specifies that composite analysis is not performed.
 ON or 1 specifies that composite analysis is performed.

NOTE. *You should usually specify that composite analysis is performed. If a normal analysis does not result, select OFF in this command and select a specific symbol rate in :DISPlay:DLR5_3GPP:AVIew:SRATe.*

Measurement Modes DEMDLR5_3G

Examples :SENSe:DLR5_3GPP:COMPOSITE ON
 specifies that the composite analysis is performed.

Related Commands :DISPlay:DLR5_3GPP:AVIew:SRATe

[[:SENSe]:DLR5_3GPP:DTYPe:SEARch(?)

Determines whether to detect the demodulation type of the code channel (QPSK or 16QAM) automatically.

Syntax [:SENSe]:DLR5_3GPP:DTYPe:SEARch { OFF | ON | 0 | 1 }
 [:SENSe]:DLR5_3GPP:DTYPe:SEARch?

Arguments OFF or 0 specifies that the code channel is QPSK.
 ON or 1 specifies that the code channel is automatically detected (QPSK or 16QAM).

Measurement Modes DEMDLR5_3G

Examples :SENSe:DLR5_3GPP:DTYPe:SEARch ON
 specifies that the code channel is automatically detected.

[[:SENSe]:DLR5_3GPP:EVM:IQOoffset(?)

Determines whether to include the I/Q origin offset in the EVM (Error Vector Magnitude), Rho (waveform quality), and PCDE (Peak Code Domain Error) calculation.

Syntax [:SENSe]:DLR5_3GPP:EVM:IQOoffset { INCLude | EXCLude }
 [:SENSe]:DLR5_3GPP:EVM:IQOoffset?

Arguments INCLude includes the I/Q origin offset in the EVM, Rho, and PCDE calculation.
 EXCLude excludes the I/Q origin offset from the calculation.

Measurement Modes DEMDLR5_3G

Examples :SENSe:DLR5_3GPP:IQOoffset INCLude
 includes the I/Q origin offset in the calculation.

[[:SENSe]:DLR5_3GPP:FILTer:ALPHa(?)]

Sets or queries the filter factor (a/BT) in the 3GPP-R5 downlink analysis.

Syntax [[:SENSe]:DLR5_3GPP:FILTer:ALPHa <value>

[[:SENSe]:DLR5_3GPP:FILTer:ALPHa?

Arguments <value>::=<NRf> specifies the filter factor (a/BT). Range: 0 to 1.

Measurement Modes DEMDLR5_3G

Examples :SENSe:DLR5_3GPP:FILTer:ALPHa 0.5
sets the filter factor to 0.5.

[[:SENSE]:DLR5_3GPP:FILTER:MEASUREMENT(?)]

Selects or queries the measurement filter in the 3GPP-R5 downlink analysis.

Syntax [:SENSE]:DLR5_3GPP:FILTER:MEASUREMENT { OFF | RRCosine }
 [:SENSE]:DLR5_3GPP:FILTER:MEASUREMENT?

Arguments OFF specifies that no measurement filter is used.
 RRCosine selects the Root Raised Cosine filter.

Measurement Modes DEMDLR5_3G

Examples :SENSE:DLR5_3GPP:FILTER:MEASUREMENT RRCosine
 selects the Root Raised Cosine filter as the measurement filter.

[[:SENSE]:DLR5_3GPP:FILTER:REFERENCE(?)]

Selects or queries the reference filter in the 3GPP-R5 downlink analysis.

Syntax [:SENSE]:DLR5_3GPP:FILTER:REFERENCE { OFF | RCOSine | GAUSSian }
 [:SENSE]:DLR5_3GPP:FILTER:REFERENCE?

Arguments OFF specifies that no reference filter is used.
 RCOSine selects the Raised Cosine filter.
 GAUSSian selects the Gaussian filter.

Measurement Modes DEMDLR5_3G

Examples :SENSE:DLR5_3GPP:FILTER:REFERENCE RCOSine
 selects the Raised Cosine filter as the reference filter.

[[:SENSe]:DLR5_3GPP[:IMMediate] (No Query Form)

Runs the 3GPP-R5 downlink analysis calculation on the acquired data.
To acquire data, use the :INITiate command.

Syntax [:SENSe]:DLR5_3GPP[:IMMediate]

Arguments None

Measurement Modes DEMDLR5_3G

Examples :SENSe:DLR5_3GPP:IMMediate
runs the 3GPP-R5 downlink analysis calculation.

Related Commands :INITiate

[[:SENSe]:DLR5_3GPP:LENGth(?)

Defines or queries the range for the 3GPP-R5 downlink analysis.

Syntax [:SENSe]:DLR5_3GPP:LENGth <value>
[:SENSe]:DLR5_3GPP:LENGth?

Arguments <value>::=<NRf> specifies the analysis range by the number of data points.
Range: 1 to 1024 × (block size).
To set the block size, use the [:SENSe]:BSIZE command.

Measurement Modes DEMDLR5_3G

Examples :SENSe:DLR5_3GPP:LENGth 1000
sets the length of the analysis range to 1000 points.

Related Commands [:SENSe]:BSIZE

[[:SENSE]:DLR5_3GPP:OFFSet(?)]

Sets or queries the measurement start position in the 3GPP-R5 downlink analysis.

Syntax [:SENSE]:DLR5_3GPP:OFFSet <value>
 [:SENSE]:DLR5_3GPP:OFFSet?

Arguments <value>::=<NRf> specifies the measurement start position by the number of data points. Range: 0 to $1024 \times (\text{block size}) - 1$.
 To set the block size, use the [:SENSE]:BSIZE command.

Measurement Modes DEMDLR5_3G

Examples :SENSE:DLR5_3GPP:OFFSet 100
 sets the measurement start position to point 100.

Related Commands [:SENSE]:BSIZE

[[:SENSE]:DLR5_3GPP:SCHPart(?)]

Determines whether to include the SCH part in the analysis.

Syntax [:SENSE]:DLR5_3GPP:SCHPart { OFF | ON | 0 | 1 }
 [:SENSE]:DLR5_3GPP:SCHPart?

Arguments OFF or 0 specifies that the SCH part is not included in the analysis.
 ON or 1 specifies that the SCH part is included in the analysis.

Measurement Modes DEMDLR5_3G

Examples :SENSE:DLR5_3GPP:SCHPart ON
 specifies that the SCH part is included in the analysis.

[[:SENSe]:DLR5_3GPP:SCODE:ALternative(?)]

Selects or queries the alternative scrambling code in the 3GPP-R5 downlink modulation analysis.

Syntax [:SENSe]:DLR5_3GPP:SCODE:ALternative { NUSed | PRIMary
 | LEFT | RIGHT }

[:SENSe]:DLR5_3GPP:SCODE:ALternative?

Arguments NUSed (default) uses the primary scrambling code only (without the left and the right alternative scrambling codes) to de-spread the input signal.

PRIMary uses the primary scrambling with the left and the right alternative scrambling codes to de-spread the input signal.

LEFT uses the left alternative scrambling code to de-spread the input signal.

RIGHT uses the right alternative scrambling code to de-spread the input signal.
Measurement Modes

Measurement Modes DEMDLR5_3G

Examples :SENSe:DLR5_3GPP:SCODE:ALternative RIGHT
 uses the right alternative scrambling code to de-spread the input signal.

[[:SENSe]:DLR5_3GPP:SCODE:NUMBER(?)]

Sets or queries the scrambling code in the 3GPP-R5 downlink analysis.

Syntax [:SENSe]:DLR5_3GPP:SCODE:NUMBER <value>
 [:SENSe]:DLR5_3GPP:SCODE:NUMBER?

Arguments <value>::=<NR1> specifies the scrambling code. Range: 0 to 24575.

Measurement Modes DEMDLR5_3G

Examples :SENSe:DLR5_3GPP:SCODE:NUMBER 3
 sets the scrambling code to 3.

Related Commands [:SENSe]:DLR5_3GPP:SCODE:SEARCh

[[:SENSe]:DLR5_3GPP:SCODE:SEARCh(?)]

Determines whether automatic detection of the scrambling code is on or off in the 3GPP-R5 downlink analysis.

Syntax [:SENSe]:DLR5_3GPP:SCODE:SEARCh { OFF | ON | 0 | 1 }
 [:SENSe]:DLR5_3GPP:SCODE:SEARCh?

Arguments OFF or 0 specifies that the scrambling code is not detected automatically.
 To set it, use the [:SENSe]:DLR5_3GPP:SCODE:NUMBER command above.

ON or 1 specifies that the scrambling code is detected automatically.

Measurement Modes DEMDLR5_3G

Examples :SENSe:DLR5_3GPP:SCODE:SEARCh ON
 specifies that the scrambling code is detected automatically.

Related Commands [:SENSe]:DLR5_3GPP:SCODE:NUMBER

[[:SENSe]:SADLR5_3GPP]:SAULR5_3GPP:ACLR Subgroup *3GPP-R5, Option 27 Only*

The [[:SENSe]:SADLR5_3GPP]:SAULR5_3GPP commands set up conditions for the ACLR (Adjacent Channel Leakage Power Ratio) measurement in the 3GPP-R5 downlink and uplink analyses.

Command Tree	Header	Parameter
	[[:SENSe]	
	:SADLR5_3GPP :SAULR5_3GPP	
	:ACLR	
	:FILTer	
	:COEFFicient	<numeric_value>
	:TYPE	RECTangle RNYQuist
	:LIMit	
	:ADJacent<x>	
	[[:STATe]	<boolean>
	:NCORrection	<boolean>
	:SWEep	<boolean>

Prerequisites for Use You must run the following two commands before using a command from this group:

1. Execute the :INSTRument command to set the measurement mode to SADLR5_3G or SAULR5_3G:

```
:INSTRument[:SElect] { "SADLR5_3G" | "SAULR5_3G" }
```

2. Execute the :CONFIgure command to start the measurement with the default settings:

```
:CONFIgure:SADLR5_3GPP|:SAULR5_3GPP:ACLR
```

[[:SENSE]:SADLR5_3GPP]:SAULR5_3GPP:ACLR:FILTer:COEFFicient(?)

Sets or queries the filter factor (a/BT) when you have selected RNYQuist (Root Nyquist filter) in the [[:SENSE]:SADLR5_3GPP]:SAULR5_3GPP:ACLR:FILTer:TYPE command for the 3GPP-R5 ACLR measurement.

Syntax [[:SENSE]:SADLR5_3GPP]:SAULR5_3GPP:ACLR:FILTer:COEFFicient
<value>
[[:SENSE]:SADLR5_3GPP]:SAULR5_3GPP:ACLR:FILTer:COEFFicient?

Arguments <value>::=<NRf> specifies the filter factor. Range: 0 to 1.

Measurement Modes SADLR5_3G, SAULR5_3G

Examples :SENSE:SADLR5_3GPP:ACLR:FILTer:COEFFicient 0.5
sets the filter factor to 0.5.

Related Commands [[:SENSE]:SADLR5_3GPP]:SAULR5_3GPP:ACLR:FILTer:TYPE

[[:SENSE]:SADLR5_3GPP]:SAULR5_3GPP:ACLR:FILTer:TYPE(?)

Selects or queries the filter for the 3GPP-R5 ACLR measurement.

Syntax [[:SENSE]:SADLR5_3GPP]:SAULR5_3GPP:ACLR:FILTer:TYPE
{ RECTangle | RNYQuist }
[[:SENSE]:SADLR5_3GPP]:SAULR5_3GPP:ACLR:FILTer:TYPE?

Arguments RECTangle selects the rectangular filter.
RNYQuist selects the Root Nyquist filter.

Measurement Modes SADLR5_3G, SAULR5_3G

Examples :SENSE:SADLR5_3GPP:ACLR:FILTer:TYPE RNYQuist
selects the Root Nyquist filter.

[[:SENSe]:SADLR5_3GPP]:SAULR5_3GPP:ACLR:LIMit:ADJacent<x>[:STATe](?)

Determines whether to enable or disable the adjacent limit testing for the ACLR measurement in the 3GPP-R5 analysis.

Syntax [:SENSe]:SADLR5_3GPP|:SAULR5_3GPP:ACLR:LIMit:ADJacent<x>
[:STATe] { ON | OFF | 1 | 0 }

[:SENSe]:SADLR5_3GPP|:SAULR5_3GPP:ACLR:LIMit:ADJacent<x>
[:STATe]?

Where ADJacent<x> ::= { ADJacent[1] | ADJacent2 | ADJacent3 | ADJacent4 }

ADJacent1: 1st lower adjacent channel

ADJacent2: 1st upper adjacent channel

ADJacent3: 2nd lower adjacent channel

ADJacent4: 2nd upper adjacent channel

Arguments ON or 1 enables the adjacent limit testing.

OFF or 0 disables the adjacent limit testing.

Measurement Modes SADLR5_3G, SAULR5_3G

Examples :SENSe:SADLR5_3GPP:ACLR:LIMit:ADJacent1 ON
enables the limit testing for the first adjacent channel in the ACLR measurement.

[[:SENSE]:SADLR5_3GPP]:SAULR5_3GPP:ACLR:NCORrection(?)

Determines whether to perform the noise correction, which subtract noise level from signal level to obtain the ACLR measurement results.

NOTE. *When you change amplitude and frequency settings, the noise correction setting returns to off. Turn it on again if necessary.*

Syntax [:SENSE]:SADLR5_3GPP|:SAULR5_3GPP:ACLR:NCORrection
 { ON | OFF | 1 | 0 }

[:SENSE]:SADLR5_3GPP|:SAULR5_3GPP:ACLR:NCORrection?

Arguments ON or 1 measures noise level first, and then, subtracts the noise level from the signal level to calculate ACLR measurement values.

OFF or 0 calculates ACLR measurement values directly from the input signal level (default).

Measurement Modes SADLR5_3G, SAULR5_3G

Examples :SENSE:SADLR5_3GPP:ACLR:NCORrection ON
 enables the noise correction.

[[:SENSe]:SADLR5_3GPP]:SAULR5_3GPP:ACLR:SWEep(?)

Selects or queries how to scan the 25 MHz span.

Syntax [:SENSe]:SADLR5_3GPP|:SAULR5_3GPP:ACLR:SWEep { ON | OFF | 1 | 0 }
[:SENSe]:SADLR5_3GPP|:SAULR5_3GPP:ACLR:SWEep?

Arguments ON or 1 acquires an input signal with five scans by the channel spacing of 5 MHz (default).
OFF or 0 acquires an input signal with a single scan in the 25 MHz span.

Measurement Modes SADLR5_3G, SAULR5_3G

Examples :SENSe:SADLR5_3GPP:ACLR:SWEep ON
selects the five scans by the channel spacing.

[[:SENSe]:SADLR5_3GPP]:SAULR5_3GPP:CFRequency Subgroup

3GPP-R5, Option 27 Only

The [[:SENSe]:SADLR5_3GPP]:SAULR5_3GPP:CHPower commands set up conditions for the carrier frequency measurement in the 3GPP-R5 downlink or uplink analysis.

Command Tree	Header	Parameter
	[[:SENSe]	
	:SADLR5_3GPP :SAULR5_3GPP	
	:CFRequency	
	:CRESolution	<numeric_value>

Prerequisites for Use

You must run the following two commands before using a command from this group:

1. Execute the :INSTrument command to set the measurement mode to SADLR5_3G or SAULR5_3G:

```
:INSTrument[:SElect] { "SADLR5_3G" | "SAULR5_3G" }
```

2. Execute the :CONFiGure command to start the measurement with the default settings:

```
:CONFiGure:SADLR5_3GPP|:SAULR5_3GPP:CFRequency
```

[[:SENSe]:SADLR5_3GPP]:SAULR5_3GPP:CFrequency:CRESolution(?)

Sets or queries the counter resolution for the carrier frequency measurement in the 3GPP-R5 analysis.

Syntax `[[:SENSe]:SADLR5_3GPP]:SAULR5_3GPP:CFrequency:CRESolution
<value>`

`[[:SENSe]:SADLR5_3GPP]:SAULR5_3GPP:CFrequency:CRESolution?`

Arguments `<value>::=<NRf>` specifies the counter resolution.
Setting value (Hz): 0.001, 0.01, 0.1, 1, 10, 100, 1k, 10k, 100k, or 1M

Measurement Modes All S/A modes

Examples `:SENSe:SADLR5_3GPP:CFrequency:CRESolution 1kHz`
sets the counter resolution to 1 kHz.

[:SENSE]:SADLR5_3GPP[:SAULR5_3GPP]:CHPower Subgroup

3GPP-R5, Option 27 Only

The [:SENSE]:SADLR5_3GPP[:SAULR5_3GPP]:CHPower commands set up conditions for the channel power measurement in the 3GPP-R5 downlink or uplink analysis.

Command Tree	Header	Parameter
	[:SENSE]	
	:SADLR5_3GPP[:SAULR5_3GPP]	
	:CHPower	
	:BANDwidth[:BWIDth]	
	:INTegration	<numeric_value>
	:FILTer	
	:COEFFicient	<numeric_value>
	:TYPE	RECTangle GAUSSian NYQuist RNYQuist
	:LIMit	
	[:STATe]	<boolean>

Prerequisites for Use

You must run the following two commands before using a command from this group:

1. Execute the :INSTrument command to set the measurement mode to SADLR5_3G or SAULR5_3G:

```
:INSTrument[:SElect] { "SADLR5_3G" | "SAULR5_3G" }
```

2. Execute the :CONFIgure command to start the measurement with the default settings:

```
:CONFIgure:SADLR5_3GPP[:SAULR5_3GPP]:CHPower
```

[[:SENSe]:SADLR5_3GPP]:SAULR5_3GPP:CHPower:BANDwidth]:BWIDth :INTEgration(?)

Sets or queries the channel bandwidth for the channel power measurement in the 3GPP-R5 analysis.

Syntax `[[:SENSe]:SADLR5_3GPP]:SAULR5_3GPP:CHPower:BANDwidth]:BWIDth :INTEgration <value>`

`[[:SENSe]:SADLR5_3GPP]:SAULR5_3GPP:CHPower:BANDwidth]:BWIDth :INTEgration?`

Arguments `<value>::=<NRf>` specifies the channel bandwidth.
Range: Span/20 to full span [Hz]

Measurement Modes SADLR5_3G, SAULR5_3G

Examples `:SENSe:SADLR5_3GPP:CHPower:BANDwidth:INTEgration 2.5MHz`
sets the channel bandwidth to 2.5 MHz for the channel power measurement.

[[:SENSe]:SADLR5_3GPP]:SAULR5_3GPP:CHPower:FILTer:COEFFicient(?)

Sets or queries the filter roll-off rate for the channel power measurement in the 3GPP-R5 downlink analysis when you have selected NYQuist or RNYQuist in the `[[:SENSe]:SADLR5_3GPP]:SAULR5_3GPP:CHPower FILTer:TYPE` command.

Syntax `[[:SENSe]:SADLR5_3GPP]:SAULR5_3GPP:CHPower:FILTer:COEFFicient <value>`

`[[:SENSe]:SADLR5_3GPP]:SAULR5_3GPP:CHPower:FILTer:COEFFicient?`

Arguments `<value>::=<NRf>` specifies the roll-off rate. Range: 0.0001 to 1 (default: 0.5)

Measurement Modes SADLR5_3G, SAULR5_3G

Examples `:SENSe:SADLR5_3GPP:CHPower:FILTer:COEFFicient 0.1`
sets the filter roll-off rate to 0.1 for the channel power measurement.

[[:SENSE]:SADLR5_3GPP]:SAULR5_3GPP:CHPower:FILTer:TYPE(?)

Selects or queries the filter for the channel power measurement in the 3GPP-R5 analysis.

Syntax [[:SENSE]:SADLR5_3GPP]:SAULR5_3GPP:CHPower:FILTer:TYPE
 { RECTangle | GAUSSian | NYQuist | RNYQuist }
 [[:SENSE]:SADLR5_3GPP]:SAULR5_3GPP:CHPower:FILTer:TYPE?

Arguments RECTangle selects the Rectangular filter.
 GAUSSian selects the Gaussian filter.
 NYQuist selects the Nyquist filter.
 RNYQuist selects the Root Nyquist filter.

Measurement Modes SADLR5_3G, SAULR5_3G

Examples :SENSE:SADLR5_3GPP:CHPower:FILTer:TYPE NYQuist
 selects the Nyquist filter for the channel power measurement.

[[:SENSE]:SADLR5_3GPP]:SAULR5_3GPP:CHPower:LIMit[:STATe](?)

Determines whether to enable or disable the limit testing for the channel power measurement in the 3GPP-R5 analysis.

Syntax [[:SENSE]:SADLR5_3GPP]:SAULR5_3GPP:CHPower:LIMit[:STATe]
 { ON | OFF | 1 | 0 }
 [[:SENSE]:SADLR5_3GPP]:SAULR5_3GPP:CHPower:LIMit[STATe]?

Arguments ON or 1 enables the limit testing.
 OFF or 0 disables the limit testing.

Measurement Modes SADLR5_3G, SAULR5_3G

Examples :SENSE:SADLR5_3GPP:CHPower:LIMit:STATe ON
 enables the limit testing for the channel power measurement.

[[:SENSe]:SADLR5_3GPP]:SAULR5_3GPP:EBWidth Subgroup

3GPP-R5, Option 27 Only

The [[:SENSe]:SADLR5_3GPP]:SAULR5_3GPP:EBWidth commands set up conditions for the EBW (Emission Bandwidth) measurement in the 3GPP-R5 downlink or uplink analysis.

Command Tree	Header	Parameter
	[[:SENSe]	
	:SADLR5_3GPP :SAULR5_3GPP	
	:EBWidth	
	:XDB	<numeric_value>

Prerequisites for Use

You must run the following two commands before using a command from this group:

1. Execute the :INSTRUMENT command to set the measurement mode to SADLR5_3G or SAULR5_3G:

```
:INSTRUMENT[:SElect] { "SADLR5_3G" | "SAULR5_3G" }
```

2. Execute the :CONFIGURE command to start the measurement with the default settings:

```
:CONFIGURE:SADLR5_3GPP|:SAULR5_3GPP:EBWidth
```

[[:SENSE]:SADLR5_3GPP]:SAULR5_3GPP:EBWidth:XDB(?)

Sets or queries the level relative to the maximum peak at which the EBW is measured in the 3GPP-R5 analysis.

Syntax [:SENSE]:SADLR5_3GPP]:SAULR5_3GPP:EBWidth:XDB <rel_amp>
 [:SENSE]:SADLR5_3GPP]:SAULR5_3GPP:EBWidth:XDB?

Arguments <rel_amp>: :=<NRf> is the level at which the EBW is measured.
 Specify the amplitude relative to the maximum peak.
 Range: -100 to -1 dB (default: -30 dB).

Measurement Modes SADLR5_3G, SAULR5_3G

Examples :SENSE:SADLR5_3GPP:EBWidth:XDB -20
 specifies that the EBW is measured at a level -20 dB lower than the maximum peak.

[[:SENSe]:SADLR5_3GPP:MCAClr Subgroup**3GPP-R5, Option 27 Only**

The [[:SENSe]:SADLR5_3GPP:MCAClr commands set up conditions for the multi-carrier ACLR (Adjacent Channel Leakage Power Ratio) measurement in the 3GPP-R5 downlink analysis.

Command Tree	Header	Parameter
	[[:SENSe]	
	:SADLR5_3GPP	
	:MCAClr	
	:CARRIER	
	[:THRESHOLD]	<numeric_value>
	:FILTER	
	:COEFFICIENT	<numeric_value>
	:TYPE	RECTANGLE RNYQUIST
	:LIMIT	
	:ADJACENT<x>	
	[:STATE]	<boolean>
	:NCORRECTION	<boolean>

Prerequisites for Use

You must run the following two commands before using a command from this group:

1. Execute the :INSTRUMENT command to set the measurement mode to SADLR5_3G:

```
:INSTRUMENT[:SELECT] "SADLR5_3G"
```

2. Execute the :CONFIGURE command to start the measurement with the default settings:

```
:CONFIGURE:SADLR5_3GPP:MCAClr
```

[[:SENSE]:SADLR5_3GPP:MCAClr:CARRIER[:THRESHOLD](?)

Sets or queries the threshold level to detect the carrier for the multi-carrier ACLR measurement.

Syntax [:SENSE]:SADLR5_3GPP:MCAClr:CARRIER[:THRESHOLD] <value>
 [:SENSE]:SADLR5_3GPP:MCAClr:CARRIER[:THRESHOLD]?

Arguments <value>::=<NRf> specifies the threshold level to detect the carrier.
 Range: -30 to -1 dBc relative to the main channel power.

Measurement Modes SADLR5_3G

Examples :SENSE:SADLR5_3GPP:ACLR:CARRIER:THRESHOLDt -5
 sets the threshold level to -5 dBc in the multi-carrier ACLR measurement.

[[:SENSe]:SADLR5_3GPP:MCAClr:FILTer:COEFFicient(?)]

Sets or queries the filter factor (α/BT) when you have selected RNYQuist (Root Nyquist filter) in the [[:SENSe]:SADLR5_3GPP:MCAClr:FILTer:TYPE] command for the multi-carrier ACLR measurement.

Syntax [[:SENSe]:SADLR5_3GPP:MCAClr:FILTer:COEFFicient
<value>
[[:SENSe]:SADLR5_3GPP:MCAClr:FILTer:COEFFicient?

Arguments <value>::=<NRF> specifies the filter factor. Range: 0 to 1.

Measurement Modes SADLR5_3G

Examples :SENSe:SADLR5_3GPP:ACLR:FILTer:COEFFicient 0.5
sets the filter factor to 0.5.

Related Commands [[:SENSe]:SADLR5_3GPP:MCAClr:FILTer:TYPE]

[[:SENSe]:SADLR5_3GPP:MCAClr:FILTer:TYPE(?)]

Selects or queries the filter for the multi-carrier ACLR measurement.

Syntax [[:SENSe]:SADLR5_3GPP:MCAClr:FILTer:TYPE { RECTangle | RNYQuist }
[[:SENSe]:SADLR5_3GPP:MCAClr:FILTer:TYPE?

Arguments RECTangle selects the rectangular filter.
RNYQuist selects the Root Nyquist filter.

Measurement Modes SADLR5_3G

Examples :SENSe:SADLR5_3GPP:ACLR:FILTer:TYPE RNYQuist
selects the Root Nyquist filter.

[[:SENSE]:SADLR5_3GPP:MCAClr:LIMit:ADJacent<x>[:STATE](?)

Determines whether to enable or disable the adjacent limit testing for the multi-carrier ACLR measurement.

Syntax [[:SENSE]:SADLR5_3GPP:MCAClr:LIMit:ADJacent<x>[:STATE]
{ ON | OFF | 1 | 0 }

[[:SENSE]:SADLR5_3GPP:MCAClr:LIMit:ADJacent<x>[:STATE]?

Where ADJacent<x> ::= { ADJacent[1] | ADJacent2 | ADJacent3 | ADJacent4 }

ADJacent1: 1st lower adjacent channel

ADJacent2: 1st upper adjacent channel

ADJacent3: 2nd lower adjacent channel

ADJacent4: 2nd upper adjacent channel

Arguments ON or 1 enables the adjacent limit testing.

OFF or 0 disables the adjacent limit testing.

Measurement Modes SADLR5_3G

Examples :SENSE:SADLR5_3GPP:ACLR:LIMit:ADJacent1 ON
enables the limit testing for the first adjacent channel.

[[:SENSe]:SADLR5_3GPP:MCAClr:NCORrection(?)]

Determines whether to perform the noise correction, which subtract noise level from signal level to obtain the multi-carrier ACLR measurement results.

NOTE. *When you change amplitude and frequency settings, the noise correction setting returns to off. Turn it on again if necessary.*

Syntax [:SENSe]:SADLR5_3GPP:MCAClr:NCORrection { ON | OFF | 1 | 0 }
[:SENSe]:SADLR5_3GPP:MCAClr:NCORrection?

Arguments ON or 1 measures noise level first, and then, subtracts the noise level from the signal level to calculate ACLR measurement values.

OFF or 0 calculates ACLR measurement values directly from the input signal level (default).

Measurement Modes SADLR5_3G

Examples :SENSe:SADLR5_3GPP:ACLR:NCORrection ON
enables the noise correction.

[:SENSE]:SADLR5_3GPP[:SAULR5_3GPP]:OBWidth Subgroup

3GPP-R5, Option 27 Only

The [:SENSE]:SADLR5_3GPP[:SAULR5_3GPP]:OBWidth commands set up conditions for the OBW (Occupied Bandwidth) measurement in the 3GPP-R5 downlink or uplink analysis.

Command Tree	Header	Parameter
	[:SENSE]	
	:SADLR5_3GPP[:SAULR5_3GPP]	
	:OBWidth	
	:LIMit	
	[:STATe]	<boolean>
	:PERCent	<numeric_value>

Prerequisites for Use

You must run the following two commands before using a command from this group:

1. Execute the :INSTrument command to set the measurement mode to SADLR5_3G or SAULR5_3G:

```
:INSTrument[:SElect] { "SADLR5_3G" | "SAULR5_3G" }
```

2. Execute the :CONFiGure command to start the measurement with the default settings:

```
:CONFiGure:SADLR5_3GPP[:SAULR5_3GPP]:OBWidth
```

[[:SENSe]:SADLR5_3GPP]:SAULR5_3GPP:OBWidth:LIMit[:STATe](?)

Determines whether to enable or disable the limit testing for the OBW measurement in the 3GPP-R5 analysis.

Syntax `[[:SENSe]:SADLR5_3GPP]:SAULR5_3GPP:OBWidth:LIMit[:STATe]
{ ON | OFF | 1 | 0 }
[:SENSe]:SADLR5_3GPP]:SAULR5_3GPP:OBWidth:LIMit[:STATe]?`

Arguments ON or 1 enables the limit testing.
OFF or 0 disables the limit testing.

Measurement Modes SADLR5_3G, SAULR5_3G

Examples `:SENSe:SADLR5_3GPP:OBWidth:LIMit:STATe ON`
enables the limit testing for the OBW measurement.

[[:SENSe]:SADLR5_3GPP]:SAULR5_3GPP:OBWidth:PERCent(?)

Sets or queries the occupied bandwidth for the OBW measurement in the 3GPP-R5 analysis.

Syntax `[[:SENSe]:SADLR5_3GPP]:SAULR5_3GPP:OBWidth:PERCent <value>
[:SENSe]:SADLR5_3GPP]:SAULR5_3GPP:OBWidth:PERCent?`

Arguments `<value>::=<NRf>` specifies the occupied bandwidth.
Range: 80 to 99.99% (default: 99%).

Measurement Modes SADLR5_3G, SAULR5_3G

Examples `:SENSe:SADLR5_3GPP:OBWidth:PERCent 95PCT`
sets the occupied bandwidth to 95% for the OBW measurement.

[:SENSE]:SADLR5_3GPP[:SAULR5_3GPP]:SEMask Subgroup

3GPP-R5, Option 27 Only

The [:SENSE]:SADLR5_3GPP[:SAULR5_3GPP]:SEMask commands set up conditions for the spectrum emission mask measurement in the 3GPP-R5 downlink or uplink analysis.

Command Tree	Header	Parameter
	[:SENSE]	
	:SADLR5_3GPP[:SAULR5_3GPP]	
	:SEMask	
	:BANDwidth BWIDth	
	:INTEgration	<numeric_value>
	:FILTer	
	:COEFFicient	<numeric_value>
	:TYPE	RECTangle GAUSSian NYQuist RNYQuist
	:LIMit	
	:ZONE<x>	
	[:STATE]	<boolean>
	:RCHannel	
	:LEVel	<numeric_value>
	:MODE	AUTO MANual

Prerequisites for Use

You must run the following two commands before using a command from this group:

1. Execute the :INSTRUMENT command to set the measurement mode to SADLR5_3G or SAULR5_3G:

```
:INSTRUMENT[:SElect] { "SADLR5_3G" | "SAULR5_3G" }
```

2. Execute the :CONFIGURE command to start the measurement with the default settings:

```
:CONFIGURE:SADLR5_3GPP[:SAULR5_3GPP]:SEMask
```

[[:SENSe]:SADLR5_3GPP]:SAULR5_3GPP:SEMask:BANDwidth]:BWIDth :INTEgration(?)

Sets or queries the channel bandwidth for the spectrum emission mask measurement in the 3GPP-R5 analysis.

Syntax `[[:SENSe]:SADLR5_3GPP]:SAULR5_3GPP:SEMask:BANDwidth]:BWIDth :INTEgration <value>`

`[[:SENSe]:SADLR5_3GPP]:SAULR5_3GPP:SEMask:BANDwidth]:BWIDth :INTEgration?`

Arguments `<value>::=<NRf>` specifies the channel bandwidth.
Range: Span/20 to full span [Hz]

Measurement Modes SADLR5_3G, SAULR5_3G

Examples `:SENSe:SADLR5_3GPP:SEMask:BANDwidth:INTEgration 2.5MHz`
sets the channel bandwidth to 2.5 MHz for the spectrum emission mask measurement.

[[:SENSE]:SADLR5_3GPP]:SAULR5_3GPP:SEMask:FILTer:COEFFicient(?)

Sets or queries the filter roll-off rate for the spectrum emission mask measurement in the 3GPP-R5 analysis when you have selected NYQuist or RNYQuist in the [:SENSE]:SADLR5_3GPP]:SAULR5_3GPP:SEMask:FILTer:TYPE command.

Syntax [:SENSE]:SADLR5_3GPP]:SAULR5_3GPP:SEMask:FILTer:COEFFicient
<value>

[:SENSE]:SADLR5_3GPP]:SAULR5_3GPP:SEMask:FILTer:COEFFicient?

Arguments <value>::=<NRf> specifies the roll-off rate.
Range: 0.0001 to 1 (default: 0.5)

Measurement Modes SADLR5_3G, SAULR5_3G

Examples :SENSE:SADLR5_3GPP:SEMask:FILTer:COEFFicient 0.1
sets the filter roll-off rate to 0.1 for the spectrum emission mask measurement.

Related Commands [:SENSE]:SADLR5_3GPP]:SAULR5_3GPP:SEMask:FILTer:TYPE

[[:SENSe]:SADLR5_3GPP]:SAULR5_3GPP:SEMask:FILTer:TYPE(?)

Selects or queries the filter for the spectrum emission mask measurement in the 3GPP-R5 analysis.

Syntax [:SENSe]:SADLR5_3GPP|:SAULR5_3GPP:SEMask:FILTer:TYPE
 { RECTangle | GAUSSian | NYQuist | RNYQuist }

[:SENSe]:SADLR5_3GPP|:SAULR5_3GPP:SEMask:FILTer:TYPE?

Arguments RECTangle selects the rectangular filter.

 GAUSSian selects the Gaussian filter.

 NYQuist selects the Nyquist filter.

 RNYQuist selects the Root Nyquist filter.

Measurement Modes SADLR5_3G, SAULR5_3G

Examples :SENSe:SADLR5_3GPP:SEMask:FILTer:TYPE NYQuist
 selects the Nyquist filter for the spectrum emission measurement.

[[:SENSE]:SADLR5_3GPP]:SAULR5_3GPP:SEMask:LIMit:ZONE<x>[:STATe](?)

Determines whether to enable or disable the zone limit testing for the spectrum emission mask measurement in the 3GPP-R5 downlink analysis.

Syntax [:SENSE]:SADLR5_3GPP]:SAULR5_3GPP:SEMask:LIMit:ZONE<x>[:STATe]
 { ON | OFF | 1 | 0 }
 [:SENSE]:SADLR5_3GPP]:SAULR5_3GPP:SEMask:LIMit:ZONE<x>[:STATe]?

Where

ZONE<x>::={ ZONE[1] | ZONE2 | ZONE3 | ZONE4 | ZONE5 }

Zone 1, 2, 3, 4, and 5 correspond to Zone A, B, C, D, and E in the limit editor, respectively.

Arguments ON or 1 enables the zone limit testing.
 OFF or 0 disables the zone limit testing.

Measurement Modes SADLR5_3G, SAULR5_3G

Examples :SENSE:SADLR5_3GPP:SEMask:LIMit:ZONE1:STATe ON
 enables the limit testing for Zone 1 in the spectrum emission mask measurement.

[[:SENSe]:SADLR5_3GPP]:SAULR5_3GPP:SEMask:RCHannel:LEVel(?)

Sets or queries the reference channel level to measure the spurious emission level in dBc when the you have selected MANual in the [:SENSe]:SADLR5_3GPP[:SAULR5_3GPP:SEMask:RCHannel:MODE command.

Syntax [:SENSe]:SADLR5_3GPP[:SAULR5_3GPP:SEMask:RCHannel:LEVel <value>
[:SENSe]:SADLR5_3GPP[:SAULR5_3GPP:SEMask:RCHannel:LEVel?

Arguments <value>::=<NRf> specifies the reference level. Range: -150 to 30 dBm

Measurement Modes SADLR5_3G, SAULR5_3G

Examples :SENSe:SADLR5_3GPP:SEMask:RCHannel:LEVel -10dBm
sets the reference channel level to -10 dBm for the spectrum emission mask measurement.

Related Commands [:SENSe]:SADLR5_3GPP[:SAULR5_3GPP:SEMask:RCHannel:MODE

[[:SENSE]:SADLR5_3GPP]:SAULR5_3GPP:SEMask:RCHannel:MODE(?)

Selects or queries the mode of the reference channel level to measure the spurious emission level in dBc.

Syntax [[:SENSE]:SADLR5_3GPP]:SAULR5_3GPP:SEMask:RCHannel:MODE
{ AUTO | MANua1 }

[[:SENSe]:SADLR5_3GPP]:SAULR5_3GPP:SEMask:RCHannel:MODE?

Arguments AUTO specifies that the reference level is measured from the input signal.

MANua1 specifies that the reference level is defined by the [[:SENSE]:SADLR5_3GPP]:SAULR5_3GPP:SEMask:RCHannel:LEVel command.

Measurement Modes SADLR5_3G, SAULR5_3G

Examples :SENSe:SADLR5_3GPP:SEMask:RCHannel:MODE AUTO
sets the mode of the reference channel level to AUTO for the spectrum emission mask measurement.

Related Commands [[:SENSE]:SADLR5_3GPP]:SAULR5_3GPP:SEMask:RCHannel:LEVel

[[:SENSe]:ULR5_3GPP Subgroup**3GPP-R5, Option 27 Only**

The [[:SENSe]:ULR5_3GPP commands set up conditions for the 3GPP-R5 uplink modulation analysis.

NOTE. To use a command from this group, you must have selected *DEMUL-R5_3G* (3GPP-R5 uplink modulation analysis mode) using the *:INSTrument [[:SElect]* command.

Command Tree	Header	Parameter
	[[:SENSe]	
	:ULR5_3GPP	
	:BLock	<numeric_value>
	:CARRier	
	:OFFSet	<frequency>
	:SEARCh	<boolean>
	:EVM	
	:IQOffset	INCLude EXCLude
	:FILTer	
	:ALPHa	<numeric_value>
	:MEASurement	OFF RR̄Cosine
	:REFerence	OFF RCosine GAUSSian
	[[:IMMediate]	
	:LENGth	<numeric_value>
	:MMOde	DPCH PR̄ACh PCPCh
	:OFFSet	<numeric_value>
	:SCODE	
	:NUMBer	<numeric_value>
	:TYPE	LONG SHORT
	:SFRame	
	:OFFSet	
	:DTIME	<numeric_value>
	[[:STSLot]	<numeric_value>
	:SEARCh	AUTO STSLot DTIME
	:THReshold	
	[[:BURSt]	<numeric_value>
	:UANResult	

[[:SENSE]:ULR5_3GPP:BLOCK(?)]

Sets or queries the number of the block to measure in the 3GPP-R5 uplink analysis.

Syntax [[:SENSE]:ULR5_3GPP:BLOCK <number>

[[:SENSE]:ULR5_3GPP:BLOCK?

Arguments <number>: :=<NRf> specifies the block number. Zero represents the latest block.
Range: -M to 0 (M: Number of acquired blocks)

Measurement Modes DEMULR5_3G

Examples :SENSE:ULR5_3GPP:BLOCK -5
sets the block number to -5.

[[:SENSe]:ULR5_3GPP:CARRier:OFFSet(?)]

Sets or queries the carrier frequency offset in the 3GPP-R5 uplink analysis.

Syntax [:SENSe]:ULR5_3GPP:CARRier:OFFSet <freq>
 [:SENSe]:ULR5_3GPP:CARRier:OFFSet?

Arguments <freq>: :=<Nrf> specifies the carrier frequency offset.
 Range: -Fs to Fs (Fs: Span)

Measurement Modes DEMULR5_3G

Examples :SENSe:ULR5_3GPP:CARRier:OFFSet 10MHz
 sets the carrier frequency offset to 10 MHz.

[[:SENSe]:ULR5_3GPP:CARRier:SEARch(?)]

Determines whether to detect the carrier automatically in the 3GPP-R5 uplink analysis.

Syntax [:SENSe]:ULR5_3GPP:CARRier:SEARch { OFF | ON | 0 | 1 }
 [:SENSe]:ULR5_3GPP:CARRier:SEARch?

Arguments OFF or 0 specifies that the carrier is not detected automatically. To set the carrier frequency offset, use the [:SENSe]:ULR5_3GPP:CARRier:OFFSet command.
 ON or 1 specifies that the carrier is detected automatically.

Measurement Modes DEMULR5_3G

Examples :SENSe:ULR5_3GPP:CARRier:SEARch ON
 specifies that the carrier is detected automatically.

Related Commands [:SENSe]:ULR5_3GPP:CARRier:OFFSet

[[:SENSe]:ULR5_3GPP:EVM:IQOffset(?)]

Determines whether to include the I/Q origin offset in the EVM (Error Vector Magnitude), Rho (waveform quality), and PCDE (Peak Code Domain Error) calculation.

Syntax [:SENSe]:ULR5_3GPP:EVM:IQoffset { INCLude | EXCLude }
 [:SENSe]:ULR5_3GPP:EVM:IQoffset?

Arguments INCLude includes the I/Q origin offset in the EVM, Rho, and PCDE calculation.
 EXCLude excludes the I/Q origin offset from the calculation.

Measurement Modes DEMULR5_3G

Examples :SENSe:ULR5_3GPP:IQoffset INCLude
 includes the I/Q origin offset in the calculation.

[[:SENSe]:ULR5_3GPP:FILTer:ALPHa(?)]

Sets or queries the filter factor (α/BT) for the measurement and the reference filters in the 3GPP-R5 uplink analysis.

Syntax [:SENSe]:ULR5_3GPP:FILTer:ALPHa <value>
 [:SENSe]:ULR5_3GPP:FILTer:ALPHa?

Arguments <value>::=<NRf> specifies the filter factor. Range: 0 to 1.

Measurement Modes DEMULR5_3G

Examples :SENSe:ULR5_3GPP:FILTer:ALPHa 0.5
 sets the filter factor to 0.5.

[[:SENSe]:ULR5_3GPP:FILTer:MEASurement(?)

Selects or queries the measurement filter in the 3GPP-R5 uplink analysis.

Syntax [:SENSe]:ULR5_3GPP:FILTer:MEASurement { OFF | RRCosine }
[:SENSe]:ULR5_3GPP:FILTer:MEASurement?

Arguments OFF specifies that no measurement filter is used.
RRCosine selects the Root Raised Cosine filter.

Measurement Modes DEMULR5_3G

Examples :SENSe:ULR5_3GPP:FILTer:MEASurement RRCosine
selects the Root Raised Cosine filter.

[[:SENSe]:ULR5_3GPP:FILTer:REFerence(?)

Selects or queries the reference filter in the 3GPP-R5 uplink analysis.

Syntax [:SENSe]:ULR5_3GPP:FILTer:REFerence { OFF | RCOSine | GAUSSian }
[:SENSe]:ULR5_3GPP:FILTer:REFerence?

Arguments OFF specifies that no reference filter is used.
RCOSine selects the Raised Cosine filter.
GAUSSian selects the Gaussian filter.

Measurement Modes DEMULR5_3G

Examples :SENSe:ULR5_3GPP:FILTer:REFerence RCOSine
selects the Raised Cosine filter.

[[:SENSE]:ULR5_3GPP[:IMMEDIATE]] (No Query Form)

Runs the 3GPP-R5 uplink analysis calculation for the acquired data.
To acquire data, use the :INITiate command.

Syntax [[:SENSE]:ULR5_3GPP[:IMMEDIATE]]

Arguments None

Measurement Modes DEMULR5_3G

Examples :SENSE:ULR5_3GPP:IMMEDIATE
runs the 3GPP-R5 uplink analysis calculation.

Related Commands :INITiate

[[:SENSE]:ULR5_3GPP:LENGTH(?)]

Defines or queries the range for the 3GPP-R5 uplink analysis.

Syntax [[:SENSE]:ULR5_3GPP:LENGTH <value>
[:SENSE]:ULR5_3GPP:LENGTH?

Arguments <value>::=<NRF> specifies the analysis range by the number of data points.
Range: 1 to 1024 × (block size).
To set the block size, use the [[:SENSE]:BSIZE] command.

Measurement Modes DEMULR5_3G

Examples :SENSE:ULR5_3GPP:LENGTH 1000
sets the analysis range to 1000 points.

Related Commands [[:SENSE]:BSIZE]

[[:SENSe]:ULR5_3GPP:MMOde(?)]

Selects or queries the mobile mode in the 3GPP-R5 uplink analysis.

Syntax [:SENSe]:ULR5_3GPP:MMOde { DPCh | PRACH | PCPCh }
 [:SENSe]:ULR5_3GPP:MMOde?

Arguments DPCh selects the DPDCH/DPCCH mode.
 PRACH selects the PRACH mode.
 PCPCh selects the PCPCH mode.

Measurement Modes DEMULR5_3G

Examples :SENSe:ULR5_3GPP:MMOde PRACH
 selects the PRACH mode.

[[:SENSe]:ULR5_3GPP:OFFSet(?)]

Sets or queries the measurement start position in the 3GPP-R5 uplink analysis.

Syntax [:SENSe]:ULR5_3GPP:OFFSet <value>
 [:SENSe]:ULR5_3GPP:OFFSet?

Arguments <value>: :=<NRf> specifies the measurement start position by the number of data points. Range: 0 to 1024 × (block size) - 1.
 To set the block size, use the [:SENSe]:BSIZE command.

Measurement Modes DEMULR5_3G

Examples :SENSe:ULR5_3GPP:OFFSet 100
 sets the measurement start position to point 100.

Related Commands [:SENSe]:BSIZE

[[:SENSe]:ULR5_3GPP:SCODE:NUMBER(?)]

Sets or queries the scrambling code in the 3GPP-R5 uplink analysis.

Syntax [:SENSe]:ULR5_3GPP:SCODE:NUMBER <value>
 [:SENSe]:ULR5_3GPP:SCODE:NUMBER?

Arguments <value>::=<NR1> specifies the scrambling code. Range: 0 to 16777215.

Measurement Modes DEMULR5_3G

Examples :SENSe:ULR5_3GPP:SCODE:NUMBER 3
 sets the scrambling code to 3.

[[:SENSe]:ULR5_3GPP:SCODE:TYPE(?)]

Selects or queries the scrambling code type.

Syntax [:SENSe]:ULR5_3GPP:SCODE:TYPE { LONG | SHORT }
 [:SENSe]:ULR5_3GPP:SCODE:TYPE?

Arguments LONG selects the long code.
 SHORT selects the short code.

Measurement Modes DEMULR5_3G

Examples :SENSe:ULR5_3GPP:SCODE:TYPE LONG
 selects the long code.

[[:SENSe]:ULR5_3GPP:SFRame:OFFSet:DTIME(?]

Sets or queries the downlink time offset when [[:SENSe]:ULR5_3GPP:SFRame:SEARCh is set to DTIME. The downlink time offset is the time offset between the start of HS-SCCH and the start of DPCH (refer to the *RSA3408A Option 27 User Manual*).

Syntax [[:SENSe]:ULR5_3GPP:SFRame:OFFSet:DTIME <value>
[[:SENSe]:ULR5_3GPP:SFRame:OFFSet:DTIME?

Arguments <value>::=<NRf> specifies the downlink time offset. Range: 0 to 149 symbols.

Measurement Modes DEMULR5_3G

Examples :SENSe:ULR5_3GPP:SFRame:OFFSet:DTIME 35
sets the downlink time offset to 35 symbols.

Related Commands [[:SENSe]:ULR5_3GPP:SFRame:SEARCh

[[:SENSe]:ULR5_3GPP:SFRame:OFFSet[:STSLot](?)

Sets or queries the subframe to time-slot offset when [[:SENSe]:ULR5_3GPP:SFRame:SEARCh is set to STSLot. The subframe to time-slot offset is the time offset between the start of the DPDCH time slot and the start of the HS-DPCCH subframe (refer to the *RSA3408A Option 27 User Manual*).

Syntax [[:SENSe]:ULR5_3GPP:SFRame:OFFSet[:STSLot] <value>
[[:SENSe]:ULR5_3GPP:SFRame:OFFSet[:STSLot]?

Arguments <value>::=<NRf> specifies the subframe to time-slot offset. Range: 0 to 9 symbols.

Measurement Modes DEMULR5_3G

Examples :SENSe:ULR5_3GPP:SFRame:OFFSet:STSLot 5
sets the subframe to time-slot offset to 5 symbols.

Related Commands [[:SENSe]:ULR5_3GPP:SFRame:SEARCh

[[:SENSE]:ULR5_3GPP:SFRame:SEARch(?)

Determines whether to detect the subframe offset automatically in the 3GPP-R5 uplink analysis.

Syntax [:SENSE]:ULR5_3GPP:SFRame:SEARch { AUTO | STSLot | DTIME }
 [:SENSE]:ULR5_3GPP:SFRame:SEARch?

Arguments AUTO specifies that the subframe offset is detected automatically (default).
 STSLot specifies the subframe to time-slot offset.
 Set the offset using the [:SENSE]:ULR5_3GPP:SFRame:OFFSet[:STSLot] command.
 DTIME specifies the downlink time offset.
 Set the offset using the [:SENSE]:ULR5_3GPP:SFRame:OFFSet:DTIME command.

Measurement Modes DEMULR5_3G

Examples :SENSE:ULR5_3GPP:SFRame:SEARch AUTO
 specifies that the subframe offset is detected automatically.

Related Commands [:SENSE]:ULR5_3GPP:SFRame:OFFSet:DTIME,
 [:SENSE]:ULR5_3GPP:SFRame:OFFSet[:STSLot]

[[:SENSe]:ULR5_3GPP:THReshold[:BURSt](?)

Sets or queries the threshold level to detect a burst. This command is valid when [:SENSe]:ULR5_3GPP:MMODE is set to PRACH.

Syntax [:SENSe]:ULR5_3GPP:THReshold[:BURSt] <value>

 [:SENSe]:ULR5_3GPP:THReshold[:BURSt]?

Arguments <value>: :=<NRf> specifies the threshold level to detect a burst.
Range: -100 to 10 dB.

Measurement Modes DEMULR5_3G

Examples :SENSe:ULR5_3GPP:THReshold:BURSt -20
 sets the threshold to -20 dB.

Related Commands [:SENSe]:ULR5_3GPP:MMODE

[[:SENSe]:ULR5_3GPP:UANResult (No Query Form)

Updates the ACK/NACK results by re-detecting ACK and NACK indications on the existing time slot data in the 3GPP-R5 uplink analysis.

Syntax [:SENSe]:ULR5_3GPP:UANResult

Arguments None

Measurement Modes DEMULR5_3G

Examples :SENSe:ULR5_3GPP:UANResult
 updates the ACK/NACK results.

[[:SENSE]:TD_SCDMA Subgroup***TD-SCDMA Analysis, Option 28 Only***

The [[:SENSE]:TD_SCDMA commands set up the conditions related to the TD-SCDMA analysis.

NOTE. To use a command from this group, you must have selected *DEMTD_SCDMA (TD-SCDMA analysis)* in the *:INSTRUMENT[:SELECT]* command.

Command Tree	Header	Parameter
	[[:SENSE]	
	:TD_SCDMA	
	:BLOCK	
	:FILTter	
	:MEASurement	OFF RCOSine RRCosine
	[:IMMediate]	
	:MEASurement	CHPower ACLR IM SEMask CDPower MACCuracy STABle TSSummary TOOMask OBWidth SFSummary OFF

[[:SENSe]:TD_SCDMA:BLOCK(?)]

Sets or queries the number of the block to measure in the TD-SCDMA analysis.

Syntax [:SENSe]:TD_SCDMA:BLOCK <numeric_value>
 [:SENSe]:TD_SCDMA:BLOCK?

Arguments <numeric_value>::=<NR1> specifies the block number. Zero represents the latest block.
 Range: -M to 0 (M: number of acquired blocks).

Measurement Modes DEMTD_SCDMA

Example :SENSe:TD_SCDMA:BLOCK -5
 sets the block number to -5 in the TD-SCDMA analysis.

[[:SENSe]:TD_SCDMA:FILTer:MEASurement(?)]

Sets or queries the measurement filter for the current measurement in the TD-SCDMA analysis.

NOTE. This command is not allowed if the current measurement is OBW.

Syntax [:SENSe]:TD_SCDMA:FILTer:MEASurement { OFF | RCOSine | RRCosine }
 [:SENSe]:TD_SCDMA:FILTer:MEASurement?

Arguments OFF selects no filter.
 RCOSine selects the Raised Cosine filter.
 RRCosine selects the Raised Cosine filter.

Measurement Modes DEMTD_SCDMA

Example :SENSe:TD_SCDMA:FILTer:MEASurement OFF
 sets the measurement filter to off for the current measurement.

[:SENSe]:TD_SCDMA[:IMMediate] (No Query Form)

Performs calculation for the acquired data in the TD-SCDMA analysis.

Syntax [:SENSe]:TD_SCDMA[:IMMediate]

Arguments None

Measurement Modes DEMTD_SCDMA

Example :SENSe:TD_SCDMA:IMMediate
performs calculation for the acquired data in the TD-SCDMA analysis.

[[:SENSe]:TD_SCDMA:MEASurement(?)]

Selects or queries the measurement item for the TD-SCDMA analysis.

Syntax `[[:SENSe]:TD_SCDMA:MEASurement { CHPower | ACLR | IM | SEMask
| CDPower | MACCuracy | STABle | TSSummary | TOOMask | OBWidth
| SFSummary | OFF }`

`[[:SENSe]:TD_SCDMA:MEASurement?`

Arguments The arguments and measurement items are listed below:

Argument	Measurement item
CHPower	Channel power measurement
ACLR	Adjacent Channel Leakage power Ratio (ACLR) measurement
IM	Intermodulation measurement
SEMask	Spectrum emission mask measurement
CDPower	Code domain power measurement
MACCuracy	Modulation accuracy measurement
STABle	Symbol table
TSSummary	Timeslot summary
TOOMask	Transmit on/off mask measurement
OBWidth	Occupied bandwidth measurement
SFSummary	Subframe summary
OFF	Measurement OFF

Measurement Modes DEMTD_SCDMA

Example `:SENSe:TD_SCDMA:MEASurement CDP`
selects the code domain power measurement for the TD-SCDMA analysis.

[[:SENSE]:TD_SCDMA:ACLR Subgroup***TD-SCDMA Analysis, Option 28 Only***

The [[:SENSE]:TD_SCDMA:ACLR commands set up the conditions related to the ACLR (Adjacent Channel Leakage power Ratio) measurement in the TD-SCDMA analysis.

NOTE. To use a command from this group, you must have selected *DEMTD_SCDMA* (TD-SCDMA analysis) in the *:INSTrument[:SElect]* command.

Command Tree	Header	Parameter
	[[:SENSE]	
	:TD_SCDMA	
	:ACLR	
	:DIRection?	
	:LIMit	
	:ADJacent[1] 2 3 4	
	[:STATe]	<boolean>

[[:SENSe]:TD_SCDMA:ACLR:DIRection? (Query Only)

Queries which limit table is used for the ACLR measurement in the TD-SCDMA analysis.

Syntax [:SENSe]:TD_SCDMA:ACLR:DIRection?

Returns UPLink Uplink
 DOWNlink Downlink

Measurement Modes DEMTD_SCDMA

[[:SENSe]:TD_SCDMA:ACLR:LIMit:ADJacent<x>[:STATe](?)

Sets or queries whether to enable or disable the adjacent limit testing for the ACLR measurement in the TD-SCDMA analysis.

Syntax [:SENSe]:TD_SCDMA:ACLR:LIMit:ADJacent<x>[:STATe] { ON | OFF
 | 1 | 0 }

[:SENSe]:TD_SCDMA:ACLR:LIMit:ADJacent[1]|2|3|4[:STATe]?

ADJacent<x> (x=1 to 4) is defined as follows:

ADJacent[1] is “1st Lower”.

ADJacent2 is “1st Upper”.

ADJacent3 is “2nd Lower”.

ADJacent4 is “2nd Upper”.

Arguments ON or 1 enables the adjacent limit testing.
 OFF or 0 disables the adjacent limit testing.

Measurement Modes DEMTD_SCDMA

Example :SENSe:TD_SCDMA:ACLR:LIMit:ADJacent 1
 enables the first lower adjacent limit testing for the ACLR measurement in the TD-SCDMA analysis.

[[:SENSE]:TD_SCDMA:ACQUISITION Subgroup***TD-SCDMA Analysis, Option 28 Only***

The [[:SENSE]:TD_SCDMA:ACQUISITION commands set up the conditions related to acquisition in the TD-SCDMA analysis.

NOTE. To use a command from this group, you must have selected *DEMTD_SCDMA (TD-SCDMA analysis)* in the *:INSTRUMENT[:SELECT]* command.

Command Tree	Header	Parameter
	[[:SENSE]	
	:TD_SCDMA	
	:ACQUISITION	
	:HISTORY	<numeric_value>
	:SECONDS	<numeric_value>
	:SFRAMES	<numeric_value>

[[:SENSe]:TD_SCDMA:ACQuisition:HISTory(?)]

Sets or queries the acquisition history. The acquisition can be viewed as it is selected, and can be reanalyzed after the selection.

Syntax [:SENSe]:TD_SCDMA:ACQuisition:HISTory <numeric_value>
 [:SENSe]:TD_SCDMA:ACQuisition:HISTory?

Arguments <numeric_value>::=<NR1> specifies the acquisition history.
 Range: No logical limitation to 0 (depends on Span and memory length).

Measurement Modes DEMTD_SCDMA

Example :SENSe:TD_SCDMA:ACQuisition:HISTory 0
 sets the acquisition history to 0 in the TD-SCDMA analysis.

[[:SENSe]:TD_SCDMA:ACQuisition:SEConds? (Query Only)]

Queries the acquisition length in seconds in the TD-SCDMA analysis.

Syntax [:SENSe]:TD_SCDMA:ACQuisition:SEConds?

Arguments None.

Measurement Modes DEMTD_SCDMA

Example :SENSe:TD_SCDMA:ACQuisition:SEConds?
 returns the acquisition length in seconds in the TD-SCDMA analysis.

[[:SENSe]:TD_SCDMA:ACQuisition:SFRames(?)

Sets or queries the acquisition length in subframes in the TD-SCDMA analysis.

Syntax [:SENSe]:TD_SCDMA:ACQuisition:SFRames <numeric_value>
 [:SENSe]:TD_SCDMA:ACQuisition:SFRames?

Arguments <numeric_value>::=<NR1> specifies the acquisition length in subframes
 Range: -4000 to no logical limitation (depends on Span and memory length).

Measurement Modes DEMTD_SCDMA

Example :SENSe:TD_SCDMA:ACQuisition:SFRames 10240
 sets the acquisition length in subframes to 10240 in the TD-SCDMA analysis.

[[:SENSe]:TD_SCDMA:ANALysis Subgroup***TD-SCDMA Analysis, Option 28 Only***

The [[:SENSe]:TD_SCDMA:ANALysis commands set up the analysis conditions in the TD-SCDMA analysis.

NOTE. To use a command from this group, you must have selected *DEMTD_SCDMA (TD-SCDMA analysis)* in the *:INSTRument[:SElect]* command.

Command Tree	Header	Parameter
	[[:SENSe]	
	:TD_SCDMA	
	:ANALysis	
	:CHANnel	
	:THReshold	<numeric_value>
	:INTerval	<numeric_value>
	:OFFSet	
	[:CHIPs]	<numeric_value>
	:DFRequency	<numeric_value>
	:IQ	<boolean>
	:REFerence	
	:SFRame	TRIGger DWPTs
	:TFPHase	MIDamble DWPTs
	:TIME	UTSPattern DWPTs
	:UTSPattern	<numeric_value>
	:TSlot	ALL CURRent
	:THReshold	<numeric_value>

[[:SENSE]:TD_SCDMA:ANALYSIS:CHANNEL:THRESHOLD(?)]

Sets or queries the threshold for the channel measurement in the TD-SCDMA analysis.

Syntax [[:SENSE]:TD_SCDMA:ANALYSIS:CHANNEL:THRESHOLD <numeric_value>
[[:SENSE]:TD_SCDMA:ANALYSIS:CHANNEL:THRESHOLD?

Arguments <numeric_value>::=<NR1> specifies the analysis channel threshold in dB.
Range: -100 dB to +50 dB

Measurement Modes DEMTD_SCDMA

Example :SENSE:TD_SCDMA:ANALYSIS:CHANNEL:THRESHOLD -30dB
sets the analysis channel threshold to -30 dB in the TD-SCDMA analysis.

[[:SENSE]:TD_SCDMA:ANALYSIS:INTERVAL(?)]

Sets or queries the analysis interval in chips in the TD-SCDMA analysis.

Syntax [[:SENSE]:TD_SCDMA:ANALYSIS:INTERVAL <numeric_value>
[[:SENSE]:TD_SCDMA:ANALYSIS:INTERVAL?

Arguments <numeric_value>::=<NR1> specifies the analysis interval in chips.
The range depends on the acquisition length setting.

Measurement Modes DEMTD_SCDMA

Example :SENSE:TD_SCDMA:ANALYSIS:INTERVAL 3072
sets the analysis interval in chips to 3072 in the TD-SCDMA analysis.

[[:SENSe]:TD_SCDMA:ANALysis:OFFSet[:CHIPs](?)

Sets or queries the analysis offset (the start point of the analysis range) in chips in the TD-SCDMA analysis.

Syntax [:SENSe]:TD_SCDMA:ANALysis:OFFSet[:CHIPs] <numeric_value>
[:SENSe]:TD_SCDMA:ANALysis:OFFSet[:CHIPs]?

Arguments <numeric_value>::=<NR1> specifies the analysis offset in chips.
Range: -65539999 to 65539999 chips.

Measurement Modes DEMTD_SCDMA

Example :SENSe:TD_SCDMA:ANALysis:OFFSet:CHIPs 512
sets the analysis offset in chips to 512 in the TD-SCDMA analysis.

[[:SENSe]:TD_SCDMA:ANALysis:OFFSet:DFRequency(?)

Sets or queries the demod frequency offset in the TD-SCDMA analysis.

Syntax [:SENSe]:TD_SCDMA:ANALysis:OFFSet:DFRequency <numeric_value>
[:SENSe]:TD_SCDMA:ANALysis:OFFSet:DFRequency?

Arguments <numeric_value>::=<NR1> specifies the analysis offset in MHz.
Range: -6.5 MHz to +6.5 MHz (depends on Span setting)

Measurement Modes DEMTD_SCDMA

Example :SENSe:TD_SCDMA:ANALysis:OFFSet:DFRequency 3.25
sets the analysis demod frequency offset to 3.25 MHz in the TD-SCDMA analysis.

[[:SENSE]:TD_SCDMA:ANALYSIS:OFFSET:IQ(?)]

Sets or queries the EVM measurement includes the I/Q offset in the TD-SCDMA analysis.

Syntax [[:SENSE]:TD_SCDMA:ANALYSIS:OFFSET:IQ <boolean>

[[:SENSE]:TD_SCDMA:ANALYSIS:OFFSET:IQ?

Arguments <boolean> ::=
 ON or 1 The EVM calculation includes I/Q offset
 OFF or 0 The EVM calculation does not include I/Q offset

Measurement Modes DEMTD_SCDMA

Example :SENSE:TD_SCDMA:ANALYSIS:OFFSET:IQ 1
 sets the analysis EVM measurement to include the I/Q offset in the TD-SCDMA analysis.

[[:SENSE]:TD_SCDMA:ANALYSIS:REFERENCE:SFRAME(?)]

Sets or queries the subframe reference in the TD-SCDMA analysis.

Syntax [[:SENSE]:TD_SCDMA:ANALYSIS:REFERENCE:SFRAME { TRIGGER | DWPTS }

[[:SENSE]:TD_SCDMA:ANALYSIS:REFERENCE:SFRAME?

Arguments TRIGGER specifies that the trigger point is used as the start of the subframe.
 DWPTS specifies that the downlink pilot is expected and is used to provide subframe timing.

Measurement Modes DEMTD_SCDMA

Example :SENSE:TD_SCDMA:REFERENCE:SFRAME TRIGGER
 sets the trigger point as the start of the subframe in the TD-SCDMA analysis.

[[:SENSe]:TD_SCDMA:ANALysis:REFerence:TFPHase(?)

Sets or queries the timeslot frequency and phase reference in the TD-SCDMA analysis.

Syntax [:SENSe]:TD_SCDMA:ANALysis:REFerence:TFPHase { MIDamble | DWPTs }
[:SENSe]:TD_SCDMA:ANALysis:REFerence:TFPHase?

Arguments MIDamble specifies that frequency/phase information is independently calculated for each timeslot.

DWPTs specifies that the freq and phase frequency is determined based upon the frequency/phase and position in the multiframe of the downlink pilot.

Measurement Modes DEMTD_SCDMA

Example :SENSe:TD_SCDMA:ANALysis:REFerence:TFPHase DWPTs
sets the frequency and phase frequency to be determined by the downlink pilot in the TD-SCDMA analysis.

[[:SENSe]:TD_SCDMA:ANALysis:REFerence:TIME(?)

Sets or queries the time reference for the Channel Power, ACLR, Intermodulation, and Occupied Bandwidth measurements in the TD-SCDMA Analysis.

Syntax [:SENSe]:TD_SCDMA:ANALysis:REFerence:TIME { UTSPattern | DWPTs }
[:SENSe]:TD_SCDMA:ANALysis:REFerence:TIME?

Arguments UTSPattern specifies that the subframe timing is determined by matching the detected timeslot pattern (specified by [:SENSe]:TD_SCDMA:ANALysis:REFerence:TIME:USTPattern command)

DWPTs specifies that the downlink pilot is expected and is used to determine subframe timing.

Measurement Modes DEMTD_SCDMA

Example :SENSe:TD_SCDMA:ANALysis:REFerence:TIME DWPTs
Sets the time reference to use the downlink pilot for subframe timing.

[[:SENSe]:TD_SCDMA:ANALysis:REFerence:TIME:UTSPattern(?)

Sets or queries the timeslot pattern to be expected in the signal when detecting the subframe timing for the ACLR, and the Intermodulation measurements for the TD-SCDMA Analysis.

NOTE. This command is only available when
[:SENSe]:TD_SCDMA:ANALysis:REFerence:TIME is set to UTSPattern.

Syntax [:SENSe]:TD_SCDMA:ANALysis:REFerence:TIME:UTSPattern
 <numeric_value>

 [:SENSe]:TD_SCDMA:ANALysis:REFerence:TIME:UTSPattern?

Arguments <numeric_value>
 Range: 1 to 123456 (any combination of digits 1 through 6)

Measurement Modes DEMTD_SCDMA

Example :SENSe:TD_SCDMA:ANALysis:REFerence:TIME:UTSPattern 14
 sets timeslots 1 and 4 to uplink timeslots.

[[:SENSe]:TD_SCDMA:ANALysis:TSLot(?)

Sets or queries the timeslot(s) to be analyzed in the TD-SCDMA analysis.

Syntax [:SENSe]:TD_SCDMA:ANALysis:TSLot { ALL | CURRent }
[:SENSe]:TD_SCDMA:ANALysis:TSLot?

Arguments ALL specifies that every timeslot which is active (has an active channel) is analyzed.

CURRent specifies that only the current timeslot shown in the Measurement Setup is analyzed.

Measurement Modes DEMTD_SCDMA

Example :SENSe:TD_SCDMA:ANALysis:TSLot ALL
analyzes all timeslots in the TD-SCDMA analysis.

[[:SENSe]:TD_SCDMA:ANALysis:TSLot:THReshold(?)

Sets or queries the level relative to the pilot which must be exceeded to identify a timeslot as active.

Syntax [:SENSe]:TD_SCDMA:ANALysis:TSLot:THReshold <numeric_value>
[:SENSe]:TD_SCDMA:ANALysis:TSLot:THReshold?

Arguments <numeric_value>::=<NR1> specifies the analysis timeslot threshold in dB.
Range: -50 dB to +50 dB

Measurement Modes DEMTD_SCDMA

Example :SENSe:TD_SCDMA:ANALysis:TSLot:THReshold -30dB
sets the analysis timeslot threshold to -30 dB in the TD-SCDMA analysis.

[[:SENSe]:TD_SCDMA:CHPower Subgroup***TD-SCDMA Analysis, Option 28 Only***

The [[:SENSe]:TD_SCDMA:CHPower commands set up the conditions related to the channel power measurement in the TD-SCDMA analysis.

NOTE. To use a command from this group, you must have selected *DEMTD_SCDMA* (TD-SCDMA analysis) in the *:INSTRument[:SElect]* command.

Command Tree	Header	Parameter
	[[:SENSe]	
	:TD_SCDMA	
	:CHPower	
	:BAWdwidth :BWiDth	
	:INTEgration	<numeric_value>
	:DIRection?	
	:LImit	
	[:STATe]	<boolean>

[[:SENSe]:TD_SCDMA:CHPower:BANDwidth]:BWIDth:INTEgration(?)

Sets or queries the channel bandwidth for the channel power measurement in the TD-SCDMA analysis.

Syntax [[:SENSe]:TD_SCDMA:CHPower:BANDwidth]:BWIDth:INTEgration
<numeric_value>

[[:SENSe]:TD_SCDMA:CHPower:BANDwidth]:BWIDth:INTEgration?

Arguments <numeric_value>::=<Nrf> specifies the channel bandwidth for the channel power measurement. Range: (Bin bandwidth) x 8 to full span [Hz].

Measurement Modes DEMTD_SCDMA

Example :SENSe:TD_SCDMA:CHPower:BANDwidth:INTEgration 2.5MHz
sets the channel bandwidth to 2.5 MHz for the channel power measurement in the TD-SCDMA analysis.

[[:SENSe]:TD_SCDMA:CHPower:DIRection? (Query Only)

Queries which limit table is used for the channel power measurement in the TD-SCDMA analysis.

Syntax [[:SENSe]:TD_SCDMA:CHPower:DIRection?

Returns UPLink Uplink
DOWNlink Downlink

Measurement Modes DEMTD_SCDMA

[[:SENSe]:TD_SCDMA:CHPower:LIMit[:STATe](?)

Sets or queries whether to enable or disable the limit testing for the channel power measurement in the TD-SCDMA analysis.

Syntax [:SENSe]:TD_SCDMA:CHPower:LIMit[:STATe] { ON | OFF | 1 | 0 }
[:SENSe]:TD_SCDMA:CHPower:LIMit[:STATe]?

Arguments ON or 1 enables the limit testing.
OFF or 0 disables the limit testing.

Measurement Modes DEMTD_SCDMA

Example :SENSe:TD_SCDMA:CHPower:LIMit:STATe ON
enables the limit testing for the channel power measurement in the TD-SCDMA analysis.

[[:SENSe]:TD_SCDMA:IM Subgroup

TD-SCDMA Analysis, Option 28 Only

The [[:SENSe]:TD_SCDMA:IM commands set up the conditions related to the intermodulation measurement in the TD-SCDMA analysis.

NOTE. To use a command from this group, you must have selected *DEMTD_SCDMA (TD-SCDMA analysis)* in the *:INSTRument[:SElect]* command.

Command Tree	Header	Parameter
	[[:SENSe]	
	:TD_SCDMA	
	:IM	
	:BAWdwidth :BWiDth	
	:INTEgration	<numeric_value>
	:DIRection?	
	:LIMit	
	:FORDER	
	[:STATe]	<boolean>
	:TORDER	
	[:STATe]	<boolean>
	:SCOFFset	<numeric_value>

[[:SENSE]:TD_SCDMA:IM:BANDwidth]:BWIDTH:INTEgration(?)

Sets or queries the channel bandwidth for the intermodulation measurement in the TD-SCDMA analysis.

Syntax [[:SENSE]:TD_SCDMA:IM:BANDwidth]:BWIDTH:INTEgration
<numeric_value>
[[:SENSE]:TD_SCDMA:IM:BANDwidth]:BWIDTH:INTEgration?

Arguments <numeric_value>::=<Nrf> specifies the bandwidth of the main channel for the intermodulation measurement.
Range: (Bin bandwidth) × 8 to full span [Hz].

Measurement Modes DEMTD_SCDMA

Example :SENSE:TD_SCDMA:IM:BANDwidth:INTEgration 2.5MHz
sets the channel bandwidth to 2.5 MHz for the intermodulation measurement in the TD-SCDMA analysis.

[[:SENSE]:TD_SCDMA:IM:DIRection? (Query Only)

Queries which limit table is used for the IM measurement in the TD-SCDMA analysis.

Syntax [[:SENSE]:TD_SCDMA:IM:DIRection?

Returns UPLink Uplink
DOWNlink Downlink

Measurement Modes DEMTD_SCDMA

[[:SENSe]:TD_SCDMA:IM:LIMit:FORDER[:STATE](?)

Sets or queries whether to enable or disable the fifth order limit testing for the intermodulation measurement in the TD-SCDMA analysis.

Syntax [:SENSe]:TD_SCDMA:IM:LIMit:FORDER[:STATE] { ON | OFF | 1 | 0 }
[:SENSe]:TD_SCDMA:IM:LIMit:FORDER[:STATE]?

Arguments ON or 1 enables the fifth order limit testing.
OFF or 0 disables the fifth order limit testing.

Measurement Modes DEMTD_SCDMA

Example :SENSe:TD_SCDMA:IM:LIMit:FORDER:STATE ON
enables the fifth order limit testing for the intermodulation measurement in the TD-SCDMA analysis.

[[:SENSe]:TD_SCDMA:IM:LIMit:TORDER[:STATE](?)

Sets or queries whether to enable or disable the third order limit testing for the intermodulation measurement in the TD-SCDMA analysis.

Syntax [:SENSe]:TD_SCDMA:IM:LIMit:TORDER[:STATE] { ON | OFF | 1 | 0 }
[:SENSe]:TD_SCDMA:IM:LIMit:TORDER[:STATE]?

Arguments ON or 1 enables the third order limit testing.
OFF or 0 disables the third order limit testing.

Measurement Modes DEMTD_SCDMA

Example :SENSe:TD_SCDMA:IM:LIMit:TORDER:STATE ON
enables the third order limit testing for the intermodulation measurement in the TD-SCDMA analysis.

[[:SENSe]:TD_SCDMA:IM:SCOFFset(?)

Sets or queries the second channel frequency for the intermodulation measurement in the TD-SCDMA analysis.

Syntax [:SENSe]:TD_SCDMA:IM:SCOFFset <numeric_value>
[:SENSe]:TD_SCDMA:IM:SCOFFset?

Arguments <numeric_value>::=<NRf> specifies the second channel frequency for the intermodulation.
Range: Span/20 to full span [Hz].

Measurement Modes DEMTD_SCDMA

Example :SENSe:TD_SCDMA:IM:SCOFFset 1.5MHz
sets the second channel frequency to 1.5 MHz for the intermodulation measurement in the TD-SCDMA analysis.

[[:SENSe]:TD_SCDMA:MACCuracy Subgroup

TD-SCDMA Analysis, Option 28 Only

The [[:SENSe]:TD_SCDMA:MACCuracy commands set up the conditions related to the modulation accuracy measurement in the TD-SCDMA analysis.

NOTE. To use a command from this group, you must have selected *DEMTD_SCDMA (TD-SCDMA analysis)* in the *:INSTRument[:SElect]* command.

Command Tree	Header	Parameter
	[[:SENSe]	
	:TD_SCDMA	
	:MACCuracy	
	:DIRection?	
	:LIMit	
	:EVM	
	:PEAK	
	[:STATE]	<boolean>
	:RMS	
	[:STATE]	<boolean>
	:PCDerror	
	[:STATE]	<boolean>
	:RHO	
	[:STATE]	<boolean>

[[:SENSE]:TD_SCDMA:MACCuracy:DIRrection? (Query Only)

Queries which limit table is used for the modulation accuracy measurement in the TD-SCDMA analysis.

Syntax [[:SENSE]:TD_SCDMA:MACCuracy:DIRrection?

Returns UPLink Uplink
DOWNlink Downlink

Measurement Modes DEMTD_SCDMA

[[:SENSE]:TD_SCDMA:MACCuracy:LIMit:EVM:PEAK[:STATe](?)

Sets or queries whether to enable or disable the PEAK EVM limit checking for the modulation accuracy measurement in the TD-SCDMA analysis.

Syntax [[:SENSE]:TD_SCDMA:MACCuracy:LIMit:EVM:PEAK[:STATe] { ON | OFF
| 1 | 0 }

[[:SENSE]:TD_SCDMA:MACCuracy:LIMit:EVM:PEAK[:STATe]?

Arguments ON or 1 enables the PEAK EVM limit testing.
OFF or 0 disables the PEAK EVM limit testing.

Measurement Modes DEMTD_SCDMA

Example :SENSE:TD_SCDMA:MACCuracy:LIMit:EVM:PEAK:STATe ON
enables the PEAK EVM limit testing for the modulation accuracy measurement in TD-SCDMA analysis.

[[:SENSe]:TD_SCDMA:MACCuracy:LIMit:EVM:RMS[:STATe]](?)

Sets or queries whether to enable or disable the RMS EVM limit testing for the modulation accuracy measurement in the TD-SCDMA analysis.

Syntax [:SENSe]:TD_SCDMA:MACCuracy:LIMit:EVM:RMS[:STATe] { ON | OFF
 | 1 | 0 }
[:SENSe]:TD_SCDMA:MACCuracy:LIMit:EVM:RMS[:STATe]?

Arguments ON or 1 enables the RMS EVM limit testing.
 OFF or 0 disables the RMS EVM limit testing.

Measurement Modes DEMTD_SCDMA

Example :SENSe:TD_SCDMA:MACCuracy:LIMit:EVM:RMS:STATe ON
 enables the RMS EVM limit testing for the modulation accuracy measurement in
 the TD-SCDMA analysis.

[[:SENSE]:TD_SCDMA:MACCuracy:LIMit:PCDerror[:STATe](?)

Sets or queries whether to enable or disable the peak code domain error limit testing for the code domain power measurement in the TD-SCDMA analysis.

NOTE. This command is for the peak code domain error limit testing and does not affect modulation accuracy (MACCuracy) measurements.

Syntax [:SENSE]:TD_SCDMA:MACCuracy:LIMit:PCDerror[:STATe] { ON | OFF
 | 1 | 0 }

[:SENSE]:TD_SCDMA:MACCuracy:LIMit:PCDerror[:STATe]?

Arguments ON or 1 enables the peak code domain error limit testing.
 OFF or 0 disables the peak code domain error limit testing.

Measurement Modes DEMTD_SCDMA

Example :SENSE:TD_SCDMA:MACCuracy:LIMit:PCDerror:STATe ON
 enables the peak code domain error limit testing for the code domain power
 measurement in the TD-SCDMA analysis.

[[:SENSe]:TD_SCDMA:MACCuracy:LIMit:RHO[:STATe](?)

Sets or queries whether to enable or disable the Rho limit testing for the modulation accuracy measurement in the TD-SCDMA analysis.

Syntax [:SENSe]:TD_SCDMA:MACCuracy:LIMit:RHO[:STATe] { ON | OFF
 | 1 | 0 }

[:SENSe]:TD_SCDMA:MACCuracy:LIMit:RHO[:STATe]?

Arguments ON or 1 enables the Rho limit testing.
 OFF or 0 disables the Rho limit testing.

Measurement Modes DEMTD_SCDMA

Example :SENSe:TD_SCDMA:MACCuracy:LIMit:RHO:STATe ON
 enables the Rho limit testing for the modulation accuracy measurement in the TD-SCDMA analysis.

[[:SENSe]:TD_SCDMA:MODulation Subgroup***TD-SCDMA Analysis, Option 28 Only***

The [[:SENSe]:TD_SCDMA:MODulation commands set up the modulation conditions related to the TD-SCDMA analysis.

NOTE. To use a command from this group, you must have selected *DEMTD_SCDMA (TD-SCDMA analysis)* in the *:INSTrument[:SElect]* command.

Command Tree	Header	Parameter
	[[:SENSe]	
	:TD_SCDMA	
	:MODulation	
	:CONTrol	AUTO MANual
	:K	
	:NZERO	<numeric_value>
	:ZERo	<numeric_value>
	:SCODE	<numeric_value>
	:SPOint	<numeric_value>
	:SYNC	
	:UPLink	<numeric_value>
	:DOWNlink	<numeric_value>

[[:SENSe]:TD_SCDMA:MODulation:CONTRol(?)

Sets or queries the method used to set other modulation parameters in the TD-SCDMA analysis.

Syntax [:SENSe]:TD_SCDMA:MODulation:CONTRol { AUTO | MANual }

[:SENSe]:TD_SCDMA:MODulation:CONTRol?

Arguments AUTO specifies that SyncDL, SyncUL, Scrambling Code, and K(TS0), K(TS1-TS6) are set by the analysis.

MANual specifies that all settings can be individually set without regard to other settings.

NOTE. *When switching from MANual to COUPled, all settings retain their current values.*

Measurement Modes DEMTD_SCDMA

Example :SENSe:TD_SCDMA:MODulation:CONTRol MANual
sets the modulation parameter controls to manual mode.

[[:SENSE]:TD_SCDMA:MODulation:K:NZERO(?)]

Sets or queries the the K value for all timeslots other than 0 in the TD-SCDMA analysis.

Syntax [[:SENSE]:TD_SCDMA:MODulation:K:NZERO <numeric_value>

[[:SENSE]:TD_SCDMA:MODulation:K:NZERO?

Arguments <numeric_value>::=<NR1> specifies the K value for timeslots other than 0.
Range: 2 to 16.

Measurement Modes DEMTD_SCDMA

Example :SENSE:TD_SCDMA:MODulation:K:NZERO 2
sets the K value to 2 for all timeslots except timeslot 0 in the TD-SCDMA analysis.

[[:SENSE]:TD_SCDMA:MODulation:K:ZERO(?)]

Sets or queries the the K value for timeslot 0 in the TD-SCDMA analysis.

Syntax [[:SENSE]:TD_SCDMA:MODulation:K:ZERO <numeric_value>

[[:SENSE]:TD_SCDMA:MODulation:K:ZERO?

Arguments <numeric_value>::=<NR1> specifies the K value for timeslot 0
Range: 2 to 16.

Measurement Modes DEMTD_SCDMA

Example :SENSE:TD_SCDMA:MODulation:K:ZERO 2
sets the K value to 2 for timeslot 0 in the TD-SCDMA analysis.

[[:SENSe]:TD_SCDMA:MODulation:SCODE(?)

Sets or queries the the scrambling code value in the TD-SCDMA analysis.

Syntax [:SENSe]:TD_SCDMA:MODulation:SCODE <numeric_value>
 [:SENSe]:TD_SCDMA:MODulation:SCODE?

Arguments <numeric_value>::=<NR1> specifies the scrambling code
 Range: 0 to 127.

Measurement Modes DEMTD_SCDMA

Example :SENSe:TD_SCDMA:MODulation:SCODE 0
 sets the scrambling code to 0 in the TD-SCDMA analysis.

[[:SENSe]:TD_SCDMA:MODulation:SPOint(?)

Sets or queries the switching point between the Uplink and Downlink timeslots in the TD-SCDMA analysis.

NOTE. This command also affects Channel Power, ACLR, Intermodulation, and Occupied Bandwidth measurements.

Syntax [:SENSe]:TD_SCDMA:MODulation:SPOint <numeric_value>
 [:SENSe]:TD_SCDMA:MODulation:SPOint?

Arguments <numeric_value>::=<NR1> specifies the switching point
 Range: 0 to 6.

Measurement Modes DEMTD_SCDMA

Example :SENSe:TD_SCDMA:MODulation:SPOint 3
 sets the timeslot switching point to timeslot 3 in the TD-SCDMA analysis.

[[:SENSe]:TD_SCDMA:MODulation:SYNC:DOWNlink(?)]

Sets or queries the the sync uplink value in the TD-SCDMA analysis.

Syntax [[:SENSe]:TD_SCDMA:MODulation:SYNC:DOWNlink <numeric_value>
[[:SENSe]:TD_SCDMA:MODulation:SYNC:DOWNlink?

Arguments <numeric_value>::=<NR1> specifies the sync downlink.
Range: 0 to 31.

Measurement Modes DEMTD_SCDMA

Example :SENSe:TD_SCDMA:MODulation:SYNC:DOWNlink 0
sets the code number of the downlink pilot pattern to 0 in the TD-SCDMA analysis.

[[:SENSe]:TD_SCDMA:MODulation:SYNC:UPLink(?)]

Sets or queries the the sync uplink value in the TD-SCDMA analysis.

Syntax [[:SENSe]:TD_SCDMA:MODulation:SYNC:UPLink <numeric_value>
[[:SENSe]:TD_SCDMA:MODulation:SYNC:UPLink?

Arguments <numeric_value>::=<NR1> specifies the sync uplink.
Range: 0 to 255.

Measurement Modes DEMTD_SCDMA

Example :SENSe:TD_SCDMA:MODulation:SYNC:UPLink 0
sets the code number of the uplink pilot pattern to 0 in the TD-SCDMA analysis.

[[:SENSe]:TD_SCDMA:OBWidth Subgroup

TD-SCDMA Analysis, Option 28 Only

The [[:SENSe]:TD_SCDMA:OBWidth commands set up the conditions related to the occupied bandwidth (OBW) measurement in the TD-SCDMA analysis.

NOTE. To use a command from this group, you must have selected *DEMTD_SCDMA* (TD-SCDMA analysis) in the *:INSTRument[:SElect]* command.

Command Tree	Header	Parameter
	[[:SENSe]	
	:TD_SCDMA	
	:OBWidth	
	:DIRection?	
	:LIMit	
	[:STATe]	<boolean>
	:PERCent	<numeric_value>

[[:SENSE]:TD_SCDMA:OBWidth:DIRection? (Query Only)

Queries which limit table is used for the occupied bandwidth measurement in the TD-SCDMA analysis.

Syntax [[:SENSE]:TD_SCDMA:OBWidth:DIRection?

Returns UPLink Uplink
DOWNlink Downlink

Measurement Modes DEMTD_SCDMA

[[:SENSE]:TD_SCDMA:OBWidth:LIMit[:STATe](?)

Sets or queries whether to enable or disable the limit testing for the OBW measurement in the TD-SCDMA analysis.

Syntax [[:SENSE]:TD_SCDMA:OBWidth:LIMit[:STATe] { ON | OFF | 1 | 0 }
[[:SENSE]:TD_SCDMA:OBWidth:LIMit[:STATe]?

Arguments ON or 1 enables the limit testing.
 OFF or 0 disables the limit testing.

Measurement Modes DEMTD_SCDMA

Example :SENSE:TD_SCDMA:OBWidth:LIMit:STATe ON
 sets the limit testing to ON for the OBW measurement in the TD-SCDMA analysis.

[[:SENSe]:TD_SCDMA:OBWidth:PERCent(?)]

Sets or queries the occupied bandwidth for the OBW measurement in the TD-SCDMA analysis.

Syntax [:SENSe]:TD_SCDMA:OBWidth:PERCent <numeric_value>

[:SENSe]:TD_SCDMA:OBWidth:PERCent?

Arguments <numeric_value>::=<Nrf> specifies the occupied bandwidth.
Range: 80% to 99.99% (default: 99%).

Measurement Modes DEMTD_SCDMA

Example :SENSe:TD_SCDMA:OBWidth:PERCent 95PCT
sets the occupied bandwidth to 95% for the OBW measurement in the TD-SCDMA analysis.

[[:SENSE]:TD_SCDMA:SElect Subgroup***TD-SCDMA Analysis, Option 28 Only***

The [[:SENSE]:TD_SCDMA:SElect commands set up the select conditions related to the TD-SCDMA analysis.

NOTE. To use a command from this group, you must have selected *DEMTD_SCDMA (TD-SCDMA analysis)* in the *:INSTRument[:SElect]* command.

Command Tree	Header	Parameter
	[[:SENSE]	
	:TD_SCDMA	
	:SElect	
	:CODE	<numeric_value>
	:SFRame	<numeric_value>
	:TSLot	TS0N DWPTs UPPTs TS1N TS2N TS3N TS4N TS5N TS6N

[[:SENSe]:TD_SCDMA:SElect:CODE(?)]

Sets or queries the selected code in the TD-SCDMA analysis.

NOTE. *When the displayed results can be separated by code, this control selects the results to be displayed by code. At other times, this control is not available.*

Syntax [:SENSe]:TD_SCDMA:SElect:CODE <numeric_value>

[:SENSe]:TD_SCDMA:SElect:CODE?

Arguments <numeric_value>::=<NR1> specifies the code.
Range: 0 to 15

Measurement Modes DEMTD_SCDMA

Example :SENSe:TD_SCDMA:SElect:CODE 2
sets the analysis to code 2 in the TD-SCDMA analysis.

[[:SENSe]:TD_SCDMA:SElect:SFRame(?)

Sets or queries the selected subframe in the TD-SCDMA analysis.

NOTE. This command is only available when results are available for multiple subframes.

Syntax [:SENSe]:TD_SCDMA:SElect:SFRame <numeric_value>

[:SENSe]:TD_SCDMA:SElect:SFRame?

Arguments <numeric_value>::=<NR1> specifies the subframe.
Range: 0 to -2047. This is limited by the number of frames which have been analyzed.

Measurement Modes DEMTD_SCDMA

Example :SENSe:TD_SCDMA:SElect:SFRame -30
sets the selected subframe to -30, or the 30th subframe before the most recent one in the TD-SCDMA analysis.

[**:SENSe**]:TD_SCDMA:SElect:TSLot(?)

Sets or queries the selected timeslot in the TD-SCDMA analysis.

NOTE. This command is only available when results are available for multiple subframes.

Syntax [**:SENSe**]:TD_SCDMA:SElect:TSLot { TS0N | DWPTs | UPPTs | TS1N
| TS2N | TS3N | TS4N | TS5N | TS6N }

[**:SENSe**]:TD_SCDMA:SElect:TSLot?

Arguments The arguments and measurement items are listed below:

Argument	Description
TS0N	Timeslot 0
DWPTs	Downlink pilot
UPPTs	Uplink pilot
TS1N	Timeslot 1
TS2N	Timeslot 2
TS3N	Timeslot 3
TS4N	Timeslot 4
TS5N	Timeslot 5
TS6N	Timeslot 6

Measurement Modes DEMTD_SCDMA

Example :SENSe:TD_SCDMA:SElect:TSLot TS4N
sets the analysis to timeslot 4 in the TD-SCDMA analysis.

[[:SENSe]:TD_SCDMA:SEMAsk Subgroup***TD-SCDMA Analysis, Option 28 Only***

The [[:SENSe]:TD_SCDMA:SEMAsk commands set up the conditions related to the spectrum emission mask measurement in the TD-SCDMA analysis.

NOTE. To use a command from this group, you must have selected *DEMTD_SCDMA* (TD-SCDMA analysis) in the *:INSTRument[:SElect]* command.

Command Tree	Header	Parameter
	[[:SENSe]	
	:TD_SCDMA	
	:SEMAsk	
	:BAWdwidth :BWIth	
	:INtegration	<numeric_value>
	:DIRection?	UPLink DOWNlink
	:LImit	
	:ISpurious	
	:ZONE[1] 2 3 4 5	
	[:STATe]	<boolean>
	:OFCHanne1	
	:ZONE[1] 2 3 4 5	
	[:STATe]	<boolean>
	:MEASurement	OFCHanne1 ISpurious
	:RCHanne1	
	:LEVel	<numeric_value>
	:MODE	AUTO MANUal

[[:SENSe]:TD_SCDMA:SEMask:BANDwidth]:BWIDth:INTEgration(?)

Sets or queries the channel bandwidth for the spectrum emission mask measurement in the TD-SCDMA analysis.

NOTE. This command is only available when
[:SENSe]:TD_SCDMA:SEMask:RCHannel:MODE command selects MANual.

Syntax [:SENSe]:TD_SCDMA:SEMask:BANDwidth|:BWIDth:INTEgration
<numeric_value>

[:SENSe]:TD_SCDMA:SEMask:BANDwidth|:BWIDth:INTEgration?

Arguments <numeric_value>::=<NRf> specifies the channel bandwidth.
Range: (Bin bandwidth) x 8 to full span [Hz].

Measurement Modes DEMTD_SCDMA

Example :SENSe:TD_SCDMA:SEMask:BANDwidth:INTEgration 2.5MHz
sets the channel bandwidth to 2.5 MHz for the spectrum emission mask measurement in the TD-SCDMA analysis.

[[:SENSe]:TD_SCDMA:SEMask:DIRection(?)

Sets or queries which limit table is used for the spectrum emission mask measurement in the TD-SCDMA analysis.

Syntax [:SENSe]:TD_SCDMA:SEMask:DIRection { UPLink | DOWNlink }

[:SENSe]:TD_SCDMA:SEMask:DIRection?

Returns UPLink Uplink
DOWNlink Downlink

Measurement Modes DEMTD_SCDMA

Example :SENSe:TD_SCDMA:SEMask:DIRection UPLink
sets the spectrum emission mask measurement to use the uplink limits table in the TD-SCDMA analysis.

[[:SENSe]:TD_SCDMA:SEMask:LIMit:ISpurious:ZONE<x>[:STATe](?)

Sets or queries whether to enable or disable the offset from the inband spurious zone limit testing for the spectrum emission mask measurement in the TD-SCDMA analysis.

Syntax [:SENSe]:TD_SCDMA:SEMask:LIMit:ISpurious:ZONE<x>[:STATe]
{ ON | OFF | 1 | 0 }

[:SENSe]:TD_SCDMA:SEMask:LIMit:ISpurious:ZONE<x>[:STATe]?

Where x=1 to 5. Zones 1, 2, 3, 4, and 5 correspond to Zones A, B, C, D, and E in the limit editor, respectively.

Arguments ON or 1 enables the offset from the inband spurious zone limit testing.
OFF or 0 disables the offset from the inband spurious zone limit testing.

Measurement Modes DEMTD_SCDMA

Example :SENSe:TD_SCDMA:SEMask:LIMit:ISpurious:ZONE1:STATe ON
enables the offset from the inband spurious limit testing of zone 1 for the spectrum emission mask measurement in the TD-SCDMA analysis.

[[:SENSe]:TD_SCDMA:SEMask:LIMit:OFCHannel:ZONE<x>[:STATe](?)

Sets or queries whether to enable or disable the offset from the channel zone limit testing for the spectrum emission mask measurement in the TD-SCDMA analysis.

Syntax [:SENSe]:TD_SCDMA:SEMask:LIMit:OFCHannel:ZONE<x>[:STATe]
 { ON | OFF | 1 | 0 }

[:SENSe]:TD_SCDMA:SEMask:LIMit:OFCHannel:ZONE<x>[:STATe]?

Where x=1 to 5. Zones 1, 2, 3, 4, and 5 correspond to Zones A, B, C, D, and E in the limit editor, respectively.

Arguments ON or 1 enables the offset from the channel zone limit testing.

OFF or 0 disables the offset from the channel zone limit testing.

Measurement Modes DEMTD_SCDMA

Example :SENSe:TD_SCDMA:SEMask:LIMit:OFCHannel:ZONE 1:STATe ON
enables the offset from the channel limit testing of zone 1 for the spectrum emission mask measurement in the TD-SCDMA analysis.

[[:SENSE]:TD_SCDMA:SEMask:MEASurement(?)]

Sets or queries the limit table type used for limit testing for the spectrum emission mask measurement in the TD-SCDMA analysis.

Syntax [:SENSE]:TD_SCDMA:SEMask:MEASurement { OFCHannel | ISpurious }
[:SENSE]:TD_SCDMA:SEMask:MEASurement?

Arguments OFCHannel selects the Offset From Channel type where frequency zones are specified by the difference from the center frequency.

ISpurious selects the Inband Spurious type in which frequency zones are specified by the absolute values.

Measurement Modes DEMTD_SCDMA

Example :SENSE:TD_SCDMA:SEMask:MEASurement ISpurious
selects the Inband Spurious limit table for the spectrum emission mask measurement in the TD-SCDMA analysis.

[[:SENSe]:TD_SCDMA:SEMask:RCHannel:LEVel(?]

Sets or queries the reference channel level to measure the spurious emission level in dBc.

NOTE. This command is only available when
[:SENSe]:TD_SCDMA:SEMask:RCHannel:MODE command selects MANual.

Syntax [:SENSe]:TD_SCDMA:SEMask:RCHannel:LEVel <numeric_value>
 [:SENSe]:TD_SCDMA:SEMask:RCHannel:LEVel?

Arguments <numeric_value>::=<NRf> specifies the reference level.
 Range: -100 to 30 dBm.

Measurement Modes DEMTD_SCDMA

Example :SENSe:TD_SCDMA:SEMask:RCHannel:LEVel -10dBm
 sets the reference channel level to -10 dBm for the spectrum emission mask
 measurement in the TD-SCDMA analysis.

Related Commands [:SENSe]:TD_SCDMA:SEMask:RCHannel:MODE

[[:SENSE]:TD_SCDMA:SEMask:RCHannel:MODE(?)]

Selects or queries the selecting mode of the reference channel level to measure the spurious emission level in dBc in the TD-SCDMA analysis.

Syntax [[:SENSE]:TD_SCDMA:SEMask:RCHannel:MODE { AUTO | MANua1 }

[[:SENSE]:TD_SCDMA:SEMask:RCHannel:MODE?

Arguments AUTO specifies that the reference channel level is measured from the input signal for the specified channel bandwidth

MANua1 specifies that the reference channel level has to be defined by the command [[:SENSE]:TD_SCDMA:SEMask:RCHannel:LEVel.

Measurement Modes DEMTD_SCDMA

Example :SENSE:TD_SCDMA:SEMask:RCHannel:MODE AUTO
sets the reference channel level to be measured from the input signal for the spectrum emission mask measurement in the TD-SCDMA analysis.

Related Commands [[:SENSE]:TD_SCDMA:SEMask:RCHannel:LEVel

[[:SENSe]:TD_SCDMA:SPECTrum Subgroup

TD-SCDMA Analysis, Option 28 Only

The [[:SENSe]:TD_SCDMA:SPECTrum commands set up the spectrum conditions related to the TD-SCDMA analysis.

NOTE. *To use a command from this group, you must have selected DEMTD_SCDMA (TD-SCDMA analysis) in the :INSTRument[:SElect] command.*

Command Tree	Header	Parameter
	[[:SENSe]	
	:TD_SCDMA	
	:SPECTrum	
	:OFFSet	<numeric_value>
	:TINTerval?	

[[:SENSE]:TD_SCDMA:SPECTrum:OFFSet(?)]

Sets or queries the spectrum offset within the time window in the TD-SCDMA analysis.

Syntax [[:SENSE]:TD_SCDMA:SPECTrum:OFFSet <numeric_value>

[[:SENSE]:TD_SCDMA:SPECTrum:OFFSet?

Arguments <numeric_value>::=<NRF> specifies the spectrum offset within the time windows.
Range: 0 ms to 26.56 ms.

Measurement Modes DEMTD_SCDMA

Example :SENSE:TD_SCDMA:SPECTrum:OFFSet 10ms
sets the spectrum offset within the time window to 10 ms in the TD-SCDMA analysis.

[[:SENSE]:TD_SCDMA:SPECTrum:TINTerval? (Query Only)]

Queries the length of the time-domain information used to construct the spectrum trace in the TD-SCDMA analysis.

Syntax [[:SENSE]:TD_SCDMA:SPECTrum:TINTerval?

Arguments None

Measurement Modes DEMTD_SCDMA

Example :SENSE:TD_SCDMA:SPECTrum:TINTerval?
returns the length of the time-domain information in the TD-SCDMA analysis.

[[:SENSe]:TD_SCDMA:STABLE Subgroup

TD-SCDMA Analysis, Option 28 Only

The [[:SENSe]:TD_SCDMA:STABLE commands set up the conditions related to the Symbol Table in the TD_SCDMA analysis.

NOTE. To use a command from this group, you must have selected *DEMTD_SCDMA (TD-SCDMA analysis)* in the *:INSTRument[:SElect]* command.

Command Tree

Header

Parameter

[[:SENSe]

 :TD_SCDMA

 :STABLE

 :TPCSs

 :COUNT

 ONE | D16Sfactor

 :SElect

 <boolean>

[[:SENSE]:TD_SCDMA:STABLE:TPCSs:COUNT(?)]

Sets or queries the TPC and SS symbol count in the TD-SCDMA analysis.

Syntax [[:SENSE]:TD_SCDMA:STABLE:TPCSs:COUNT { ONE | D16Sfactor }
[[:SENSE]:TD_SCDMA:STABLE:TPCSs:COUNT?

Arguments ONE specifies that the symbols in the Data2 burst will be decided as if only one TPC and SS symbol are present.
D16Sfactor specifies that the number of symbols for each TPC and SS segment is assumed to be 16 divided by the spreading factor.

Measurement Modes DEMTD_SCDMA

Example :SENSE:TD_SCDMA:STABLE:TPCSs:COUNT ONE
sets the symbol count in the data2 burst to one for both TPC and SS symbols in TD-SCDMA analysis.

[[:SENSE]:TD_SCDMA:STABLE:TPCSs:SELEct(?)]

Sets or queries whether to enable or disable the TPC and SS in the Data2 burst in the TD-SCDMA analysis.

Syntax [[:SENSE]:TD_SCDMA:STABLE:TPCSs:SELEct { ON | OFF | 1 | 0 }
[[:SENSE]:TD_SCDMA:STABLE:TPCSs:SELEct?

Arguments ON or 1 enables that both TPC and SS symbols can be found in the Data2 burst.
OFF or 0 disables that all Data2 burst symbols are data only.

Measurement Modes DEMTD_SCDMA

Example :SENSE:TD_SCDMA:STABLE:TPCSs:SELEct ON
enables that both TPC and SS symbols can be found in the Data2 burst in TD-SCDMA analysis.

[[:SENSe]:TD_SCDMA:TOOMask Subgroup

TD-SCDMA Analysis, Option 28 Only

The [[:SENSe]:TD_SCDMA:TOOMask commands set up the conditions related to the transmit on/off mask measurement in the TD-SCDMA analysis.

NOTE. To use a command from this group, you must have selected *DEMTD_SCDMA (TD-SCDMA analysis)* in the *:INSTRument[:SElect]* command.

Command Tree	Header	Parameter
	[[:SENSe]	
	:TD_SCDMA	
	:TOOMask	
	:DIRection	
	:LIMit	
	:LEVel	
	:MRAMP	
	[:STATE]	<boolean>
	:ONOFF	
	[:STATE]	<boolean>

[[:SENSE]:TD_SCDMA:TOOMask:DIRrection? (Query Only)

Queries which limit table is used for the transmit on/off mask measurement in the TD-SCDMA analysis.

Syntax [[:SENSE]:TD_SCDMA:TOOMask:DIRrection?

Returns UPLink Uplink
DOWNlink Downlink

Measurement Modes DEMTD_SCDMA

[[:SENSE]:TD_SCDMA:TOOMask:LIMit:LEVel:MRAMp[:STATe](?)

Sets or queries the enable or disable transmit on/off mid-ramp level limit checking for the transmit on/off mask measurement in the TD-SCDMA analysis.

NOTE. When [[:SENSE]:TD_SCDMA:TOOMask:DIRrection? returns *ULPlink*, the limit is the transmit *ON* mid-ramp level. When the query returns *DOWNlink*, the limit is the transmit *OFF* mid-ramp level.

Syntax [[:SENSE]:TD_SCDMA:TOOMask:LIMit:LEVel:MRAMp[:STATe] { ON | OFF
| 1 | 0 }

[[:SENSE]:TD_SCDMA:TOOMask:LIMit:LEVel:MRAMp[:STATe]?

Arguments ON or 1 enables the transmit on/off mid-ramp level mask limit testing.
OFF or 0 disables the transmit on/off mid-ramp level mask limit testing.

Measurement Modes DEMTD_SCDMA

Example :SENSE:TD_SCDMA:TOOMask:LIMit:LEVel:MRAMp:STATe ON
enables the mid-ramp level limit testing of the transmit on/off mask measurement in the TD-SCDMA analysis.

[[:SENSe]:TD_SCDMA:TOOMask:LIMit:LEVel:ONOFF[:STATe](?)

Sets or queries the enable or disable transmit on/off limit checking for the transmit on/off mask measurement in the TD-SCDMA analysis.

Syntax [:SENSe]:TD_SCDMA:TOOMask:LIMit:LEVel:ONOFF[:STATe] { ON | OFF
 | 1 | 0 }
[:SENSe]:TD_SCDMA:TOOMask:LIMit:LEVel:ONOFF[:STATe]?

Arguments ON or 1 enables the transmit on/off mask limit testing.
 OFF or 0 disables the transmit on/off mask limit testing.

Measurement Modes DEMTD_SCDMA

Example :SENSe:TD_SCDMA:TOOMask:LIMit:LEVel:ONOFF:STATe ON
 enables the limit testing of the transmit on/off mask measurement in the
 TD-SCDMA analysis.

[[:SENSE]:M2WLAN Subgroup**WLAN, Option 29 Only**

The [[:SENSE]:M2WLAN commands set up the conditions for the IEEE802.11n MIMO (2x2) analysis.

NOTE. To use a command from this group, you must have selected *DEMM2WLAN (IEEE802.11 MIMO (2x2) analysis)* in the *:INSTrument[:SElect]* command.

Command Tree	Header	Parameter
	[[:SENSE]	
	:M2WLAN	
	:ACQuisition	
	:HISTory	<numeric_value>
	:SEConds	<numeric_value>
	:ANALysis	
	:LENGth	<numeric_value>
	:OFFSet	<numeric_value>
	:SYNC	LTFIELD PILOT
	:BLOCk	<numeric_value>
	[[:IMMediate]	
	:MEASurement	ATFunction PTFunction DPRofile EVTime PVTime CONSTE EVSC PVSC SCConste FERRor STABLE OFF
	:PACKet	
	[:NUMBER]	<numeric_value>
	:SPECtrum	
	:OFFSet	<numeric_value>
	:SSEGment	
	[:NUMBER]	<numeric_value>
	:SUBCarrier	
	[:NUMBER]	<numeric_value>
	:SElect	DATA PILOT BOTH SSUBcarrier
	:TXAntenna	
	:SElect	ONE TWO

[[:SENSe]:M2WLAN:ACQuisition:HISTory(?)]

Sets or queries an acquisition history (serial number assigned to each acquisition) to display or analyze the data.

Arguments [[:SENSe]:M2WLAN:ACQuisition:HISTory <value>

[[:SENSe]:M2WLAN:ACQuisition:HISTory?

Arguments <value>::=<NRf> sets the acquisition history. The maximum value is zero that represents the latest. The minimum value depends on span and memory length. You can see it with [[:SENSe]:M2WLAN:ACQuisition:HISTory? MINimum.

Measurement Modes DEMM2WLAN

Examples :SENSe:M2WLAN:ACQuisition:HISTory -100
sets the acquisition history to -100.

[[:SENSe]:M2WLAN:ACQuisition:SEConds(?)]

Sets or queries the acquisition length in seconds.

Syntax [[:SENSe]:M2WLAN:ACQuisition:SEConds <value>

[[:SENSe]:M2WLAN:ACQuisition:SEConds?

Arguments <value>::=<NRf> sets the acquisition length. The minimum value is 20 μ s. The maximum value depends on span and memory length. You can see it with [[:SENSe]:M2WLAN:ACQuisition:SEConds? MAXimum.

Measurement Modes DEMM2WLAN

Examples :SENSe:M2WLAN:ACQuisition:SEConds 2.5m
sets the acquisition length to 2.5 ms.

[[:SENSE]:M2WLAN:ANALYSIS:LENGTH(?)]

Sets or queries the time length for the 802.11n MIMO (2x2) analysis.

Syntax [:SENSE]:M2WLAN:ANALYSIS:LENGTH <value>
 [:SENSE]:M2WLAN:ANALYSIS:LENGTH?

Arguments <value>::=<NRf> specifies the analysis range in seconds. Range: 0 to 100 ms.

Measurement Modes DEMM2WLAN

Examples :SENSE:M2WLAN:ANALYSIS:LENGTH 50m
 sets the analysis range to 50 ms.

[[:SENSE]:M2WLAN:ANALYSIS:OFFSET(?)]

Sets or queries the measurement start position in the 802.11n MIMO (2x2) analysis.

Syntax [:SENSE]:M2WLAN:ANALYSIS:OFFSET <value>
 [:SENSE]:M2WLAN:ANALYSIS:OFFSET?

Arguments <value>::=<NRf> specifies the analysis offset in seconds. Range: 0 to 100 ms.

Measurement Modes DEMM2WLAN

Examples :SENSE:M2WLAN:ANALYSIS:OFFSET 50m
 sets the analysis range to 50 ms.

[[:SENSe]:M2WLAN:ANALysis:SYNC(?)]

Selects or queries the synchronization method for the analysis.

Syntax [:SENSe]:M2WLAN:ANALysis:SYNC { LTFiEld | PILOt }
 [:SENSe]:M2WLAN:ANALysis:SYNC?

Arguments LTFiEld specifies to synchronize with the long training field.
 PILOt specifies to synchronize with the pilot signals.

Measurement Modes DEMM2WLAN

Examples :SENSe:M2WLAN:ANALysis:SYNC LTFiEld
 specifies to synchronize with the long training field.

[[:SENSe]:M2WLAN:BLOCK(?)]

Sets or queries the number of the block to measure in the 802.11n MIMO (2x2) analysis.

Syntax [:SENSe]:M2WLAN:BLOCK <vaLue>
 [:SENSe]:M2WLAN:BLOCK?

Arguments <vaLue>::=<NR1> specifies the block number. Zero represents the latest block.
 Range: -M to 0 (M: the number of acquired blocks)

Measurement Modes DEMM2WLAN

Examples :SENSe:M2WLAN:BLOCK -5
 sets the block number to -5.

[[:SENSE]:M2WLAN[:IMMEDIATE] (No Query Form)

Runs the demodulation calculation for the acquired data in the 802.11n MIMO (2x2) analysis. To select the measurement item, use the [:SENSE]:M2WLAN:MEASUREMENT command. To acquire data, use the :INITIATE command.

Syntax [:SENSE]:M2WLAN[:IMMEDIATE]

Arguments None

Measurement Modes DEMM2WLAN

Examples :SENSE:M2WLAN:IMMEDIATE
runs the demodulation calculation for the acquired data.

Related Commands :INITIATE, [:SENSE]:M2WLAN:MEASUREMENT

[:SENSe]:M2WLAN:MEASurement(?)

Selects or queries the measurement item in the 802.11n MIMO (2x2) analysis. To acquire data, use the :INITiate command. To start the analysis, use the [:SENSe]:M2WLAN[:IMMEDIATE] command.

Syntax [:SENSe]:M2WLAN:MEASurement { ATFunction | PTFunction | DPRofile | EVTime | PVTime | CONSTe | EVSC | PVSC | SCConste | FERRor | STABle | OFF }

[:SENSe]:M2WLAN:MEASurement?

Arguments Table 2-120 shows the measurement selections.

Table 2-119: Measurements, 802.11n MIMO

Argument	Measurement item
ATFunction	Transfer Function (Amplitude)
PTFunction	Transfer Function (Phase)
DPRofile	Delay Profile
EVTime	EVM versus Time
PVTime	Power versus Time
CONSte	Constellation
EVSC	EVM versus Subcarrier
PVSC	Power versus Subcarrier
SCConste	Subcarrier constellation
FERRor	Frequency error
STABle	Symbol table
OFF	Measurement off

Measurement Modes DEMM2WLAN

Examples :SENSe:M2WLAN:MEASurement ATFunction
selects the Transfer Function (Amplitude).

Related Commands :INITiate, [:SENSe]:M2WLAN[:IMMEDIATE]

[:SENSE] :M2WLAN :PACKet [:NUMBer] (?)

Sets or queries the packet number to measure.

Syntax [:SENSE] :M2WLAN :PACKet [:NUMBer] <number>
[:SENSE] :M2WLAN :PACKet [:NUMBer] ?

Arguments <number> : = <NR1> specifies the packet number.
Range: -[(the number of packets in the analysis range) - 1] to 0.
Zero (0) represents the latest packet.

Measurement Modes DEMM2WLAN

Examples :SENSE:M2WLAN:PACKet:NUMBer -10
sets the packet number to -10.

[:SENSE] :M2WLAN :SPECTrum :OFFSet (?)

Sets or queries the spectrum offset within the acquisition length.
Spectrum Offset is the beginning of Spectrum Length to display spectrum in the subview.

Syntax [:SENSE] :M2WLAN :SPECTrum :OFFSet <value>
[:SENSE] :M2WLAN :SPECTrum :OFFSet ?

Arguments <value> : = <NRf> specifies the spectrum offset in seconds. Range: 0 to 100 ms.

Measurement Modes DEMM2WLAN

Examples :SENSE:M2WLAN:SPECTrum:OFFSet 20m
sets the spectrum offset to 20 ms.

[[:SENSe]:M2WLAN:SSEGment[:NUMBer](?)

Sets or queries the symbol (segment) number. This command is valid when [:SENSe]:M2WLAN:MEASurement is set to ATFunction, PTFunction, DPRofile, EVSC, PVSC, SCConste, or STABLE.

Syntax [:SENSe]:M2WLAN:SSEGment[:NUMBer] <number>
 [:SENSe]:M2WLAN:SSEGment[:NUMBer]?

Arguments <number>::=<NR1> specifies the symbol number.
 Range: -[(the number of symbols in the analysis range) - 1] to 0.
 Zero (0) represents the latest symbol.

Measurement Modes DEMM2WLAN

Examples :SENSe:M2WLAN:SSEGment:NUMBer -32
 sets the symbol number to -32.

Related Commands [:SENSe]:M2WLAN:MEASurement

[[:SENSe]:M2WLAN:SUBCarrier[:NUMBer](?)

Sets or queries the subcarrier number when [:SENSe]:M2WLAN:SUBCarrier:SElect is set to SSUBcarrier.

Syntax [:SENSe]:M2WLAN:SUBCarrier[:NUMBer] <number>
 [:SENSe]:M2WLAN:SUBCarrier[:NUMBer]?

Arguments <number>::=<NR1> specifies the subcarrier number.
 Range: -64 to +63.

Measurement Modes DEMM2WLAN

Examples :SENSe:M2WLAN:SUBCarrier:NUMBer 10
 sets the subcarrier number to 10.

Related Commands [:SENSe]:M2WLAN:SUBCarrier:SElect

[[:SENSE]:M2WLAN:SUBCarrier:SElect(?)

Selects or queries the subcarrier(s) to display.

Syntax [:SENSE]:M2WLAN:SUBCarrier:SElect
 { DATA | PILOt | BOTH | SSUBcarrier }

[:SENSE]:M2WLAN:SUBCarrier:SElect?

Arguments DATA selects the data only.

 PILOt selects the pilot only.

 BOTH selects the data and the pilot (default).

 SSUBcarrier selects the subcarrier specified using the [:SENSE]:M2WLAN
 :SUBCarrier[:NUMBER] command (Single Subcarrier). This selection is effective
 in the EVM versus Time, Power versus Time, and Constellation measurements.

Measurement Modes DEMM2WLAN

Examples :SENSE:M2WLAN:SUBCarrier:SElect DATA
 selects the data only.

Related Commands [:SENSE]:M2WLAN:SUBCarrier[:NUMBER],
 :DISPlay:M2WLAN:DDEMod:SVIew:FORMat

[[:SENSe]:M2WLAN:TXAntenna:SElect (?)]

Selects or queries the transmission antenna to display the measurement results.

Syntax [:SENSe]:M2WLAN:TXAntenna:SElect { ONE | TWO }
[:SENSe]:M2WLAN:TXAntenna:SElect?

Arguments ONE displays the measurement results for signals transmitted by Tx Antenna 1.
TWO displays the measurement results for signals transmitted by Tx Antenna 2.

Measurement Modes DEMM2WLAN

Examples :SENSe:M2WLAN:TXAntenna:SElect ONE
selects Tx Antenna 1 to display the measurement results.

[[:SENSE]:SWLAN Subgroup**WLAN, Option 29 Only**

The [[:SENSE]:SWLAN commands set up the conditions related to the IEEE802.11n (nx1) analysis.

NOTE. To use a command from this group, you must have selected DEMSWLAN (IEEE802.11n (nx1) analysis) in the :INSTRUMENT[:SELEct] command.

Command Tree	Header	Parameter
	[[:SENSE]	
	:SWLAN	
	:ACQuisition	
	:HISTory	<numeric_value>
	:SEConds	<numeric_value>
	:ANALysis	
	:EQUalization	
	[:STATe]	<boolean>
	:LENGth	<numeric_value>
	:OFFSet	<numeric_value>
	:SFORmat	ONE TW0
	:SYNC	LTField PILot
	:BLOCK	<numeric_value>
	[:IMMediate]	
	:MEASurement	ATFunction PTFunction DPRofile EVTime PVTime CONSTe EVSC PVSC SCConste FERRor OFLatness OLINearity STABLE SMASK OFF
	:PACKet	
	[:NUMBer]	<numeric_value>
	:SMASK	
	[:SELEct]	EFFective INValid
	:SPECTrum	
	:OFFSet	<numeric_value>
	:SSEGment	
	[:NUMBer]	<numeric_value>
	:SUBCarrier	
	[:NUMBer]	<numeric_value>
	:SELEct	DATA PILot BOTH SSUBcarrier
	:TXAntenna	
	:SELEct	ONE TWO

[[:SENSe]:SWLAN:ACQuisition:HISTory(?)]

Sets or queries an acquisition history (serial number assigned to each acquisition) to display or analyze the data.

Arguments [[:SENSe]:SWLAN:ACQuisition:HISTory <value>
[[:SENSe]:SWLAN:ACQuisition:HISTory?

Arguments <value>::=<NRf> sets the acquisition history. The maximum value is zero that represents the latest. The minimum value depends on span and memory length. You can see it with [[:SENSe]:SWLAN:ACQuisition:HISTory? MINimum.

Measurement Modes DEMSWLAN

Examples :SENSe:SWLAN:ACQuisition:HISTory -100
sets the acquisition history to -100.

[[:SENSe]:SWLAN:ACQuisition:SEConds(?)]

Sets or queries the acquisition length in seconds.

Syntax [[:SENSe]:SWLAN:ACQuisition:SEConds <value>
[[:SENSe]:SWLAN:ACQuisition:SEConds?

Arguments <value>::=<NRf> sets the acquisition length. The minimum value is 20 μ s. The maximum value depends on span and memory length. You can see it with [[:SENSe]:SWLAN:ACQuisition:SEConds? MAXimum.

Measurement Modes DEMSWLAN

Examples :SENSe:SWLAN:ACQuisition:SEConds 2.5m
sets the acquisition length to 2.5 ms.

[[:SENSE]:SWLAN:ANALYSIS:EQUALIZATION[:STATE](?)

Determines whether to enable or disable the data correction for the long training symbol during the 802.11n (nx1) analysis.

Syntax [:SENSE]:SWLAN:ANALYSIS:EQUALIZATION[:STATE] { 0 | 1 | OFF | ON }
 [:SENSE]:SWLAN:ANALYSIS:EQUALIZATION[:STATE]?

Arguments OFF or 0 disables the correction function.
 ON or 1 enables the correction function.

Measurement Modes DEMSWLAN

Examples :SENSE:SWLAN:ANALYSIS:EQUALIZATION:STATE ON
 enables the correction function.

[[:SENSE]:SWLAN:ANALYSIS:LENGTH(?)

Sets or queries the time length for the 802.11n (nx1) analysis.

Syntax [:SENSE]:SWLAN:ANALYSIS:LENGTH <value>
 [:SENSE]:SWLAN:ANALYSIS:LENGTH?

Arguments <value>::=<NRf> specifies the analysis range in seconds. Range: 0 to 100 ms.

Measurement Modes DEMSWLAN

Examples :SENSE:SWLAN:ANALYSIS:LENGTH 50m
 sets the analysis range to 50 ms.

[[:SENSe]:SWLAN:ANALysis:OFFSet(?)

Sets or queries the measurement start position in the 802.11n (nx1) analysis.

Syntax [:SENSe]:SWLAN:ANALysis:OFFSet <value>
[:SENSe]:SWLAN:ANALysis:OFFSet?

Arguments <value>::=<NRf> specifies the analysis offset in seconds. Range: 0 to 100 ms.

Measurement Modes DEMSWLAN

Examples :SENSe:SWLAN:ANALysis:OFFSet 50m
sets the analysis range to 50 ms.

[[:SENSe]:SWLAN:ANALysis:SFORmat(?)

Selects or queries the signal format for the transfer function and delay profile measurements in the 802.11n (nx1) analysis. This command is valid when [:SENSe]:SWLAN:MEASurement is set to ATFunction, PTFunction, or DPRofile.

Syntax [:SENSe]:SWLAN:ANALysis:SFORmat { ONE | TWO }
[:SENSe]:SWLAN:ANALysis:SFORmat?

Arguments ONE selects the communication by one transmitting antenna.
TWO selects the communication by two transmitting antennas.

Measurement Modes DEMSWLAN

Examples :SENSe:SWLAN:ANALysis:SFORmat TWO
selects the communication by two transmitting antennas.

Related Commands [:SENSe]:SWLAN:MEASurement

[:SENSE]:SWLAN:ANALYSIS:SYNC(?)

Selects or queries the synchronization method for the analysis.

Syntax [:SENSE]:SWLAN:ANALYSIS:SYNC { LTFIELD | PILOT }
[:SENSE]:SWLAN:ANALYSIS:SYNC?

Arguments LTFIELD specifies to synchronize with the long training field.
PILOT specifies to synchronize with the pilot signals.

Measurement Modes DEMSWLAN

Examples :SENSE:SWLAN:ANALYSIS:SYNC LTFIELD
specifies to synchronize with the long training field.

[[:SENSe]:SWLAN:BLOCK(?)]

Sets or queries the number of the block to measure in the 802.11n (nx1) analysis.

Syntax [:SENSe]:SWLAN:BLOCK <value>
 [:SENSe]:SWLAN:BLOCK?

Arguments <value>::=<NR1> specifies the block number. Zero represents the latest block.
 Range: -M to 0 (M: the number of acquired blocks)

Measurement Modes DEMSWLAN

Examples :SENSe:SWLAN:BLOCK -5
 sets the block number to -5.

[[:SENSe]:SWLAN[:IMMEDIATE] (No Query Form)]

Runs the demodulation calculation for the acquired data in the 802.11n (nx1) analysis. To select the measurement item, use the [:SENSe]:SWLAN:MEASUREMENT command. To acquire data, use the :INITIATE command.

Syntax [:SENSe]:SWLAN[:IMMEDIATE]

Arguments None

Measurement Modes DEMSWLAN

Examples :SENSe:SWLAN:IMMEDIATE
 runs the demodulation calculation for the acquired data.

Related Commands :INITIATE, [:SENSe]:SWLAN:MEASUREMENT

[[:SENSE]:SWLAN:MEASurement(?)]

Selects or queries the measurement item in the 802.11n (nx1) analysis. To acquire data, use the :INITiate command. To start the analysis, use the [[:SENSE]:SWLAN[:IMMEDIATE]] command.

Syntax [[:SENSE]:SWLAN:MEASurement { ATFunction | PTFUNCTION | DPRofile | EVTime | PVTime | CONSTe | EVSC | PVSC | SCConste | FERRor | OFLatness | OLINearity | STABLE | SMASK | OFF }

[[:SENSE]:SWLAN:MEASurement?

Arguments Table 2-120 shows the measurement selections.

Table 2-120: Measurements, 802.11n (nx1)

Argument	Measurement item
ATFunction	Transfer Function (Amplitude)
PTFunction	Transfer Function (Phase)
DPRofile	Delay Profile
EVTime	EVM versus Time
PVTime	Power versus Time
CONSTe	Constellation
EVSC	EVM versus Subcarrier
PVSC	Power versus Subcarrier
SCConste	Subcarrier constellation
FERRor	Frequency error
OFLatness	OFDM flatness
OLINearity	OFDM linearity
STABLE	Symbol table
SMASK	Spectrum mask
OFF	Measurement off

Measurement Modes DEMSWLAN

Examples :SENSE:SWLAN:MEASurement ATFunction
selects the Transfer Function (Amplitude).

Related Commands :INITiate, [[:SENSE]:SWLAN[:IMMEDIATE]]

[[:SENSe]:SWLAN:PACKet[:NUMBer](?)

Sets or queries the packet number to measure.

Syntax [:SENSe]:SWLAN:PACKet[:NUMBer] <number>
 [:SENSe]:SWLAN:PACKet[:NUMBer]?

Arguments <number>: :=<NR1> specifies the packet number.
 Range: -[(the number of packets in the analysis range) - 1] to 0.
 Zero (0) represents the latest packet.

Measurement Modes DEMSWLAN

Examples :SENSe:SWLAN:PACKet:NUMBer -10
 sets the packet number to -10.

[[:SENSe]:SWLAN:SMASk[:SElect](?)

Selects or queries the transmit spectral mask specified in the 802.11n standard.

Syntax [:SENSe]:SWLAN:SMASk[:SElect] { EFFective | INValid }
 [:SENSe]:SWLAN:SMASk[:SElect]?

Arguments EFFective selects the mask for 20 MHz transmission.
 INValid selects the mask for 40 MHz transmission.

Measurement Modes DEMSWLAN

Examples :SENSe:SWLAN:SMASk:SElect EFFective
 selects the mask for 20 MHz transmission.

[[:SENSE]:SWLAN:SPECTrum:OFFSet(?)]

Sets or queries the spectrum offset within the acquisition length. Spectrum Offset is the beginning of Spectrum Length to display spectrum in the subview.

Syntax [[:SENSE]:SWLAN:SPECTrum:OFFSet <value>
[[:SENSE]:SWLAN:SPECTrum:OFFSet?

Arguments <value>::=<NRf> specifies the spectrum offset in seconds. Range: 0 to 100 ms.

Measurement Modes DEMSWLAN

Examples :SENSE:SWLAN:SPECTrum:OFFSet 20m
sets the spectrum offset to 20 ms.

[[:SENSE]:SWLAN:SSEGment[:NUMBER](?)]

Sets or queries the symbol (segment) number. This command is valid when [[:SENSE]:SWLAN:MEASurement] is set to ATFunction, PTFunction, DPRofile, EVSC, PVSC, SCConste, or STABLE.

Syntax [[:SENSE]:SWLAN:SSEGment[:NUMBER] <number>
[[:SENSE]:SWLAN:SSEGment[:NUMBER]?

Arguments <number>::=<NR1> specifies the symbol number.
Range: -[(the number of symbols in the analysis range) - 1] to 0.
Zero (0) represents the latest symbol.

Measurement Modes DEMSWLAN

Examples :SENSE:SWLAN:SSEGment:NUMBER -52
sets the symbol number to -52.

Related Commands [[:SENSE]:SWLAN:MEASurement

[[:SENSe]:SWLAN:SUBCarrier[:NUMBer](?)

Sets or queries the subcarrier number when [:SENSe]:SWLAN:SUBCarrier:SELEct is set to SSUBcarrier.

Syntax [:SENSe]:SWLAN:SUBCarrier[:NUMBer] <number>
 [:SENSe]:SWLAN:SUBCarrier[:NUMBer]?

Arguments <number>::=<NR1> specifies the subcarrier number.
 Range: -64 to +63.

Measurement Modes DEMSWLAN

Examples :SENSe:SWLAN:SUBCarrier:NUMBer 10
 sets the subcarrier number to 10.

Related Commands [:SENSe]:SWLAN:SUBCarrier:SELEct

[[:SENSE]:SWLAN:SUBCarrier:SElect(?)]

Selects or queries the subcarrier(s) to display.

Syntax [:SENSE]:SWLAN:SUBCarrier:SElect
 { DATA | PILOt | BOTH | SSUBcarrier }

[:SENSE]:SWLAN:SUBCarrier:SElect?

Arguments DATA selects the data only.

 PILOt selects the pilot only.

 BOTH selects the data and the pilot (default).

 SSUBcarrier selects the subcarrier specified using the [:SENSE]:SWLAN
 :SUBCarrier[:NUMBer] command (Single Subcarrier). This selection is effective
 in the EVM versus Time, Power versus Time, and Constellation measurements.

Measurement Modes DEMSWLAN

Examples :SENSE:SWLAN:SUBCarrier:SElect DATA
 selects the data only.

Related Commands [:SENSE]:SWLAN:SUBCarrier[:NUMBer],
 :DISPlay:SWLAN:DDEMod:SVIew:FORMat

[[:SENSe]:SWLAN:TXAntenna:SElect (?)]

Selects or queries the transmission antenna to display the measurement results.

Syntax [:SENSe]:SWLAN:TXAntenna:SElect { ONE | TWO }

[:SENSe]:SWLAN:TXAntenna:SElect?

Arguments ONE displays the measurement results for signals transmitted by Tx Antenna 1.

TWO displays the measurement results for signals transmitted by Tx Antenna 2.

Measurement Modes DEMSWLAN

Examples :SENSe:SWLAN:TXAntenna:SElect ONE
selects Tx Antenna 1 to display the measurement results.

[:SENSe]:WLAN Subgroup**WLAN, Option 29 Only**

The [:SENSe]:SWLAN commands set up the conditions related to the IEEE802.11a/b/g analysis.

NOTE. To use a command from this group, you must have selected DEMWLAN (IEEE802.11a/b/g analysis) in the :INSTRument[:SElect] command.

Command Tree	Header	Parameter
	[:SENSe]	
	:WLAN	
	:ACQuisition	
	:HISTory	<numeric_value>
	:SEConds	<numeric_value>
	:ANALysis	
	:EQUalization	
	[:STATe]	<boolean>
	:LENGth	<numeric_value>
	:MODulation	AUTO 064QH 064QL 016QH 016QL OQH OQL OBH OBL CCKH CCKL DDQ DDB P8PH P8PL PQH PBL
	:OFFSet	<numeric_value>
	:SYNC	LTSymbol GI
	:BLOCK	<numeric_value>
	[:IMMediate]	
	:MEASurement	PVTime EVTime PVSC EVSC CONSte SCConste FERRor OFLatness OLINearity STABle SMASk TPOWer OFF
	:SMASk	
	[:SElect]	DSSS OFDM
	:SPECTrum	
	:OFFSet	<numeric_value>
	:SSEGment	
	[:NUMBer]	<numeric_value>
	:SUBCarrier	
	[:NUMBer]	<numeric_value>
	:SElect	DATA PIlot BOTH SSUBcarrier
	:TPOWer	
	:BURSt	
	:INDEX	<numeric_value>
	:SLOPe	POSitive NEGative

[[:SENSe]:WLAN:ACQuisition:HISTory(?)]

Sets or queries an acquisition history (serial number assigned to each acquisition) to display or analyze the data.

Arguments [:SENSe]:WLAN:ACQuisition:HISTory <value>

[:SENSe]:WLAN:ACQuisition:HISTory?

Arguments <value>::=<NRf> sets the acquisition history. The maximum value is zero that represents the latest. The minimum value depends on span and memory length. You can see it with [:SENSe]:WLAN:ACQuisition:HISTory? MINimum.

Measurement Modes DEMWLAN

Examples :SENSe:WLAN:ACQuisition:HISTory -100
sets the acquisition history to -100.

[[:SENSe]:WLAN:ACQuisition:SEConds(?)]

Sets or queries the acquisition length in seconds.

Syntax [:SENSe]:WLAN:ACQuisition:SEConds <value>

[:SENSe]:WLAN:ACQuisition:SEConds?

Arguments <value>::=<NRf> sets the acquisition length. The minimum value is 20 μ s. The minimum value depends on span and memory length. You can see it with [:SENSe]:WLAN:ACQuisition:SEConds? MAXimum.

Measurement Modes DEMWLAN

Examples :SENSe:WLAN:ACQuisition:SEConds 2.5m
sets the acquisition length to 2.5 ms.

[[:SENSE]:WLAN:ANALYSIS:EQUALIZATION[:STATE](?)

Determines whether to enable or disable the data correction for the long training symbol during the analysis.

Syntax [:SENSE]:WLAN:ANALYSIS:EQUALIZATION[:STATE] { 0 | 1 | OFF | ON }
 [:SENSE]:WLAN:ANALYSIS:EQUALIZATION[:STATE]?

Arguments OFF or 0 disables the correction function.
 ON or 1 enables the correction function.

Measurement Modes DEM WLAN

Examples :SENSE:WLAN:ANALYSIS:EQUALIZATION:STATE ON
 enables the correction function.

[[:SENSE]:WLAN:ANALYSIS:LENGTH(?)

Sets or queries the time length for the IEEE802.11a/b/g analysis.

Syntax [:SENSE]:WLAN:ANALYSIS:LENGTH <value>
 [:SENSE]:WLAN:ANALYSIS:LENGTH?

Arguments <value>::=<NRf> specifies the analysis range in seconds. Range: 0 to 100 ms.

Measurement Modes DEM WLAN

Examples :SENSE:WLAN:ANALYSIS:LENGTH 50m
 sets the analysis range to 50 ms.

[:SENSe]:WLAN:ANALysis:MODulation(?)

Selects or queries the modulation type for analysis.

Syntax [:SENSe]:WLAN:ANALysis:MODulation { AUTO | 064QH | 064QL
| 016QH | 016QL | 0QH | 0QL | 0BH | 0BL | CCKH | CCKL | DDQ | DDB
| P8PH | P8PL | PQH | PBL }
[:SENSe]:WLAN:ANALysis:MODulation?

Arguments Table 2-121 shows the modulation type selections.

Table 2- 121: Modulation type selections

Argument	Data rate	Modulation 1 st /2 nd	Encoding rate
AUTO (default)	Auto	Auto	
064QH	54 Mbps	64QAM/OFDM	3/4
064QL	48 Mbps	64QAM/OFDM	2/3
016QH	36 Mbps	16QAM/OFDM	3/4
016QL	24 Mbps	16QAM/OFDM	1/2
0QH	18 Mbps	QPSK/OFDM	3/4
0QL	12 Mbps	QPSK/OFDM	1/2
0BH	9 Mbps	BPSK/OFDM	3/4
0BL	6 Mbps	BPSK/OFDM	1/2
CCKH	11 Mbps	CCK	
CCKL	5.5 Mbps	CCK	
DDQ	2 Mbps	DQPSK/DSSS	
DDB	1 Mbps	DBPSK/DSSS	
P8PH	33 Mbps	8PSK/PBCC	
P8PL	22 Mbps	8PSK/PBCC	
PQH	11 Mbps	QPSK/PBCC	
PBL	5.5 Mbps	BPSK/PBCC	

Measurement Modes DEMWLAN

Examples :SENSe:WLAN:ANALysis:MODulation 064QH
selects 64QAM/OFDM (54 Mbps) modulation.

[[:SENSE]:WLAN:ANALYSIS:OFFSET(?)]

Sets or queries the measurement start position in the IEEE802.11a/b/g analysis.

Syntax [:SENSE]:WLAN:ANALYSIS:OFFSET <value>
 [:SENSE]:WLAN:ANALYSIS:OFFSET?

Arguments <value>::=<NRf> specifies the analysis offset in seconds. Range: 0 to 100 ms.

Measurement Modes DEMWLAN

Examples :SENSE:WLAN:ANALYSIS:OFFSET 50m
 sets the analysis range to 50 ms.

[[:SENSE]:WLAN:ANALYSIS:SYNC(?)]

Selects or queries the synchronization function for the long training symbol during the analysis.

Syntax [:SENSE]:WLAN:ANALYSIS:SYNC { LTSymbol | GI }
 [:SENSE]:WLAN:ANALYSIS:SYNC?

Arguments LTSymbol specifies to synchronize with the long training symbol.
 GI specifies to synchronize with the guard interval.

Measurement Modes DEMWLAN

Examples :SENSE:WLAN:ANALYSIS:SYNC LTSymbol
 specifies to synchronize with the long training symbol.

[[:SENSe]:WLAN:BLOCK(?)]

Sets or queries the number of the block to measure in the IEEE802.11a/b/g analysis.

Syntax [[:SENSe]:WLAN:BLOCK <value>

[[:SENSe]:WLAN:BLOCK?

Arguments <value> ::= <NR1> specifies the block number. Zero represents the latest block. Range: -M to 0 (M: the number of acquired blocks)

Measurement Modes DEMWLAN

Examples :SENSe:WLAN:BLOCK -5
sets the block number to -5.

[[:SENSe]:WLAN[:IMMEDIATE]] (No Query Form)

Runs the demodulation calculation for the acquired data in the IEEE802.11a/b/g analysis. To select the measurement item, use the [[:SENSe]:WLAN:MEASurement] command. To acquire data, use the :INITiate command.

Syntax [[:SENSe]:WLAN[:IMMEDIATE]]

Arguments None

Measurement Modes DEMWLAN

Examples :SENSe:WLAN:IMMEDIATE
runs the demodulation calculation for the acquired data.

Related Commands :INITiate, [[:SENSe]:WLAN:MEASurement]

[[:SENSE]:WLAN:MEASUREMENT(?)]

Selects or queries the measurement item in the IEEE802.11a/b/g analysis. To acquire data, use the :INITiate command. To start the analysis, use the [[:SENSE]:WLAN[:IMMEDIATE]] command.

Syntax [[:SENSE]:WLAN:MEASUREMENT { PVTIME | EVTIME | PVSC | EVSC
| CONSTE | SCCONSTE | FERROR | OFLATNESS | OLINEARITY | STABLE
| SMASK | TPOWER | OFF }
[[:SENSE]:WLAN:MEASUREMENT?

Arguments Table 2-122 shows the measurement selections.

Table 2-122: Measurement selections

Argument	Measurement item
PVTIME	Power versus Time
EVTIME	EVM versus Time
PVSC	Power versus Subcarrier
EVSC	EVM versus Subcarrier
CONSTE	Constellation
SCCONSTE	Subcarrier constellation
FERROR	Frequency error
OFLATNESS	OFDM flatness
OLINEARITY	OFDM linearity
STABLE	Symbol table
SMASK	Spectrum mask
TPOWER	Transmit power
OFF	Measurement off

Measurement Modes DEMWLAN

Examples :SENSE:WLAN:MEASUREMENT PVTIME
selects the power versus time measurement.

Related Commands :INITiate, [[:SENSE]:WLAN[:IMMEDIATE]]

[[:SENSe]:WLAN:SMASk[:SElect](?)

Selects or queries the signal type for the specrum mask measurement.

Syntax [:SENSe]:WLAN:SMASk[:SElect] { DSSS | OFDM }
 [:SENSe]:WLAN:SMASk[:SElect]?

Arguments DSSS selects the DSSS (Direct Sequence Spread Spectrum) signal.
 OFDM selects the OFDM (Orthogonal Frequency Division Multiplexing) signal.

Measurement Modes DEM WLAN

Examples :SENSe:WLAN:SMASk:SElect DSSS
 selects the DSSS signal for the specrum mask measurement.

[[:SENSe]:WLAN:SPEctrum:OFFSet(?)

Sets or queries the spectrum offset within the acquisition length.
Spectrum Offset is the beginning of Spectrum Length to display spectrum in the subview.

Syntax [:SENSe]:WLAN:SPEctrum:OFFSet <value>
 [:SENSe]:WLAN:SPEctrum:OFFSet?

Arguments <value>::=<NRf> specifies the spectrum offset in seconds. Range: 0 to 100 ms.

Measurement Modes DEM WLAN

Examples :SENSe:WLAN:SPEctrum:OFFSet 20m
 sets the spectrum offset to 20 ms.

[:SENSe]:WLAN:SSEGment[:NUMBER](?)

Sets or queries the symbol (segment) number.

This command is valid when :DISPlay:WLAN:DDEMod:SVIew:FORMat is set to PVSC, EVSC, SSConste, or STABLE.

Syntax [:SENSe]:WLAN:SSEGment[:NUMBER] <number>
[:SENSe]:WLAN:SSEGment[:NUMBER]?

Arguments <number>::=<NR1> specifies the symbol number. Range: 0 to 14285.

Measurement Modes DEMWLAN

Examples :SENSe:WLAN:SSEGment:NUMBER 150
sets the symbol number to 150.

Related Commands :DISPlay:WLAN:DDEMod:SVIew:FORMat

[:SENSe]:WLAN:SUBCarrier[:NUMBER](?)

Sets or queries the subcarrier number when [:SENSe]:WLAN:SUBCarrier:SElect is set to SSUBcarrier.

Syntax [:SENSe]:WLAN:SUBCarrier[:NUMBER] <number>
[:SENSe]:WLAN:SUBCarrier[:NUMBER]?

Arguments <number>::=<NR1> specifies the subcarrier number.
Range: -26 to -1, +1 to +26 (not permit 0)

Measurement Modes DEMWLAN

Examples :SENSe:WLAN:SUBCarrier:NUMBER 10
sets the subcarrier number to 10.

Related Commands [:SENSe]:WLAN:SUBCarrier:SElect

[[:SENSe]:WLAN:SUBCarrier:SElect(?)

Selects or queries the subcarrier(s) to display.

Syntax [:SENSe]:WLAN:SUBCarrier:SElect
 { DATA | PILOt | BOTH | SSUBcarrier }

 [:SENSe]:WLAN:SUBCarrier:SElect?

Arguments DATA selects the data only.

 PILOt selects the pilot only.

 BOTH selects the data and the pilot (default).

 SSUBcarrier selects the subcarrier specified using the [:SENSe]:WLAN:SUB-Carrier[:NUMBER] command (Single Subcarrier). This selection is effective in the EVM versus Time, Power versus Time, and Constellation measurements.

Measurement Modes DEM WLAN

Examples :SENSe:WLAN:SUBCarrier:SElect DATA
 selects the data only.

Related Commands [:SENSe]:WLAN:SUBCarrier[:NUMBER],
 :DISPlay:WLAN:DDEMod:SVIew:FORMat

[[:SENSE]:WLAN:TPOWER:BURSt:INDEX(?)]

Sets or queries the burst index to display the measurement results in the transmit power measurement.

Syntax [[:SENSE]:WLAN:TPOWER:BURSt:INDEX <number>

[[:SENSE]:WLAN:TPOWER:BURSt:INDEX?

Arguments <number>::=<NR1> specifies the burst index. Zero represents the latest burst. Range: -N to 0 (N: the number of analyzed bursts -1)

Measurement Modes DEMWLAN

Examples :SENSE:WLAN:TPOWER:BURSt:INDEX -10
sets the burst index to -10.

[[:SENSE]:WLAN:TPOWER:SLOPe(?)]

Selects or queries the transmit power ramp for the transmit power measurement.

Syntax [[:SENSE]:WLAN:TPOWER:SLOPe { POSitive | NEGative }

[[:SENSE]:WLAN:TPOWER:SLOPe?

Arguments POSitive selects the power-on ramp.
NEGative selects the power-down ramp.

Measurement Modes DEMWLAN

Examples :SENSE:WLAN:TPOWER:SLOPe POSitive
selects the power-on ramp.

[[:SENSe]:DLR6_3GPP Subgroup**3GPP-R6, Option 40 Only**

The [[:SENSe]:DLR6_3GPP commands set up conditions for the 3GPP-R6 downlink modulation analysis.

NOTE. To use a command from this group, you must have selected *DEMDLR6_3G* (3GPP-R6 downlink modulation analysis mode) using the *:INSTrument[:SELEct]* command.

Command Tree	Header	Parameter
	[[:SENSe]	
	:DLR6_3GPP	
	:BLock	<numeric_value>
	:CARRier	
	:OFFSet	<frequency>
	:SEARch	<boolean>
	:CCODE	
	:EAGCh	<numeric_value>
	:ERGCh	<numeric_value>
	:COMPOSITE	<boolean>
	:DTYPE	
	:SEARch	<boolean>
	:EVM	
	:IQOffset	INCLude EXCLude
	:FILTer	
	:ALPHa	<ratio>
	:MEASurement	OFF RRCosine
	:REFerence	OFF RCOSine GAUSSian
	[[:IMMediate]	
	:LENGth	<numeric_value>
	:OFFSet	<numeric_value>
	:SCHPart	<boolean>
	:SCODE	
	:ALTerNative	NUSEd PRIMary LEFT RIGHT
	:NUMBer	<code_number>
	:SEARch	<boolean>
	:SSINDEX	
	:EHICH	<numeric_value>
	:ERGCh	<numeric_value>
	:UTSTable	

[[:SENSe]:DLR6_3GPP:BLOCK(?)]

Sets or queries the number of the block to measure in the 3GPP-R6 downlink analysis.

Syntax [:SENSe]:DLR6_3GPP:BLOCK <number>

[:SENSe]:DLR6_3GPP:BLOCK?

Arguments <number>: :=<NR1> specifies the block number.
Zero represents the latest block.
Range: -M to 0 (M: Number of acquired blocks).

Measurement Modes DEMDLR6_3G

Examples :SENSe:DLR6_3GPP:BLOCK -5
sets the block number to -5.

[[:SENSe]:DLR6_3GPP:CARRier:OFFSet(?)]

Sets or queries the carrier frequency offset in the 3GPP-R6 downlink analysis.

Syntax [:SENSe]:DLR6_3GPP:CARRier:OFFSet <freq>
 [:SENSe]:DLR6_3GPP:CARRier:OFFSet?

Arguments <freq>: :=<NRf> specifies the carrier frequency offset.
 Range: -Fs to Fs (Fs: Span)

Measurement Modes DEMDLR6_3G

Examples :SENSe:DLR6_3GPP:CARRier:OFFSet 10MHz
 sets the carrier frequency offset to 10 MHz.

[[:SENSe]:DLR6_3GPP:CARRier:SEARch(?)]

Determines whether to detect the carrier automatically in the 3GPP-R6 downlink analysis.

Syntax [:SENSe]:DLR6_3GPP:CARRier:SEARch { OFF | ON | 0 | 1 }
 [:SENSe]:DLR6_3GPP:CARRier:SEARch?

Arguments OFF or 0 specifies that the carrier is not detected automatically. To set the carrier frequency offset, use the [:SENSe]:DLR6_3GPP:CARRier:OFFSet command.
 ON or 1 specifies that the carrier is detected automatically.

Measurement Modes DEMDLR6_3G

Examples :SENSe:DLR6_3GPP:CARRier:SEARch ON
 specifies that the carrier is detected automatically.

[[:SENSe]:DLR6_3GPP:CCODE:EAGCh(?)

Sets or queries the channelization code number of E-AGCH in the 3GPP-R6 downlink analysis.

Syntax [[:SENSe]:DLR6_3GPP:CCODE:EAGCh <number>

[[:SENSe]:DLR6_3GPP:CCODE:EAGCh?

Arguments <number>::=<NR1> specifies the channelization code number of E-AGCH. Range: 0 to 127.

Measurement Modes DEMDLR6_3G

Examples :SENSe:DLR6_3GPP:CCODE:EAGCh 85
sets the channelization code number to 85.

[[:SENSe]:DLR6_3GPP:CCODE:ERGCh(?)

Sets or queries the channelization code number of E-RGCH and E-HICH in the 3GPP-R6 downlink analysis.

Syntax [[:SENSe]:DLR6_3GPP:CCODE:ERGCh <number>

[[:SENSe]:DLR6_3GPP:CCODE:ERGCh?

Arguments <number>::=<NR1> specifies the channelization code number of E-RGCH and E-HICH. Range: 0 to 127.

Measurement Modes DEMDLR6_3G

Examples :SENSe:DLR6_3GPP:CCODE:ERGCh 28
sets the channelization code number to 28.

[[:SENSe]:DLR6_3GPP:COMPOSITE(?)]

Determines whether to perform the composite analysis (automatic detection of symbol rate) in the 3GPP-R6 downlink analysis.

Syntax [:SENSe]:DLR6_3GPP:COMPOSITE { OFF | ON | 0 | 1 }
 [:SENSe]:DLR6_3GPP:COMPOSITE?

Arguments OFF or 0 specifies that composite analysis is not performed.
 ON or 1 specifies that composite analysis is performed.

NOTE. *You should usually specify that composite analysis is performed. If a normal analysis does not result, select OFF in this command and select a specific symbol rate in :DISPlay:DLR6_3GPP:AVIEW:SRATE.*

Measurement Modes DEMDLR6_3G

Examples :SENSe:DLR6_3GPP:COMPOSITE ON
 specifies that the composite analysis is performed.

Related Commands :DISPlay:DLR6_3GPP:AVIEW:SRATE

[[:SENSe]:DLR6_3GPP:DTYPe:SEARch(?)

Determines whether to detect the demodulation type of the code channel (QPSK or 16QAM) automatically.

Syntax [:SENSe]:DLR6_3GPP:DTYPe:SEARch { OFF | ON | 0 | 1 }
 [:SENSe]:DLR6_3GPP:DTYPe:SEARch?

Arguments OFF or 0 specifies that the code channel is QPSK.
 ON or 1 specifies that the code channel is automatically detected (QPSK or 16QAM).

Measurement Modes DEMDLR6_3G

Examples :SENSe:DLR6_3GPP:DTYPe:SEARch ON
 specifies that the code channel is automatically detected.

[[:SENSe]:DLR6_3GPP:EVM:IQOoffset(?)

Determines whether to include the I/Q origin offset in the EVM (Error Vector Magnitude), Rho (waveform quality), and PCDE (Peak Code Domain Error) calculation.

Syntax [:SENSe]:DLR6_3GPP:EVM:IQOoffset { INCLude | EXCLude }
 [:SENSe]:DLR6_3GPP:EVM:IQOoffset?

Arguments INCLude includes the I/Q origin offset in the EVM, Rho, and PCDE calculation.
 EXCLude excludes the I/Q origin offset from the calculation.

Measurement Modes DEMDLR6_3G

Examples :SENSe:DLR6_3GPP:IQOoffset INCLude
 includes the I/Q origin offset in the calculation.

[[:SENSe]:DLR6_3GPP:FILTer:ALPHa(?)]

Sets or queries the filter factor (a/BT) in the 3GPP-R6 downlink analysis.

Syntax [[:SENSe]:DLR6_3GPP:FILTer:ALPHa <value>

[[:SENSe]:DLR6_3GPP:FILTer:ALPHa?

Arguments <value>::=<NRf> specifies the filter factor (a/BT). Range: 0 to 1.

Measurement Modes DEMDLR6_3G

Examples :SENSe:DLR6_3GPP:FILTer:ALPHa 0.5
sets the filter factor to 0.5.

[:SENSE]:DLR6_3GPP:FILTer:MEASurement(?)

Selects or queries the measurement filter in the 3GPP-R6 downlink analysis.

Syntax [:SENSE]:DLR6_3GPP:FILTer:MEASurement { OFF | RRCosine }
[:SENSE]:DLR6_3GPP:FILTer:MEASurement?

Arguments OFF specifies that no measurement filter is used.
RRCosine selects the Root Raised Cosine filter.

Measurement Modes DEMDLR6_3G

Examples :SENSE:DLR6_3GPP:FILTer:MEASurement RRCosine
selects the Root Raised Cosine filter as the measurement filter.

[:SENSE]:DLR6_3GPP:FILTer:REFerence(?)

Selects or queries the reference filter in the 3GPP-R6 downlink analysis.

Syntax [:SENSE]:DLR6_3GPP:FILTer:REFerence { OFF | RCOSine | GAUSSian }
[:SENSE]:DLR6_3GPP:FILTer:REFerence?

Arguments OFF specifies that no reference filter is used.
RCOSine selects the Raised Cosine filter.
GAUSSian selects the Gaussian filter.

Measurement Modes DEMDLR6_3G

Examples :SENSE:DLR6_3GPP:FILTer:REFerence RCOSine
selects the Raised Cosine filter as the reference filter.

[[:SENSe]:DLR6_3GPP[:IMMediate] (No Query Form)

Runs the 3GPP-R6 downlink analysis calculation on the acquired data.
To acquire data, use the :INITiate command.

Syntax [[:SENSe]:DLR6_3GPP[:IMMediate]

Arguments None

Measurement Modes DEMDLR6_3G

Examples :SENSe:DLR6_3GPP:IMMediate
runs the 3GPP-R6 downlink analysis calculation.

Related Commands :INITiate

[[:SENSe]:DLR6_3GPP:LENGth(?)

Defines or queries the range for the 3GPP-R6 downlink analysis.

Syntax [[:SENSe]:DLR6_3GPP:LENGth <value>
[[:SENSe]:DLR6_3GPP:LENGth?

Arguments <value>::=<NRf> specifies the analysis range by the number of data points.
Range: 1 to 1024 × (block size).
To set the block size, use the [[:SENSe]:BSIZE command.

Measurement Modes DEMDLR6_3G

Examples :SENSe:DLR6_3GPP:LENGth 1000
sets the length of the analysis range to 1000 points.

Related Commands [[:SENSe]:BSIZE

[[:SENSE]:DLR6_3GPP:OFFSet(?)]

Sets or queries the measurement start position in the 3GPP-R6 downlink analysis.

Syntax [:SENSE]:DLR6_3GPP:OFFSet <value>
 [:SENSE]:DLR6_3GPP:OFFSet?

Arguments <value>::=<NRf> specifies the measurement start position by the number of data points. Range: 0 to $1024 \times (\text{block size}) - 1$.
 To set the block size, use the [:SENSE]:BSIZE command.

Measurement Modes DEMDLR6_3G

Examples :SENSE:DLR6_3GPP:OFFSet 100
 sets the measurement start position to point 100.

Related Commands [:SENSE]:BSIZE

[[:SENSE]:DLR6_3GPP:SCHPart(?)]

Determines whether to include the SCH part in the analysis.

Syntax [:SENSE]:DLR6_3GPP:SCHPart { OFF | ON | 0 | 1 }
 [:SENSE]:DLR6_3GPP:SCHPart?

Arguments OFF or 0 specifies that the SCH part is not included in the analysis.
 ON or 1 specifies that the SCH part is included in the analysis.

Measurement Modes DEMDLR6_3G

Examples :SENSE:DLR6_3GPP:SCHPart ON
 specifies that the SCH part is included in the analysis.

[[:SENSe]:DLR6_3GPP:SCODE:ALternative(?)]

Selects or queries the alternative scrambling code in the 3GPP-R6 downlink modulation analysis.

Syntax [:SENSe]:DLR6_3GPP:SCODE:ALternative { NUSed | PRIMary
 | LEFT | RIGHT }

[:SENSe]:DLR6_3GPP:SCODE:ALternative?

Arguments NUSed (default) uses the primary scrambling code only (without the left and the right alternative scrambling codes) to de-spread the input signal.

PRIMary uses the primary scrambling with the left and the right alternative scrambling codes to de-spread the input signal.

LEFT uses the left alternative scrambling code to de-spread the input signal.

RIGHT uses the right alternative scrambling code to de-spread the input signal.
Measurement Modes

Measurement Modes DEMDLR6_3G

Examples :SENSe:DLR6_3GPP:SCODE:ALternative RIGHT
 uses the right alternative scrambling code to de-spread the input signal.

[[:SENSe]:DLR6_3GPP:SCODE:NUMBER(?)]

Sets or queries the scrambling code in the 3GPP-R6 downlink analysis.

Syntax [:SENSe]:DLR6_3GPP:SCODE:NUMBER <value>
 [:SENSe]:DLR6_3GPP:SCODE:NUMBER?

Arguments <value>::=<NR1> specifies the scrambling code. Range: 0 to 24575.

Measurement Modes DEMDLR6_3G

Examples :SENSe:DLR6_3GPP:SCODE:NUMBER 3
 sets the scrambling code to 3.

Related Commands [:SENSe]:DLR6_3GPP:SCODE:SEARCh

[[:SENSe]:DLR6_3GPP:SCODE:SEARCh(?)]

Determines whether automatic detection of the scrambling code is on or off in the 3GPP-R6 downlink analysis.

Syntax [:SENSe]:DLR6_3GPP:SCODE:SEARCh { OFF | ON | 0 | 1 }
 [:SENSe]:DLR6_3GPP:SCODE:SEARCh?

Arguments OFF or 0 specifies that the scrambling code is not detected automatically.
 To set it, use the [:SENSe]:DLR6_3GPP:SCODE:NUMBER command above.

ON or 1 specifies that the scrambling code is detected automatically.

Measurement Modes DEMDLR6_3G

Examples :SENSe:DLR6_3GPP:SCODE:SEARCh ON
 specifies that the scrambling code is detected automatically.

Related Commands [:SENSe]:DLR6_3GPP:SCODE:NUMBER

[[:SENSe]:DLR6_3GPP:SSINdex:EHICH(?]

Sets or queries the signature sequence index number of E-HICH in the 3GPP-R6 downlink analysis.

Syntax [[:SENSe]:DLR6_3GPP:CCODE:EGCh <number>

[[:SENSe]:DLR6_3GPP:CCODE:EGCh?

Arguments <number>::=<NR1> specifies the signature sequence index number of E-HICH.
Range: 0 to 39.

Measurement Modes DEMDLR6_3G

Examples :SENSe:DLR6_3GPP:CCODE:EGCh 12
sets the signature sequence index number to 12.

[[:SENSe]:DLR6_3GPP:SSINdex:ERGCh(?]

Sets or queries the signature sequence index number of E-RGCH in the 3GPP-R6 downlink analysis.

Syntax [[:SENSe]:DLR6_3GPP:CCODE:ERGCh <number>

[[:SENSe]:DLR6_3GPP:CCODE:ERGCh?

Arguments <number>::=<NR1> specifies the signature sequence index number of E-RGCH.
Range: 0 to 39.

Measurement Modes DEMDLR6_3G

Examples :SENSe:DLR6_3GPP:CCODE:ERGCh 12
sets the signature sequence index number to 12.

[:SENSE]:DLR6_3GPP:UTSTable (No Query Form)

Updates the time-slot table in the main view in the 3GPP-R6 downlink analysis.

Syntax [:SENSE]:DLR6_3GPP:UTSTable

Arguments None

Measurement Modes DEMDLR6_3G

Examples :SENSE:DLR6_3GPP:UTSTable
updates the time-slot table in the main view.

[[:SENSe]:ULR6_3GPP Subgroup**3GPP-R6, Option 40 Only**

The [[:SENSe]:ULR6_3GPP commands set up conditions for the 3GPP-R6 uplink modulation analysis.

NOTE. To use a command from this group, you must have selected *DEMULR6_3G* (3GPP-R6 uplink modulation analysis) using the *:INSTrument[:SELEct]* command.

Command Tree	Header	Parameter
	[[:SENSe]	
	:ULR6_3GPP	
	:BLock	<numeric_value>
	:CARRier	
	:OFFSet	<frequency>
	:SEARch	<boolean>
	:CCONfig	AUTO C1N C2N C3N
	:DFOFormat	AUTO S0F S1F S2F S3F
	:EVM	
	:IQOoffset	INCLude EXCLude
	:TPERiods	INCLude EXCLude
	:FILTer	
	:ALPHa	<numeric_value>
	:MEASurement	OFF RRCosine
	:REFErence	OFF RCOsine GAUSSian
	[:IMMediate]	
	:LENGth	<numeric_value>
	:MMODE	DPCH PRACH PCPCh
	:OFFSet	<numeric_value>
	:SCODE	
	:NUMBer	<numeric_value>
	:TYPE	LONG SHORt
	:SFRame	
	:OFFSet	
	:DTIME	<numeric_value>
	[:STSLot]	<numeric_value>
	:SEARch	AUTO STSLot DTIME
	:THReshold	
	[:BURSt]	<numeric_value>
	:DTX	<numeric_value>
	:TOLerance	<numeric_value>
	:UTSTable	

[[:SENSE]:ULR6_3GPP:BLOCK(?)]

Sets or queries the number of the block to measure in the 3GPP-R6 uplink analysis.

Syntax [:SENSE]:ULR6_3GPP:BLOCK <number>

 [:SENSE]:ULR6_3GPP:BLOCK?

Arguments <number>: :=<NRf> specifies the block number. Zero represents the latest block.
Range: -M to 0 (M: Number of acquired blocks)

Measurement Modes DEMULR6_3G

Examples :SENSE:ULR6_3GPP:BLOCK -5
 sets the block number to -5.

[[:SENSe]:ULR6_3GPP:CARRier:OFFSet(?)]

Sets or queries the carrier frequency offset in the 3GPP-R6 uplink analysis.

Syntax [:SENSe]:ULR6_3GPP:CARRier:OFFSet <freq>
 [:SENSe]:ULR6_3GPP:CARRier:OFFSet?

Arguments <freq>: :=<Nrf> specifies the carrier frequency offset.
 Range: -Fs to Fs (Fs: Span)

Measurement Modes DEMULR6_3G

Examples :SENSe:ULR6_3GPP:CARRier:OFFSet 10MHz
 sets the carrier frequency offset to 10 MHz.

[[:SENSe]:ULR6_3GPP:CARRier:SEARch(?)]

Determines whether to detect the carrier automatically in the 3GPP-R6 uplink analysis.

Syntax [:SENSe]:ULR6_3GPP:CARRier:SEARch { OFF | ON | 0 | 1 }
 [:SENSe]:ULR6_3GPP:CARRier:SEARch?

Arguments OFF or 0 specifies that the carrier is not detected automatically. To set the carrier frequency offset, use the [:SENSe]:ULR6_3GPP:CARRier:OFFSet command.
 ON or 1 specifies that the carrier is detected automatically.

Measurement Modes DEMULR6_3G

Examples :SENSe:ULR6_3GPP:CARRier:SEARch ON
 specifies that the carrier is detected automatically.

Related Commands [:SENSe]:ULR6_3GPP:CARRier:OFFSet

[[:SENSe]:ULR6_3GPP:CCONfig(?)

Selects or queries the channel configuration (defined in the 3GPP-R6 standard).

Syntax [:SENSe]:ULR6_3GPP:CCONfig { AUTO | C1N | C2N | C3N }
 [:SENSe]:ULR6_3GPP:CCONfig?

Arguments Table 2-123 lists the arguments.

Table 2-123: Configuration in 3GPP-R6

Argument	Configuration
AUTO	Detects the configuration automatically
C1N	Configuration #1
C2N	Configuration #2
C3N	Configuration #3

For details on the configuration, refer to the 3GPP-R6 specifications.

Measurement Modes DEMULR6_3G

Examples :SENSe:ULR6_3GPP:CCONfig C1N
 selects Configuration #1.

[[:SENSe]:ULR6_3GPP:DFORmat(?)]

Selects or queries the DPCCH format to decode TFCI in the 3GPP-R6 uplink analysis.

Syntax [:SENSe]:ULR6_3GPP:DFORmat { AUTO | S0F | S1F | S2F | S3F }
[:SENSe]:ULR6_3GPP:DFORmat?

Arguments Table 2-124 lists the arguments.

Table 2- 124: DPCCH format

Argument	DPCCH format
AUTO	Detects the format automatically
S0F	Slot Format #0 (including 0A and 0B)
S1F	Slot Format #1
S2F	Slot Format #2 (including 0A and 0B)
S3F	Slot Format #3

Measurement Modes DEMULR6_3G

Examples :SENSe:ULR6_3GPP:DFORmat S0F
selects Slot Format #0.

[:SENSE]:ULR6_3GPP:EVM:IQOffset(?)

Determines whether to include the I/Q origin offset in the EVM (Error Vector Magnitude), Rho (waveform quality), and PCDE (Peak Code Domain Error) calculation.

Syntax [:SENSE]:ULR6_3GPP:EVM:IQoffset { INCLude | EXCLude }
[:SENSE]:ULR6_3GPP:EVM:IQoffset?

Arguments INCLude includes the I/Q origin offset in the EVM, Rho, and PCDE calculation.
EXCLude excludes the I/Q origin offset from the calculation.

Measurement Modes DEMULR6_3G

Examples :SENSE:ULR6_3GPP:IQoffset INCLude
includes the I/Q origin offset in the calculation.

[:SENSE]:ULR6_3GPP:EVM:TPERiods(?)

Determines whether to include the transient periods (both 25 μ s ends of the time slot) in the EVM (Error Vector Magnitude), Rho (waveform quality), and PCDE (Peak Code Domain Error) calculation.

Syntax [:SENSE]:ULR6_3GPP:EVM:TPERiods { INCLude | EXCLude }
[:SENSE]:ULR6_3GPP:EVM:TPERiods?

Arguments INCLude includes the I/Q origin offset in the EVM, Rho, and PCDE calculation.
EXCLude excludes the I/Q origin offset from the calculation.

Measurement Modes DEMULR6_3G

Examples :SENSE:ULR6_3GPP:TPERiods INCLude
includes the transient periods in the calculation.

[[:SENSe]:ULR6_3GPP:FILTer:ALPHa(?]

Sets or queries the filter factor (a/BT) for the measurement and the reference filters in the 3GPP-R6 uplink analysis.

Syntax `[[:SENSe]:ULR6_3GPP:FILTer:ALPHa <value>`

`[[:SENSe]:ULR6_3GPP:FILTer:ALPHa?`

Arguments `<value>::=<NRf>` specifies the filter factor. Range: 0 to 1.

Measurement Modes DEMULR6_3G

Examples `:SENSe:ULR6_3GPP:FILTer:ALPHa 0.5`
sets the filter factor to 0.5.

[[:SENSe]:ULR6_3GPP:FILTer:MEASurement(?]

Selects or queries the measurement filter in the 3GPP-R6 uplink analysis.

Syntax `[[:SENSe]:ULR6_3GPP:FILTer:MEASurement { OFF | RRCosine }`

`[[:SENSe]:ULR6_3GPP:FILTer:MEASurement?`

Arguments OFF specifies that no measurement filter is used.

RRCosine selects the Root Raised Cosine filter.

Measurement Modes DEMULR6_3G

Examples `:SENSe:ULR6_3GPP:FILTer:MEASurement RRCosine`
selects the Root Raised Cosine filter.

[[:SENSe]:ULR6_3GPP:FILTer:REFeRence(?)

Selects or queries the reference filter in the 3GPP-R6 uplink analysis.

Syntax [:SENSe]:ULR6_3GPP:FILTer:REFeRence { OFF | RCOSine | GAUSSian }
 [:SENSe]:ULR6_3GPP:FILTer:REFeRence?

Arguments OFF specifies that no reference filter is used.
 RCOSine selects the Raised Cosine filter.
 GAUSSian selects the Gaussian filter.

Measurement Modes DEMULR6_3G

Examples :SENSe:ULR6_3GPP:FILTer:REFeRence RCOSine
 selects the Raised Cosine filter.

[[:SENSe]:ULR6_3GPP[:IMMediate] (No Query Form)

Runs the 3GPP-R6 uplink analysis calculation for the acquired data.
 To acquire data, use the :INITiate command.

Syntax [:SENSe]:ULR6_3GPP[:IMMediate]

Arguments None

Measurement Modes DEMULR6_3G

Examples :SENSe:ULR6_3GPP:IMMediate
 runs the 3GPP-R6 uplink analysis calculation.

Related Commands :INITiate

[[:SENSe]:ULR6_3GPP:LENGth(?)]

Defines or queries the range for the 3GPP-R6 uplink analysis.

Syntax [:SENSe]:ULR6_3GPP:LENGth <value>
 [:SENSe]:ULR6_3GPP:LENGth?

Arguments <value>::=<NRf> specifies the analysis range by the number of data points.
Range: 1 to 1024 × (block size).
To set the block size, use the [:SENSe]:BSIZe command.

Measurement Modes DEMULR6_3G

Examples :SENSe:ULR6_3GPP:LENGth 1000
 sets the analysis range to 1000 points.

Related Commands [:SENSe]:BSIZe

[[:SENSe]:ULR6_3GPP:MMOde(?)]

Selects or queries the mobile mode in the 3GPP-R6 uplink analysis.

Syntax [:SENSe]:ULR6_3GPP:MMOde { DPCh | PRACH | PCPCh }
 [:SENSe]:ULR6_3GPP:MMOde?

Arguments DPCh selects the DPDCH/DPCCH mode.
 PRACH selects the PRACH mode.
 PCPCh selects the PCPCH mode.

Measurement Modes DEMULR6_3G

Examples :SENSe:ULR6_3GPP:MMOde PRACH
 selects the PRACH mode.

[[:SENSE]:ULR6_3GPP:OFFSet(?)]

Sets or queries the measurement start position in the 3GPP-R6 uplink analysis.

Syntax [:SENSE]:ULR6_3GPP:OFFSet <value>
 [:SENSE]:ULR6_3GPP:OFFSet?

Arguments <value>::=<NRf> specifies the measurement start position by the number of data points. Range: 0 to $1024 \times (\text{block size}) - 1$.
 To set the block size, use the [:SENSE]:BSIZE command.

Measurement Modes DEMULR6_3G

Examples :SENSE:ULR6_3GPP:OFFSet 100
 sets the measurement start position to point 100.

Related Commands [:SENSE]:BSIZE

[[:SENSe]:ULR6_3GPP:SCODE:NUMBER(?)]

Sets or queries the scrambling code in the 3GPP-R6 uplink analysis.

Syntax [:SENSe]:ULR6_3GPP:SCODE:NUMBER <value>
[:SENSe]:ULR6_3GPP:SCODE:NUMBER?

Arguments <value>::=<NR1> specifies the scrambling code. Range: 0 to 16777215.

Measurement Modes DEMULR6_3G

Examples :SENSe:ULR6_3GPP:SCODE:NUMBER 3
sets the scrambling code to 3.

[[:SENSe]:ULR6_3GPP:SCODE:TYPE(?)]

Selects or queries the scrambling code type.

Syntax [:SENSe]:ULR6_3GPP:SCODE:TYPE { LONG | SHORT }
[:SENSe]:ULR6_3GPP:SCODE:TYPE?

Arguments LONG selects the long code.
SHORT selects the short code.

Measurement Modes DEMULR6_3G

Examples :SENSe:ULR6_3GPP:SCODE:TYPE LONG
selects the long code.

[[:SENSE]:ULR6_3GPP:SFRame:OFFSet:DTIME(?)]

Sets or queries the downlink time offset when [[:SENSE]:ULR6_3GPP:SFRame:SEARCh] is set to DTIME. The downlink time offset is the time offset between the start of HS-SCCH and the start of DPCH (refer to the *RSA3408A Option 27 User Manual*).

Syntax [[:SENSE]:ULR6_3GPP:SFRame:OFFSet:DTIME <value>

[[:SENSE]:ULR6_3GPP:SFRame:OFFSet:DTIME?

Arguments <value>::=<Nrf> specifies the downlink time offset. Range: 0 to 149 symbols.

Measurement Modes DEMULR6_3G

Examples :SENSE:ULR6_3GPP:SFRame:OFFSet:DTIME 35
sets the downlink time offset to 35 symbols.

Related Commands [[:SENSE]:ULR6_3GPP:SFRame:SEARCh]

[[:SENSE]:ULR6_3GPP:SFRame:OFFSet[:STSLot](?)]

Sets or queries the subframe to time-slot offset when [[:SENSE]:ULR6_3GPP:SFRame:SEARCh] is set to STSLot. The subframe to time-slot offset is the time offset between the start of the DPDCH time slot and the start of the HS-DPCCH subframe (refer to the *RSA3408A Option 27 User Manual*).

Syntax [[:SENSE]:ULR6_3GPP:SFRame:OFFSet[:STSLot] <value>

[[:SENSE]:ULR6_3GPP:SFRame:OFFSet[:STSLot]?

Arguments <value>::=<Nrf> specifies the subframe to time-slot offset. Range: 0 to 9 symbols.

Measurement Modes DEMULR6_3G

Examples :SENSE:ULR6_3GPP:SFRame:OFFSet:STSLot 5
sets the subframe to time-slot offset to 5 symbols.

Related Commands [[:SENSE]:ULR6_3GPP:SFRame:SEARCh]

[[:SENSe]:ULR6_3GPP:SFRame:SEARch(?)

Determines whether to detect the subframe offset automatically in the 3GPP-R6 uplink analysis.

Syntax [:SENSe]:ULR6_3GPP:SFRame:SEARch { AUTO | STSLot | DTIME }
[:SENSe]:ULR6_3GPP:SFRame:SEARch?

Arguments AUTO specifies that the subframe offset is detected automatically (default).

STSLot specifies the subframe to time-slot offset.
Set the offset using the [:SENSe]:ULR6_3GPP:SFRame:OFFSet[:STSLot] command.

DTIME specifies the downlink time offset.
Set the offset using the [:SENSe]:ULR6_3GPP:SFRame:OFFSet:DTIME command.

Measurement Modes DEMULR6_3G

Examples :SENSe:ULR6_3GPP:SFRame:SEARch AUTO
specifies that the subframe offset is detected automatically.

Related Commands [:SENSe]:ULR6_3GPP:SFRame:OFFSet:DTIME,
[:SENSe]:ULR6_3GPP:SFRame:OFFSet[:STSLot]

[[:SENSe]:ULR6_3GPP:THReshold[:BURSt](?)

Sets or queries the threshold level to detect a burst in the 3GPP-R6 uplink analysis.

Syntax [[:SENSe]:ULR6_3GPP:THReshold[:BURSt] <value>
[[:SENSe]:ULR6_3GPP:THReshold[:BURSt]?

Arguments <value>::=<NRf> specifies the threshold to detect a burst.
Range: -100 to 10 dB relative to the reference level.

Measurement Modes DEMULR6_3G

Examples :SENSe:ULR6_3GPP:THReshold:BURSt -10
sets the burst threshold to -10 dB.

[[:SENSe]:ULR6_3GPP:THReshold:DTX(?)

Sets or queries the threshold level to detect the DTX state in the 3GPP-R6 uplink analysis.

Syntax [[:SENSe]:ULR6_3GPP:THReshold:DTX <value>
[[:SENSe]:ULR6_3GPP:THReshold:DTX?

Arguments <value>::=<NRf> specifies the threshold to detect the DTX state.
Range: -20 to 0 dB relative to the DPCCH power.

Measurement Modes DEMULR6_3G

Examples :SENSe:ULR6_3GPP:THReshold:DTX -5
sets the DTX threshold to -5 dB.

[[:SENSe]:ULR6_3GPP:TOLerance(?)

Sets or queries the HS-/E-DPCCH tolerance (number of symbols which are allowed to be different from the 3GPP-R6 specifications for decoding HS-DPCCH and E-DPCCH).

Syntax [:SENSe]:ULR6_3GPP:TOLerance <value>
 [:SENSe]:ULR6_3GPP:TOLerance?

Arguments <value>::=<NRf> specifies the HS-/E-DPCCH tolerance.
 Range: 0 to 5 symbols.

Measurement Modes DEMULR6_3G

Examples :SENSe:ULR6_3GPP:TOLerance 3
 sets the tolerance to 3.

[[:SENSe]:ULR6_3GPP:UTSTable (No Query Form)

Updates the time-slot table in the main view in the 3GPP-R6 uplink analysis.

Syntax [:SENSe]:ULR6_3GPP:UTSTable

Arguments None

Measurement Modes DEMDLR6_3G

Examples :SENSe:ULR6_3GPP:UTSTable
 updates the time-slot table in the main view.

:STATus Commands

The :STATus commands control the SCPI-defined status reporting structures. In addition to those in IEEE 488.2, the analyzer has questionable and operation registers defined in SCPI. These registers conform to the IEEE 488.2 specification and each is comprised of a condition register, an event register, an enable register, and negative and positive transition filters. For details on these registers, refer to *Status and Events* beginning on page 3-1.

Command Tree

Header	Parameter
:STATus	
:OPERation	
:CONDition	
:ENABle	<bit_value>
[:EVENT]?	
:NTRansition	<bit_value>
:PTRansition	<bit_value>
:PRESet	
:QUESTionable	
:CONDition	
:ENABle	<bit_value>
[:EVENT]?	
:NTRansition	<bit_value>
:PTRansition	<bit_value>

:STATus:OPERation:CONDition? (Query Only)

Returns the contents of the Operation Condition Register (OCR).
For detail on the register, refer to Chapter 3, *Status and Events*.

Syntax :STATus:OPERation:CONDition?

Arguments None

Returns <NR1> is a decimal number showing the contents of the OCR.

Measurement Modes All

Examples :STATus:OPERation:CONDition?
might return 16, showing that the bits in the OCR have the binary value 000000000010000, which means the analyzer is in measurement.

:STATus:OPERation:ENABle(?)

Sets or queries the enable mask of the Operation Enable Register (OENR) which allows true conditions in the Operation Event Register to be reported in the summary bit. For detail on the register, refer to Chapter 3, *Status and Events*.

Syntax :STATus:OPERation:ENABle <bit_value>
:STATus:OPERation:ENABle?

Arguments <bit_value>::=<NR1> is the enable mask of the OENR. Range: 0 to 65535.

Returns <NR1> is a decimal number showing the contents of the OENR.
Range: 0 to 32767 (The most-significant bit cannot be set true.)

Measurement Modes All

Examples :STATus:OPERation:ENABle 1
enables the CALibrating bit.

:STATus:OPERation:ENABle?
might return 1, showing that the bits in the OENR have the binary value 00000000 00000001, which means that the CAL bit is valid.

:STATus:OPERation[:EVENT]? (Query Only)

Returns the contents of the Operation Event Register (OEVR). Reading the OEVR clears it. For detail on the register, refer to Chapter 3, *Status and Events*.

Syntax :STATus:OPERation[:EVENT]?

Arguments None

Returns <NR1> is a decimal number showing the contents of the OEVR.

Measurement Modes All

Examples STATus:OPERation:EVENT?
might return 1, showing that the bits in the OEVR have the binary value 00000000 00000001, which means that the CAL bit is set.

:STATus:OPERation:NTRansition(?)

Sets or queries the negative transition filter value of the Operation Transition Register (OTR). For detail on the register, refer to Chapter 3, *Status and Events*.

Syntax :STATus:OPERation:NTRansition <bit_value>
:STATus:OPERation:NTRansition?

Arguments <bit_value>::=<NR1> is the negative transition filter value. Range: 0 to 65535.

Returns <NR1> is a decimal number showing the contents of the OTR.
Range: 0 to 32767 (The most-significant bit cannot be set true.)

Measurement Modes All

Examples :STATus:OPERation:NTRansition #H120
sets the negative transition filter value to #H120.

:STATus:OPERation:NTRansition?
might return 288.

:STATus:OPERation:PTRansition(?)

Sets or queries the positive transition filter value of the Operation Transition Register (OTR). For detail on the register, refer to Chapter 3, *Status and Events*.

Syntax :STATus:OPERation:PTRansition <bit_value>
 :STATus:OPERation:PTRansition?

Arguments <bit_value>::=<NR1> is the positive transition filter value. Range: 0 to 65535.

Returns <NR1> is a decimal number showing the contents of the OTR.
 Range: 0 to 32767 (The most-significant bit cannot be set true.)

Measurement Modes All

Examples :STATus:OPERation:PTRansition 0
 sets the positive transition filter value to 0.

 :STATus:OPERation:PTRansition?
 might return 0.

:STATus:PRESet (No Query Form)

Presets SCPI enable registers OENR (Operation Enable Register) and QENR (Questionable Enable Register). For details on the registers, refer to Chapter 3, *Status and Events*.

Syntax :STATus:PRESet

Arguments None

Measurement Modes All

Examples :STATus:PRESet
 presets the registers OENR and QENR.

:STATus:QUEStionable:CONDition? (Query Only)

Returns the contents of the Questionable Condition Register (QCR).
For detail on the register, refer to Chapter 3, *Status and Events*.

NOTE. *The QCR is not used in the RSA3408A analyzer.*

Syntax :STATus:QUEStionable:CONDition?

Arguments None

Returns <NR1> is a decimal number showing the contents of the QCR.

Measurement Modes All

:STATus:QUEStionable:ENABle(?)

Sets or queries the enable mask of the Questionable Enable Register (QENR) which allows true conditions in the Questionable Event Register to be reported in the summary bit. For detail on the register, refer to Chapter 3, *Status and Events*.

NOTE. *The QENR is not used in the RSA3408A analyzer.*

Syntax :STATus:QUEStionable:ENABle <bit_value>
:STATus:QUEStionable:ENABle?

Arguments <bit_value>::=<NR1> is the enable mask of QENR. Range: 0 to 65535.

Returns <NR1> is a decimal number showing the contents of the QENR.
Range: 0 to 32767 (The most-significant bit cannot be set true.)

Measurement Modes All

:STATus:QUEStionable[:EVENT]? (Query Only)

Returns the contents of the Questionable Event Register (QEVr). Reading the QEVr clears it. For detail on the register, refer to Chapter 3, *Status and Events*.

NOTE. *The QEVr is not used in the RSA3408A analyzer.*

Syntax :STATus:QUEStionable[:EVENT]?

Arguments None

Returns <NR1> is a decimal number showing the contents of the QEVr.

Measurement Modes All

:STATus:QUEStionable:NTRansition(?)

Sets or queries the negative transition filter value of the Operation Transition Register (QTR). For detail on the register, refer to Chapter 3, *Status and Events*.

NOTE. *The QTR is not used in the RSA3408A analyzer.*

Syntax :STATus:QUEStionable:NTRansition <bit_value>
:STATus:QUEStionable:NTRansition?

Arguments <bit_value>::=<NR1> is the negative transition filter value. Range: 0 to 65535.

Returns <NR1> is a decimal number showing the contents of the QTR.
Range: 0 to 32767 (The most-significant bit cannot be set true.)

Measurement Modes All

:STATus:QUEStionable:PTRansition(?)

Sets or queries the positive transition filter value of the Questionable Transition Register (QTR). For detail on the register, refer to Chapter 3, *Status and Events*.

NOTE. *The QTR is not used in the RSA3408A analyzer.*

Syntax :STATus:QUEStionable:PTRansition <bit_value>
:STATus:QUEStionable:PTRansition?

Arguments <bit_value>::=<NR1> is the positive transition filter value. Range: 0 to 65535.

Returns <NR1> is a decimal number showing the contents of the QTR.
Range: 0 to 32767 (The most-significant bit cannot be set true.)

Measurement Modes All

:SYSTem Commands

The :SYSTem commands set up the system-related conditions.

Command Tree

Header	Parameter
:SYSTem	
:DATE	<year>, <month>, <day>
:ERRor	
:ALL?	
:CODE	
:ALL?	
[:NEXT]?	
:COUNT?	
[:NEXT]?	
:KLOCK	<boolean>
:OPTions?	
:PRESet	
:TIME	<hour>, <minute>, <second>
:VERSion?	

:SYSTem:DATE(?)

Sets or queries the date (year, month, and day). This command is equivalent to the date setting through the Windows Control Panel.

Syntax :SYSTem:DATE <year>,<month>,<day>

:SYSTem:DATE?

Arguments <year>::=<NRf> specifies the year (4 digits). Range: 2000 to 2099

<month>::=<NRf> specifies the month. Range: 1 (January) to 12 (December)

<day>::=<NRf> specifies the day. Range: 1 to 31

These values are rounded to the nearest integer.

*RST has no effect on the settings.

NOTE. This command does not support the arguments of MAXimum and MINimum.

Measurement Modes All

Examples :SYSTem:DATE 2002,3,19
sets the internal calendar to March 19, 2002.

Related Commands :SYSTem:TIME

:SYSTem:ERRor:ALL? (Query Only)

Returns all the unread information from the error/event queue, and removes all the information from the queue. For details of the error messages, refer to page 3-17.

Syntax :SYSTem:ERRor:ALL?

Arguments None

Returns <ecode>,"<edesc>[;<einfo>]"{"<ecode>,"<edesc>[;<einfo>]"} }

Where

<ecode>::=<NR1> is the error/event code (-32768 to 32767).

<edesc>::=<string> is the description on the error/event.

<einfo>::=<string> is the detail of the error/event.

Measurement Modes All

Examples :SYSTem:ERRor:ALL?
might return
-130, "Suffix error; Unrecognized suffix, INPut:MLEVel -10dB",
indicating that the unit of the reference level is improper.

:SYSTem:ERRor:CODE:ALL? (Query Only)

Returns all the unread error/event codes from the error/event queue, and removes all the information from the queue. For details of the error messages, refer to page 3-17.

Syntax :SYSTem:ERRor:CODE:ALL?

Arguments None

Returns <ecode>{,<ecode>}

Where

<ecode>::=<NR1> is the error/event code, ranging from -32768 to 32767.

Measurement Modes All

Examples :SYSTem:ERRor:CODE:ALL?
might return -101, -108 of the error codes.

:SYSTem:ERRor:CODE[:NEXT]? (Query Only)

Returns the most recent unread error/event code from the error/event queue, and removes that information from the queue. For details of the error messages, refer to page 3-17.

Syntax :SYSTem:ERRor:CODE[:NEXT]?

Arguments None

Returns <ecode>::=<NR1> is the error/event code, ranging from -32768 to 32767.

Measurement Modes All

Examples :SYSTem:ERRor:CODE:NEXT?
might return -101 of the error code.

:SYSTem:ERRor:COUNT? (Query Only)

Returns the number of unread errors/events placed in the error/event queue.

Syntax :SYSTem:ERRor:COUNT?

Arguments None

Returns <enum>::=<NR1> is the number of errors/events.

Measurement Modes All

Examples :SYSTem:ERRor:COUNT?
might return 2, indicating that the error/event queue contains two of unread errors/events.

:SYSTem:ERRor[:NEXT]? (Query Only)

Returns the next item from the error/event queue, and removes that item from the queue. For details of the error messages, refer to page 3-17.

Syntax :SYSTem:ERRor[:NEXT]?

Arguments None

Returns <ecode>,"<edesc>[;<einfo>]"

Where

<ecode>::=<NR1> is the error/event code, ranging from -32768 to 32767.

<edesc>::=<string> is the description on the error/event.

<einfo>::=<string> is the detail of the error/event.

Measurement Modes All

Examples :SYSTem:ERRor:NEXT?
might return
-130, "Suffix error; Unrecognized suffix, INPut:MLEVel -10dB",
indicating that the unit is improper.

:SYSTem:KLOCK(?)

Determines whether to lock or unlock the front panel key controls.

Syntax :SYSTem:KLOCK { OFF | ON | 0 | 1 }
:SYSTem:KLOCK?

Arguments OFF or 0 unlocks the front panel key controls.
ON or 1 locks the front panel key controls.

Measurement Modes All

Examples :SYSTem:KLOCK ON
locks the front panel key controls.

:SYSTem:OPTions? (Query Only)

Queries the options installed in the analyzer.
This command is equivalent to the IEEE common command *OPT?.

Syntax :SYSTem:OPTions?

Arguments None

Returns <option>::=<string> contains the comma-separated option numbers.

Measurement Modes All

Examples :SYSTem:OPTions?
might return "02,03,21", indicating that Option 02, 03, and 21 are currently installed in the analyzer.

Related Commands :INSTrument[:SELect]

:SYSTem:PRESet (No Query Form)

Restores the analyzer to the defaults.
This command is equivalent to the PRESET key on the front panel.

Syntax :SYSTem:PRESet

Arguments None

Measurement Modes All

Examples :SYSTem:PRESet
restores the analyzer to the defaults.

:SYSTem:TIME(?)

Sets or queries the time (hours, minutes, and seconds). This command is equivalent to the time setting through the Windows Control Panel.

Syntax :SYSTem:TIME <hour>,<minute>,<second>

:SYSTem:TIME?

Arguments <hour>::= <NRf> specifies the hours. Range: 0 to 23.

<minute>::=<NRf> specifies the minutes. Range: 0 to 59.

<second>::=<NRf> specifies the seconds. Range: 0 to 59.

These values are rounded to the nearest integer.

*RST has no effect on the settings.

NOTE. This command does not support the arguments of MAXimum and MINimum.

Measurement Modes All

Examples :SYSTem:TIME 10,15,30
sets the time to 10:15:30.

Related Commands :SYSTem:DATE

:SYSTem:VERSion? (Query Only)

Returns the SCPI version number for which the analyzer complies.

Syntax :SYSTem:VERSion?

Arguments None

Returns <NR2> has the form YYYY.V where the Ys represent the year-version (for example, 1999) and the V represents an approved revision number for that year.

Measurement Modes All

Examples :SYSTem:VERSion?
might return 1999.0 for the SCPI version.

:TRACe Commands

The :TRACe commands set up display of Trace 1 and 2.

NOTE. The :TRACe commands are available in the S/A (spectrum analysis) mode except real-time. To use a command in this group, you must have selected a S/A mode (except SARTIME and SAZRTIME) using the :INSTRument [:SElect] command.

Command Tree

Header	Parameter
:TRACe<x> :DATA<x>	
:AVERage	
:CLEar	
:COUNT	<numeric_value>
:DDETEctor	MAXimum MINimum PTPeak
:MODE	NORMal AVERage MAXHold MINHold FREeze OFF
:TRACe2 :DATA2 (Option 21 Only)	
:MODE	MAXMinimum REFerence OFF

Where

TRACe<x>::={ TRACe[1] | TRACe2 } or DATA<x>::={ DATA[1] | DATA2 }

TRACe[1] or DATA[1] indicates that this setup is made for Trace 1.

TRACe2 or DATA2 indicates that this setup is made for Trace 2.

:TRACe<x>|:DATA<x>:AVERAge:CLEAr (No Query Form)

Clears average data and counter, and restarts the average process for the specified trace.

This command is effective when you select AVERAge, MAXHold or MINHold with the :TRACe<x>|:DATA<x>:MODE command.

Syntax :TRACe<x>|:DATA<x>:AVERAge:CLEAr

Arguments None

Measurement Modes All S/A modes except SARTIME and SAZRTIME

Examples :TRACe1:AVERAge:CLEAr
clears average data and counter, and restarts the average process for Trace 1.

Related Commands :TRACe<x>|:DATA<x>:MODE

:TRACe<x>|:DATA<x>:AVERAge:COUNT(?)

Sets or queries the number of traces to combine using the :MODE setting (refer to page 2-1540).

This command is effective when you select AVERAge, MAXHold or MINHold with the :TRACe<x>|:DATA<x>:MODE command.

Syntax :TRACe<x>|:DATA<x>:AVERAge:COUNT <value>

:TRACe<x>|:DATA<x>:AVERAge:COUNT?

Arguments <value>::=<NR1> specifies the number of traces to combine for averaging.
Range: 1 to 100000 (default: 20)

Measurement Modes All S/A modes except SARTIME and SAZRTIME

Examples :TRACe1:AVERAge:COUNT 64
sets the average count to 64 for Trace 1.

Related Commands :TRACe<x>|:DATA<x>:MODE, :TRACe<x>|:DATA<x>:AVERAge:TCONtrol

:TRACe<x>|:DATA<x>:DDETECTOR(?)

Selects or queries the display detector (method to be used for decimating traces to fit the available horizontal space on screen).

The number of horizontal pixels on screen is generally smaller than that of waveform data points. When actually displayed, the waveform data is therefore thinned out, according to the number of pixels, for being compressed. For details, refer to the *RSA3408A User Manual*.

Syntax :TRACe<x>|:DATA<x>:DDETECTOR { MAXimum | MINimum | PTPeak }
:TRACe<x>|:DATA<x>:DDETECTOR?

Arguments MAXimum displays the maximum data value for each pixel.
MINimum displays the minimum data value for each pixel.
PTPeak displays the maximum and minimum data value by connecting them with a line for each pixel.

Measurement Modes All S/A modes except SARTIME and SAZRTIME

Examples :TRACe1:DDETECTOR MAXimum
displays the maximum data value for each pixel on Trace 1.

:TRACe<x>|:DATA<x>:MODE(?)

Selects or queries how to display Trace 1 and/or Trace 2.

Syntax :TRACe<x>|:DATA<x>:MODE { NORMa1 | AVERAge | MAXHo1d | MINHo1d
| FREeze | OFF }

:TRACe<x>|:DATA<x>:MODE?

Arguments NORMa1 selects an ordinary spectrum display.

AVERAge displays averaged waveform of the specified trace. The number of averages is set with the :TRACe<x>|:DATA<x>:AVERAge:COUNt command.

MAXHo1d holds the maximum level at each frequency.

MINHo1d holds the minimum level at each frequency.

FREeze stops updating the display. But the data acquisition and measurement continues.

OFF displays no trace.

Measurement Modes All S/A modes except SARTIME and SAZRTIME

Examples :TRACe1:MODE AVERAge
displays averaged waveform of Trace 1.

Related Commands :TRACe<x>|:DATA<x>:AVERAge:COUNt,
:TRACe<x>|:DATA<x>:AVERAge:TCONtrol

:TRACe2|:DATA2:MODE(?)**Option 21 Only**

Selects or queries how to display Trace 2 in the signal source analysis.

This command is valid when :INSTrument[:SElect] is set to TIMSSOURCE (signal source analysis) and [:SENSE]:SSource:MEASurement is set to PNOise (phase noise measurement).

Syntax :TRACe2|:DATA2:MODE { MAXMinimum | REFerence | OFF }
:TRACe2|:DATA2:MODE?

Arguments MAXMinimum displays the Max-Min waveform (default). For the Max-Min waveform, refer to *Trace Compression* in the *RSA3408A User Manual*.
REFerence displays the reference waveform saved for Trace 2 using the :MMEMory:STORe:TRACe1 (must be trace one).
OFF displays no Trace 2.

Measurement Modes TIMSSOURCE

Examples :TRACe2:MODE REFerence
displays the reference waveform as Trace 2.

Related Commands :INSTrument[:SElect], :MMEMory:STORe:TRACe1,
[:SENSE]:SSource:MEASurement

:TRIGger Commands

The :TRIGger commands control triggering.
For details on the trigger, refer to the *RSA3408A User Manual*.

Command Tree

Header	Parameter
:TRIGger	
[:SEQuence]	
:LEVel	
:EXTErnal	<numeric_value>
:IQFREquency	<bin_number>,<amplitude> (Option 02 only)
:IQTime	<numeric_value>
:MODE	AUTO NORMal
:MPOSITION?	<numeric_value>
:OPOSITION?	<numeric_value>
:POSITION	<numeric_value>
:SAVE	
:COUNT	
:MAXimum	<numeric_value>
[:STATe]	<boolean>
[:STATe]	<boolean>
:SLOPe	POSitive NEGative PNEGative NPOSitive
:SOURce	IQTime IQFREquency EXTErnal

:TRIGger[:SEQuence]:LEVel:EXTernal(?)

Sets or queries the trigger level when you select EXTernal using the :TRIGger[:SEQuence]:SOURce command.

Syntax :TRIGger[:SEQuence]:LEVel:EXTernal <value>
 :TRIGger[:SEQuence]:LEVel:EXTernal?

Arguments <value>::=<NR1> specifies the external trigger level.
 Range: -1.5 to +1.5 V in 0.1 V steps (default: 1.4 V)

Measurement Modes SARTIME, SAZRTIME, all Demod modes, all Time modes

Examples :TRIGger:SEQuence:LEVel:EXTernal 1.2
 sets the external trigger level to 1.2 V.

Related Commands :TRIGger[:SEQuence]:SOURce

:TRIGger[:SEQuence]:LEVel:IQFRequency(?)**Option 02 Only**

Sets or queries the trigger level when you select IQFrequency with the :TRIGger[:SEQuence]:SOURce command. The IQ frequency trigger is a triggering function that uses a trigger mask. For details of this function, refer to the *RSA3408A User Manual*.

Syntax :TRIGger[:SEQuence]:LEVel:IQFRequency <bnm>,<amp>
:TRIGger[:SEQuence]:LEVel:IQFRequency? <bnm>

Arguments <bnm>: :=<NR1> specifies the bin number of the point at which to set the trigger level (a bin is the interval between spectral samples). The valid range depends on the span as shown in Table 2-125.

Table 2-125: Bin number setting range

Span	Bin number
20 MHz or lower	0 to 800
36 MHz	0 to 720
40 MHz (baseband only)	0 to 800

<amp>: :=<NRf> specifies the trigger level relative to the reference level at bin #n. Range: -60 to 0 dB.

Measurement Modes SARTIME, SAZRTIME, all Demod modes, all Time modes

Examples The following command sequence sets the trigger mask shown by the gray rectangles in Figure 2-28:

```
:TRIGger:SEQuence:LEVel:IQFRequency 0,-10dB
:TRIGger:SEQuence:LEVel:IQFRequency 1,-10dB
...
:TRIGger:SEQuence:LEVel:IQFRequency 255,-10dB
:TRIGger:SEQuence:LEVel:IQFRequency 256,-30dB
:TRIGger:SEQuence:LEVel:IQFRequency 257,-30dB
...
:TRIGger:SEQuence:LEVel:IQFRequency 384,-30dB
:TRIGger:SEQuence:LEVel:IQFRequency 385,-10dB
:TRIGger:SEQuence:LEVel:IQFRequency 386,-10dB
...
:TRIGger:SEQuence:LEVel:IQFRequency 640,-10dB
```

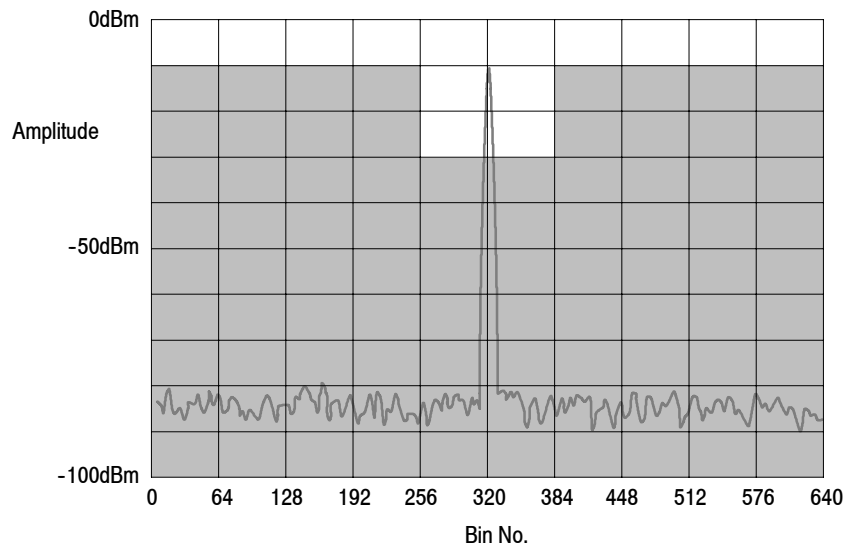

Figure 2-28: Trigger mask setting example

Related Commands :TRIGger[:SEquence]:SOURce

:TRIGger[:SEquence]:LEVel:IQTime(?)

Sets or queries the trigger level when you select IQTime with the :TRIGger[:SEquence]:SOURce command.

Syntax :TRIGger[:SEquence]:LEVel:IQTime <amp1>
:TRIGger[:SEquence]:LEVel:IQTime?

Arguments <amp1> ::= <NR1> specifies the IQ time trigger level. Range: -40 to 0 dB.

Measurement Modes SARTIME, SAZRTIME, all Demod modes, all Time modes

Examples :TRIGger:SEquence:LEVel:IQTime -10
sets the IQ time trigger level to -10 dB.

Related Commands :TRIGger[:SEquence]:SOURce

:TRIGger[:SEQuence]:MODE(?)

Selects or queries the trigger mode.

Syntax :TRIGger[:SEQuence]:MODE { AUTO | NORMa1 }
:TRIGger[:SEQuence]:MODE?

Arguments AUTO generates a trigger when the :INITiate[:IMMediate] command is sent. In the single mode, data for one waveform is acquired and displayed. In the continuous mode, data acquisition and display are repeated.

NORMa1 specifies that when the :INITiate[:IMMediate] command is sent after trigger conditions have been preset, the trigger occurs before the process stops. You can set the trigger source, slope, level, and position as the trigger conditions.

NOTE. When you select Auto for the trigger mode, you cannot set the trigger source, slope, position, and level.

At *RST, the trigger mode is set to Auto.

Measurement Modes SARTIME, SAZRTIME, all Demod modes, all Time modes

Examples :TRIGger:SEQuence:MODE AUTO
selects the auto trigger.

Related Commands :INITiate:CONTInuous, :INITiate[:IMMediate],
:TRIGger[:SEQuence]:LEVel, :TRIGger[:SEQuence]:POSition,
:TRIGger[:SEQuence]:SLOPe, :TRIGger[:SEQuence]:SOURce

:TRIGger[:SEQuence]:MPOStion? (Query Only)

Queries the trigger occurrence point in one block data acquired on the memory when measurement results are obtained with the :FETCh or :READ commands.

Syntax :TRIGger[:SEQuence]:MPOStion? <value>

Arguments <value>::=<NR1> specifies the block number. Zero indicates the latest block. Range: -2285 to 0 (standard) or -9142 to 0 (option 02)

Returns <NR1> represents the trigger occurrence point. The returned value depends on whether a trigger occurred or not, as shown in the table below.

Trigger occurrence	Returned value ¹
Trigger occurred	-1024 to (block size) × 1024 - 1
No trigger occurred	(block size) × 1024

¹ The block size is set with [:SENSe]:BSIZE.

A minus value indicates that the trigger occurred before the block data acquisition.

If you send :TRIGger[:SEQuence]:MPOStion? MINimum | MAXimum when the measurement is not performed, "Execution error" (-200) is returned.

NOTE. When you select PNEGative or NPOSitive with the :TRIGger[:SEQuence]:SLOPe command or IQFREquency with the :TRIGger[:SEQuence]:SOURce command, the returned value is the same as the :TRIGger[:SEQuence]:OPOStion? query because the analyzer cannot determine the trigger occurrence point.

Measurement Modes SARTIME, SAZRTIME, all Demod modes, all Time modes

Examples :TRIGger:SEQuence:MPOStion? -15
might return 123, indicating that the trigger occurred at the 123th data point in the block #-15.

Related Commands [:SENSe]:BSIZE, :TRIGger[:SEQuence]:OPOStion?, :TRIGger[:SEQuence]:SLOPe, :TRIGger[:SEQuence]:SOURce

:TRIGger[:SEQuence]:OPOsition? (Query Only)

Queries the trigger output point in one block data acquired when measurement results are obtained with the :FETCh or :READ commands (the trigger output point is indicated by “T” in the overview on screen).

Syntax :TRIGger[:SEQuence]:OPOsition? <value>

Arguments <value>::=<NR1> specifies the block number. Zero indicates the latest block. Range: -2285 to 0 (standard) or -9142 to 0 (option 02)

Returns <NR1> represents the trigger output point. The value depends on whether a trigger occurred or not, as shown in the table below.

Trigger occurrence	Returned value ¹
Trigger occurred	-1024 to (block size) × 1024 - 1
No trigger occurred	(block size) × 1024

¹ **The block size is set with [:SENSe]:BSIZE.**

A minus value indicates that the trigger was output before the block data acquisition.

If you send :TRIGger[:SEQuence]:OPOsition? MINimum | MAXimum when the measurement is not performed, “Execution error” (-200) is returned.

Measurement Modes SARTIME, SAZRTIME, all Demod modes, all Time modes

Examples :TRIGger:SEQuence:OPOsition? -15
might return 134, indicating that the trigger output occurs at the 134th data point in the block #-15.

Related Commands [:SENSe]:BSIZE

:TRIGger[:SEQuence]:POSition(?)

Sets or queries a trigger position.

Syntax :TRIGger[:SEQuence]:POSition <value>
 :TRIGger[:SEQuence]:POSition?

Arguments <value>::=<NRf> specifies the trigger position. Range: 0 to 100%. The trigger position is represented in percentage within a block. For example, 50% specifies that the trigger will occur at the middle frame in a block.

Measurement Modes SARTIME, SAZRTIME, all Demod modes, all Time modes

Examples :TRIGger:SEQuence:POSition 10pct
 sets the trigger position to 10%.

:TRIGger[:SEQuence]:SAVE:COUNT[:STATe](?)

Selects whether or not to set a limit on the number of times that data is saved.

Syntax :TRIGger[:SEQuence]:SAVE:COUNT[:STATe] { OFF | ON | 0 | 1 }
:TRIGger[:SEQuence]:SAVE:COUNT[:STATe]?

Arguments OFF or 0 specifies that no limit on data save operations is set. In this case, data saving is halted using the **RUN/STOP** key on the front panel or the :ABORT or :INITiate command.

ON or 1 specifies that data saving is halted when the number of data save operations reaches the limit set by the :TRIGger[:SEQuence]:SAVE:COUNT:MAXimum command.

NOTE. When the internal hard disk becomes full, data saving is halted and the “Media full” error message appears.

Measurement Modes SARTIME, SAZRTIME, all Demod modes, all Time modes

Examples :TRIGger:SEQuence:SAVE:COUNT:STATe ON
specifies that data saving is halted when the number of data save operations reaches the limit.

Related Commands :ABORT, :INITiate, :TRIGger[:SEQuence]:SAVE:COUNT:MAXimum

:TRIGger[:SEQuence]:SAVE:COUNT:MAXimum(?)

Sets or queries a limit on the number of times that data is saved when :TRIGger[:SEQuence]:SAVE:COUNT[:STATe] is set to On.

Syntax :TRIGger[:SEQuence]:SAVE:COUNT:MAXimum <value>
:TRIGger[:SEQuence]:SAVE:COUNT:MAXimum?

Arguments <value>::=<NR1> specifies a limit on the number of times that data is saved.
Range: 1 to 16383.

Measurement Modes SARTIME, SAZRTIME, all Demod modes, all Time modes

Examples :TRIGger:SEQuence:SAVE:COUNT:MAXimum 10000
sets the limit to 10000.

Related Commands :TRIGger[:SEQuence]:SAVE:COUNT[:STATe]

:TRIGger[:SEQuence]:SAVE[:STATe](?)

Determines whether to enable or disable the Save-on-Trigger function (saves one block of input data to the .IQT file each time a trigger occurs).

Syntax :TRIGger[:SEQuence]:SAVE[:STATe] { OFF | ON | 0 | 1 }
:TRIGger[:SEQuence]:SAVE[:STATe]?

Arguments OFF or 0 disables the Save-on-Trigger (default).
ON or 1 enables the Save-on-Trigger.

Measurement Modes SARTIME, SAZRTIME, all Demod modes, all Time modes

Examples :TRIGger:SEQuence:SAVE:STATe ON
enables the Save-on-Trigger function.

Related Commands :TRIGger[:SEQuence]:SAVE:COUNT[:STATe]

:TRIGger[:SEQuence]:SLOPe(?)

Selects or queries the trigger slope.

Syntax :TRIGger[:SEQuence]:SLOPe { POSitive | NEGative | PNEGative
| NPOSitive }

:TRIGger[:SEQuence]:SLOPe?

Arguments POSitive generates a trigger on the rising edge of the trigger signal.

NEGative generates a trigger on the falling edge of the trigger signal.

PNEGative specifies that the data of the first block is acquired by generating the trigger on the rising edge of the trigger signal. The data of the next block is acquired by generating the trigger on the falling edge of the trigger signal. The rising and falling edges are changed alternately each time acquisition of one-block data is completed.

NPOSitive specifies that the data of the first block is acquired by generating the trigger on the falling edge of the trigger signal. The data of the next block is acquired by generating the trigger on the rising edge of the trigger signal. The rising and falling edges are changed alternately each time acquisition of one-block data is completed.

Measurement Modes SARTIME, SAZRTIME, all Demod modes, all Time modes

Examples :TRIGger:SEQuence:SLOPe POSitive
generates a trigger on the rising edge of the trigger signal.

:TRIGger[:SEQuence]:SOURce(?)

Selects or queries the trigger source.

Syntax :TRIGger[:SEQuence]:SOURce { IQTime | IQFrequency | EXTernal }
 :TRIGger[:SEQuence]:SOURce?

Arguments IQTime generates a trigger in the time domain, using the input signal as the trigger source (default).

 IQFrequency generates a trigger in the frequency domain, using the trigger mask as the trigger source (Option 02 only).

 EXTernal defines as the trigger source, the external signal that is input through the TRIG IN connector on the rear panel. Use the :TRIGger[:SEQuence]:LEV-
 el:EXTernal command to set the trigger level.

Measurement Modes SARTIME, SAZRTIME, all Demod modes, all Time modes

Examples :TRIGger:SEQuence:SOURce EXTernal
 selects the external trigger.

Related Commands :TRIGger[:SEQuence]:LEVel:EXTernal, :TRIGger[:SEQuence]:MODE

:UNIT Commands

The :UNIT commands specify fundamental units for measurement.

Command Tree

Header	Parameter
:UNIT	
:ANGLE	DEG RAD

:UNIT:ANGLE(?)

Specifies or queries the fundamental unit of angle.

Syntax :UNIT:ANGLE { DEG | RAD }
 :UNIT:ANGLE?

Arguments DEG selects degree as the unit of angle.
 RAD selects radian as the unit of angle.

Measurement Modes All

Examples :UNIT:ANGLE RAD
 selects radian as the unit of angle.

Retrieving Response Message

When receiving a query command from the external controller, the analyzer puts the response message on the Output Queue. This message cannot be retrieved unless you perform retrieval operations through the external controller. (For example, call the IBRD subroutine included in the GPIB software of National Instruments.)

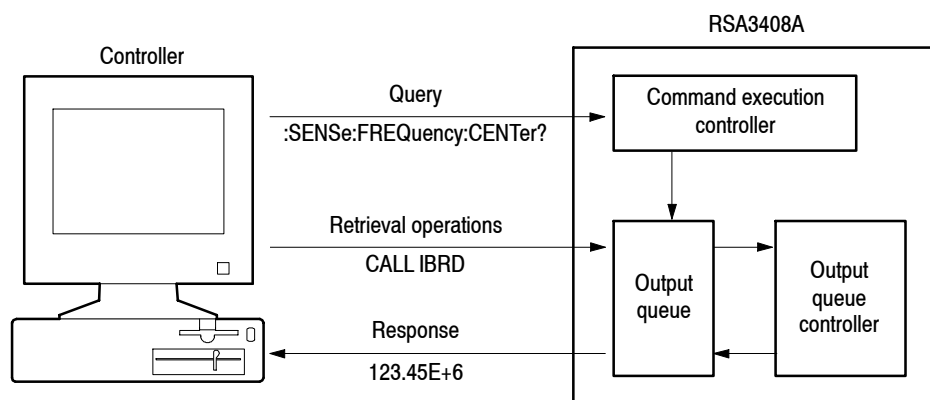

Figure 2-29: Retrieving response message

When the Output Queue contains a response message, sending another command from the external controller before retrieving this message deletes it from the queue. The Output Queue always contains the response message to the most recent query command.

You can use the MAV bit of the Status Byte Register (SBR) to check whether the Output Queue contains a response message. For details, refer to *Status Byte Register (SBR)* on page 3-6.

Status and Events

Status and Events

The SCPI interface in the analyzer includes a status and event reporting system that enables the user to monitor crucial events that occur in the instrument. The analyzer is equipped with four registers and one queue that conform to IEEE Std 488.2-1987. This section will discuss these registers and queues along with status and event processing.

Status and Event Reporting System

Figure 3-1 outlines the status and event reporting mechanism offered in the RSA3000 Series analyzers.

The status and event reporting mechanism contains three major blocks:

- Standard Event Status
- Operation Status
- Questionable Status

The processes performed in these blocks are summarized in the status bytes. They provide the error and event information.

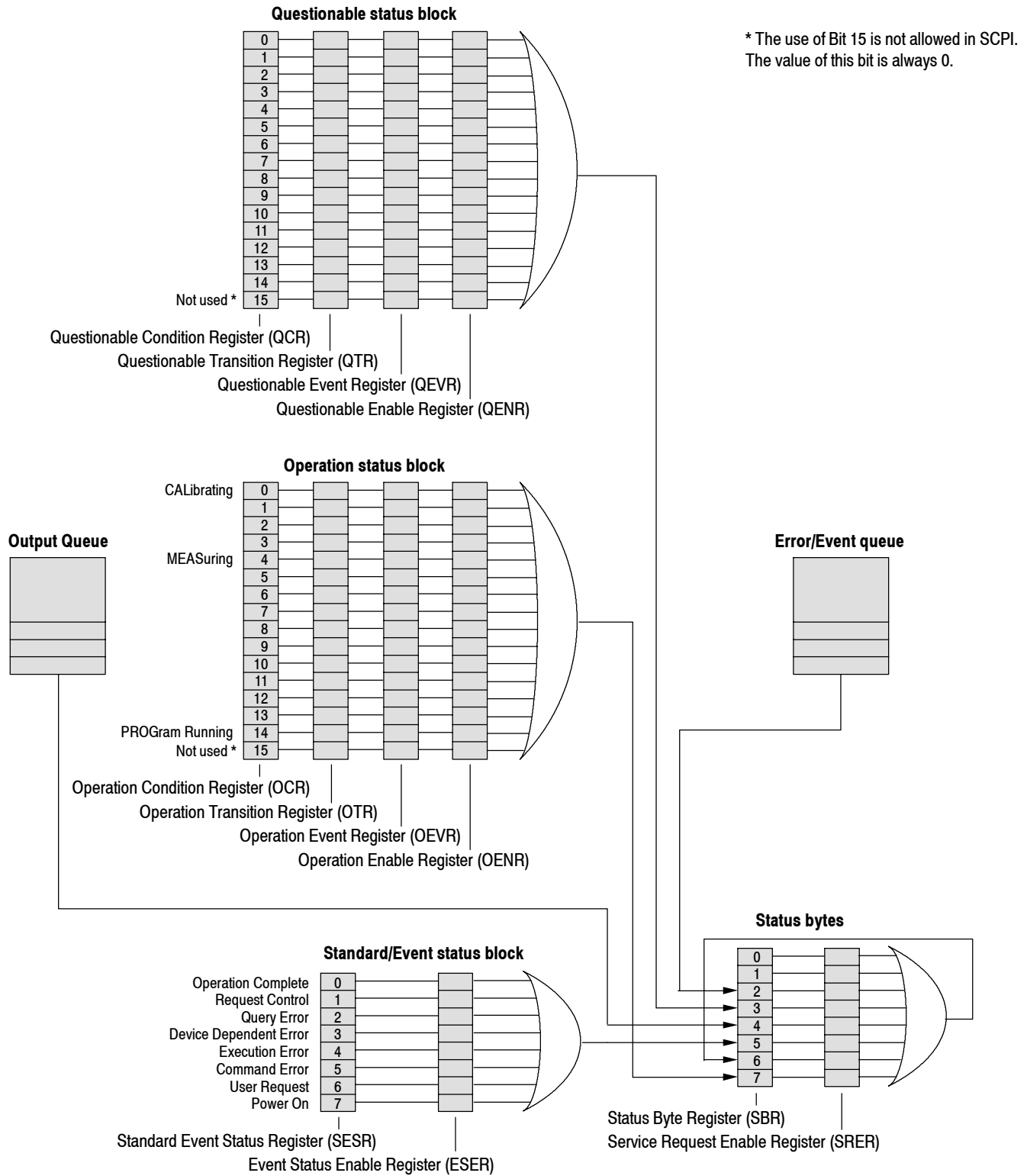

Figure 3- 1: Status/Event reporting mechanism

Standard Event Status Block

Reports the power on/off state, command errors, and the running state.

See the Standard/Event Status Block section at the bottom of Figure 3-1. This block contains two registers:

■ **Standard Event Status Register (SESR)**

Consists of eight bits. When an error or another event occurs in the analyzer, the corresponding bit of this register is set. The user cannot write any data in this register.

■ **Event Status Enable Register (ESER)**

Consists of eight bits, and masks the SESR. The mask is user-definable. By obtaining the logical product with SESR, this register can determine whether to set the Event Status Bit (ESB) of the Status Byte Register (SBR).

Processing Flow. When an event occurs, the SESR bit corresponding to the event is set, resulting in the event being stacked in the Error/Event Queue. The SBR OAV bit is also set. If the bit corresponding to the event has also been set in the ESER, the SBR ESB bit is also set.

When a message is sent to the Output Queue, the SBR MAV bit is set.

Operation Status Block

Reports the active state of the function.

See the Operation Status Block section at the middle of Figure 3-1. This block contains four registers:

- **Operation Condition Register (OCR)**
When the analyzer enters a certain state, the corresponding bit is set. The user cannot write any data in this register.
- **Operation Transition Register (OTR)**
There are two OTR types:
 - **Operation Positive Transition Register (OPTR)**
Filters when the bit corresponding to the OCR changes from False (reset) to True (set).
 - **Operation Negative Transition Register (ONTR)**
Filters when the bit corresponding to the OCR changes from True to False.
- **Operation Event Register (OEVR)**
In the OEVR, the corresponding bit is set through the OTR filter.
- **Operation Enable Register (OENR)**
Masks the OEVR. The mask is user-definable. By obtaining the logical product with SBR, this register can determine whether to set the Operation Status Bit (OSB) of the Status Byte Register (SBR).

For the contents of the bits of this register, refer to *Registers* on page 3-5.

Processing Flow. When the specified state changes in the OCR, its bit is set or reset. This change is filtered with a transition register, and the corresponding bit of the OEVR is set. If the bit corresponding to the event has also been set in the OENR, the SBR OSS bit is also set.

Questionable Status Block

Reports the states related to signals and data, for example, the signal generated by the analyzer or the precision of the data to be acquired. The register organization and the processing flow are the same as the Operation Status Block, except that the corresponding bit of the SBR is the QSB.

NOTE. *The Questionable Status Block is not used in the RSA3408A analyzer. Any of the values of the registers in this block are always 0.*

Registers

There are three main types of registers:

- **Status Registers:** stores data relating to instrument status. This register is set by the analyzer.
- **Enable Registers:** determines whether to set events that occur in the analyzer to the appropriate bit in the status registers and event queues. This type of register can be set by the user.
- **Transition Registers:** operates as a filter that examines whether an event has occurred or disappeared. This type of register can be set by the user.

Status Registers

There are six status register types:

- **Status Byte Register (SBR)**
- **Standard Event Status Register (SESR)**
- **Operation Condition Register (OCR)**
- **Operation Event Register (OEVR)**
- **Questionable Condition Register (QCR)**
- **Questionable Event Register (QEVR)**

If you need to examine the error or the state of the analyzer, read the contents of these registers.

Status Byte Register (SBR)

The SBR is made up of 8 bits. Bits 4, 5 and 6 are defined in accordance with IEEE Std 488.2-1987 (see Figure 3-2 and Table 3-1). These bits are used to monitor the output queue, SESR and service requests, respectively. The contents of this register are returned when the *STB? query is used.

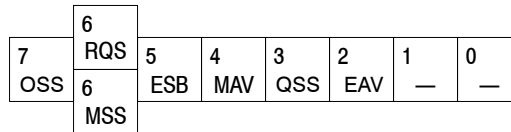

Figure 3-2: The Status Byte Register (SBR)

Table 3-1: SBR bit functions

Bit	Function
7	Operation Summary Status (OSS). Summary of the operation status register.
6	Request Service (RQS)/Master Status Summary (MSS). When the instrument is accessed using the GPIB serial poll command, this bit is called the Request Service (RQS) bit and indicates to the controller that a service request has occurred (in other words, that the GPIB bus SRQ line is LOW). The RQS bit is cleared when serial poll ends. When the instrument is accessed using the *STB? query, this bit is called the Master Status Summary (MSS) bit and indicates that the instrument has issued a service request for one or more reasons. The MSS bit is never cleared to 0 by the *STB? query.
5	Event Status Bit (ESB). This bit indicates whether or not a new event has occurred after the previous Standard Event Status Register (SESR) has been cleared or after an event readout has been performed.
4	Message Available Bit (MAV). This bit indicates that a message has been placed in the output queue and can be retrieved.
3	Questionable Summary Status (QSS). Summary of the Questionable Status Byte register. It is always zero in the RSA3408A analyzer.
2	Event Quantity Available (EAV). Summary of the Error Event Queue.
1-0	Not used

Standard Event Status Register (SESR)

The SESR is made up of 8 bits. Each bit records the occurrence of a different type of event, as shown in Figure 3-3 and Table 3-2. The contents of this register are returned when the *ESR? query is used.

7	6	5	4	3	2	1	0
PON	—	CME	EXE	DDE	QYE	—	OPC

Figure 3-3: The Standard Event Status Register (SESR)

Table 3-2: SESR bit functions

Bit	Function
7	Power On (PON). Indicates that the power to the instrument is on.
6	Not used.
5	Command Error (CME). Indicates that a command error has occurred while parsing by the command parser was in progress.
4	Execution Error (EXE). Indicates that an error occurred during the execution of a command. Execution errors occur for one of the following reasons: <ul style="list-style-type: none"> ■ When a value designated in the argument is outside the allowable range of the instrument, or is in conflict with the capabilities of the instrument ■ When the command could not be executed properly because the conditions for execution differed from those essentially required
3	Device-Dependent Error (DDE). An instrument error has been detected.
2	Query Error (QYE). Indicates that a query error has been detected by the output queue controller. Query errors occur for one of the following reasons: <ul style="list-style-type: none"> ■ An attempt was made to retrieve messages from the output queue, despite the fact that the output queue is empty or in pending status. ■ The output queue messages have been cleared despite the fact that they have not been retrieved.
1	Not used.
0	Operation Complete (OPC). This bit is set with the results of the execution of the *OPC command. It indicates that all pending operations have been completed.

Operation Condition Register (OCR)

The OCR is made up of 16 bits, which record the occurrence of three types of events, shown in Figure 3-4 and Table 3-3.

15	14 PROG	13	12	11	10	9	8	7	6	5	4 MEAS	3	2	1	0 CAL
----	------------	----	----	----	----	---	---	---	---	---	-----------	---	---	---	----------

Figure 3-4: The Operation Condition Register (OCR)

Table 3-3: OCR bit functions

Bit	Function
15	Not used.
14	Program Running Bit (PROG): Indicates whether the macro program is in execution. Set while the macro program is run by a :PROG:EXECUTE command. Reset when it ends.
13-5	Not used.
4	Measuring Bit (MEAS): Indicates whether the analyzer is in measurement. When the measurement ends after this bit is set in measurement, it is reset. “In measurement” means that one of the following commands is in execution: :INITiate commands :READ commands [:SENSe]:Standard[:IMMEDIATE] (All :IMMEDIATE commands)
3-1	Not used.
0	Calibration Bit (CAL): Indicates whether the analyzer is in measurement. When the measurement ends after this bit is set in calibration, it is reset.

Operation Event Register (OEVR)

In this instrument, this register has the same content as the Operation Condition Register (OCR), described above.

Questionable Condition Register (QCR)

The QCR is not used in the RSA3408A analyzer.

Questionable Event Register (QEVR)

The QEVR is not used in the RSA3408A analyzer.

Enable Registers

There are four enable register types:

- Event Status Enable Register (ESER)
- Service Request Enable Register (SRER)
- Operation Enable Register (OENR)
- Questionable Enable Register (QENR)

Each bit in these enable registers corresponds to a bit in the controlling status register. By setting and resetting the bits in the enable register, the user can determine whether or not events that occur will be registered to the status register and queue.

Event Status Enable Register (ESER)

The ESER is made up of bits defined exactly the same as bits 0 through 7 in the SESR (see Figure 3-5). This register is used by the user to designate whether the SBR ESB bit should be set when an event has occurred and whether the corresponding SESR bit has been set.

To set the SBR ESB bit (when the SESR bit has been set), set the ESER bit corresponding to that event. To prevent the ESB bit from being set, reset the ESER bit corresponding to that event.

Use the *ESE command to set the bits of the ESER. Use the *ESE? query to read the contents of the ESER.

7	6	5	4	3	2	1	0
PON	—	CME	EXE	DDE	QYE	—	OPC

Figure 3-5: The Event Status Enable Register (ESER)

Service Request Enable Register (SRER)

The SRER is made up of bits defined exactly the same as bits 0 through 7 in the SBR (see Figure 3-6). This register is used by the user to determine what events will generate service requests.

The SRER bit 6 cannot be set. Also, the RQS is not maskable.

The generation of a service request with the GPIB interface involves changing the SRQ line to LOW and making a service request to the controller. The result is that a status byte for which an RQS has been set is returned in response to serial polling by the controller.

Use the *SRE command to set the bits of the SRER. Use the *SRE? query to read the contents of the SRER. Bit 6 must normally be set to 0.

7	6	5	4	3	2	1	0
OSB	—	ESB	MAV	QSB	—	—	—

Figure 3-6: The Service Request Enable Register (SRER)

Operation Enable Register (OENR)

Consists of the bits that are defined as the same contents as bits 0 to 15 of the OEVR. This register is used to specify whether to set the SBR OSB bit when occurrence of an event sets the corresponding OEVR bit.

15	14	13	12	11	10	9	8	7	6	5	4	3	2	1	0
	PROG										MEAS				CAL

Figure 3-7: Operation Enable Register (OENR)

To set the contents of the OENR, use a :STATus:OPERation:ENABLE command. To query its contents, use query command STATus:OPERation:ENABLE?.

Questionable Enable Register (QENR)

The QENR is not used in the RSA3408A analyzer.

Transition Registers

There are two transition register types:

- Operation Transition Register (OTR)
- Questionable Transition Register (QTR)

Operation Transition Register (OTR)

Consists of the bits that are defined as the same contents as bits 0 to 15 of the OCR (refer to page 3-9). This bit has two functions. One is positive transition filtering, which filters when the corresponding bit of the OCR changes from False (reset) to True (set). The other is negative transition filtering, which filters when this bit changes from True to False.

To set the OTR bit to use the register as the positive transition filter, use a :STATus:OPERation:PTRansition command. To read the contents from it, use query :STATus:OPERation:PTRansition?.

To set the OTR bit to use the register as the negative transition filter, use a :STATus:OPERation:NTRansition command. To read the contents from it, use query :STATus:OPERation:NTRansition?.

15	14 PROG	13	12	11	10	9	8	7	6	5	4 MEAS	3	2	1	0 CAL
----	------------	----	----	----	----	---	---	---	---	---	-----------	---	---	---	----------

Figure 3-8: Operation Transition Register (OTR)

Questionable Transition Register (QTR)

The QTR is not used in the RSA3408A analyzer.

Queues

There are two types of queues in the status reporting system used in the analyzer: output queues and event queues.

Output Queue

The output queue is a FIFO queue and holds response messages to queries, where they await retrieval. When there are messages in the queue, the SBR MAV bit is set.

The output queue will be emptied each time a command or query is received, so the controller must read the output queue before the next command or query is issued. If this is not done, an error will occur and the output queue will be emptied; however, the operation will proceed even if an error occurs.

Event Queue

The event queue is a FIFO queue and stores events as they occur in the analyzer. If more than 32 events occur, event 32 will be replaced with event code -350 (“Queue Overflow”). The error code and text are retrieved using the :SYSTem:ERRor queries.

Status and Event Processing Sequence

Figure 3-9 shows an outline of the sequence for status and event processing.

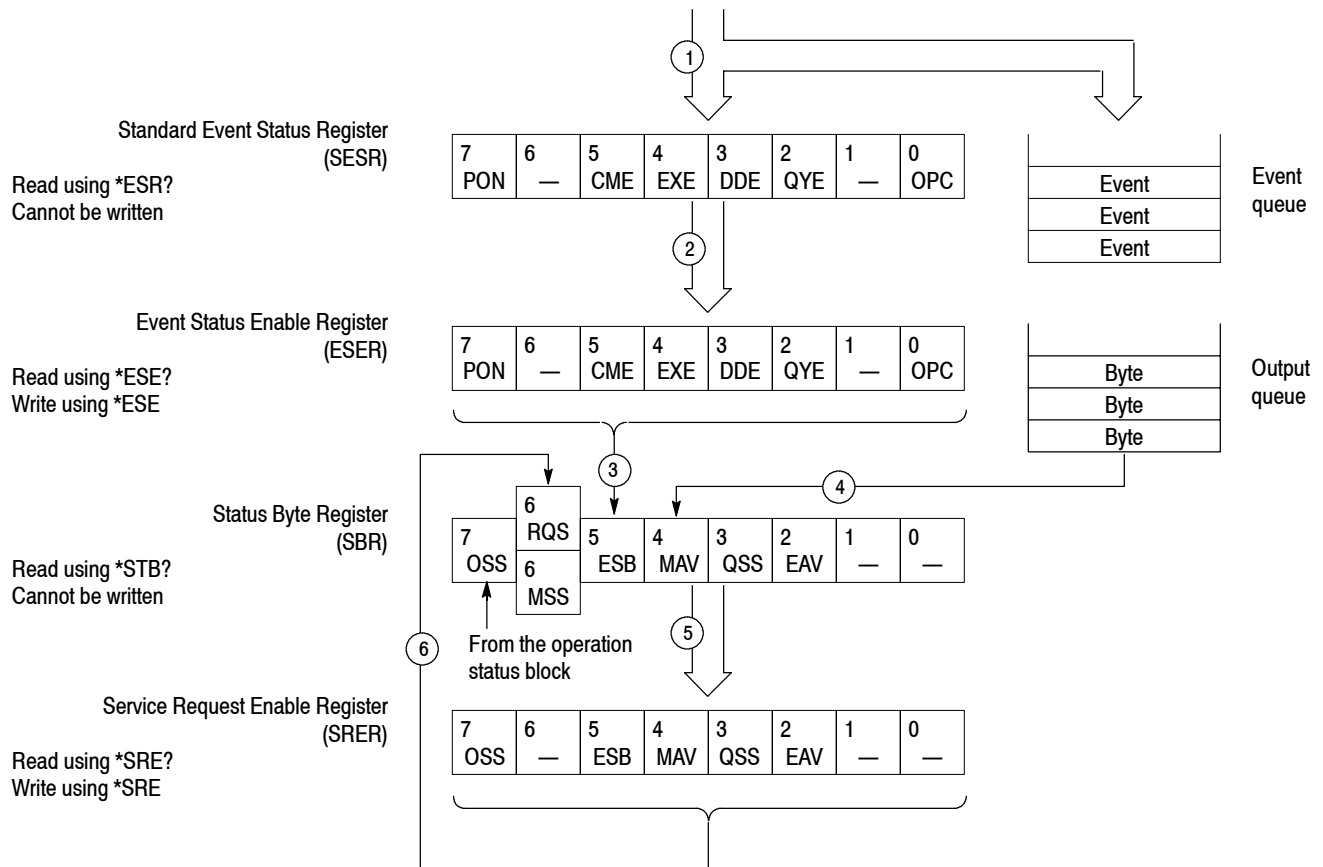

Figure 3-9: Status and event processing sequence

1. If an event has occurred, the SESR bit corresponding to that event is set and the event is placed in the event queue.
2. A bit corresponding to that event in the ESER has is set.
3. The SBR ESB bit is set to reflect the status of the ESER.
4. When a message is sent to the output queue, the SBR MAV bit is set.
5. Setting either the ESB or MAV bits in the SBR sets the respective bit in the SRER.
6. When the SRER bit is set, the SBR MSS bit is set and a service request is generated when using the GPIB interface.

Synchronizing Execution

Almost all commands are executed in the order in which they are sent from the controller, and the execution of each command is completed in a short period of time. However, the following commands perform data analysis in another thread, and another command can thus be executed concurrently:

```
:INITiate commands
:MMEMory:STORe:RESult[:SElect]
:PROGram[:SElected]:EXEcute
:PROGram[:SElected]:NAME
:READ commands
[:SENSe]:Standard[:IMMediate] (All :IMMediate commands)
[:SENSe]:ULR5_3GPP:UANResult
[:SENSe]:DLR6_3GPP|:ULR6_3GPP:UTSTable
```

These commands are designed so that the next command to be sent is executed without waiting for the previous command to be completed. In some cases, a process executed by another command must first be completed before these commands can be executed; in other cases, these commands must be completed before the next command is executed.

You have two options to achieve command synchronization:

- Using the status and event reporting function
- Using synchronizing commands

Using the Status and Event Reporting Function

In the following example, a :READ command is used to obtain the measurement results while the Operation Condition Register (OCR) is being used to provide synchronization.

```
:STATus:OPERation:NTRansition 16
// Set the filter of the OCR MEASuring bit
:STATus:OPERation:ENABLE 16
// Enable the filter of the OCR MEASuring bit
*SRE 128 // Set the SRER OSS bit
:READ:SPECTrum? // Obtain the measurement results
```

The command waits for generation of SRQ.

Using Synchronizing Commands

The IEEE-488.2 common commands include the following synchronizing commands:

```
*OPC
*OPC?
*WAI
```

Using the *OPC Command. The *OPC command sets the SESR OPC bit when all the operations for which it is waiting are completed. If the GPIB interface is in use, you can synchronize the execution by using this command together with the serial polling or service request function.

The following is a command sequence example:

```
*ESE 1      // Enable the ESER OPC bit
*SRE 32     // Enable the SRER ESB bit
:ABORt;INITiate:IMMediate;*OPC
           // Wait for SRQ to provide synchronization
```

Using the Query *OPC? The query *OPC? writes ASCII code “1” into the Output Queue when all operations for which it is waiting are completed. You can provide synchronization using the command string as the following example:

```
:ABORt;INITiate:IMMediate;*OPC?
```

The command waits until “1” is written into the Output Queue. When the command goes to the Output Queue to read the data, a time-out may occur before the data is written into the queue.

Using the *WAI Command. After the process of the preceding command is completed, the *WAI command begins to execute the process of the next command as the following example:

```
:ABORt;INITiate:IMMediate;*WAI
           // Wait for the *WAI process to provide
synchronization
```

Error Messages and Codes

Tables 3-4 through 3-7 show the SCPI standard error codes and messages used in the status and event reporting system in the analyzer.

Event codes and messages can be obtained by using the queries :SYSTem:ERRor. These are returned in the following format:

<event code>,"<event message>"

Command Errors

Command errors are returned when there is a syntax error in the command.

Table 3-4: Command errors

Error code	Error message
-100	command error
-101	invalid character
-102	syntax error
-103	invalid separator
-104	data type error
-105	GET not allowed
-108	parameter not allowed
-109	missing parameter
-110	command header error
-111	header separator error
-112	program mnemonic too long
-113	undefined header
-114	header suffix out of range
-120	numeric data error
-121	character
-123	exponent too large
-124	too many digits
-128	numeric data not allowed
-130	suffix error
-131	invalid suffix
-134	suffix too long
-138	suffix not allowed
-140	character data error
-141	invalid character data
-144	character data too long
-148	character data not allowed
-150	string data error
-151	invalid string data
-158	string data not allowed

Table 3-4: Command errors (Cont.)

Error code	Error message
-160	block data error
-161	invalid block data
-168	block data not allowed
-170	command expression error
-171	invalid expression
-178	expression data not allowed
-180	macro error
-181	invalid outside macro definition
-183	invalid inside macro definition
-184	macro parameter error

Execution Errors

These error codes are returned when an error is detected while a command is being executed.

Table 3-5: Execution errors

Error code	Error message
-200	execution error
-201	invalid while in local
-202	settings lost due to RTL
-210	trigger error
-211	trigger ignored
-212	arm ignored
-213	init ignored
-214	trigger deadlock
-215	arm deadlock
-220	parameter error
-221	settings conflict
-222	data out of range
-223	too much data
-224	illegal parameter value
-225	out of memory
-226	lists not same length
-230	data corrupt or stale
-231	data questionable
-240	hardware error
-241	hardware missing
-250	mass storage error
-251	missing mass storage
-252	missing media
-253	corrupt media
-254	media full
-255	directory full
-256	FileName not found
-257	FileName error
-258	media protected

Table 3-5: Execution errors (Cont.)

Error code	Error message
-260	execution expression error
-261	math error in expression
-270	execution macro error
-271	macro syntax error
-272	macro execution error
-273	illegal macro label
-274	execution macro parameter error
-275	macro definition too long
-276	macro recursion error
-277	macro redefinition not allowed
-278	macro header not found
-280	program error
-281	cannot create program
-282	illegal program name
-283	illegal variable name
-284	program currently running
-285	program syntax error
-286	program runtime error

Device Specific Errors

These error codes are returned when an internal instrument error is detected. This type of error may indicate a hardware problem.

Table 3-6: Device specific errors

Error code	Error message
-300	device specific error
-310	system error
-311	memory error
-312	PUD memory lost
-313	calibration memory lost
-314	save/recall memory lost
-315	configuration memory lost
-330	self test failed
-350	queue overflow

Query Errors

These error codes are returned in response to an unanswered query.

Table 3-7: Query errors

Error code	Error message
-400	query error
-410	query interrupted
-420	query untermiated
-430	query deadlocked
-440	query untermiated after indefinite period

Programming Examples

Programming Examples

This section provides the general programming procedure and then shows an application program sample that controls the analyzer through the GPIB and a macro program execution sample that uses :PROGram commands.

- General programming procedure
- Application program sample
- Macro program execution sample

General Programming Procedure

You should generally use the following procedure to script a program:

1. *Setting the measurement mode*

Using an :INSTRument command, select a measurement mode to set the basic conditions.

[Example] :INSTRument:SElect "SANORMAL"

Selects the normal spectrum analysis mode to set the basic conditions.

2. *Setting the measurement item*

Using a :CONFIgure command, select a measurement item to set up the analyzer to the defaults.

[Example] :CONFIgure:SPECTrum:CHPower

Sets up the analyzer to the channel power measurement defaults.

3. *Detailed settings*

Use :SENSE commands to set details for the measurement session.

[Example] :SENSE:CHPower:BWIDth:INTEgration 3MHz

Sets the channel power measurement range to 3 MHz.

4. *Acquiring data*

Use an :INITiate or :ABORt command to initiate or stop data acquisition.

[Example] :INITiate:CONTinuous ON

Initiates data acquisition in continuous mode.

To save or load the acquired data and settings, use an :MMEMory command.

[Example] :MMEMory:STORe:IQT "DATA1"

Saves the acquired data in file DATA1.IQT.

5. *Obtaining the measurement results*

Use a :FETCh or :READ command to obtain the measurement results.

[Example] :FETCh:SPECTrum:CHPower?

Returns the channel power measurement results.

6. *Display*

Use :DISPlay commands to set the display-related conditions.

[Example] :DISPlay:SPECTrum:X:SCALE:OFFSet 800MHz

Sets 800 MHz for the minimum (left) edge of the horizontal axis in the spectrum view.

NOTE. A menu item grays out on the screen when the setting is prohibited or unavailable. If you run the GPIB command corresponding to this menu item, an execution error occurs. For example, when no waveform is displayed on the screen, the scale-related commands are invalid.

Appendix C lists the default settings of the commands.

Application Program Sample

This section shows an application program sample that performs two measurements:

- **Channel power measurement (measCHPOWER() subroutine)**
In the S/A (spectrum analysis) mode, the *OPC command is used to provide synchronization while channel power measurement is being performed. Then, the measured data is saved in a file.
- **FM signal measurement (measFM() subroutine)**
In the Demod (modulation analysis) mode, the status byte MAV bit is used to provide synchronization while the FM vector signal measurement is being performed. Then, the measured data is saved in a file.

This program has been scripted for use in Microsoft Visual C++ 6.0. It operates with an IBM PC-compatible system equipped with National Instruments GPIB board and driver software (operation capabilities confirmed with Windows 98 and National Instruments GPIB board PCI-GPIB). To enable this program, the analyzer must have been set to DEV1 by using wibconf or other means.

```
//
// Sample program
//
// Channel power measurement & FM signal measurement
//
#include <windows.h>
#include <stdio.h>
#include <string.h>

#include "decl-32.h"

#define LONG_TIME T100s
#define NORMAL_TIME T10s

#define BOARD_NAME "GPIB0"
#define MAX_BUF (1024)

// Bit definition of SBR (Status Byte Register)
#define ESB (1<<5) // ESB (Event Status Bit)
#define MAV (1<<4) // MAV (Message Available)
#define EAV (1<<2) // EAV (Event Queue Available)
```

```

char readBuf[MAX_BUF + 1];
char openDevice [MAX_BUF/2 + 1];

void GpibClose(void);
void GpibError(char *errorMessage);
void GpibExit(int code);
void GpibOpen(char *device);
void GpibRead(char *resp, int count);
void GpibReadFile(char *filename);
int  GpibSerialPoll(void);
void GpibTimeOut(int timeout);
void GpibWait(int wait);
void GpibWrite(char *string);
void measCHPOWER(void);
void measFM(void);
void WaitOPC(void);
void WaitMAV(void);

int GpibDevice;           // Device descriptor
int GpibBoard;           // GPIB board descriptor
int GpibCount;           // Store ibcnt
int GpibStatus;         // Store ibsta

// Main routine
void
main(int argc, char *argv[])
{
    strcpy(openDevice, "dev1");

    GpibOpen(openDevice); // Detect the specified device

    measCHPOWER();       // Channel power measurement

    measFM();            // FM signal measurement

    GpibClose();        // Terminate the device and board
}

```



```
// Channel power measurement
void
measCHPOWER(void)
{
    GpibWrite("*CLS"); // Clear the status register
    GpibWrite("*ESE 1"); // Set the OPC bit of ESER
    GpibWrite("*SRE 32"); // Set the ESB bit of SRER

    // Set up the analyzer
    GpibTimeOut(LONG_TIME);
    GpibWrite("INSTRUMENT 'SANORMAL'");
    GpibWrite("*RST"); // Reset the analyzer
    GpibTimeOut(NORMAL_TIME);
    GpibWrite("CONFIGURE:SPECTRUM:CHPOWER");
    GpibWrite("FREQUENCY:CENTER 1GHZ");
    GpibWrite("FREQUENCY:SPAN 1MHZ");
    GpibTimeOut(LONG_TIME);
    GpibWrite("*CAL?");
    GpibRead(readBuf, MAX_BUF);
    printf("*CAL? result = %s\n", readBuf);
    GpibTimeOut(NORMAL_TIME);
    GpibWrite("CHPOWER:BANDWIDTH:INTEGRATION 300KHZ");
    GpibWrite("SPECTRUM:AVERAGE ON");
    GpibWrite("SPECTRUM:AVERAGE:COUNT 100");

    // Perform the measurement
    GpibTimeOut(LONG_TIME);
    GpibWrite("INITIATE:CONTINUOUS OFF;*OPC");
    WaitOPC(); // Wait for the OPC bit set
    GpibWrite("INITIATE;*OPC");
    WaitOPC();
    GpibTimeOut(NORMAL_TIME);

    // Get measurement results and save them to the file chpower
    GpibWrite("FETCH:SPECTRUM:CHPOWER?");
    GpibReadFile("chpower");
}
```

```

// FM signal measurement
void
measFM(void)
{
    // Set up the analyzer
    GpibTimeout(LONG_TIME);
    GpibWrite("INSTRument 'DEMADEM'");
    GpibWrite("*RST"); // Reset the analyzer
    GpibTimeout(NORMAL_TIME);
    GpibWrite("CONFigure:ADEMod:FM");
    GpibWrite("FREQuency:CENTer 1GHz");
    GpibWrite("FREQuency:SPAN 1MHz");
    GpibWrite("BSIZE 100");
    GpibTimeout(LONG_TIME);
    GpibWrite("*CAL?");
    GpibRead(readBuf, MAX_BUF);
    printf("*CAL? result = %s\n", readBuf);
    GpibTimeout(NORMAL_TIME);
    GpibWrite("ADEMod:LENGth 102400");
    GpibWrite("ADEMod:FM:THReshold -100");

    GpibWrite("*CLS"); // Clear the status register
    GpibWrite("*SRE 16"); // Set the MAV bit of SRER

    // Perform the measurement
    GpibTimeout(LONG_TIME);
    GpibWrite("READ:ADEMod:FM?");
    WaitMAV(); // Wait for the MAV bit set
    GpibTimeout(NORMAL_TIME);

    // Get measurement results and save them to the file fm
    GpibReadFile("fm");
}

```

```
// Wait for the OPC (Operation complete) bit set
void
WaitOPC(void)
{
    int statusByte;

    // Wait for SRQ
    GpibWait(RQS);
    if (GpibStatus & TIMO)
    {
        fprintf(stderr, "Timeout occurred in waiting
            SRQ cycle.\n");
        GpibExit(0);
    }

    // Serial poll
    statusByte = GpibSerialPoll();
    if (statusByte & ESB)
    {
        printf("ESB bit is TRUE\n");
        GpibWrite("*ESR?");
        GpibRead(readBuf, MAX_BUF);
        printf("Standard Event Status Register = %s\n", readBuf);
    }
    if (statusByte & MAV)
        printf("MAV bit is TRUE\n");
    if (statusByte & EAV)
        printf("EAV bit is TRUE\n");
}
```

```
// Wait for the MAV (Message Available) bit set
void
WaitMAV(void)
{
    int statusByte;

    // Wait for SRQ
    GpibWait(RQS);
    if (GpibStatus & TIMO)
    {
        fprintf(stderr, "Timeout occurred in waiting SRQ
            cycle.\n");
        GpibExit(0);
    }

    // Serial poll
    statusByte = GpibSerialPoll();
    if (statusByte & MAV)
        printf("MAV bit is TRUE\n");
    if (statusByte & EAV)
        printf("EAV bit is TRUE\n");
}
```

```
// Open the GPIB device
void
GpibOpen(char *device)
{
    // Assign ID to the device and interface board,
    // and check on error.
    GpibDevice = ibfind(device);
    if (ibsta & ERR)
    {
        GpibError("ibfind Error: Unable to find device");
        GpibExit(0);
    }
    GpibBoard = ibfind(BOARD_NAME);
    if (ibsta & ERR)
    {
        GpibError("ibfind Error: Unable to find board");
        GpibExit(0);
    }

    // Clear the device and check on error.
    ibclr(GpibDevice);
    if (ibsta & ERR)
    {
        GpibError("ibclr Error: Unable to clear device");
        GpibExit(0);
    }
    ibsre(GpibBoard, 0);
    if (ibsta & ERR)
    {
        GpibError("ibclr Error: Unable to clear board");
        GpibExit(0);
    }

    // Set the timeout to 10 seconds (NORMAL_TIME)
    GpibTimeOut(NORMAL_TIME);
}

// Close the GPIB device
void
GpibClose(void)
{
    // Turn off the device and interface board
    ibonl(GpibDevice, 0);
    ibonl(GpibBoard, 0);
}
```

```

// End the program
void
GpibExit(int code)
{
    GpibClose();
    exit(code);
}

// Send string to the device and wait for the completion
void
GpibWrite(char *string)
{
    int count = strlen(string);

    // Send the string
    ibwrt(GpibDevice, string, count);

    // Determine the I/O completion of ibwrt
    if (ibsta & ERR)
    {
        GpibError("ibwrt I/O Error:");
        GpibExit(0);
    }
    else
    {
        GpibCount = ibcnt;
        GpibStatus = ibsta;
        if (GpibSerialPoll() & EAV)
        {
            ibwrt(GpibDevice, "SYSTem:ERRor:ALL?",
                strlen("SYSTem:ERRor:ALL?"));
            ibrd(GpibDevice, readBuf, MAX_BUF);
            fprintf(stderr, "%s\n", readBuf);
        }
    }
}

```

```
// Read response from the device
void
GpibRead(char *resp, int count)
{
    ibrd(GpibDevice, resp, count);

    if (ibsta & ERR)
    {
        GpibError("ibrd I/O Error:");
        GpibExit(0);
    }
    else
    {
        resp[ibcnt] = '\0';
        GpibCount = ibcnt;
        GpibStatus = ibsta;
    }
}

// Read response from the device and write it to a file
void
GpibReadFile(char *filename)
{
    ibrdf(GpibDevice, filename);

    if (ibsta & ERR)
    {
        GpibError("ibrdf I/O Error:");
        GpibExit(0);
    }
    else
    {
        GpibStatus = ibsta;
    }
}
```

```
// Read the status byte
int
GpibSerialPoll(void)
{
    char poll = 0;

    ibrsp(GpibDevice, &poll);
    if (ibsta & ERR)
    {
        GpibError("ibrsp Error:");
        GpibExit(0);
    }
    else
    {
        GpibStatus = ibsta;
    }

    return poll & 0xff;
}

// Set timeout
void
GpibTimeOut(int timeout)
{
    ibtmo(GpibDevice, timeout);
    if (ibsta & ERR)
    {
        GpibError("ibtmo Error:");
        GpibExit(0);
    }
    else
    {
        GpibStatus = ibsta;
    }
}
```



```
// Wait for the specified event
void
GpibWait(int wait)
{
    ibwait(GpibDevice, wait | TIMO);
    if (ibsta & (ERR | TIMO))
    {
        GpibError("ibwait Error:");
    }
    GpibStatus = ibsta;
}

// Display error message by ibsta
void
GpibError(char *errorMessage)
{
    fprintf (stderr, "%s\n", errorMessage);
    fprintf (stderr, "ibsta=(%X)h <", ibsta);

    if (ibsta & ERR ) fprintf (stderr, " ERR");
    if (ibsta & TIMO) fprintf (stderr, " TIMO");
    if (ibsta & END ) fprintf (stderr, " END");
    if (ibsta & SRQI) fprintf (stderr, " SRQI");
    if (ibsta & RQS ) fprintf (stderr, " RQS");
    if (ibsta & CMPL) fprintf (stderr, " CMPL");
    if (ibsta & LOK ) fprintf (stderr, " LOK");
    if (ibsta & REM ) fprintf (stderr, " REM");
    if (ibsta & CIC ) fprintf (stderr, " CIC");
    if (ibsta & ATN ) fprintf (stderr, " ATN");
    if (ibsta & TACS) fprintf (stderr, " TACS");
    if (ibsta & LACS) fprintf (stderr, " LACS");
    if (ibsta & DTAS) fprintf (stderr, " DTAS");
    if (ibsta & DCAS) fprintf (stderr, " DCAS");

    fprintf (stderr, " >\n");
    fprintf (stderr, "iberr= %d", iberr);
}
```

```

if (iberr == EDVR) fprintf (stderr,
    " EDVR <DOS Error>\n");
if (iberr == ECIC) fprintf (stderr,
    " ECIC <Not CIC>\n");
if (iberr == ENOL) fprintf (stderr,
    " ENOL <No Listener>\n");
if (iberr == EADR) fprintf (stderr,
    " EADR <Address error>\n");
if (iberr == EARG) fprintf (stderr,
    " EARG <Invalid argument>\n");
if (iberr == ESAC) fprintf (stderr,
    " ESAC <Not Sys Ctrlr>\n");
if (iberr == EABO) fprintf (stderr,
    " EABO <Op. aborted>\n");
if (iberr == ENEB) fprintf (stderr,
    " ENEB <No GPIB board>\n");
if (iberr == EOIP) fprintf (stderr,
    " EOIP <Async I/O in prg>\n");
if (iberr == ECAP) fprintf (stderr,
    " ECAP <No capability>\n");
if (iberr == EFSO) fprintf (stderr,
    " EFSO <File sys. error>\n");
if (iberr == EBUS) fprintf (stderr,
    " EBUS <Command error>\n");
if (iberr == ESTB) fprintf (stderr,
    " ESTB <Status byte lost>\n");
if (iberr == ESRQ) fprintf (stderr,
    " ESRQ <SRQ stuck on>\n");
}

```

Macro Program Execution Sample

This section shows a macro program execution sample. The macro programs are installed under the following directories in the analyzer:

- Macros specific to a user:
`C:\Program Files\Tektronix\wca200a\Python\wca200a\measmacro\nonregistered`
- Macros included in a option:
`C:\Program Files\Tektronix\wca200a\Python\wca200a\measmacro\registered`

In the example below, the following macro folders are placed in these directories:

MacroTest1, MacroTest2, and MacroTest3 under the *nonregistered* directory
 MacroTest1, MacroTest4, and MacroTest5 under the *registered* directory

The MacroTest1 macro folder contains macro commands test1, test2, and test3.

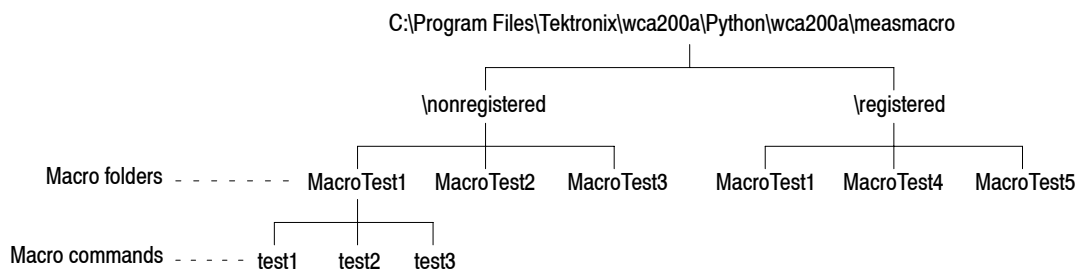

Figure 4-1: Saving the macro programs

Suppose that the following variables have been defined in the macro command test1:

LOW_LIMIT, HIGH_LIMIT (numeric parameters)
 ERROR_MESSAGE (character string parameter)
 RESULT (measurement results (numeric values))

The following is an example of sending and responding commands:

```
[Send]      PROG:CAT?    // Query the list of the macro program
[Response]  "NONREGISTERED.MACROTEST1",
            "NONREGISTERED.MACROTEST2",
            "NONREGISTERED.MACROTEST3",
            "REGISTERED.MACROTEST1",
            "REGISTERED.MACROTEST4",
            "REGISTERED.MACROTEST5"

[Send]      PROG:NAME "NONREGISTERED.MACROTEST1"
            // Specify the macro program
[Send]      PROG:NUMB "LOW_LIMIT",1.5 // Set LOW_LIMIT to 1.5
[Send]      PROG:NUMB "HIGH_LIMIT",20 // Set HIGH_LIMIT to 20
[Send]      PROG:STR "ERROR_MESSAGE","Unsuccessful"
            // Set ERROR_MESSAGE
[Send]      PROG:EXEC "TEST1" // Run the macro command
[Send]      PROG:NUMB? "RESULT" // Retrieve the results
[Response]  1.2345
[Send]      PROG:DEL // Delete the macro program from memory
```

Appendices



Appendix A: Character Charts

The ASCII and GPIB code chart is shown in Table A-1 on page A-2.

Table A-1: ASCII & GPIB code chart

B7 B6 BITS B4 B3 B2 B1	0 0 0		0 0 1		0 1 0		0 1 1		1 0 0		1 0 1		1 1 0		1 1 1	
	CONTROL				NUMBERS SYMBOLS				UPPER CASE				LOWER CASE			
0 0 0 0	0 0	NUL 0	20 10	DLE 16	40 20	SP 32	60 30	0 48	100 40	@ 64	120 50	P 80	140 60	' 96	160 70	p 112
0 0 0 1	1 1	GTL SOH 1	21 11	LL0 DC1 17	41 21	LA1 ! 33	61 31	LA17 1 49	101 41	TA1 A 65	121 51	TA17 Q 81	141 61	SA1 a 97	161 71	SA17 q 113
0 0 1 0	2 2	STX 2	22 12	DC2 18	42 22	LA2 " 34	62 32	LA18 2 50	102 42	TA2 B 66	122 52	TA18 R 82	142 62	SA2 b 98	162 72	SA18 r 114
0 0 1 1	3 3	ETX 3	23 13	DC3 19	43 23	LA3 # 35	63 33	LA19 3 51	103 43	TA3 C 67	123 53	TA19 S 83	143 63	SA3 c 99	163 73	SA19 s 115
0 1 0 0	4 4	SDC EOT 4	24 14	DCL DC4 20	44 24	LA4 \$ 36	64 34	LA20 4 52	104 44	TA4 D 68	124 54	TA20 T 84	144 64	SA4 d 100	164 74	SA20 t 116
0 1 0 1	5 5	PPC ENQ 5	25 15	PPU NAK 21	45 25	LA5 % 37	65 35	LA21 5 53	105 45	TA5 E 69	125 55	TA21 U 85	145 65	SA5 e 101	165 75	SA21 u 117
0 1 1 0	6 6	ACK 6	26 16	SYN 22	46 26	LA6 & 38	66 36	LA22 6 54	106 46	TA6 F 70	126 56	TA22 V 86	146 66	SA6 f 102	166 76	SA22 v 118
0 1 1 1	7 7	BEL 7	27 17	ETB 23	47 27	LA7 , 39	67 37	LA23 7 55	107 47	TA7 G 71	127 57	TA23 W 87	147 67	SA7 g 103	167 77	SA23 w 119
1 0 0 0	8 8	GET BS 8	30 18	SPE CAN 24	50 28	LA8 (40	70 38	LA24 8 56	110 48	TA8 H 72	130 58	TA24 X 88	150 68	SA8 h 104	170 78	SA24 x 120
1 0 0 1	9 9	TCT HT 9	31 19	SPD EM 25	51 29	LA9) 41	71 39	LA25 9 57	111 49	TA9 I 73	131 59	TA25 Y 89	151 69	SA9 i 105	171 79	SA25 y 121
1 0 1 0	A A	LF 10	32 1A	SUB 26	52 2A	LA10 * 42	72 3A	LA26 : 58	112 4A	TA10 J 74	132 5A	TA26 Z 90	152 6A	SA10 j 106	172 7A	SA26 z 122
1 0 1 1	B B	VT 11	33 1B	ESC 27	53 2B	LA11 + 43	73 3B	LA27 ; 59	113 4B	TA11 K 75	133 5B	TA27 [91	153 6B	SA11 k 107	173 7B	SA27 { 123
1 1 0 0	C C	FF 12	34 1C	FS 28	54 2C	LA12 , 44	74 3C	LA28 < 60	114 4C	TA12 L 76	134 5C	TA28 \ 92	154 6C	SA12 l 108	174 7C	SA28 124
1 1 0 1	D D	CR 13	35 1D	GS 29	55 2D	LA13 - 45	75 3D	LA29 = 61	115 4D	TA13 M 77	135 5D	TA29] 93	155 6D	SA13 m 109	175 7D	SA29 } 125
1 1 1 0	E E	SO 14	36 1E	RS 30	56 2E	LA14 . 46	76 3E	LA30 > 62	116 4E	TA14 N 78	136 5E	TA30 ^ 94	156 6E	SA14 n 110	176 7E	SA30 ~ 126
1 1 1 1	F F	SI 15	37 1F	US 31	57 2F	LA15 / 47	77 3F	UNL ? 63	117 4F	TA15 O 79	137 5F	UNT - 95	157 6F	SA15 o 111	177 7F	RUBOUT (DEL) 127
		ADDRESSED COMMANDS		UNIVERSAL COMMANDS		LISTEN ADDRESSES		TALK ADDRESSES		SECONDARY ADDRESSES OR COMMANDS						

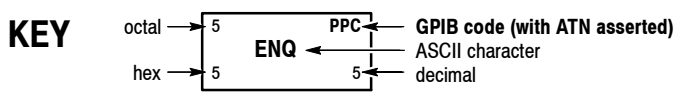

Tektronix
 REF: ANSI STD X3.4-1977
 IEEE STD 488.1-1987
 ISO STD 646-2973

Appendix B: GPIB Interface Specification

This appendix lists and describes the GPIB functions and messages the waveform generator implements.

Interface Functions

Table B-1 lists the GPIB interface functions this instrument implements. Each function is briefly described on page B-2.

Table B- 1: GPIB interface function implementation

Interface function	Implemented subset	Capability
Source Handshake (SH)	SH1	Complete
Acceptor Handshake (AH)	AH1	Complete
Talker (T)	T6	Basic Talker, Serial Poll Unaddress if my-listen-address (MLA) No Talk Only mode
Listener (L)	L4	Basic Listener Unaddress if my talk address (MTA) No Listen Only mode
Service Request (SR)	SR1	Complete
Remote/Local (RL)	RL0	None
Parallel Poll (PP)	PP0	None
Device Clear (DC)	DC1	Complete
Device Trigger (DT)	DT0	None
Controller (C)	C0	None
Electrical Interface	E2	Three-state driver

- **Source Handshake (SH).** Enables a talking device to support the coordination of data transfer. The SH function controls the initiation and termination of data byte transfers.
- **Acceptor Handshake (AH).** Enables a listening device to coordinate data reception. The AH function delays data transfer initiation or termination until the listening device is ready to receive the next data byte.
- **Talker (T).** Enables a device to send device-dependent data over the interface. This capability is available only when the device is addressed to talk, and uses a one-byte address.
- **Listener (L).** Enables a device to receive device-dependent data over the interface. This capability is available only when the device is addressed to listen, and uses a one-byte address.
- **Service Request (SR).** Enables a device to assert an SRQ (Service Request) line to notify the controller when it requires service.
- **Remote/Local (RL).** Enables a device to respond to both the GTL (Go To Local) and LLO (Local Lock Out) interface messages.
- **Parallel Poll (PP).** Enables a device to respond to the following interface messages: PPC, PPD, PPE, and PPU, as well as to send out a status message when the ATN (Attention) and EOI (End or Identify) lines are asserted simultaneously.
- **Device Clear (DC).** Enables a device to be cleared or initialized, either individually, or as part of a group of devices.
- **Device Trigger (DT).** Enables a device to respond to the GET (Group Execute Trigger) interface message when acting as a listener.
- **Controller (C).** Enables a device that has this capability to send its address, universal commands, and addressed commands to other devices over the interface.
- **Electrical Interface (E).** Identifies the electrical interface driver type. The notation E1 means the electrical interface uses open collector drivers, E2 means the electrical interface uses three-state drivers.

Interface Messages

Table B-2 shows the standard interface messages that are supported by the analyzer.

Table B-2: Standard interface messages

Message	Type	Implemented
Device Clear (DCL)	UC	Yes
Local Lockout (LLO)	UC	No
Serial Poll Disable (SPD)	UC	Yes
Serial Poll Enable (SPE)	UC	Yes
Parallel Poll Unconfigure (PPU)	UC	No
Go To Local (GTL)	AC	Yes
Selected Device Clear (SDC)	AC	Yes
Group Execute Trigger (GET)	AC	No
Take Control (TCT)	AC	No
Parallel Poll Configure (PPC)	AC	No

UC: Universal command; AC: Address command

- Device Clear (DCL). Will clear (initialize) all devices on the bus that have a device clear function, whether or not the controller has addressed them.
- Local Lockout (LLO). Disables the return to local function.
- Serial Poll Disable (SPD). Changes all devices on the bus from the serial poll state to the normal operating state.
- Serial Poll Enable (SPE). Puts all bus devices that have a service request function into the serial poll enabled state. In this state, each device sends the controller its status byte, instead of its normal output, after the device receives its talk address on the data lines. This function may be used to determine which device sent a service request.
- Go To Local (GTL). Causes the listen-addressed device to switch from remote to local (front-panel) control.
- Select Device Clear (SDC). Clears or initializes all listen-addressed devices.
- Group Execute Trigger (GET). Triggers all applicable devices and causes them to initiate their programmed actions.
- Take Control (TCT). Allows the controller in charge to pass control of the bus to another controller on the bus.
- Parallel Poll Configure (PPC). Causes the listen-addressed device to respond to the secondary commands Parallel Poll Enable (PPE) and Parallel Poll Disable (PPD), which are placed on the bus following the PPC command. PPE enables a device with parallel poll capability to respond on a particular data line. PPD disables the device from responding to the parallel poll.

Appendix C: Factory Initialization Settings

The factory initialization settings provide you a known state for the analyzer. The *RST command returns the instrument settings to the factory defaults for the measurement mode specified with :INSTRument[:SElect]. Factory initialization sets values as shown in Table C-1 through C-12.

Table C- 1: IEEE common commands

Header	Default value
*ESE	255
*OPC	1
*SRE	0

Table C- 2: :CALibration commands

Header	Default value
:CALibration:AUTO	ON
:CALibration:IQ:VFRame:BNUMBER	0
:CALibration:IQ:VFRame[:TYPE]	ALL

Table C- 3: :DISPlay commands

Header	Default value
:DISPlay:CCDF subgroup	
:DISPlay:CCDF:LINE:GAUSSian[:STATE]	ON
:DISPlay:CCDF:LINE:REFerence[:STATE]	OFF
:DISPlay:CCDF:X[:SCALE]:AUTO	ON
:DISPlay:OVlew subgroup	
:DISPlay:OVlew:FORMat	WAVEform
:DISPlay:OVlew:OTINdicator	OFF
:DISPlay:PULSe subgroup	
:DISPlay:PULSe:MVlew:RESult:CHPower	OFF
:DISPlay:PULSe:MVlew:RESult:DCYCLE	OFF
:DISPlay:PULSe:MVlew:RESult:EBWidth	OFF

Table C-3: :DISPlay commands (Cont.)

Header	Default value
:DISPlay:PULSe:MVleW:RESult:FREQuency	OFF
:DISPlay:PULSe:MVleW:RESult:OBWidth	OFF
:DISPlay:PULSe:MVleW:RESult:OORatio	OFF
:DISPlay:PULSe:MVleW:RESult:PERiod	OFF
:DISPlay:PULSe:MVleW:RESult:PHASe	OFF
:DISPlay:PULSe:MVleW:RESult:PPOWer	OFF
:DISPlay:PULSe:MVleW:RESult:RIPPlE	OFF
:DISPlay:PULSe:MVleW:RESult:WIDTh	ON
:DISPlay:PULSe:SVleW:GUIDelines	ON
:DISPlay:PULSe:SVleW:RANGe	ADAPtive
:DISPlay:PULSe:SVleW:RESult	SINGle
:DISPlay:PULSe:SVleW:SElect	0
:DISPlay:SPECTrum subgroup	
:DISPlay:SPECTrum:BMARker:STATe	ON
:DISPlay:SPECTrum:GRATicule:GRID	FIX
:DISPlay:SPECTrum:MLINe:AMPLitude:INTerval	0 dB
:DISPlay:SPECTrum:MLINe:AMPLitude:OFFSet	0 dBm
:DISPlay:SPECTrum:MLINe:AMPLitude[:STATe]	OFF
:DISPlay:SPECTrum:MLINe:ANNotation[:STATe]	ON
:DISPlay:SPECTrum:MLINe:FREQuency:INTerval	0 Hz
:DISPlay:SPECTrum:MLINe:FREQuency:OFFSet	Center frequency
:DISPlay:SPECTrum:MLINe:FREQuency[:STATe]	OFF
:DISPlay:TFRequency subgroup	
:DISPlay:TFRequency:SGRam:MLINe:ANNotation[:STATe]	ON
:DISPlay:TFRequency:SGRam:MLINe:FREQuency:INTerval	0 Hz
:DISPlay:TFRequency:SGRam:MLINe:FREQuency:OFFSet	Center frequency
:DISPlay:TFRequency:SGRam:MLINe:FREQuency[:STATe]	OFF
:DISPlay:TFRequency:SGRam:MLINe:TIME:INTerval	0 s
:DISPlay:TFRequency:SGRam:MLINe:TIME:OFFSet	0 s
:DISPlay:TFRequency:SGRam:MLINe:TIME[:STATe]	OFF

Table C- 3: :DISPlay commands (Cont.)

Header	Default value
:DISPlay[:VIEW] subgroup	
:DISPlay[:VIEW]:BRIGhtness	1.0 (100%)
:DISPlay[:VIEW]:FORMat	V1S (SANORMAL) MULTitude (Other than above)

Table C- 4: :DISPlay commands (Option)

Header	Default value
Option 21 General purpose modulation analysis related	
:DISPlay:DDEMod subgroup	
:DISPlay:DDEMod:CCDF:LINE:GAUSSian[:STATe]	ON
:DISPlay:DDEMod:MView[:SVIew:DStArt]	AUTO
:DISPlay:DDEMod:MView:FORMat	OFF
:DISPlay:DDEMod:MView[:SVIew:HSSHift]	NONE
:DISPlay:DDEMod:MView[:SVIew:RADIx]	BINary
:DISPlay:DDEMod:NLINearity:LINE:BFIT[:STATe]	ON
:DISPlay:DDEMod:NLINearity:LINE:REFerence[:STATe]	ON
:DISPlay:DDEMod:NLINearity:MASK[:STATe]	ON
:DISPlay:DDEMod:SVIew:FORMat	SPECtrum
:DISPlay:RFID:DDEMod subgroup	
:DISPlay:RFID:DDEMod:MView[:SVIew:AREA[:PERCent]	100
:DISPlay:RFID:DDEMod:MView[:SVIew:BURSt[:NUMBer]	0
:DISPlay:RFID:DDEMod:MView[:SVIew:EDGE[:NUMBer]	0
:DISPlay:RFID:DDEMod:MView[:SVIew:ENVELOpe[:NUMBer]	0
:DISPlay:RFID:DDEMod:MView[:SVIew:GUIDeline[:STATe]	ON
:DISPlay:RFID:DDEMod:SVIew:FORMat	SPECtrum

Table C-4: :DISPlay commands (Option) (Cont.)

Header	Default value
Option 23 W-CDMA uplink related	
:DISPlay:UL3Gpp subgroup	
:DISPlay:UL3Gpp:AVIew:SHORtcode	0
:DISPlay:UL3Gpp:AVIew:SRATe	R960S
:DISPlay:UL3Gpp:AVIew:TSLot	0
:DISPlay:UL3Gpp:MVIew:FORMat	OFF
:DISPlay:UL3Gpp:MVIew :SVIew:RADIx	BINary
:DISPlay:UL3Gpp:MVIew :SVIew:Y[:SCALe]:PUNit	RELative
:DISPlay:UL3Gpp:SVIew:FORMat	SPECtrum
Option 24 GSM/EDGE related	
:DISPlay:GSMedge:DDEMod subgroup	
:DISPlay:GSMedge:DDEMod:MVIew :SVIew:FILTer:EI NVerse	ON
:DISPlay:GSMedge:DDEMod:MVIew:FORMat	EVM
:DISPlay:GSMedge:DDEMod:MVIew :SVIew:STIME	SYMBOL
:DISPlay:GSMedge:DDEMod:SVIew:FORMat	CONSte
:DISPlay:GSMedge:SPECtrum subgroup	
:DISPlay:GSMedge:SPECtrum:BMARker:STATe	ON
:DISPlay:GSMedge:WAVEform subgroup	
:DISPlay:GSMedge:WAVEform:BURSt	FULL
Option 25 cdma2000 analysis related (:Standard = :FLCDMA2K :RLCDMA2K)	
:DISPlay:Standard:CCDF subgroup	
:DISPlay:Standard:CCDF:LINE:GAUSSian[:STATe]	ON
:DISPlay:Standard:CCDF:LINE:REFerence[:STATe]	OFF
:DISPlay:Standard:CCDF:X[:SCALe]:AUTO	ON
:DISPlay:Standard:DDEMod subgroup	
:DISPLay:Standard:DDEMod:SVIew:FORMat	SPECtrum
Option 26 1xEV-DO analysis related (:Standard = :FL1XEVD0 :RL1XEVD0)	
:DISPlay:Standard:CCDF subgroup	
:DISPlay:Standard:CCDF:LINE:GAUSSian[:STATe]	ON
:DISPlay:Standard:CCDF:LINE:REFerence[:STATe]	OFF
:DISPlay:Standard:CCDF:X[:SCALe]:AUTO	ON

Table C- 4: :DISPlay commands (Option) (Cont.)

Header	Default value
:DISPlay:Standard:DDEMod subgroup	
:DISPlay:Standard:DDEMod:SVIew:FORMat	SPECtrum
Option 27 3GPP-R5 analysis related	
:DISPlay:DLR5_3GPP subgroup	
:DISPlay:DLR5_3GPP:AVIew:MSLot[:STATe]	OFF
:DISPlay:DLR5_3GPP:AVIew:SHORtcode	0
:DISPlay:DLR5_3GPP:AVIew:SRATe	COMPOSITE
:DISPlay:DLR5_3GPP:AVIew:SSCHpart	OFF
:DISPlay:DLR5_3GPP:AVIew:TSLot	0
:DISPlay:DLR5_3GPP:MVIew:FORMat	OFF
:DISPlay:DLR5_3GPP:MVIew[:SVIew:RADIx	BINary
:DISPlay:DLR5_3GPP:MVIew[:SVIew:Y[:SCALE]:PUNit	RELative
:DISPlay:DLR5_3GPP:SVIew:FORMat	SPECtrum
:DISPlay:ULR5_3GPP subgroup	
:DISPlay:ULR5_3GPP:AVIew:SRATe	R960S
:DISPlay:ULR5_3GPP:AVIew:TSLot	0
:DISPlay:ULR5_3GPP:MVIew:FORMat	OFF
:DISPlay:ULR5_3GPP:MVIew[:SVIew:RADIx	BINary
:DISPlay:ULR5_3GPP:MVIew[:SVIew:Y[:SCALE]:PUNit	RELative
:DISPlay:ULR5_3GPP:SVIew:FORMat	SPECtrum
Option 28 TD-SCDMA analysis related	
:DISPlay:TD_SCDMA:DDEMod subgroup	
:DISPlay:TD_SCDMA:DDEMod:MVIew:FORMat	WAVEform
:DISPlay:TD_SCDMA:DDEMod:MVIew[:SVIew:Y[:SCALE]:PUNit	RELative
Option 29 analysis related	
:DISPlay:M2WLAN:DDEMod subgroup	
:DISPlay:M2WLAN:DDEMod:MVIew[:SVIew:MCONtent	EVM
:DISPlay:M2WLAN:DDEMod:MVIew[:SVIew:RADIx	BINary
:DISPlay:M2WLAN:DDEMod:MVIew[:SVIew:RXAntenna[:SElect]	ONE
:DISPlay:M2WLAN:DDEMod:MVIew:TYPE	GRAPh
:DISPlay:M2WLAN:DDEMod:SVIew:FORMat	SPECtrum
:DISPlay:M2WLAN:DDEMod:MVIew[:SVIew:Y[:SCALE]:PWUNit	DBM
:DISPlay:M2WLAN:DDEMod:MVIew[:SVIew:Y[:SCALE]:UNIT	HZ

Table C-4: :DISPlay commands (Option) (Cont.)

Header	Default value
:DISPlay:SWLAN:DDEMod subgroup	
:DISPlay:SWLAN:DDEMod:MVlew:FORMat	OLINearity
:DISPlay:SWLAN:DDEMod:MVlew :SVlew:MCONtent	EVM
:DISPlay:SWLAN:DDEMod:MVlew :SVlew:RADix	BINary
:DISPlay:SWLAN:DDEMod:MVlew:TYPE	GRAPh
:DISPlay:SWLAN:DDEMod:SVlew:FORMat	SPECtrum
:DISPlay:SWLAN:DDEMod:MVlew :SVlew:X[:SCALe]:CPOSition	CENter
:DISPlay:SWLAN:DDEMod:MVlew :SVlew:Y[:SCALe]:PWUNit	DBM
:DISPlay:SWLAN:DDEMod:MVlew :SVlew:Y[:SCALe]:UNIT	HZ
:DISPlay:WLAN:DDEMod subgroup	
:DISPlay:WLAN:DDEMod:MVlew:FORMat	OLINearity
:DISPlay:WLAN:DDEMod:MVlew :SVlew:MCONtent	EVM
:DISPlay:WLAN:DDEMod:MVlew :SVlew:RADix	BINary
:DISPlay:WLAN:DDEMod:SVlew:FORMat	SPECtrum
Option 40 3GPP-R6 analysis related	
:DISPlay:DLR6_3GPP subgroup	
:DISPlay:DLR6_3GPP:AVlew:CCODE	0
:DISPlay:DLR6_3GPP:AVlew:MSLot[:STATe]	OFF
:DISPlay:DLR6_3GPP:AVlew:RESult:AGSCOpe	OFF
:DISPlay:DLR6_3GPP:AVlew:RESult:AGValue	OFF
:DISPlay:DLR6_3GPP:AVlew:RESult:ANACK	OFF
:DISPlay:DLR6_3GPP:AVlew:RESult:RGRant	OFF
:DISPlay:DLR6_3GPP:AVlew:RESult:SCGRoup	ON
:DISPlay:DLR6_3GPP:AVlew:RESult:SCNumber	ON
:DISPlay:DLR6_3GPP:AVlew:RESult:SSCH	ON
:DISPlay:DLR6_3GPP:AVlew:SRATe	COMPosite
:DISPlay:DLR6_3GPP:AVlew:SSCHpart	OFF
:DISPlay:DLR6_3GPP:AVlew:TSLot	0
:DISPlay:DLR6_3GPP:MVlew:FORMat	OFF
:DISPlay:DLR6_3GPP:MVlew :SVlew:RADix	BINary
:DISPlay:DLR6_3GPP:MVlew :SVlew:Y[:SCALe]:PUNit	RELative
:DISPlay:DLR6_3GPP:SVlew:FORMat	SPECtrum

Table C- 4: :DISPlay commands (Option) (Cont.)

Header	Default value
:DISPlay:ULR6_3GPP subgroup	
:DISPlay:ULR6_3GPP:AVIew:CCODE	0
:DISPlay:ULR6_3GPP:AVIew:CNUMber	0
:DISPlay:ULR6_3GPP:AVIew:FORMat	CHANnel
:DISPlay:ULR6_3GPP:AVIew:IQBRanch	BOTH
:DISPlay:ULR6_3GPP:AVIew:RESult:ANACK	OFF
:DISPlay:ULR6_3GPP:AVIew:RESult:CQI	OFF
:DISPlay:ULR6_3GPP:AVIew:RESult:ETFCi	OFF
:DISPlay:ULR6_3GPP:AVIew:RESult:HAPPy	OFF
:DISPlay:ULR6_3GPP:AVIew:RESult:OFFSet	OFF
:DISPlay:ULR6_3GPP:AVIew:RESult:PREamble	ON
:DISPlay:ULR6_3GPP:AVIew:RESult:RSN	OFF
:DISPlay:ULR6_3GPP:AVIew:RESult:SIGNature	ON
:DISPlay:ULR6_3GPP:AVIew:RESult:TFCI	OFF
:DISPlay:ULR6_3GPP:AVIew:RESult:TPC	OFF
:DISPlay:ULR6_3GPP:AVIew:SRATe	COMPOSITE
:DISPlay:ULR6_3GPP:AVIew:TSLot	0
:DISPlay:ULR6_3GPP:MVIew:FORMat	OFF
:DISPlay:ULR6_3GPP:MVIew :SVIew:RADIx	BINary
:DISPlay:ULR6_3GPP:MVIew :SVIew:X[:SCALE]:LINE	-27 dBm
:DISPlay:ULR6_3GPP:MVIew :SVIew:Y[:SCALE]:PUNit	RELative
:DISPlay:ULR6_3GPP:SVIew:FORMat	SPECTrum

Table C- 5: :FORMat commands

Header	Default value
:FORMat:BORDER	NORMal
:FORMat[:DATA]	REAL,32

Table C-6: :INITiate commands

Header	Default value
:INITiate:CONTinuous	OFF

Table C-7: :INPut commands

Header	Default value
:INPut:ATTenuation	15 dB
:INPut:ATTenuation:AUTO	ON
:INPut:MLEVel	0 dB
:INPut:MIXer	-15 dBm

Table C-8: :SENSe commands

Header	Default value
[[:SENSe]:ACPower subgroup	
[[:SENSe]:ACPower:BANDwidth]:BWIDth:ACHannel	3.6 MHz
[[:SENSe]:ACPower:BANDwidth]:BWIDth:INTegration	3.6 MHz
[[:SENSe]:ACPower:CSPacing	5.04 MHz
[[:SENSe]:ACPower:FILTer:TYPE	NYQuist
[[:SENSe]:ACPower:FILTer:COEFFicient	0.5
[[:SENSe]:ADEMod subgroup	
[[:SENSe]:ADEMod:AM:CADetection	AVERage
[[:SENSe]:ADEMod:BLOCK	0
[[:SENSe]:ADEMod:CARRier:OFFSet	0
[[:SENSe]:ADEMod:CARRier:SEARCh	ON
[[:SENSe]:ADEMod:FM:THReshold	-35 dB
[[:SENSe]:ADEMod:LENGth	2048
[[:SENSe]:ADEMod:MODulation	OFF
[[:SENSe]:ADEMod:OFFSet	0
[[:SENSe]:ADEMod:PM:THReshold	-35 dB

Table C- 8: :SENSe commands (Cont.)

Header	Default value
[:SENSe]:AVERage subgroup	
[:SENSe]:AVERage:COUNT	20
[:SENSe]:AVERage[:STATe]	OFF
[:SENSe]:AVERage:TCONtrol	EXPonential
[:SENSe]:BSIZe subgroup	
[:SENSe]:BSIZe	8
[:SENSe]:CCDF subgroup	
[:SENSe]:CCDF:BLOCK	0
[:SENSe]:CCDF:THReshold	-150 dBm
[:SENSe]:CFRequency subgroup	
[:SENSe]:CFRequency:CRESolution	1 Hz
[:SENSe]:CHPower subgroup	
[:SENSe]:CHPower:BANDwidth[:BWIDth:INTEgration]	7.2 MHz
[:SENSe]:CHPower:FILTer:COEFFicient	0.5
[:SENSe]:CHPower:FILTer:TYPE	NYQuist
[:SENSe]:CNRatio subgroup	
[:SENSe]:CNRatio:BANDwidth[:BWIDth:INTEgration]	3.6 MHz
[:SENSe]:CNRatio:BANDwidth[:BWIDth:NOISe]	3.6 MHz
[:SENSe]:CNRatio:FILTer:COEFFicient	0.5
[:SENSe]:CNRatio:FILTer:TYPE	NYQuist
[:SENSe]:CNRatio:OFFSet	10.8 MHz
[:SENSe]:CORRection subgroup	
[:SENSe]:CORRection:OFFSet[:MAGNitude]	0
[:SENSe]:CORRection:OFFSet:FREQuency	0
[:SENSe]:CORRection[:STATe]	OFF
[:SENSe]:CORRection:X:SPACing	LINear
[:SENSe]:CORRection:Y:SPACing	LOGarithmic
[:SENSe]:EBWidth subgroup	
[:SENSe]:EBWidth:XDB	-30 dB
[:SENSe]:FEED subgroup	
[:SENSe]:FEED	RF

Table C-8: :SENSe commands (Cont.)

Header	Default value
[:SENSe]:FREQuency subgroup	
[:SENSe]:FREQuency:CENTer	1.5 GHz
[:SENSe]:FREQuency:CENTer:STEP:AUTO	ON
[:SENSe]:FREQuency:CENTer:STEP[:INCRement]	3.6 MHz
[:SENSe]:FREQuency:CTABLE[:SELect]	"None"
[:SENSe]:FREQuency:SPAN	36 MHz
[:SENSe]:FREQuency:STARt	1.482 GHz
[:SENSe]:FREQuency:STOP	1.518 GHz
[:SENSe]:OBWidth subgroup	
[:SENSe]:OBWidth:PERCent	99%
[:SENSe]:PULSe subgroup	
[:SENSe]:PULSe:BLock	0
[:SENSe]:PULSe:CHPower:BANDwidth[:BWIDTH:INTegration]	1 MHz
[:SENSe]:PULSe:CRESolution	1 Hz
[:SENSe]:PULSe:EBWidth:XDB	-30 dB
[:SENSe]:PULSe:FILTer:COEFFicient	0.35
[:SENSe]:PULSe:FILTer:BANDwidth[:BWIDTH]	3.6 MHz
[:SENSe]:PULSe:FILTer:MEASurement	OFF
[:SENSe]:PULSe:OBWidth:PERCent	99%
[:SENSe]:PULSe:PTOffset	0
[:SENSe]:PULSe:THReshold	-3 dBc
[:SENSe]:ROSCillator subgroup	
[:SENSe]:ROSCillator:SOURce	INTernal
[:SENSe]:SPECtrum subgroup	
[:SENSe]:SPECtrum:AVERAge:COUNT	20
[:SENSe]:SPECtrum:AVERAge[:STATe]	OFF
[:SENSe]:SPECtrum:AVERAge:TYPE	RMS
[:SENSe]:SPECtrum:BANDwidth[:BWIDTH[:RESolution]]	100 kHz
[:SENSe]:SPECtrum:BANDwidth[:BWIDTH[:RESolution]:AUTO]	ON
[:SENSe]:SPECtrum:BANDwidth[:BWIDTH:STATe]	ON
[:SENSe]:SPECtrum:BANDwidth[:BWIDTH:VIDeo]	0
[:SENSe]:SPECtrum:BANDwidth[:BWIDTH:VIDeo:STATe]	OFF
[:SENSe]:SPECtrum:BANDwidth[:BWIDTH:VIDeo:SWEep[:TIME]]	0

Table C- 8: :SENSe commands (Cont.)

Header	Default value
[:SENSe]:SPEctrum:DETEctor[:FUNction]	POSitive
[:SENSe]:SPEctrum:FILTer:COEFFicient	0.5
[:SENSe]:SPEctrum:FILTer:TYPE	GAUSSian
[:SENSe]:SPEctrum:FFT:ERESolution	OFF
[:SENSe]:SPEctrum:FFT:LENGth	8192
[:SENSe]:SPEctrum:FFT:STARt	1024
[:SENSe]:SPEctrum:FFT:WINDow[:TYPE]	BH4B
[:SENSe]:SPEctrum:FRAMe	0
[:SENSe]:SPEctrum:MEASurement	OFF
[:SENSe]:SPEctrum:ZOOM:BLOCK	0
[:SENSe]:SPEctrum:ZOOM:FREQuency:CENTer	Center frequency
[:SENSe]:SPEctrum:ZOOM:FREQuency:WIDTh	Span
[:SENSe]:SPEctrum:ZOOM:OFFSet	256
[:SENSe]:SPURious subgroup	
[:SENSe]:SPURious[:THReshold]:EXCURsion	3 dB
[:SENSe]:SPURious[:THReshold]:IGNore	0 Hz
[:SENSe]:SPURious[:THReshold]:SIGNal	-20 dBm
[:SENSe]:SPURious[:THReshold]:SPURious	-70 dB
[:SENSe]:TRANsient subgroup	
[:SENSe]:TRANsient:BLOCK	0
[:SENSe]:TRANsient:ITEM	OFF
[:SENSe]:TRANsient:LENGth	2048
[:SENSe]:TRANsient:OFFSet	0

Table C- 9: :SENSe commands (Option)

Header	Default value
Option 21 General purpose modulation analysis related	
[:SENSe]:DDEMod subgroup	
[:SENSe]:DDEMod:BLOCK	0
[:SENSe]:DDEMod:CARRier:OFFSet	0
[:SENSe]:DDEMod:CARRier:SEARCh	ON

Table C-9: :SENSe commands (Option) (Cont.)

Header	Default value
[:SENSe]:DDEMod:FILTer:ALPHa	0.3
[:SENSe]:DDEMod:FILTer:MEASurement	OFF
[:SENSe]:DDEMod:FILTer:REFErence	GAUSSian
[:SENSe]:DDEMod:FORMat	GMSK
[:SENSe]:DDEMod:LENGth	1536
[:SENSe]:DDEMod:NLINearity:COEFFicient	8
[:SENSe]:DDEMod:NLINearity:HDIVision	0.1
[:SENSe]:DDEMod:NLINearity:LSRegion[:SET]	-10
[:SENSe]:DDEMod:NLINearity:LSRegion:UNIT	RELative
[:SENSe]:DDEMod:OFFSet	256
[:SENSe]:DDEMod:PRESet	OFF
[:SENSe]:DDEMod:SRATE	270.833 kspS
[:SENSe]:RFID subgroup	
[:SENSe]:RFID:ACPower:Bandwidth[:BWiDth:ACHannel]	3.6 MHz
[:SENSe]:RFID:ACPower:Bandwidth[:BWiDth:INTEgration]	3.6 MHz
[:SENSe]:RFID:ACPower:CSPacing	5.04 MHz
[:SENSe]:RFID:ACPower:FILTer:COEFFicient	0.5
[:SENSe]:RFID:ACPower:FILTer:TYPE	NYQuist
[:SENSe]:RFID:BLOCK	0
[:SENSe]:RFID:CARRier:Bandwidth[:BWiDth:INTEgration]	36 MHz
[:SENSe]:RFID:CARRier:COUNter[:RESolution]	1 Hz
[:SENSe]:RFID:CARRier:OFFSet	0 dB
[:SENSe]:RFID:CARRier:PRATio[:SET]	-20 dB
[:SENSe]:RFID:CARRier:PRATio:UNIT	dB
[:SENSe]:RFID:LENGth	512
[:SENSe]:RFID:MEASurement	OFF
[:SENSe]:RFID:MODulation:ADVanced:FILTer	OFF
[:SENSe]:RFID:MODulation:ADVanced:PREamble	ON
[:SENSe]:RFID:MODulation:ADVanced:SBAND	ON
[:SENSe]:RFID:MODulation:BRATe:AUTO	UPPer
[:SENSe]:RFID:MODulation:BRATe[:SET]	40 kbps
[:SENSe]:RFID:MODulation:DECode	"NRZ"
[:SENSe]:RFID:MODulation:FORMat	"ASK"

Table C-9: :SENSe commands (Option) (Cont.)

Header	Default value
[:SENSe]:RFID:MODulation:INTerpolate	0
[:SENSe]:RFID:MODulation:LINK	INTerrogator
[:SENSe]:RFID:MODulation:SERRor[:WIDTh]	5%
[:SENSe]:RFID:MODulation:STANdard	“MANUAL”
[:SENSe]:RFID:MODulation:TARI:AUTO	OFF
[:SENSe]:RFID:MODulation[:THReshold]:HIGHer	90%
[:SENSe]:RFID:MODulation[:THReshold]:LOWer	10%
[:SENSe]:RFID:OFFSet	256
[:SENSe]:RFID:SPURious[:THReshold]:EXCursion	3 dB
[:SENSe]:RFID:SPURious[:THReshold]:IGNore	0
[:SENSe]:RFID:SPURious[:THReshold]:SIGNal	-20 dBm
[:SENSe]:RFID:SPURious[:THReshold]:SPURious	-70 dBc
[:SENSe]:SSource subgroup	
[:SENSe]:SSource:BLOCK	0
[:SENSe]:SSource:CARRier:BANDwidth[:BWIDth:INTEgration	Span/100
[:SENSe]:SSource:CARRier[:THReshold]	-20 dBm
[:SENSe]:SSource:CARRier:TRACKing[:STATe]	ON
[:SENSe]:SSource:CNRatio:FFT:LENGth	1024
[:SENSe]:SSource:CNRatio:OFFSet	10 Hz
[:SENSe]:SSource:CNRatio:SBANd	UPPer
[:SENSe]:SSource:CNRatio[:THReshold]	-30 dBc/Hz
[:SENSe]:SSource:FVTime:SMOothing	1
[:SENSe]:SSource:FVTime[:THReshold]	10 Hz
[:SENSe]:SSource:LENGth	1024
[:SENSe]:SSource:MEASurement	OFF
[:SENSe]:SSource:OFFSet	512
[:SENSe]:SSource:PNOise:MPJitter[:THReshold]	10 dB
[:SENSe]:SSource:PNOise:RJITter:OFFSet:STARt	10 Hz
[:SENSe]:SSource:PNOise:RJITter:OFFSet:STOP	100 MHz
[:SENSe]:SSource:PNOise:RJITter[:THReshold]	0
[:SENSe]:SSource:PNOise:OFFSet:MAXimum	100 MHz
[:SENSe]:SSource:PNOise:OFFSet:MINimum	10 Hz

Table C-9: :SENSE commands (Option) (Cont.)

Header	Default value
[:SENSE]:SSource:SPURious:IGNore	0
[:SENSE]:SSource:SPURious:SFILter[:STATE]	ON
[:SENSE]:SSource:SPURious[:THReshold]:EXCursion	3
[:SENSE]:SSource:SPURious[:THReshold]:SPURious	-70 dBc
Option 23 W-CDMA analysis related	
[:SENSE]:AC3Gpp subgroup	
[:SENSE]:AC3Gpp:FILTer:ALPHa	0.22
[:SENSE]:AC3Gpp:FILTer:TYPE	RNYQuist
[:SENSE]:UL3Gpp subgroup	
[:SENSE]:UL3Gpp:BLOCK	0
[:SENSE]:UL3Gpp:CARRier:OFFSet	0
[:SENSE]:UL3Gpp:CARRier:SEARch	ON
[:SENSE]:UL3Gpp:FILTer:ALPHa	0.22
[:SENSE]:UL3Gpp:FILTer:MEASurement	RRCosine
[:SENSE]:UL3Gpp:FILTer:REFerence	RCOSine
[:SENSE]:UL3Gpp:LENGth	512000
[:SENSE]:UL3Gpp:MMODE	DPCH
[:SENSE]:UL3Gpp:OFFSet	0
[:SENSE]:UL3Gpp:SCODE:NUMBer	0
[:SENSE]:UL3Gpp:SCODE:TYPE	LONG
[:SENSE]:UL3Gpp:THReshold	-30 dB
Option 24 GSM/EDGE analysis related	
[:SENSE]:GSMedge subgroup	
[:SENSE]:GSMedge:ABITs	147
[:SENSE]:GSMedge:BLOCK	0
[:SENSE]:GSMedge:BURSt:INDEX	0
[:SENSE]:GSMedge:BURSt:MPOint	HWAY
[:SENSE]:GSMedge:CARRier:OFFSet	0
[:SENSE]:GSMedge:CARRier:SEARch	ON
[:SENSE]:GSMedge:FILTer:RCWRcosine	ON
[:SENSE]:GSMedge:LIMit:SIGNal	-20
[:SENSE]:GSMedge:LIMit:SPURious	-36
[:SENSE]:GSMedge:MEASurement	MACCuracy

Table C- 9: :SENSe commands (Option) (Cont.)

Header	Default value
[:SENSe]:GSMedge:MODulation	GMSK
[:SENSe]:GSMedge:SLOT	18
[:SENSe]:GSMedge:STANdard:BAND	GSM900
[:SENSe]:GSMedge:STANdard:DIRection	UPLink
[:SENSe]:GSMedge:STINdex	1
[:SENSe]:GSMedge:TSCode:AUTO	OFF
[:SENSe]:GSMedge:TSCode[:NUMBer]	0
Option 25 cdma2000 analysis related (:Standard = :FLCDMA2K :RLCDMA2K)	
[:SENSe]:Standard subgroup	
[:SENSe]:Standard:ACQuisition:CHIPs	4608
[:SENSe]:Standard:ACQuisition:HISTory	0
[:SENSe]:Standard:ACQuisition:SEConds	3.75 ms
[:SENSe]:Standard:ANALysis:INTerval	3072
[:SENSe]:Standard:ANALysis:OFFSet	0
[:SENSe]:Standard:BLOCK	0
[:SENSe]:Standard:MEASurement	OFF
[:SENSe]:Standard:SPECTrum:OFFSet	0
[:SENSe]:Standard:SPECTrum:TINTerval	160 μ s
[:SENSe]:Standard:ACPower subgroup	
[:SENSe]:Standard:ACPower:BANDwidth[:BWIDth:INTegration]	1.23 MHz
[:SENSe]:Standard:ACPower:FILTer:TYPE	RECTangle
[:SENSe]:Standard:ACPower:LIMit:ADJacent<x>[:STATE]	x=1 to 6: ON x=7 to 12: OFF
[:SENSe]:Standard:CCDF subgroup	
[:SENSe]:Standard:CCDF:THReshold	-150 dBm
[:SENSe]:Standard:CDPower subgroup	
[:SENSe]:Standard:CDPower:ACCThreshold	-27 dB
[:SENSe]:Standard:CDPower:FILTer:MEASurement	FLCDMA2K: EQComp RLCDMA2K: COMP
[:SENSe]:Standard:CDPower:IQSWap	OFF
[:SENSe]:Standard:CDPower:MLEVel	SYMBOL0

Table C-9: :SENSE commands (Option) (Cont.)

Header	Default value
[:SENSE]:FLCDMA2K:CDPower:PNOFset	0
[:SENSE]:FLCDMA2K:CDPower:QOF	0
[:SENSE]:Standard:CDPower:SElect:CODE	0
[:SENSE]:Standard:CDPower:SElect:PCG	0
[:SENSE]:Standard:CDPower:WCOde	COMPosite
[:SENSE]:Standard:CHPower subgroup	
[:SENSE]:Standard:CHPower:BANDwidth :BWIDth:INTegration	1.23 MHz
[:SENSE]:Standard:CHPower:FiLTer:TYPE	RECTangle
[:SENSE]:Standard:CHPower:LiMiT[::STATe]	OFF
[:SENSE]:Standard:IM subgroup	
[:SENSE]:Standard:IM:BANDwidth :BWIDth:INTegration	1.23 MHz
[:SENSE]:Standard:IM:FiLTer:TYPE	RECTangle
[:SENSE]:Standard:IM:LiMiT:FORDer[::STATe]	OFF
[:SENSE]:Standard:IM:LiMiT:TORDer[::STATe]	OFF
[:SENSE]:Standard:IM:SCOFFset	1.25 MHz
[:SENSE]:Standard:MACCuracy subgroup	
[:SENSE]:Standard:MACCuracy:ACCThreshold	-27 dB
[:SENSE]:Standard:MACCuracy:FiLTer:MEASurement	FLCDMA2K: EQComp RLCDMA2K: COMP
[:SENSE]:Standard:MACCuracy:IQSWap	OFF
[:SENSE]:Standard:MACCuracy:LiMiT:EVM:PEAK[::STATe]	OFF
[:SENSE]:Standard:MACCuracy:LiMiT:EVM:RMS[::STATe]	OFF
[:SENSE]:Standard:MACCuracy:LiMiT:PCDerror[::STATe]	OFF
[:SENSE]:Standard:MACCuracy:LiMiT:RHO[::STATe]	ON
[:SENSE]:FLCDMA2K:MACCuracy:LiMiT:TAU[::STATe]	ON
[:SENSE]:Standard:MACCuracy:MLEVel	SYMBOL
[:SENSE]:FLCDMA2K:MACCuracy:PNOFset	0
[:SENSE]:FLCDMA2K:MACCuracy:QOF	0
[:SENSE]:Standard:MACCuracy:SElect:CODE	0
[:SENSE]:Standard:MACCuracy:SElect:PCG	0
[:SENSE]:Standard:MACCuracy:WCOde	COMPosite

Table C-9: :SENSe commands (Option) (Cont.)

Header	Default value
[:SENSe]:Standard:OBWidth subgroup	
[:SENSe]:Standard:OBWidth:LIMit[:STATe]	ON
[:SENSe]:Standard:OBWidth:PERCent	99%
[:SENSe]:Standard:PCCHannel subgroup	
[:SENSe]:Standard:PCCHannel:ACCThreshold	-27 dB
[:SENSe]:Standard:PCCHannel:FILTer:MEASurement	FLCDMA2K: EQComp RLCDMA2K: COMP
[:SENSe]:Standard:PCCHannel:IQSWap	OFF
[:SENSe]:Standard:PCCHannel:LIMit:PHASe[:STATe]	ON
[:SENSe]:Standard:PCCHannel:LIMit:TIME[:STATe]	ON
[:SENSe]:FLCDMA2K:PCCHannel:PNOFfset	0
[:SENSe]:Standard:PCCHannel:SElect:CODE	0
[:SENSe]:Standard:PCCHannel:SElect:PCG	0
[:SENSe]:Standard:PCCHannel:WCODe	COMPOSITE
[:SENSe]:RLCDMA2K:PVTime subgroup	
[:SENSe]:RLCDMA2K:PVTime:BURSt:SYNC	MPOINT
[:SENSe]:RLCDMA2K:PVTime:LIMit:ZONE<x>[:STATe]	x=1 and 2: ON x=3 to 5: OFF
[:SENSe]:RLCDMA2K:PVTime:RCHannel:LEVel	0 dBm
[:SENSe]:RLCDMA2K:PVTime:RCHannel:MODE	AUTO
[:SENSe]:Standard:SEMAsk subgroup	
[:SENSe]:Standard:SEMAsk:BANDwidth[:BWIDTH:INTegration]	1.2288 MHz
[:SENSe]:Standard:SEMAsk:FILTer:TYPE	RECTangle
[:SENSe]:Standard:SEMAsk:LIMit:ISPurious:ZONE<x>[:STATe]	x=1: ON x=2 to 5: OFF
[:SENSe]:Standard:SEMAsk:LIMit:OFCHannel:ZONE<x>[:STATe]	x=1 to 3: ON x= 4 and 5: OFF
[:SENSe]:Standard:SEMAsk:MEASurement	OFCHannel
[:SENSe]:Standard:SEMAsk:RCHannel:MODE	AUTO

Table C-9: :SENSE commands (Option) (Cont.)

Header	Default value
Option 26 1xEV-DO analysis related (:Standard = :FL1XEVD0 :RL1XEVD0)	
[:SENSE]:Standard subgroup	
[:SENSE]:Standard:ACQuisition:CHIPs	6144
[:SENSE]:Standard:ACQuisition:HISTory	0
[:SENSE]:Standard:ACQuisition:SEConds	5 ms
[:SENSE]:Standard:ANALysis:INTerval	6
[:SENSE]:Standard:ANALysis:OFFSet	0
[:SENSE]:Standard:BLOCK	0
[:SENSE]:Standard:MEASurement	OFF
[:SENSE]:Standard:SPECTrum:OFFSet	0
[:SENSE]:Standard:ACPower subgroup	
[:SENSE]:Standard:ACPower:BANDwidth :BWIDTH:INTegration	1.23 MHz
[:SENSE]:Standard:ACPower:FILTer:TYPE	RECTangle
[:SENSE]:Standard:ACPower:LIMit:ADJacent<x>[:STATe]	x=1 to 6: ON x=7 to 12: OFF
[:SENSE]:Standard:CCDF subgroup	
[:SENSE]:Standard:CCDF:THReshold	-150 dBm
[:SENSE]:Standard:CDPower subgroup	
[:SENSE]:Standard:CDPower:ACCThreshold	FL1XEVD0: -27 dB RL1XEVD0: -21 dB
[:SENSE]:FL1XEVD0:CDPower:CHANnel[:TYPE]	PILot
[:SENSE]:Standard:CDPower:FILTer:MEASurement	FL1XEVD0: EQComp RL1XEVD0: COMP
[:SENSE]:Standard:CDPower:IQSWap	OFF
[:SENSE]:RL1XEVD0:CDPower:LCMask:I	#H0,#H0,#H0
[:SENSE]:RL1XEVD0:CDPower:LCMask:Q	#H0,#H0,#H0
[:SENSE]:Standard:CDPower:MLEVel	SYMBOL
[:SENSE]:FL1XEVD0:CDPower:PNOFFset	0
[:SENSE]:Standard:CDPower:SELEct:CODE	0
[:SENSE]:Standard:CDPower:SELEct:HSLot	0

Table C-9: :SENSe commands (Option) (Cont.)

Header	Default value
[:SENSe]:Standard:CHPower subgroup	
[:SENSe]:Standard:CHPower:BANDwidth[:BWIDth:INtegration]	1.23 MHz
[:SENSe]:Standard:CHPower:FILTer:TYPE	RECTangle
[:SENSe]:Standard:CHPower:LIMit[:STATe]	OFF
[:SENSe]:Standard:IM subgroup	
[:SENSe]:Standard:IM:BANDwidth[:BWIDth:INtegration]	1.23 MHz
[:SENSe]:Standard:IM:FILTer:TYPE	RECTangle
[:SENSe]:Standard:IM:LIMit:FORDER[:STATe]	OFF
[:SENSe]:Standard:IM:LIMit:TORDER[:STATe]	OFF
[:SENSe]:Standard:IM:SCOFset	1.25 MHz
[:SENSe]:Standard:MACCuracy subgroup	
[:SENSe]:Standard:MACCuracy:ACCThreshold	FL1XEVD0: -27 dB RL1XEVD0: -21 dB
[:SENSe]:FL1XEVD0:MACCuracy:CHANnel[:TYPE]	PILot
[:SENSe]:Standard:MACCuracy:FILTer:MEASurement	FL1XEVD0: EQComp RL1XEVD0: COMP
[:SENSe]:Standard:MACCuracy:IQSWap	OFF
[:SENSe]:RL1XEVD0:MACCuracy:LCMask:I	#H0,#H0,#H0
[:SENSe]:RL1XEVD0:MACCuracy:LCMask:Q	#H0,#H0,#H0
[:SENSe]:Standard:MACCuracy:LIMit:EVM:PEAK[:STATe]	OFF
[:SENSe]:Standard:MACCuracy:LIMit:EVM:RMS[:STATe]	OFF
[:SENSe]:Standard:MACCuracy:LIMit:PCDerror[:STATe]	OFF
[:SENSe]:Standard:MACCuracy:LIMit:RHO[:STATe]	ON
[:SENSe]:FL1XEVD0:MACCuracy:LIMit:TAU[:STATe]	ON
[:SENSe]:Standard:MACCuracy:MLEVel	SYMBOL
[:SENSe]:FL1XEVD0:MACCuracy:PNOFset	0
[:SENSe]:Standard:MACCuracy:SElect:CODE	0
[:SENSe]:Standard:MACCuracy:SElect:HSLot	0
[:SENSe]:Standard:OBWidth subgroup	
[:SENSe]:Standard:OBWidth:LIMit[:STATe]	ON
[:SENSe]:Standard:OBWidth:PERCent	99%

Table C-9: :SENSE commands (Option) (Cont.)

Header	Default value
[[:SENSE]:Standard:PCCHannel subgroup	
[[:SENSE]:Standard:PCCHannel:ACCThreshold	FL1XEVD0: -27 dB RL1XEVD0: -21 dB
[[:SENSE]:FL1XEVD0:PCCHannel:CHANnel[:TYPE]	MAC
[[:SENSE]:Standard:PCCHannel:FILTer:MEASurement	FL1XEVD0: EQComp RL1XEVD0: COMP
[[:SENSE]:Standard:PCCHannel:IQSWap	OFF
[[:SENSE]:RL1XEVD0:PCCHannel:LCMask:I	#H0,#H0,#H0
[[:SENSE]:RL1XEVD0:PCCHannel:LCMask:Q	#H0,#H0,#H0
[[:SENSE]:Standard:PCCHannel:LIMit:PHASe[:STATE]	ON
[[:SENSE]:Standard:PCCHannel:LIMit:TIME[:STATE]	ON
[[:SENSE]:FL1XEVD0:PCCHannel:PNOFset	0
[[:SENSE]:Standard:PCCHannel:SElect:CODE	0
[[:SENSE]:Standard:PCCHannel:SElect:HSLot	0
[[:SENSE]:FL1XEVD0:PVTime subgroup	
[[:SENSE]:FL1XEVD0:PVTime:BURSt:OFFSet	416.67 μ s
[[:SENSE]:FL1XEVD0:PVTime:BURSt:SYNC	MPOint
[[:SENSE]:FL1XEVD0:PVTime:LIMit:ZONE<x>[:STATE]	x=1 to 3: ON x=4 and 5: OFF
[[:SENSE]:FL1XEVD0:PVTime:RCHannel:MODE	AUTO
[[:SENSE]:FL1XEVD0:PVTime:SLOT[:TYPE]	IDLE
[[:SENSE]:Standard:SEMask subgroup	
[[:SENSE]:Standard:SEMask:BANDwidth[:BWIDth:INtegration	1.2288 MHz
[[:SENSE]:FL1XEVD0:SEMask:BURSt:OFFSet	416.67 μ s
[[:SENSE]:FL1XEVD0:SEMask:BURSt:SYNC	MPOint
[[:SENSE]:Standard:SEMask:FILTer:TYPE	RECTangle
[[:SENSE]:Standard:SEMask:LIMit:ISpurious:ZONE<x>[:STATE]	x=1: ON x=2 to 5: OFF
[[:SENSE]:Standard:SEMask:LIMit:OFCHannel:ZONE<x>[:STATE]	x=1 to 3: ON x=4 and 5: OFF
[[:SENSE]:Standard:SEMask:MEASurement	OFCHannel
[[:SENSE]:Standard:SEMask:RCHannel:MODE	AUTO

Table C-9: :SENSe commands (Option) (Cont.)

Header	Default value
[:SENSe]:FL1XEVD0:SEMask:SLOT:GATE	200 μ s
[:SENSe]:FL1XEVD0:SEMask:SLOT[:TYPE]	ACTive
Option 27 3GPP-R5 analysis related (:Standard = :SADLR5_3GPP :SAULR5_3GPP)	
[:SENSe]:DLR5_3GPP subgroup	
[:SENSe]:DLR5_3GPP:BLOCK	0
[:SENSe]:DLR5_3GPP:CARRier:OFFSet	0
[:SENSe]:DLR5_3GPP:CARRier:SEARch	ON
[:SENSe]:DLR5_3GPP:COMPosite	ON
[:SENSe]:DLR5_3GPP:DTYPE:SEARch	ON
[:SENSe]:DLR5_3GPP:EVM:IQOffset	INCLude
[:SENSe]:DLR5_3GPP:FILTer:ALPHa	0.22
[:SENSe]:DLR5_3GPP:FILTer:MEASurement	RRCosine
[:SENSe]:DLR5_3GPP:FILTer:REFerence	RCOSine
[:SENSe]:DLR5_3GPP:LENGth	512000
[:SENSe]:DLR5_3GPP:OFFSet	0
[:SENSe]:DLR5_3GPP:SCHPart	OFF
[:SENSe]:DLR5_3GPP:SCODE:ALTErnative	NUSed
[:SENSe]:DLR5_3GPP:SCODE:NUMBer	0
[:SENSe]:DLR5_3GPP:SCODE:SEARch	OFF
[:SENSe]:Standard:ACLR subgroup	
[:SENSe]:Standard:ACLR:FILTer:COEFFicient	0.22
[:SENSe]:Standard:ACLR:FILTer:TYPE	RNYQuist
[:SENSe]:Standard:ACLR:LIMit:ADJacent<x>[:STATe]	ON
[:SENSe]:Standard:ACLR:NCORrection	OFF
[:SENSe]:Standard:ACLR:SWEep	ON
[:SENSe]:Standard:CFRequency subgroup	
[:SENSe]:Standard:CFRequency:CRESolution	1 Hz
[:SENSe]:Standard:CHPower subgroup	
[:SENSe]:Standard:CHPower:BANDwidth[:BWIDth:INTEgration]	3.84 MHz
[:SENSe]:Standard:CHPower:FILTer:COEFFicient	0.5
[:SENSe]:Standard:CHPower:FILTer:TYPE	RECTangle
[:SENSe]:Standard:CHPower:LIMit[:STATe]	OFF

Table C-9: :SENSE commands (Option) (Cont.)

Header	Default value
[[:SENSE]:Standard:EBWidth subgroup	
[[:SENSE]:Standard:EBWidth:XDB	-30 dB
[[:SENSE]:SADLR5_3GPP:MCAClr subgroup	
[[:SENSE]:SADLR5_3GPP:MCAClr:CARRier[:THReshold]	-10 dBc
[[:SENSE]:SADLR5_3GPP:MCAClr:FILTer:COEFficient	0.22
[[:SENSE]:SADLR5_3GPP:MCAClr:FILTer:TYPE	RNYQuist
[[:SENSE]:SADLR5_3GPP:MCAClr:LIMit:ADJacent<x>[:STATe]	ON
[[:SENSE]:SADLR5_3GPP:MCAClr:NCORrection	OFF
[[:SENSE]:Standard:OBWidth subgroup	
[[:SENSE]:Standard:OBWidth:LIMit[:STATe]	ON
[[:SENSE]:Standard:OBWidth:PERCent	99
[[:SENSE]:Standard:SEMask subgroup	
[[:SENSE]:Standard:SEMask:BANDwidth[:BWiDth:INtegration	3.84 MHz
[[:SENSE]:Standard:SEMask:FILTer:COEFficient	0.5
[[:SENSE]:Standard:SEMask:FILTer:TYPE	RECTangle
[[:SENSE]:Standard:SEMask:LIMit:ZONE<x>[:STATe]	ON
[[:SENSE]:Standard:SEMask:RCHannel:LEVel	0
[[:SENSE]:Standard:SEMask:RCHannel:MODE	AUTO
[[:SENSE]:ULR5_3GPP subgroup	
[[:SENSE]:ULR5_3GPP:BLOCK	0
[[:SENSE]:ULR5_3GPP:CARRier:OFFSet	0
[[:SENSE]:ULR5_3GPP:CARRier:SEARCh	ON
[[:SENSE]:ULR5_3GPP:EVM:IQOoffset	INCLude
[[:SENSE]:ULR5_3GPP:FILTer:ALPHa	0.22
[[:SENSE]:ULR5_3GPP:FILTer:MEASurement	RRCosine
[[:SENSE]:ULR5_3GPP:FILTer:REFerence	RCOSine
[[:SENSE]:ULR5_3GPP:LENGth	512000
[[:SENSE]:ULR5_3GPP:MMOde	DPCH
[[:SENSE]:ULR5_3GPP:OFFSet	0
[[:SENSE]:ULR5_3GPP:SCODE:NUMBer	0
[[:SENSE]:ULR5_3GPP:SCODE:TYPE	LONG

Table C-9: :SENSe commands (Option) (Cont.)

Header	Default value
[:SENSe]:ULR5_3GPP:SFRame:OFFSet:DTIME	1
[:SENSe]:ULR5_3GPP:SFRame:OFFSet[:STSLot]	0
[:SENSe]:ULR5_3GPP:SFRame:SEARCh	DTIME
[:SENSe]:ULR5_3GPPP:THReshold[:BURSt]	-30 dB
Option 28 TD-SCDMA analysis related	
[:SENSe]:TD_SCDMA subgroup	
[:SENSe]:TD_SCDMA:BLOCK	0
[:SENSe]:TD_SCDMA:MEASurement	OFF
[:SENSe]:TD_SCDMA:ACQuisition: subgroup	
[:SENSe]:TD_SCDMA:ACQuisition:SFRames	3
[:SENSe]:TD_SCDMA:ACQuisition:SEConds	15 ms
[:SENSe]:TD_SCDMA:ACQuisition:HISTory	0
[:SENSe]:TD_SCDMA:ANALysis: subgroup	
[:SENSe]:TD_SCDMA:ANALysis:INTerval	19200
[:SENSe]:TD_SCDMA:ANALysis:OFFSet[:CHIPs]	0
[:SENSe]:TD_SCDMA:ANALysis:OFFSet:DFRequency	0 Hz
[:SENSe]:TD_SCDMA:ANALysis:OFFSet:IQ	Yes
[:SENSe]:TD_SCDMA:ANALysis:CHANnel:THReshold	-27 dB
[:SENSe]:TD_SCDMA:ANALysis:TSLot	ALL
[:SENSe]:TD_SCDMA:ANALysis:TSLot:THReshold	-30 dB
[:SENSe]:TD_SCDMA:ANALysis:REFeRence:SFRame	DWPT
[:SENSe]:TD_SCDMA:ANALysis:Reference:TFPHase	MIDamble
[:SENSe]:TD_SCDMA:SPECTrum: subgroup	
[:SENSe]:TD_SCDMA:SPECTrum:OFFSet	0
[:SENSe]:TD_SCDMA:SELEct subgroup	
[:SENSe]:TD_SCDMA:SELEct:SFRame	0
[:SENSe]:TD_SCDMA:SELEct:TSLot	TSON
[:SENSe]:TD_SCDMA:SELEct:CODE	0
[:SENSe]:TD_SCDMA:MODulation subgroup	
[:SENSe]:TD_SCDMA:MODulation:CONTRol	AUTO
[:SENSe]:TD_SCDMA:MODulation:SYNC:UPLink	0
[:SENSe]:TD_SCDMA:MODulation:SYNC:DOWNlink	0
[:SENSe]:TD_SCDMA:MODulation:SCODE	0

Table C-9: :SENSe commands (Option) (Cont.)

Header	Default value
[:SENSe]:TD_SCDMA:MODulation:SPOint	3
[:SENSe]:TD_SCDMA:MODulation:K:ZERO	16
[:SENSe]:TD_SCDMA:MODulation:K:NZERo	16
[:SENSe]:TD_SCDMA:FILTer subgroup	
[:SENSe]:TD_SCDMA:FILTer:MEASurement	RRCosine
[:SENSe]:TD_SCDMA:CHPower subgroup	
[:SENSe]:TD_SCDMA:CHPower:BANDwidth :BWIDth:INTegration	1.6 MHz
[:SENSe]:TD_SCDMA:CHPower:LIMit[::STATe]	No
[:SENSe]:TD_SCDMA:ACLR subgroup	
[:SENSe]:TD_SCDMA:ACLR:LIMit:ADJacent[1] 2 3 4[::STATe]	Yes
[:SENSe]:TD_SCDMA:MACCuracy subgroup	
[:SENSe]:TD_SCDMA:MACCuracy:LIMit:EVM:RMS[::STATe]	Yes
[:SENSe]:TD_SCDMA:MACCuracy:LIMit:EVM:PEAK[::STATe]	No
[:SENSe]:TD_SCDMA:MACCuracy:LIMit:PCDerror[::STATe]	Yes
[:SENSe]:TD_SCDMA:MACCuracy:LIMit:RHO[::STATe]	No
[:SENSe]:TD_SCDMA:STABle subgroup	
[:SENSe]:TD_SCDMA:STABle:TPCSs:COUNT	ONE
[:SENSe]:TD_SCDMA:STABle:TPCSs:SElect	No
[:SENSe]:TD_SCDMA:IM subgroup	
[:SENSe]:TD_SCDMA:IM:BANDwidth :BWIDth:INTegration	1.28 MHz
[:SENSe]:TD_SCDMA:IM:SCOFset	1.6 MHz
[:SENSe]:TD_SCDMA:IM:LIMit:TORDER[::STATe]	Yes
[:SENSe]:TD_SCDMA:IM:LIMit:FORDER[::STATe]	Yes
[:SENSe]:TD_SCDMA:SEMAsk subgroup	
[:SENSe]:TD_SCDMA:SEMAsk:BANDwidth :BWIDth:INTegration	1.28 MHz
[:SENSe]:TD_SCDMA:SEMAsk:MEASurement	OffsetFrom-Channel
[:SENSe]:TD_SCDMA:SEMAsk:RCHannel:MODE	AUTO
[:SENSe]:TD_SCDMA:SEMAsk:DIRection	DOWNlink
[:SENSe]:TD_SCDMA:SEMAsk:LIMit:ISPurious:ZONE<x>[::STATe]	x=1: ON x=2 to 5: OFF
[:SENSe]:TD_SCDMA:SEMAsk:LIMit:OFCHannel:ZONE<x>[::STATe]	x=1 to 4: ON x=5: OFF

Table C-9: :SENSe commands (Option) (Cont.)

Header	Default value
[:SENSe]:TD_SCDMA:TOOMask subgroup	
[:SENSe]:TD_SCDMA:TOOMask:LIMit:LEVel:ONOFF[:STATe]	Yes
[:SENSe]:TD_SCDMA:TOOMask:LIMit:LEVel:MRAMP[:STATe]	Yes
[:SENSe]:TD_SCDMA:OBWidth Subgroup	
[:SENSe]:TD_SCDMA:OBWidth:PERCent	99%
[:SENSe]:TD_SCDMA:OBWidth:LIMit[:STATe]	Yes
Option 29 WLAN analysis related	
[:SENSe]:M2WLAN subgroup	
[:SENSe]:M2WLAN:ACQuisition:HISTory	0
[:SENSe]:M2WLAN:ACQuisition:SEConds	20 μ s
[:SENSe]:M2WLAN:ANALysis:LENGth	20 μ s
[:SENSe]:M2WLAN:ANALysis:OFFSet	0
[:SENSe]:M2WLAN:ANALysis:SYNC	LTFIELD
[:SENSe]:M2WLAN:BLOCK	0
[:SENSe]:M2WLAN:MEASurement	OFF
[:SENSe]:M2WLAN:PACKet[:NUMBer]	0
[:SENSe]:M2WLAN:SPECTrum:OFFSet	0
[:SENSe]:M2WLAN:SSEGment[:NUMBer]	0
[:SENSe]:M2WLAN:SUBCarrier[:NUMBer]	-64
[:SENSe]:M2WLAN:SUBCarrier:SElect	BOTH
[:SENSe]:M2WLAN:TXAntenna:SElect	ONE
[:SENSe]:SWLAN subgroup	
[:SENSe]:SWLAN:ACQuisition:HISTory	0
[:SENSe]:SWLAN:ACQuisition:SEConds	20 μ s
[:SENSe]:SWLAN:ANALysis:EQUalization[:STATe]	ON
[:SENSe]:SWLAN:ANALysis:LENGth	20 μ s
[:SENSe]:SWLAN:ANALysis:OFFSet	0
[:SENSe]:SWLAN:ANALysis:SFORMAT	ONE
[:SENSe]:SWLAN:ANALysis:SYNC	LTSYMBOL
[:SENSe]:SWLAN:BLOCK	0
[:SENSe]:SWLAN:MEASurement	OFF
[:SENSe]:SWLAN:PACKet[:NUMBer]	0
[:SENSe]:SWLAN:SMASK[:SElect]	EFFECTIVE

Table C-9: :SENSE commands (Option) (Cont.)

Header	Default value
[:SENSE]:SWLAN:SPECTrum:OFFSet	0
[:SENSE]:SWLAN:SSEGment[:NUMBer]	0
[:SENSE]:SWLAN:SUBCarrier[:NUMBer]	-64
[:SENSE]:SWLAN:SUBCarrier:SElect	BOTH
[:SENSE]:SWLAN:TXAntenna:SElect	ONE
[:SENSE]:WLAN subgroup	
[:SENSE]:WLAN:ACQuisition:HISTory	0
[:SENSE]:WLAN:ACQuisition:SEConds	20 μ s
[:SENSE]:WLAN:ANALysis:EQUalization[:STATe]	ON
[:SENSE]:WLAN:ANALysis:LENGth	20 μ s
[:SENSE]:WLAN:ANALysis:MODulation	AUTO
[:SENSE]:WLAN:ANALysis:OFFSet	0
[:SENSE]:WLAN:ANALysis:SYNC	LTSYmbol
[:SENSE]:WLAN:BLOCK	0
[:SENSE]:WLAN:MEASurement	OFF
[:SENSE]:WLAN:SMASK[:SElect]	DSSS
[:SENSE]:WLAN:SPECTrum:OFFSet	0
[:SENSE]:WLAN:SSEGment[:NUMBer]	0
[:SENSE]:WLAN:SUBCarrier[:NUMBer]	-32
[:SENSE]:WLAN:SUBCarrier:SElect	BOTH
[:SENSE]:WLAN:TPOWer:BURSt:INDex	0
[:SENSE]:WLAN:TPOWer:SLOPe	POSitive
Option 40 3GPP-R6 analysis related (:Standard = :SADLR6_3GPP :SAULR6_3GPP)	
[:SENSE]:DLR6_3GPP subgroup	
[:SENSE]:DLR6_3GPP:BLOCK	0
[:SENSE]:DLR6_3GPP:CARRier:OFFSet	0
[:SENSE]:DLR6_3GPP:CARRier:SEARch	ON
[:SENSE]:DLR6_3GPP:CCODE:EAGCh	0
[:SENSE]:DLR6_3GPP:CCODE:ERGCh	0
[:SENSE]:DLR6_3GPP:COMPOSITE	ON
[:SENSE]:DLR6_3GPP:DTYPe:SEARch	ON
[:SENSE]:DLR6_3GPP:EVM:IQOffset	ON

Table C-9: :SENSe commands (Option) (Cont.)

Header	Default value
[:SENSe]:DLR6_3GPP:FILTer:ALPHa	0.22
[:SENSe]:DLR6_3GPP:FILTer:MEASurement	RRCosine
[:SENSe]:DLR6_3GPP:FILTer:REFerence	RCOSine
[:SENSe]:DLR6_3GPP:LENGth	512000
[:SENSe]:DLR6_3GPP:OFFSet	0
[:SENSe]:DLR6_3GPP:SCHPart	OFF
[:SENSe]:DLR6_3GPP:SCODE:ALTerNative	NUSed
[:SENSe]:DLR6_3GPP:SCODE:NUMBer	0
[:SENSe]:DLR6_3GPP:SCODE:SEARCh	OFF
[:SENSe]:DLR6_3GPP:CCODE:EAGCh	0
[:SENSe]:DLR6_3GPP:CCODE:ERGCh	0
[:SENSe]:ULR6_3GPP subgroup	
[:SENSe]:ULR6_3GPP:BLOCK	0
[:SENSe]:ULR6_3GPP:CARRier:OFFSet	0
[:SENSe]:ULR6_3GPP:CARRier:SEARCh	ON
[:SENSe]:ULR6_3GPP:CCONfig	AUTO
[:SENSe]:ULR6_3GPP:DFORmat	AUTO
[:SENSe]:ULR6_3GPP:EVM:IQOffset	ON
[:SENSe]:ULR6_3GPP:EVM:TPERiods	EXClude
[:SENSe]:ULR6_3GPP:FILTer:ALPHa	0.22
[:SENSe]:ULR6_3GPP:FILTer:MEASurement	RRCosine
[:SENSe]:ULR6_3GPP:FILTer:REFerence	RCOSine
[:SENSe]:ULR6_3GPP:LENGth	512000
[:SENSe]:ULR6_3GPP:MMODE	DPCH
[:SENSe]:ULR6_3GPP:OFFSet	0
[:SENSe]:ULR6_3GPP:SCODE:NUMBer	0
[:SENSe]:ULR6_3GPP:SCODE:TYPE	LONG
[:SENSe]:ULR6_3GPP:SFRame:OFFSet:DTIME	1
[:SENSe]:ULR6_3GPP:SFRame:OFFSet[:STSLot]	0
[:SENSe]:ULR6_3GPP:SFRame:SEARCh	DTIME
[:SENSe]:ULR6_3GPP:SFRame:TOLerance	0

Table C-9: :SENSe commands (Option) (Cont.)

Header	Default value
[[:SENSe]:ULR6_3GPP:THReshold[:BURSt]	-30 dB
[[:SENSe]:ULR6_3GPP:THReshold:DTX	-11.8 dB

Table C-10: :STATus commands

Header	Default value
:STATus:OPERation:ENABle	32767
:STATus:QUEStionable:ENABle	32767
:STATus:QUEStionable[:EVENT]	0

Table C-11: :TRACe commands

Header	Default value
:TRACe<x>:AVERage:COUNT	20
:TRACe<x>:DDETeCtor	MAXimum
:TRACe<x>:MODE	NORMal
:TRACe2:MODE (Option 21 only)	MAXimum

Table C-12: :TRIGger commands

Header	Default value
:TRIGger[:SEQuence]:LEVel:EXTernal	1.4 V
:TRIGger[:SEQuence]:LEVel:IQFRequency	0
:TRIGger[:SEQuence]:LEVel:IQTime	-40 dBfs
:TRIGger[:SEQuence]:MODE	AUTO
:TRIGger[:SEQuence]:POSition	50%
:TRIGger[:SEQuence]:SAVE:COUNT[:STATe]	OFF
:TRIGger[:SEQuence]:SAVE:COUNT:MAXimum	100
:TRIGger[:SEQuence]:SAVE[:STATe]	OFF
:TRIGger[:SEQuence]:SLOPe	POSitive
:TRIGger[:SEQuence]:SOURce	IQTime

Table C- 13: :UNIT commands

Header	Default value
:UNIT:ANGLE	DEG

Appendix D: Setting Range

This section lists the setting range of the horizontal and vertical scale for the views, and of RBW (Resolution Bandwidth).

Scale Setting Range

Table D- 1: Display format and scale

Display format	Horizontal range	Vertical range
Spectrum	0 Hz to 8 GHz	-200 to +100 dBm
Spectrogram	0 Hz to 8 GHz	Frame -15999 to 0 Frame -63999 to 0 (Option 02)
Time domain view	- ($T_f \times N_f$) to 0 s *	-200 to +100 dBm (Amplitude) -30 to +30 V (I/Q level) -300 to +300% (AM) -38.4 to +38.4 MHz (FM/FVT) -675 to +675 degrees (PM)
CCDF	0 to 15.01 dB	10^{-9} to 100%

* T_f : Frame time; N_f : Frame number

Table D- 2: Display format and scale: Digital modulation analysis (Option 21)

Display format	Horizontal range	Vertical range
Constellation	- ($T_f \times N_f$) to 0 s *	fixed
EVM	- ($T_f \times N_f$) to 0 s *	-100 to +200% (EVM) -300 to +300% (amplitude error) -675 to +675 degrees (phase error)
Eye diagram	- ($T_f \times N_f$) to 0 s *	fixed
Symbol table	0 to ($1024 \times N_f$) symbols	NA

* T_f : Frame time; N_f : Frame number

Table D-3: Display format and scale: RFID Measurements (Option 21)

Measurement item	Display format	Horizontal range	Vertical range
Carrier	Waveform	Refer to Table D-1.	
	Spectrogram		
	Zoom	Same as Spectrogram.	
	Spectrum	$(\text{Center frequency}) \pm (\text{Zoomed span})/2$	-200 to 100 dBm
	Power vs. Time		-200 to 100 dBm
	Frequency vs. Time		$(\text{Center frequency}) \pm (\text{Zoomed span})/2$
	Zoomed spectrum	Same as Spectrum above.	
Spurious	Spurious	Same as Spectrum in Carrier.	
ACPR	ACPR	Same as Spectrum in Carrier.	
Power on/down	Waveform	Same as Carrier.	
	Spectrogram		
	Zoom		
	Spectrum		
	Power vs. Time		
	Frequency vs. Time		
	Power On/Down		-200 to 100 dBm
RF envelope Constellation Eye diagram Symbol table	Waveform	Same as Carrier.	
	Spectrogram		
	Zoom		
	Spectrum		
	Power vs. Time		
	Frequency vs. Time		
	RF Envelope		-50 to 100 mV
	Constellation	Refer to Table D-2.	
	Eye Diagram		
	Symbol Table		

Table D-4: Display format and scale: Signal source analysis (Option 21)

Measurement item	Display format	Horizontal range	Vertical range
Phase noise	Spectrum	(Center frequency) \pm (Span)/2	-200 to +100 dBm
	C/N vs. Offset frequency	10 Hz to 100 MHz	-310 to +140 dBc/Hz
Spurious	Spurious	(Center frequency) \pm (Span)/2	-200 to +100 dBm
Real-time phase noise	Spectrogram	Refer to Table D-1.	
	Power vs. Time		
	Spectrum	Same as that in Phase noise.	
	Noisogram	10 Hz to 100 MHz	Vertical: 40 to 40960 frames Color: -230 to 70 dBc/Hz
	Equiv. jitter vs. Time	-(Acquisition length) to 0 s	0 to 0.1 s
	RMS noise vs. Time	-(Acquisition length) to 0 s	0 to 359 degrees / 0 to 6.28 radians
	C/N vs. Time	0 to (Analysis length) s	-310 to +140 dBc/Hz
	C/N vs. Offset frequency	Same as that in Phase noise.	
Real-time spurious	Spectrogram	Refer to Table D-1.	
	Power vs. Time		
	Spectrum	Same as that in Phase noise.	
	Noisogram	10 Hz to 100 MHz	Vertical: 40 to 40960 frames Color: -230 to 70 dBc/Hz
	C/N vs. Offset frequency	Same as that in Phase noise.	
	Spurious	Same as that in Spurious above.	
Frequency vs. Time	Spectrogram	Refer to Table D-1.	
	Power vs. Time		
	Spectrum	Same as that in Phase noise.	
	Frequency vs. Time	Refer to Table D-1.	

Table D-5: W-CDMA (Option 23), 3GPP-R5 (Option 27), and 3GPP-R6 (Option 40) analyses

Display format	Horizontal range	Vertical range
CDP spectrogram *	0 to 511 channels	Slot -3999 to 0 Slot -15999 to 0 (Option 02)
CDP vs. Short code *	0 to 511 channels	-200 to +100 dB/dBm
CDP vs. Symbol *	0 to 639 symbols	-200 to +100 dB/dBm
CDP vs. Time slot *	-3999 to 0 slot -15999 to 0 slot (Option 02)	-200 to +100 dB/dBm
Symbol constellation	0 to 639 symbols	fixed
Symbol EVM	0 to 639 symbols	-100 to +200% (EVM) -300 to +300% (amplitude error) -675 to +675 degrees (phase error)
Symbol eye diagram	0 to 639 symbols	fixed

* CDP: Code Domain Power

Table D-6: Display format and scale, cdma2000 analysis (Option 25)

Display format	Link	Horizontal range	Vertical range
Code domain power	Forward link	RC1/RC2: 16 to 64 channels RC3/RC4/RC5: 16 to 128 channels	Relative: -200 to +100 dB Absolute: -160 to +140 dBm
	Reverse link	RC3/RC4: 16 to 64 channels	
Modulation accuracy	Both	Fixed	Fixed
EVM	Forward link	Chip: 24 to 1536 Symbol: 24 (fixed)	-100 to +200%
	Reverse link	Chip: 24 to 1536 Symbol: 24 to 48	
Amplitude (Mag) error	Both	Same as in EVM	-300 to +300%
Phase error	Both	Same as in EVM	-675 to +675 degrees
Power codogram	Both	Same as in Code domain power	Frame -6144 to 0 Frame -24579 to 0 (Option 02)
Symbol table	Both	Maximum 256	NA
IQ power graph	Both	Same as in EVM	Frame -6144 to 0 Frame -24579 to 0 (Option 02)
Constellation	Both	Fixed	Fixed

Table D-7: Display format and scale, 1xEV-DO analysis (Option 26)

Display format	Link	Horizontal range	Vertical range																		
Code domain power	Forward link	MAC: 64 codes Pilot: 32 codes Data: 16 codes Preamble: 32 codes	Relative: -200 to +100 dB Absolute: -160 to +140 dBm																		
	Reverse link	16 codes																			
Modulation accuracy	Both	Fixed	Fixed																		
EVM	Forward link	<table border="1"> <thead> <tr> <th>Channel</th> <th>Chip</th> <th>Symbol</th> </tr> </thead> <tbody> <tr> <td>Overall</td> <td>1024</td> <td>-</td> </tr> <tr> <td>MAC</td> <td>128</td> <td>2</td> </tr> <tr> <td>Pilot</td> <td>96</td> <td>3</td> </tr> <tr> <td>Data</td> <td>max 800</td> <td>max 50</td> </tr> <tr> <td>Preamble</td> <td>max 800</td> <td>max 25</td> </tr> </tbody> </table>	Channel	Chip	Symbol	Overall	1024	-	MAC	128	2	Pilot	96	3	Data	max 800	max 50	Preamble	max 800	max 25	-100 to +200%
	Channel	Chip	Symbol																		
Overall	1024	-																			
MAC	128	2																			
Pilot	96	3																			
Data	max 800	max 50																			
Preamble	max 800	max 25																			
Reverse link	Chip: 1024 Symbol: max 256																				
Amplitude (Mag) error	Both	Same as in EVM	-300 to +300%																		
Phase error	Both	Same as in EVM	-675 to +675 degrees																		
Power codogram	Both	Same as in Code domain power	Frame -6144 to 0 Frame -24579 to 0 (Option 02)																		
Symbol table	Forward link	MAC: 2 Pilot: 3 Data: max 50 Preamble: max 25	NA																		
	Reverse link	max 256																			
IQ power graph	Both	Same as in EVM	Frame -6144 to 0 Frame -24579 to 0 (Option 02)																		
Constellation	Both	Fixed	Fixed																		

Table D-8: Display format and scale, TD-SCDMA analysis (Option 28)

Display format	Horizontal range	Vertical range
Spectrum	0 Hz to 8 GHz	-200 to +100 dBm
Spectrogram	0 Hz to 8 GHz	Frame -15999 to 0 Frame -63999 to 0 (Option 02)
Code domain power	16 codes	Relative: -200 to +100 dB Absolute: -160 to 140 dBm
CDP versus subframe	Variable Maximum: 4000 subframes (Standard), 1000 subframes (Opt 02)	Relative: -200 to +100 dB Absolute: -160 to 140 dBm
CDP versus symbol	Data: Variable, based on spreading factor. Maximum: 704	Relative: -200 to +100 dB Absolute: -160 to 140 dBm
CDP codogram	16 codes	-1000 to 0 subframes (Standard) -2047 to 0 subframes (Option 02)
Composite constellation	Fixed	Fixed
Symbol constellation	Fixed	Fixed
EVM	704 symbols maximum	-100 to +200%
Magnitude error	704 symbols maximum	-300 to +300%
Phase error	704 symbols maximum	-675 to +675 degrees
Symbol table	Data: 704 maximum	NA
Power versus time	Timeslot Summary (full burst): 0 to +675 μ sec and 6.25 μ sec additional pre/post timeslot data (and chip position within subframe) Subframe Summary: -5.0 msec to 0 msec (6400 chip) Transmit On/Off Mask: Same as subframe summary	-200 to +100 dBm

Table D-9: Display format and scale, WLAN analysis (Option 29)

Display format	Signal type	Horizontal range	Vertical range	Color range
Transfer Function (Amplitude)	All (11n only)	Subcarrier # - 64 to 63	200 to 100 dBm	-
Transfer Function (Phase)	All (11n only)	Subcarrier # - 64 to 63	-1200 to 1200 °	-
Delay Profile	All (11n only)	-100 to 0 ms	-200 to 100 dBm	-
Transfogram (Amplitude)	All (11n only)	Subcarrier # - 64 to 63	58 to 59392 packets	-200 to 100 dBm
Transfogram (Phase)	All (11n only)	Subcarrier # - 64 to 63	58 to 59392 packets	-1200 to 1200 °
Delayogram	All (11n only)	-100 to 0 ms	58 to 59392 packets	-200 to 100 dBm
EVM versus Time	All	-100 to 0 ms	-100 to +200%	-
Magnitude error versus Time	All	-100 to 0 ms	-300 to +300 %	-
Phase error versus Time	All	-100 to 0 ms	-675 to +675 °	-
Power versus Time	All	-100 to 0 ms	-100 to +50 dBm	-
Constellation	All	Fixed	Fixed	-
	Non-OFDM	-100 to 0 ms		-
EVM versus SC	OFDM	Subcarrier # -32 to 31 (11a/b/g) -64 to 63 (11n)	-100 to +200%	-
	Non-OFDM	-100 to 0 ms		-
Magnitude error versus SC	OFDM	Subcarrier # -32 to 31 (11a/b/g) -64 to 63 (11n)	-300 to +300%	-
	Non-OFDM	-100 to 0 ms		-
Phase error versus SC	OFDM	Subcarrier # -32 to 31 (11a/b/g) -64 to 63 (11n)	-675 to +675 °	-
Power versus SC	OFDM	Subcarrier # -32 to 31 (11a/b/g) -64 to 63 (11n)	-100 to +50 dBm	-
SC Constellation	All	Fixed	Fixed	-
Frequency error	All	-100 to 0 ms	-750 to +750 kHz	-
OFDM flatness	OFDM	Subcarrier # -32 to 31 (11a/b/g) -64 to 63 (11n)	-150 to +150 dB	-
OFDM linearity	OFDM	-5 to 10 mW	-5 to +10 mW	-
Symbol table	All	-	-	-

RBW

The RBW setting range depends on span as shown in Table D-10.

Table D-10: RBW setting range

Span (Hz)	Default value (Hz) /[Number of samples]	Minimum value (Hz) /[Number of samples]	Maximum value (Hz) /[Number of samples]
50 to 100	2 [1024]	1 [2048]	10 [128]
120 to 200	5 [512]	1 [4096]	20 [128]
250 to 500	10 [1024]	1 [8192]	50 [128]
600 to 1 k	20 [1024]	1 [16384]	100 [128]
1.2 k to 2 k	50 [512]	2 [16384]	200 [128]
2.5 k to 5 k	100 [1024]	5 [16384]	500 [128]
6 k to 10 k	100 [2048]	10 [16384]	1 k [128]
12 k to 20 k	200 [2048]	20 [16384]	2 k [128]
30 k to 50 k	300 [4096]	50 [16384]	5 k [128]
60 k to 100 k	500 [4096]	100 [16384]	10 k [128]
120 k to 200 k	1 k [4096]	200 [16384]	20 k [128]
250 k to 500 k	2 k [2048]	500 [16384]	50 k [128]
600 k to 1 M	5 k [2048]	1 k [16384]	100 k [128]
1.2 M to 2 M	10 k [4096]	1 k [32768]	200 k [128]
2.5 M to 5 M	20 k [4096]	1 k [65536]	500 k [256]
6 M to 10 M	50 k [2048]	1 k [65536]	1 M [128]
15 M	80 k [4096]	2 k [65536]	2 M [256]
20 M to 40 M	100 k [1024*N]	10 k [8192*N]	2 M [64*N]
50 M to 80 M	300 k [512*N]	10 k [8192*N]	2 M [64*N]
100 M to 150 M	500 k [256*N]	10 k [8192*N]	10 M [64*N]
200 M to 400 M	1 M [128*N]	10 k [8192*N]	10 M [64*N]
500 M to 800 M	2 M [128*N]	20 k [4096*N]	10 M [64*N]
1 G to 1.5 G	5 M [128*N]	50 k [2048*N]	20 M [64*N]
2 G to 3 G	10 M [128*N]	100 k [1024*N]	30 M [64*N]

* **N: Number of multi-frames, that is the value rounded off [(span)/(10 MHz)] to the positive infinity.**

Appendix E: SCPI Conformance Information

All commands in the RSA3000 Series analyzers are based on SCPI Version 1999.0. Table E-1 lists the commands that are defined in the SCPI 1999.0 Standard. The other commands not listed in the table are not defined in the SCPI 1999.0 Standard.

Table E- 1: SCPI 1999.0-defined commands

Command group	Command
IEEE common	*CAL?
	*CLS
	*ESE
	*ESR?
	*IDN?
	*OPC
	*RST
	*SRE
	*STB?
	*TST?
	*WAI
:ABORt	:ABORt
:CALibration	:CALibration [:ALL]? :AUTO
:HCOPy	:HCOPy :DESTination [:IMMediate]
:INITiate	:INITiate :CONTInuous [:IMMediate] :REStart
:INPut	:INPut :ATTenuation :AUTO :COUPling
:INSTrument	:INSTrument :CATalog [:SElect]
:MMEMory	:MMEMory :COpy :DElete :NAME

Table E- 1: SCPI 1999.0-defined commands (Cont.)

Command group	Command
:PROGram	:PROGram
	:CATalog?
	[:SElected] :DElete [:SElected]
	:EXECute
	:NAME
	:NUMBer
:SENSe	[:SENSe]
	:FREQuency
	:CENTer
	:STEP
	:AUTO
	[:INCrement]
	:SPAN
	:STARt
	:STOP
	:ROSCillator
:SOURce	
:STATus	:STATus
	:OPERation
	:CONDition?
	:ENABle
	[:EVENT]?
	NTRansition
	PTRansition
	:PRESet
	:QUESTionable
	:CONDition?
:ENABle	
[:EVENT]?	
NTRansition	
PTRansition	
:SYSTem	:SYSTem
	:DATE
	:ERRor
	:ALL?
	:CODE
	:ALL?
	[:NEXT]?
	:COUNT?
	[:NEXT]?
	:KLOCK
:PRESet	
:TIME	
:VERSion?	

Glossary and Index

Glossary

AM (Amplitude Modulation)

The process, or result of a process, in which the amplitude of a sine wave (the carrier) is varied in accordance with the instantaneous voltage of a second electrical signal (the modulating signal).

ASCII

Acronym for the American Standard Code for Information Interchange. Controllers transmit commands to the analyzer using ASCII character encoding.

Backus-Naur Form (BNF)

A standard notation system for command syntax diagrams. The syntax diagrams in this manual use BNF notation.

Controller

A computer or other device that sends commands to and accepts responses from the analyzer.

EVM (Error Vector Magnitude)

The magnitude of an error of an actual signal relative to an ideal signal in a constellation display.

FM (Frequency Modulation)

The process, or result of a process, in which the frequency of an electrical signal (the carrier) is varied in accordance with some characteristic of a second electrical signal (the modulating signal or modulation).

GPIB

Acronym for General Purpose Interface Bus, the common name for the communications interface system defined in IEEE Std 488.

IEEE

Acronym for the Institute for Electrical and Electronic Engineers.

PM (Pulse Modulation)

The process, or result of a process, in which the amplitude, phase, or duration of a pulse train (the carrier) is varied in accordance with some characteristic of a second electrical signal (the modulating signal or modulation).

Index

A

Abbreviations, commands, queries, and parameters, 2-6
:ABORt command group, 2-16
:ABORt commands, 2-89
Arguments, parameters, 2-4

B

Backus-Naur Form, 2-1
BNF (Backus-Naur form), 2-1

C

:CALCulate command group, 2-17
:CALCulate commands, 2-91
:CALibration command group, 2-18
:CALibration commands, 2-107
Case sensitivity, 2-9
Character chart, A-1
Command group
Commands
 chaining, 2-7
 rules for forming, 2-1
 structure of IEEE 488.2 commands, 2-10
 syntax, 2-1
:CONFigure command group, 2-18
:CONFigure command group (option), 2-19
:CONFigure commands, 2-119
:CONFigure Commands (Option), 2-131
:CONFigure:AC3Gpp subgroup (Option 23), 2-135
:CONFigure:DDEMod subgroup (Option 21), 2-132
:CONFigure:DLR5_3GPP subgroup (Option 27), 2-161
:CONFigure:DLR6_3GPP subgroup (Option 40), 2-180
:CONFigure:FL1XEVD0|:RL1XEVD0 subgroup (Option 26), 2-151
:CONFigure:FLCDMA2K|:RLCDMA2K subgroup (Option 25), 2-141
:CONFigure:GSMedge subgroup (Option 24), 2-137
:CONFigure:RFID subgroup (Option 21), 2-133
:CONFigure:SADLR5_3GPP subgroup (Option 27), 2-162
:CONFigure:SSource subgroup (Option 21), 2-134
:CONFigure:SWLAN subgroup, 2-176
:CONFigure:TD_SCDMA subgroup (Option 28), 2-168
:CONFigure:UL3Gpp subgroup (Option 23), 2-136
:CONFigure:ULR5_3GPP subgroup (Option 27), 2-167

:CONFigure:ULR6_3GPP subgroup (Option 40), 2-181
:CONFigure:WLAN subgroup (Option 29), 2-178
Conformance information, E-1
Creating commands, 2-3

D

Demod mode, definition, 2-14, 2-882
:DISPlay command group, 2-21, 2-25
:DISPlay commands, 2-183
:DISPlay commands (option), 2-249
:DISPlay:AC3Gpp subgroup (Option 23), 2-340
:DISPlay:CCDF subgroup, 2-186
:DISPlay:DDEMod subgroup (Option 21), 2-251
:DISPlay:DLR5_3GPP subgroup (Option 27), 2-444
:DISPlay:DLR6_3GPP subgroup (Option 40), 2-611
:DISPlay:FL1XEVD0:WAVEform subgroup (Option 26), 2-440
:DISPlay:FL1XEVD0|:RL1XEVD0:CCDF subgroup (Option 26), 2-417
:DISPlay:FL1XEVD0|:RL1XEVD0:DDEMod subgroup (Option 26), 2-424
:DISPlay:FL1XEVD0|:RL1XEVD0:SPECTrum subgroup (Option 26), 2-436
:DISPlay:FLCDMA2K|:RLCDMA2K:CCDF subgroup (Option 25), 2-390
:DISPlay:FLCDMA2K|:RLCDMA2K:DDEMod subgroup (Option 25), 2-397
:DISPlay:FLCDMA2K|:RLCDMA2K:SPECTrum subgroup (Option 25), 2-409
:DISPlay:GSMedge:DDEMod subgroup (Option 24), 2-365
:DISPlay:GSMedge:SPECTrum subgroup (Option 24), 2-380
:DISPlay:GSMedge:WAVEform subgroup (Option 24), 2-385
:DISPlay:M2WLAN:DDEMod subgroup (Option 29), 2-512
:DISPlay:M2WLAN:TFRrequency subgroup (Option 29), 2-535
:DISPlay:OView subgroup, 2-192
:DISPlay:PULSe:MVlew|:SVlew subgroup, 2-204
:DISPlay:PULSe:SPECTrum subgroup, 2-214
:DISPlay:PULSe:WAVEform subgroup, 2-219
:DISPlay:RFID:DDEMod subgroup (Option 21), 2-280
:DISPlay:RFID:SPECTrum subgroup (Option 21), 2-299

- :DISPlay:RFID:WAVeform subgroup (Option 21), 2-303
- :DISPlay:RLCDMA2K:WAVeform subgroup (Option 25), 2-413
- :DISPlay:SADLR5_3GPP subgroup (Option 27), 2-463
- :DISPlay:SPECTrum subgroup, 2-223
- :DISPlay:SSource:MVlew subgroup (Option 21), 2-307
- :DISPlay:SSource:SPECTrum subgroup (Option 21), 2-328
- :DISPlay:SSource:SVIew subgroup (Option 21), 2-316
- :DISPlay:SSource:TFRequency subgroup (Option 21), 2-332
- :DISPlay:SSource:WAVeform subgroup (Option 21), 2-336
- :DISPlay:SWLAN:DDEMod subgroup (Option 29), 2-546
- :DISPlay:SWLAN:SPECTrum subgroup (Option 29), 2-574
- :DISPlay:SWLAN:TFRequency subgroup (Option 29), 2-578
- :DISPlay:TD_SCDMA:DDEMod subgroup (Option 28), 2-482
- :DISPlay:TD_SCDMA:SPECTrum subgroup (Option 28), 2-508
- :DISPlay:TFRequency subgroup, 2-233
- :DISPlay:UL3Gpp subgroup (Option 23), 2-344
- :DISPlay:ULR5_3GPP subgroup (Option 27), 2-467
- :DISPlay:ULR6_3GPP subgroup (Option 40), 2-633
- :DISPlay:WAVeform subgroup, 2-245
- :DISPlay:WLAN:DDEMod subgroup (Option 29), 2-589
- :DISPlay:WLAN:SPECTrum subgroup (Option 29), 2-607
- :DISPlay[:VIEW] subgroup, 2-242

E

- Error codes, 3-17
 - commands, 3-18
 - device specific, 3-22
 - execution, 3-20
 - hardware, 3-22
 - query, 3-22
- Example, programming, 4-1

F

- :FETCh command group, 2-43
- :FETCh command group (option), 2-44
- :FETCh commands, 2-659

- :FETCh commands (Option), 2-687
- :FETCh commands for Option 21
- :FETCh:AC3Gpp subgroup (Option 23), 2-713
- :FETCh:DDEMod subgroup (Option 21), 2-688
- :FETCh:DLR5_3GPP subgroup (Option 27), 2-776
- :FETCh:DLR6_3GPP subgroup (Option 40), 2-850
- :FETCh:FL1XEVDQ|:RL1XEVDQ subgroup (Option 26), 2-752
- :FETCh:FLCDMA2K|:RLCDMA2K subgroup (Option 25), 2-732
- :FETCh:GSMedge subgroup (Option 24), 2-720
- :FETCh:M2WLAN subgroup (Option 29), 2-826
- :FETCh:RFID subgroup (Option 21), 2-694
- :FETCh:SADLR5_3GPP|:SAULR5_3GPP subgroup (Option 27), 2-782
- :FETCh:SSource subgroup (Option 21), 2-704
- :FETCh:SWLAN subgroup (Option 29), 2-833
- :FETCh:TD_SCDMA subgroup (Option 28), 2-803
- :FETCh:UL3Gpp subgroup (Option 23), 2-714
- :FETCh:ULR5_3GPP subgroup (Option 27), 2-797
- :FETCh:ULR6_3GPP subgroup (Option 40), 2-856
- :FETCh:WLAN subgroup (Option 29), 2-841
- :FORMat command group, 2-48
- :FORMat commands, 2-865

G

GPIB

- configurations, 1-5
- connection rules, 1-5
- interface specification, B-1
- setting GPIB parameters, 1-6

H

- :HCOPy command group, 2-48
- :HCOPy commands, 2-867
- Hierarchy tree, 2-2
- Horizontal scaling, note, 2-184

I

- IEEE 488.2 Common Commands, 2-10
- IEEE common command group, 2-16
- IEEE common commands, 2-79
- IEEE Std 488.2-1987, 2-1
- Initialization settings, C-1
- :INITiate command group, 2-49
- :INITiate commands, 2-871
- :INPut command group, 2-49
- :INPut commands, 2-875

:INSTRument command group, 2-49
 :INSTRument commands, 2-881
 Interface message, B-3

M

MAXimum for numeric parameters, 2-5
 Measurement modes, 2-13, 2-882
 MINimum for numeric parameters, 2-5
 :MMEMory command group, 2-50
 :MMEMory commands, 2-885
 Mnemonics, Constructed, 2-11
 Mode, measurement, 2-13, 2-882

N

Note on horizontal scaling, 2-184

O

:OUTPut command group, 2-51
 :OUTPut commands, 2-909

P

Parameter types used in syntax descriptions, 2-4
 :PROGram command group, 2-51
 :PROGram commands, 2-911
 Programming example, 4-1

Q

Queries, 2-3
 Query Responses, 2-3
 Queues
 event, 3-12
 output, 3-12
 Quotes, 2-9

R

:READ command group, 2-51
 :READ commands, 2-917
 :READ commands (option), 2-945
 :READ:AC3Gpp subgroup (Option 23), 2-962
 :READ:DDEMod subgroup (Option 21), 2-947
 :READ:FL1XEVD0|:RL1XEVD0 subgroup
 (Option 26), 2-988
 :READ:FLCDMA2K|:RLCDMA2K subgroup
 (Option 25), 2-974

:READ:GSMedge subgroup (Option 24), 2-963
 :READ:RFID subgroup (Option 21), 2-953
 :READ:SADLR5_3GPP|:SAULR5_3GPP subgroup
 (Option 27), 2-1002
 :READ:SSource subgroup (Option 21), 2-958
 :READ:SWLAN subgroup (Option 29), 2-1028
 :READ:TD_SCDMA subgroup (Option 28), 2-1017
 :READ:WLAN subgroup (Option 29), 2-1030

Registers

 Event Status Enable Register (ESER), 3-9
 Operation Condition Register (OCR), 3-8
 Operation Event Register (OEVR), 3-8
 Service Request Enable Register (SRER), 3-10
 Standard Event Status Register (SESR), 3-7
 Status Byte Register (SRB), 3-6

Retrieving response message, 2-1557

Rules

 command forming, 2-1
 for using SCPI commands, 2-9

S

S/A mode, definition, 2-13, 2-882
 Scaling, horizontal, note, 2-184

SCPI

 abbreviating, 2-6
 chaining commands, 2-7
 commands, 2-2
 conformance information, E-1
 general rules, 2-9
 parameter types, 2-4
 subsystem hierarchy tree, 2-2

SCPI commands and queries syntax, 2-2

 creating commands, 2-3
 creating queries, 2-3

:SENSe command group, 2-55
 :SENSe command group (option), 2-59
 :SENSe commands, 2-1035
 :SENSe commands (option), 2-1119
 [:SENSe]:AC3Gpp subgroup (Option 23), 2-1195
 [:SENSe]:ACPower subgroup, 2-1036
 [:SENSe]:ADEMod subgroup, 2-1040
 [:SENSe]:AVERage subgroup, 2-1048
 [:SENSe]:BSIZe subgroup, 2-1051
 [:SENSe]:CCDF subgroup, 2-1052
 [:SENSe]:CFRequency subgroup, 2-1055
 [:SENSe]:CHPower subgroup, 2-1056
 [:SENSe]:CNRatio subgroup, 2-1059
 [:SENSe]:CORRection subgroup, 2-1064
 [:SENSe]:DDEMod subgroup (Option 21), 2-1122
 [:SENSe]:DLR5_3GPP subgroup (Option 27), 2-1355
 [:SENSe]:DLR6_3GPP subgroup (Option 40), 2-1490

- [:SENSe]:EBWidth subgroup, 2-1069
- [:SENSe]:FEED subgroup, 2-1071
- [:SENSe]:FL1XEVD0:PVTime subgroup (Option 26), 2-1338
- [:SENSe]:FL1XEVD0|:RL1XEVD0 subgroup (Option 26), 2-1284
- [:SENSe]:FL1XEVD0|:RL1XEVD0:ACPower subgroup (Option 26), 2-1291
- [:SENSe]:FL1XEVD0|:RL1XEVD0:CCDF subgroup (Option 26), 2-1295
- [:SENSe]:FL1XEVD0|:RL1XEVD0:CDPower subgroup (Option 26), 2-1297
- [:SENSe]:FL1XEVD0|:RL1XEVD0:CHPower subgroup (Option 26), 2-1306
- [:SENSe]:FL1XEVD0|:RL1XEVD0:IM subgroup (Option 26), 2-1310
- [:SENSe]:FL1XEVD0|:RL1XEVD0:MACCuracy subgroup (Option 26), 2-1315
- [:SENSe]:FL1XEVD0|:RL1XEVD0:OBWidth subgroup (Option 26), 2-1327
- [:SENSe]:FL1XEVD0|:RL1XEVD0:PCCHannel subgroup (Option 26), 2-1329
- [:SENSe]:FL1XEVD0|:RL1XEVD0:SEMask subgroup (Option 26), 2-1344
- [:SENSe]:FLCDMA2K|:RLCDMA2K subgroup (Option 25), 2-1219
- [:SENSe]:FLCDMA2K|:RLCDMA2K:ACPower subgroup (Option 25), 2-1226
- [:SENSe]:FLCDMA2K|:RLCDMA2K:CCDF subgroup (Option 25), 2-1230
- [:SENSe]:FLCDMA2K|:RLCDMA2K:CDPower subgroup (Option 25), 2-1232
- [:SENSe]:FLCDMA2K|:RLCDMA2K:CHPower subgroup (Option 25), 2-1241
- [:SENSe]:FLCDMA2K|:RLCDMA2K:IM subgroup (Option 25), 2-1245
- [:SENSe]:FLCDMA2K|:RLCDMA2K:MACCuracy subgroup (Option 25), 2-1250
- [:SENSe]:FLCDMA2K|:RLCDMA2K:OBWidth subgroup (Option 25), 2-1261
- [:SENSe]:FLCDMA2K|:RLCDMA2K:PCCHannel subgroup (Option 25), 2-1263
- [:SENSe]:FLCDMA2K|:RLCDMA2K:SEMask subgroup (Option 25), 2-1277
- [:SENSe]:FREQuency subgroup, 2-1072
- [:SENSe]:GSMedge subgroup (Option 24), 2-1205
- [:SENSe]:M2WLAN subgroup (Option 29), 2-1457
- [:SENSe]:OBWidth subgroup, 2-1080
- [:SENSe]:PULSe subgroup, 2-1082
- [:SENSe]:PULSe:OBWidth:PERCent(?), 2-1089
- [:SENSe]:RFID subgroup (Option 21), 2-1141
- [:SENSe]:RLCDMA2K:PVTime subgroup (Option 25), 2-1271
- [:SENSe]:ROSCillator subgroup, 2-1092
- [:SENSe]:SADLR5_3GPP:MCAClr subgroup (Option 27), 2-1378
- [:SENSe]:SADLR5_3GPP|:SAULR5_3GPP:SEMask subgroup (Option 27), 2-1385
- [:SENSe]:SADLR5_3GPP|:SAULR5_3GPP:ACLR subgroup (Option 27), 2-1366
- [:SENSe]:SADLR5_3GPP|:SAULR5_3GPP:CRequency subgroup (Option 27), 2-1371
- [:SENSe]:SADLR5_3GPP|:SAULR5_3GPP:CHPower subgroup (Option 27), 2-1373
- [:SENSe]:SADLR5_3GPP|:SAULR5_3GPP:EBWidth subgroup (Option 27), 2-1376
- [:SENSe]:SADLR5_3GPP|:SAULR5_3GPP:OBWidth subgroup (Option 27), 2-1383
- [:SENSe]:SPECTrum subgroup, 2-1093
- [:SENSe]:SPURious subgroup, 2-1111
- [:SENSe]:SSource subgroup (Option 21), 2-1170
- [:SENSe]:SWLAN subgroup (Option 29), 2-1467
- [:SENSe]:TD_SCDMA subgroup (Option 28), 2-1403
- [:SENSe]:TD_SCDMA:ACLR subgroup (Option 28), 2-1407
- [:SENSe]:TD_SCDMA:ACQuisition subgroup (Option 28), 2-1409
- [:SENSe]:TD_SCDMA:ANALysis subgroup (Option 28), 2-1412
- [:SENSe]:TD_SCDMA:CHPower subgroup (Option 28), 2-1419
- [:SENSe]:TD_SCDMA:IM subgroup (Option 28), 2-1422
- [:SENSe]:TD_SCDMA:MACCuracy subgroup (Option 28), 2-1426
- [:SENSe]:TD_SCDMA:MODulation subgroup (Option 28), 2-1431
- [:SENSe]:TD_SCDMA:OBWidth subgroup (Option 28), 2-1436
- [:SENSe]:TD_SCDMA:SElect subgroup (Option 28), 2-1439
- [:SENSe]:TD_SCDMA:SEMask subgroup (Option 28), 2-1443
- [:SENSe]:TD_SCDMA:SPECTrum subgroup (Option 28), 2-1450
- [:SENSe]:TD_SCDMA:STABLE subgroup (Option 28), 2-1452
- [:SENSe]:TD_SCDMA:TOOMask subgroup (Option 28), 2-1454
- [:SENSe]:TRANsient subgroup, 2-1115
- [:SENSe]:UL3Gpp subgroup (Option 23), 2-1197
- [:SENSe]:ULR5_3GPP subgroup (Option 27), 2-1392

[[:SENSe]:ULR6_3GPP subgroup (Option 27), 2-1504

[[:SENSe]:WLAN subgroup (Option 29), 2-1479

Setting

 range of RBW, D-8

 range of scale, D-1

SI prefix and unit, 2-8

Special characters, 2-6

:STATus command group, 2-76

:STATus commands, 2-1519

Syntax, command, 2-1

:SYSTem command group, 2-76

:SYSTem commands, 2-1527

T

TekVISA, 1-8

 installing, 1-8

Time mode, definition, 2-14, 2-883

:TRACe command group, 2-77

:TRACe commands, 2-1537

:TRIGger command group, 2-77

:TRIGger commands, 2-1543

U

Unit and SI prefix, 2-8

:UNIT command group, 2-78

:UNIT commands, 2-1555

